

ON Semiconductor

Is Now

onsemi™

To learn more about onsemi™, please visit our website at
www.onsemi.com

onsemi and **onsemi** and other names, marks, and brands are registered and/or common law trademarks of Semiconductor Components Industries, LLC dba "**onsemi**" or its affiliates and/or subsidiaries in the United States and/or other countries. **onsemi** owns the rights to a number of patents, trademarks, copyrights, trade secrets, and other intellectual property. A listing of **onsemi** product/patent coverage may be accessed at www.onsemi.com/site/pdf/Patent-Marking.pdf. **onsemi** reserves the right to make changes at any time to any products or information herein, without notice. The information herein is provided "as-is" and **onsemi** makes no warranty, representation or guarantee regarding the accuracy of the information, product features, availability, functionality, or suitability of its products for any particular purpose, nor does **onsemi** assume any liability arising out of the application or use of any product or circuit, and specifically disclaims any and all liability, including without limitation special, consequential or incidental damages. Buyer is responsible for its products and applications using **onsemi** products, including compliance with all laws, regulations and safety requirements or standards, regardless of any support or applications information provided by **onsemi**. "Typical" parameters which may be provided in **onsemi** data sheets and/or specifications can and do vary in different applications and actual performance may vary over time. All operating parameters, including "Typicals" must be validated for each customer application by customer's technical experts. **onsemi** does not convey any license under any of its intellectual property rights nor the rights of others. **onsemi** products are not designed, intended, or authorized for use as a critical component in life support systems or any FDA Class 3 medical devices or medical devices with a same or similar classification in a foreign jurisdiction or any devices intended for implantation in the human body. Should Buyer purchase or use **onsemi** products for any such unintended or unauthorized application, Buyer shall indemnify and hold **onsemi** and its officers, employees, subsidiaries, affiliates, and distributors harmless against all claims, costs, damages, and expenses, and reasonable attorney fees arising out of, directly or indirectly, any claim of personal injury or death associated with such unintended or unauthorized use, even if such claim alleges that **onsemi** was negligent regarding the design or manufacture of the part. **onsemi** is an Equal Opportunity/Affirmative Action Employer. This literature is subject to all applicable copyright laws and is not for resale in any manner. Other names and brands may be claimed as the property of others.

NUF2900MN

Two Line EMI Filter with ESD Protection for High Speed Data Interface

NUF2900MN is a two line EMI filter with ESD protection designed for high speed data interface. It offers greater than -30 dB attenuation at frequencies from 800 MHz to 6.0 GHz while supporting data rates as high as 250 Mbps (125 MHz).

Features

- Provides EMI Filtering and ESD Protection
- Maximum Data Rate up to 250 Mbps
- Maximum ESD Rating of:
5.0 kV (Contact)
- DFN8, 2x2 mm Package
- Moisture Sensitivity Level 1
- ESD Ratings: Machine Model = C
Human Body Model = 3B
- This is a Pb-Free Device*

Applications

- EMI Filtering and ESD Protection for High Speed Data Interface
- Serializer / Deserializer
- Camera Imager Interface
- High Resolution Color LCD Display



ON Semiconductor®

<http://onsemi.com>

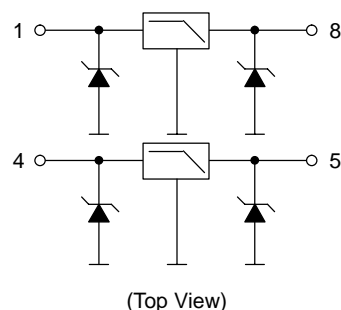

MARKING DIAGRAM

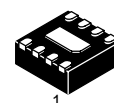

**DFN8
CASE 506AA
PLASTIC**

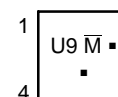

U9 = Specific Device Code
M = Date Code
▪ = Pb-Free Package

(Note: Microdot may be in either location)

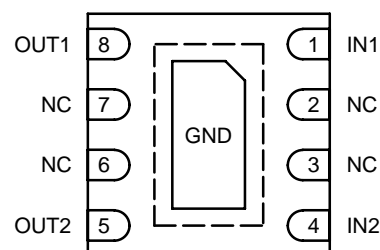

(Bottom View)

ORDERING INFORMATION

Device	Package	Shipping†
NUF2900MNT1G	DFN8 (Pb-Free)	3000/Tape & Reel

†For information on tape and reel specifications, including part orientation and tape sizes, please refer to our Tape and Reel Packaging Specification Brochure, BRD8011/D.

*For additional information on our Pb-Free strategy and soldering details, please download the ON Semiconductor Soldering and Mounting Techniques Reference Manual, SOLDERRM/D.

NUF2900MN

MAXIMUM RATINGS

Parameter	Symbol	Value	Unit
ESD Discharge IEC61000-4-2 Contact Discharge	V_{PP}	5.0	kV
Operating Temperature Range	T_{OP}	-40 to 85	°C
Storage Temperature Range	T_{stg}	-55 to 150	°C
Maximum Lead Temperature for Soldering Purposes (1.8 in from case for 10 s)	T_L	260	°C

Stresses exceeding Maximum Ratings may damage the device. Maximum Ratings are stress ratings only. Functional operation above the Recommended Operating Conditions is not implied. Extended exposure to stresses above the Recommended Operating Conditions may affect device reliability.

ELECTRICAL CHARACTERISTICS ($T_J = 25^\circ\text{C}$ unless otherwise noted)

Parameter	Test Conditions	Symbol	Min	Typ	Max	Unit
Maximum Reverse Working Voltage		V_{RWM}			5.0	V
Breakdown Voltage	$I_R = 1.0 \text{ mA}$	V_{BR}	6.0	7.0	8.3	V
Leakage Current	$V_{RWM} = 3.3 \text{ V}$	I_R			0.1	μA
Resistance		R_A		3.6	5.0	Ω
Effective Capacitance (Note 1)		C_{eff}		10.4		pF
Inductance		L		22.1		nH
Capacitance (Note 2)		C_{line}		33		pF
Cut-Off Frequency (Note 3)	Above this frequency, appreciable attenuation occurs	f_{3dB}		350		MHz

1. Refer to "Effective Capacitance Calculation" below.
2. Measured at 25°C , $V_R = 0 \text{ V}$, $f = 1.0 \text{ MHz}$.
3. 50Ω source and 50Ω load termination.

Effective Capacitance Calculation

The capacitance of the NUF2900MN can be determined a number of ways. When evaluated using low frequency, low current capacitance measurement equipment C_{LINE} (line capacitance), it is determined to be approximately 33 pF. When used in systems that have signal rise and fall times of 1 ns or less $C_{EFFECTIVE}$ (effective capacitance), it is closer to 10.4 pF.

If the rise and fall times of a signal is determined by the capacitance of the NUF2900MN, then an "effective" capacitance can be calculated using the following function based on a simple "RC" combination.

$$V_{OUT} = V_{IN} \left(1 - e^{-\frac{t}{R_{Termination} C_{Effective}}} \right)$$

The rise time "t" is approximately 1.08 ns with $V_{OUT} \sim 88\%$ of V_{IN} where the network impedance is 50Ω . When solving for $C_{EFFECTIVE}$, the capacitance is found to be 10.4 pF.

$$C_{Effective} = \frac{-t}{R \times \ln\left(1 - \frac{V_{OUT}}{V_{IN}}\right)}$$

$$C_{Effective} = \frac{-1.08\text{ns}}{50 \times \ln(1 - 0.88)}$$

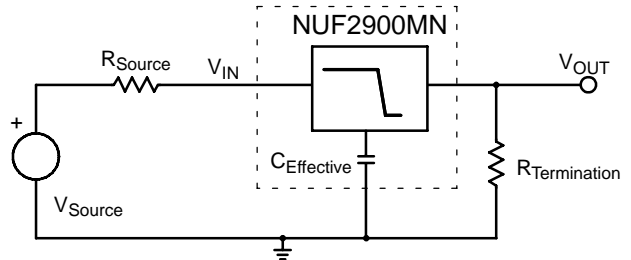

If the data signal source has a rise and fall time slower than 1 ns, the NUF2900MN will have a filtered output with a similar rise and fall time. $C_{EFFECTIVE}$ will scale accordingly as rise/fall times increase until it reaches C_{LINE} .

NUF2900MN

TYPICAL PERFORMANCE CURVES

($T_A = 25^\circ\text{C}$ unless otherwise specified)

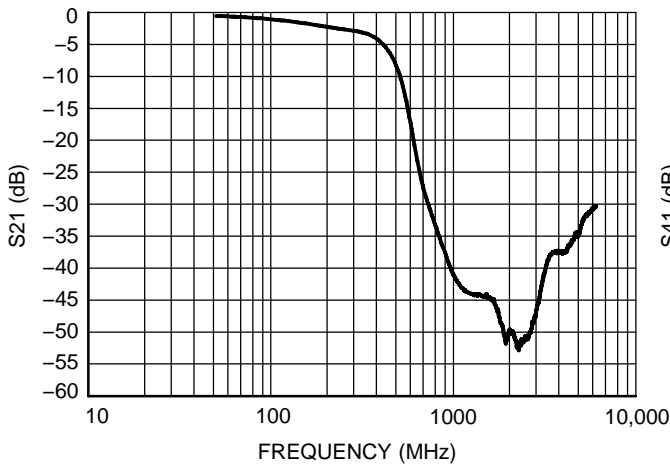

Figure 1. Typical Insertion Loss Characteristic (S21 Measurement)

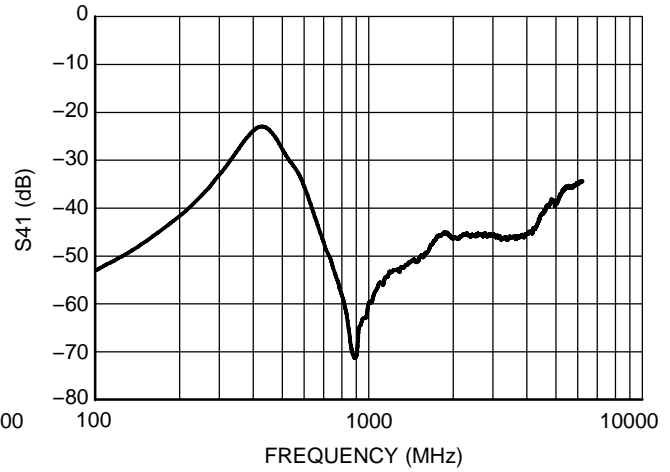

Figure 2. Analog Crosstalk Curve (S41 Measurement - 50 Ω Load)

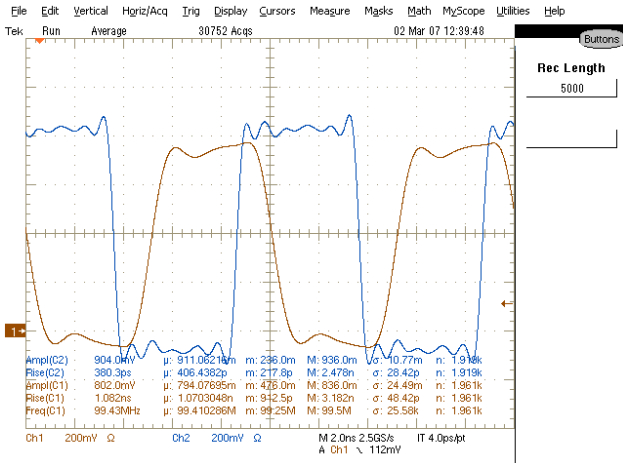

Figure 3. Actual High Speed (100 MHz) Pulse Wave Form of NUF2900MN

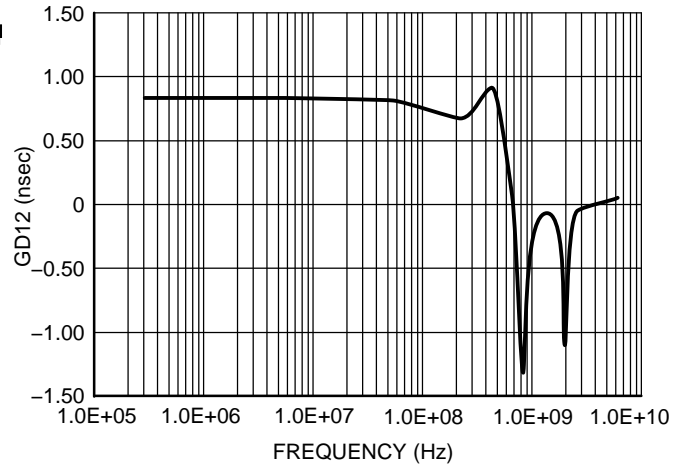

Figure 4. Group Delay Characteristics Simulation for NUF2900MN

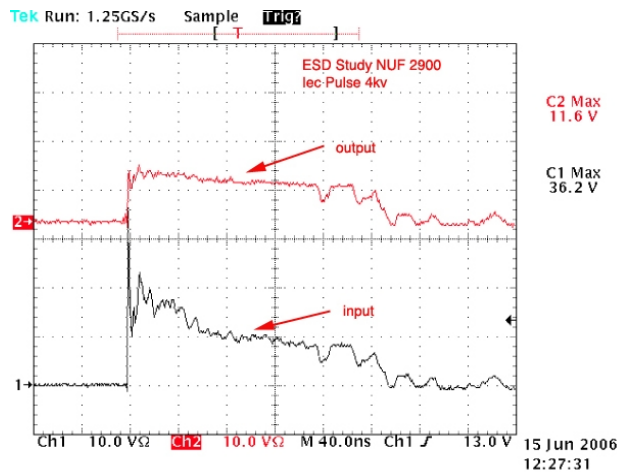
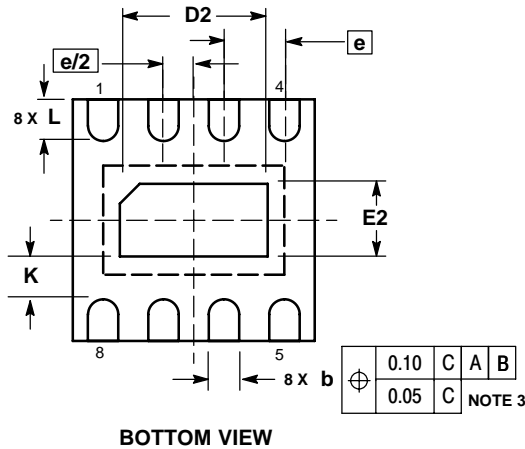
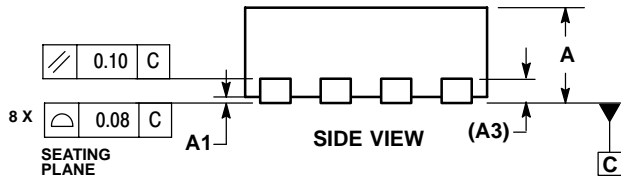
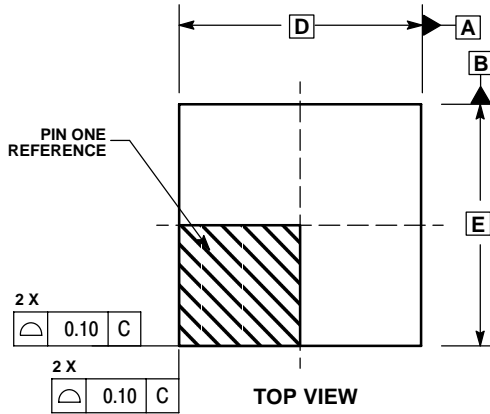

Figure 5. ESD Scope Trace - IEC Waveform Actual Response of NUF2900MN

NUF2900MN

PACKAGE DIMENSIONS

DFN8
CASE 506AA-01
ISSUE D



NOTES:

1. DIMENSIONING AND TOLERANCING PER ASME Y14.5M, 1994 .
2. CONTROLLING DIMENSION: MILLIMETERS.
3. DIMENSION b APPLIES TO PLATED TERMINAL AND IS MEASURED BETWEEN 0.25 AND 0.30 MM FROM TERMINAL.
4. COPLANARITY APPLIES TO THE EXPOSED PAD AS WELL AS THE TERMINALS.

DIM	MILLIMETERS	
	MIN	MAX
A	0.80	1.00
A1	0.00	0.05
A3	0.20	REF
b	0.20	0.30
D	2.00	BSC
D2	1.10	1.30
E	2.00	BSC
E2	0.70	0.90
e	0.50	BSC
K	0.20	---
L	0.25	0.35

ON Semiconductor and **ON** are registered trademarks of Semiconductor Components Industries, LLC (SCILLC). SCILLC reserves the right to make changes without further notice to any products herein. SCILLC makes no warranty, representation or guarantee regarding the suitability of its products for any particular purpose, nor does SCILLC assume any liability arising out of the application or use of any product or circuit, and specifically disclaims any and all liability, including without limitation special, consequential or incidental damages. "Typical" parameters which may be provided in SCILLC data sheets and/or specifications can and do vary in different applications and actual performance may vary over time. All operating parameters, including "Typicals" must be validated for each customer application by customer's technical experts. SCILLC does not convey any license under its patent rights nor the rights of others. SCILLC products are not designed, intended, or authorized for use as components in systems intended for surgical implant into the body, or other applications intended to support or sustain life, or for any other application in which the failure of the SCILLC product could create a situation where personal injury or death may occur. Should Buyer purchase or use SCILLC products for any such unintended or unauthorized application, Buyer shall indemnify and hold SCILLC and its officers, employees, subsidiaries, affiliates, and distributors harmless against all claims, costs, damages, and expenses, and reasonable attorney fees arising out of, directly or indirectly, any claim of personal injury or death associated with such unintended or unauthorized use, even if such claim alleges that SCILLC was negligent regarding the design or manufacture of the part. SCILLC is an Equal Opportunity/Affirmative Action Employer. This literature is subject to all applicable copyright laws and is not for resale in any manner.

PUBLICATION ORDERING INFORMATION

LITERATURE FULFILLMENT:
Literature Distribution Center for ON Semiconductor
P.O. Box 5163, Denver, Colorado 80217 USA
Phone: 303-675-2175 or 800-344-3860 Toll Free USA/Canada
Fax: 303-675-2176 or 800-344-3867 Toll Free USA/Canada
Email: orderlit@onsemi.com

N. American Technical Support: 800-282-9855 Toll Free
USA/Canada
Europe, Middle East and Africa Technical Support:
Phone: 421 33 790 2910
Japan Customer Focus Center
Phone: 81-3-5773-3850

ON Semiconductor Website: www.onsemi.com
Order Literature: <http://www.onsemi.com/orderlit>

For additional information, please contact your local Sales Representative