

User Manual

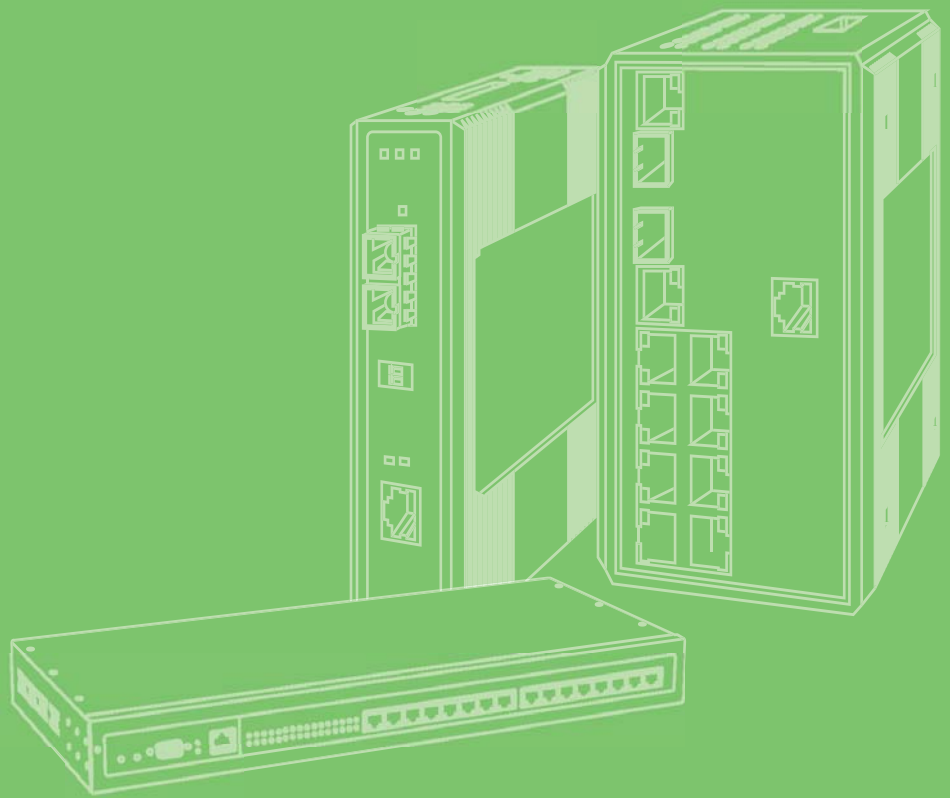

EKI-1526/N/I/TI

EKI-1528/N/I/TI

8/16 port RS-232/422/485
Serial Device Server (Rackmount)

ADVANTECH

Enabling an Intelligent Planet

Copyright

The documentation and the software included with this product are copyrighted 2017 by Advantech Co., Ltd. All rights are reserved. Advantech Co., Ltd. reserves the right to make improvements in the products described in this manual at any time without notice. No part of this manual may be reproduced, copied, translated or transmitted in any form or by any means without the prior written permission of Advantech Co., Ltd. Information provided in this manual is intended to be accurate and reliable. However, Advantech Co., Ltd. assumes no responsibility for its use, nor for any infringements of the rights of third parties, which may result from its use.

Acknowledgments

Intel and Pentium are trademarks of Intel Corporation.

Microsoft Windows and MS-DOS are registered trademarks of Microsoft Corp.

All other product names or trademarks are properties of their respective owners.

Product Warranty (5 years)

Advantech warrants to you, the original purchaser, that each of its products will be free from defects in materials and workmanship for five years from the date of purchase.

This warranty does not apply to any products which have been repaired or altered by persons other than repair personnel authorized by Advantech, or which have been subject to misuse, abuse, accident or improper installation. Advantech assumes no liability under the terms of this warranty as a consequence of such events.

Because of Advantech's high quality-control standards and rigorous testing, most of our customers never need to use our repair service. If an Advantech product is defective, it will be repaired or replaced at no charge during the warranty period. For out of-warranty repairs, you will be billed according to the cost of replacement materials, service time and freight. Please consult your dealer for more details.

If you think you have a defective product, follow these steps:

1. Collect all the information about the problem encountered. (For example, CPU speed, Advantech products used, other hardware and software used, etc.) Note anything abnormal and list any on screen messages you get when the problem occurs.
2. Call your dealer and describe the problem. Please have your manual, product, and any helpful information readily available.
3. If your product is diagnosed as defective, obtain an RMA (return merchandise authorization) number from your dealer. This allows us to process your return more quickly.
4. Carefully pack the defective product, a fully-completed Repair and Replacement Order Card and a photocopy proof of purchase date (such as your sales receipt) in a shippable container. A product returned without proof of the purchase date is not eligible for warranty service.
5. Write the RMA number visibly on the outside of the package and ship it prepaid to your dealer.

Part No. 2009152610

Printed in Taiwan

Edition 1

June 2018

Declaration of Conformity

CE

This product has passed the CE test for environmental specifications when shielded cables are used for external wiring. We recommend the use of shielded cables. This kind of cable is available from Advantech. Please contact your local supplier for ordering information.

This product has passed the CE test for environmental specifications. Test conditions for passing included the equipment being operated within an industrial enclosure. In order to protect the product from being damaged by ESD (Electrostatic Discharge) and EMI leakage, we strongly recommend the use of CE-compliant industrial enclosure products.

FCC Class A

Note: This equipment has been tested and found to comply with the limits for a Class A digital device, pursuant to part 15 of the FCC Rules. These limits are designed to provide reasonable protection against harmful interference when the equipment is operated in a commercial environment. This equipment generates, uses, and can radiate radio frequency energy and, if not installed and used in accordance with the instruction manual, may cause harmful interference to radio communications. Operation of this equipment in a residential area is likely to cause harmful interference in which case the user will be required to correct the interference at his own expense.

Technical Support and Assistance

1. Visit the Advantech web site at www.advantech.com/support where you can find the latest information about the product.
2. Contact your distributor, sales representative, or Advantech's customer service center for technical support if you need additional assistance. Please have the following information ready before you call:
 - Product name and serial number
 - Description of your peripheral attachments
 - Description of your software (operating system, version, application software, etc.)
 - A complete description of the problem
 - The exact wording of any error messages

Warnings, Cautions and Notes

Warning! Warnings indicate conditions, which if not observed, can cause personal injury!



Caution! Cautions are included to help you avoid damaging hardware or losing data.



Note! Notes provide optional additional information.



This symbol is intended to alert the user to the presence of uninsulated dangerous voltage within the product's enclosure that may be of sufficient magnitude to constitute a risk of electric shock to persons.

Ce symbole est prévu pour alerter l'utilisateur de la présence d'une tension dangereuse non isolée à l'intérieur du boîtier du produit, qui peut être important pour constituer un risque d'électrocution.



This symbol is intended to alert the user to the potential presence of a hot surface.

Ce symbole est prévu pour alerter l'utilisateur de la présence potentielle d'une surface chaude.

Safety Instructions

- Read these safety instructions carefully.
- Keep this User Manual for later reference.
- Disconnect this equipment from any AC outlet before cleaning. Use a damp cloth. Do not use liquid or spray detergents for cleaning.
- For plug-in equipment, the power outlet socket must be located near the equipment and must be easily accessible.
- Keep this equipment away from humidity.
- Put this equipment on a reliable surface during installation. Dropping it or letting it fall may cause damage.
- The openings on the enclosure are for air convection. Protect the equipment from overheating. **DO NOT COVER THE OPENINGS.**
- Make sure the voltage of the power source is correct before connecting the equipment to the power outlet.
- Position the power cord so that people cannot step on it. Do not place anything over the power cord.
- All cautions and warnings on the equipment should be noted.
- If the equipment is not used for a long time, disconnect it from the power source to avoid damage by transient overvoltage.
- Never pour any liquid into an opening. This may cause fire or electrical shock.
- Never open the equipment. For safety reasons, the equipment should be opened only by qualified service personnel.
- If one of the following situations arises, get the equipment checked by service personnel:
 - The power cord or plug is damaged.
 - Liquid has penetrated into the equipment.
 - The equipment has been exposed to moisture.
 - The equipment does not work well, or you cannot get it to work according to the user's manual.
 - The equipment has been dropped and damaged.
 - The equipment has obvious signs of breakage.
- **DO NOT LEAVE THIS EQUIPMENT IN AN ENVIRONMENT WHERE THE STORAGE TEMPERATURE MAY GO BELOW -20° C (-4° F) OR ABOVE 60° C (140° F). THIS COULD DAMAGE THE EQUIPMENT. THE EQUIPMENT SHOULD BE IN A CONTROLLED ENVIRONMENT.**
- **CAUTION: DANGER OF EXPLOSION IF BATTERY IS INCORRECTLY REPLACED. REPLACE ONLY WITH THE SAME OR EQUIVALENT TYPE RECOMMENDED BY THE MANUFACTURER, DISCARD USED BATTERIES ACCORDING TO THE MANUFACTURER'S INSTRUCTIONS.**

Warning! *This equipment is not suitable for use in locations where children are likely to be present.*



Safety Precaution - Static Electricity

Follow these simple precautions to protect yourself from harm and the products from damage.

- To avoid electrical shock, always disconnect the power from your PC chassis before you work on it. Don't touch any components on the CPU card or other cards while the PC is on.
- Disconnect power before making any configuration changes. The sudden rush of power as you connect a jumper or install a card may damage sensitive electronic components.

Safety Precaution - Power Cord Safety

Please read the following safety information carefully before installing the switch:

Warning! *Installation and removal of the unit must be carried out by qualified personnel only.*



- The unit must be connected to an earthed (grounded) outlet to comply with international safety standards.
- The unit must be powered by using listed power source, rated 12-48Vdc, 0.7A minimum and Tma 75°C comply with LPS or PS2.
- Do not connect the unit to an A.C. outlet (power supply) without an earth (ground) connection.
- The socket outlet must be near to the unit and easily accessible. You can only remove power from the unit by disconnecting the power cord from the outlet.

Précaution de Sécurité - Sécurité du Cordon d'Alimentation

Veuillez lire attentivement les informations de sécurité suivantes avant d'installer le commutateur:

Attention! *L'installation et le retrait de l'unité doivent être effectués uniquement par du personnel qualifié.*



- L'appareil doit être connecté à une prise de terre (mise à la terre) pour se conformer aux normes de sécurité internationales.
- L'appareil doit être alimentée en utilisant une source d'alimentation répertoriée, nominale 12-48Vdc, 0,7A minimum et TMA 75°C conforme à LPS ou PS2.
- Ne connectez pas l'appareil à une prise de courant alternatif CA (alimentation) sans une connexion à la terre.
- La prise de courant doit être proche de l'appareil et facilement accessible. Vous ne pouvez couper l'alimentation de l'appareil qu'en débranchant le cordon d'alimentation dès la prise de courant.

Safety Precaution - Shock Hazard

Electrical current from power, telephone, and communication cables is hazardous.

To avoid a shock hazard:

- Do not connect or disconnect any cables or perform installation, maintenance, or reconfiguration of this product during an electrical storm.
- Connect all power cords to a properly wired and grounded power source.
- Connect to properly wired power sources any equipment that will be attached to this product.
- When possible, use one hand only to connect or disconnect signal cables.
- Never turn on any equipment when there is evidence of fire, water, or structural damage.
- Disconnect the attached AC power cords, DC power sources, network connections, telecommunications systems, and serial cables before you open the device covers, unless you are instructed otherwise in the installation and configuration procedures.
- Connect and disconnect cables as described in the following table when you install, move, or open covers on this product or attached devices.

Risque d'Électrocution

Le courant électrique provenant des câbles d'alimentation, de téléphone et de communication est dangereux.

Pour éviter un risque d'électrocution:

- Ne connectez ou déconnectez aucun câble, n'effectuez aucune installation, maintenance ou reconfiguration de ce produit pendant un orage électrique.
- Connectez tous les cordons d'alimentation à une source d'alimentation correctement câblée et mise à la terre.
- Branchez tous les équipements connectés à ce produit sur des sources d'alimentation correctement câblés.
- Si possible, utilisez une seule main pour connecter ou déconnecter les câbles de signal.
- Ne mettez jamais un équipement sous tension en cas d'incendie ou d'inondation, ou en présence de dommages matériels.
- Débranchez les cordons d'alimentation connectés au courant alternatif(CA), les sources d'alimentation au courant continu(CC), les connexions de réseaux, les systèmes de télécommunication et les câbles série avant d'ouvrir les capots de l'appareil, sauf indication contraire dans les procédures d'installation et de configuration.
- Connectez et déconnectez les câbles comme indiqué dans le tableau suivant lorsque vous installez, déplacez ou ouvrez des capots sur ce produit ou sur des appareils connectés.

Notice

About this manual The illustrations as shown in this manual are for instructional purposes only. EKI-1526(TI) | 1528(TI) are suitable for installation in Information Technology Rooms in accordance with Article 645 of the National Electrical Code and NFPA 75. The device can only be used in a fixed location such as a telecommunication centre, a dedicated computer room. When you install the device, ensure that the protective earthing connection of the socket-outlet is verified by a skilled professional.

Document Feedback

To assist us in making improvements to this manual, we would welcome comments and constructive criticism. Please send all such - in writing to:
ICG.Support@advantech.com.tw

Packing List

Before setting up the system, check that the items listed below are included and in good condition. If any item does not accord with the table, please contact your dealer immediately.

- One 8 or 16-port serial device server
- EKI-1500 driver utility and documentation CD
- Rack mount kits, including two L-shape metal plates and twelve screws

Technical Support and Assistance

1. Visit the Advantech web site at www.advantech.com/support where you can find the latest information about the product.
2. Contact your distributor, sales representative, or Advantech's customer service center for technical support if you need additional assistance. Please have the following information ready before you call:
 - Product name and serial number
 - Description of your peripheral attachment
 - Description of your software (operating system, version, application software, etc.)
 - A complete description of the problem
 - The exact wording of any error messages

Regional Service & Customization Centers

China Kunshan 86-512-5777-5666	Taiwan Taipei 886-2-2792-7818	Netherlands Eindhoven 31-40-267-7000	Poland Warsaw 48-22-33-23-740 / 41	USA/ Canada Milpitas, CA 1-408-519-3898
---	--	---	---	--

Worldwide Offices

Greater China China Toll Free 800-810-0345 Beijing 86-10-6298-4346 Shanghai 86-21-3632-1616 Shenzhen 86-755-8212-4222 Chengdu 86-28-8545-0198 Hong Kong 852-2720-5118 Taiwan Toll Free 0800-777-111 Neihu 886-2-2792-7818 Xindian 886-2-2218-4567 Taichung 886-4-2378-6250 Kaohsiung 886-7-229-3600	Asia Pacific Japan Toll Free 0800-500-1055 Tokyo 81-3-6802-1021 Osaka 81-6-6267-1887 Korea Toll Free 080-363-9494 Seoul 82-2-3663-9494 Singapore Singapore 65-6442-1000 Malaysia Toll Free 1800-88-1809 Kuala Lumpur 60-3-7725-4188 Penang 60-4-537-9188 Indonesia Jakarta 62-21-769-0525 Thailand Bangkok 66-2-248-3140 India Toll Free 1-800-425-5070 Pune 91-20-39482075 Bangalore 91-80-2545-0206 Australia Toll Free 1300-308-531 Melbourne 61-3-9797-0100 Sydney 61-2-9476-9300	Europe Toll Free 00800-2426-8080 Germany Munich 49-89-12599-0 Hilden / D'dorf 49-2103-97-885-0 France Paris 33-1-4119-4666 Italy Milano 39-02-9544-961 Benelux & Nordics Breda 31-76-5233-100 UK Reading 44-0118-929-4540 Poland Warsaw 48-22-33-23-740 / 41 Russia Toll Free 8-800-550-01-50 Moscow 7-495-232-1692	Americas North America Toll Free 1-888-576-9668 Cincinnati 1-513-742-8895 Milpitas 1-408-519-3898 Irvine 1-949-420-2500 Brazil Toll Free 0800-770-5355 Saude-São Paulo 55-11-5592-5355 Mexico Toll Free 1-800-467-2415 Mexico City 52-55-6275-2777
---	---	--	---

About This Manual

This user manual is intended to guide professional installers in installing and configuring the Serial Device Server. It includes technical specifications, software utility introduction, as well as procedures for the use of the software utility to self-manage the devices.

Contents

Chapter 1	Overview	1
1.1	Introduction	2
1.2	Device Features	2
1.3	Device Specifications	3
Chapter 2	Getting Started	5
2.1	Hardware Overview	6
2.1.1	Front View	6
2.1.2	Rear View	6
2.1.3	LED Indicators	8
2.1.4	Dimensions	10
2.2	Connecting Hardware	16
2.2.1	Rack Mount	16
2.2.2	Serial Connection	17
2.2.3	Power Connection	19
Chapter 3	Utility Configuration	23
3.1	Configuration Utility Overview	24
3.2	Installing the Configuration Utility	24
3.3	Menu Bar	27
3.4	Quick Tool Bar	28
3.4.1	Utility Settings	29
3.4.2	Discovering Your Device Server	31
3.4.3	Network Settings	33
3.5	Administrator Settings	36
3.5.1	Locate the Serial Device Server	36
3.5.2	Securing the Serial Device Server	37
3.5.3	Restore to Factory Default Settings	39
3.5.4	Resetting the Device	40
3.5.5	Add to Favorite	40
3.5.6	Auto Mapping	40
3.5.7	Manual Mapping	40
3.5.8	Update Firmware	41
Chapter 4	Selecting An Operating Mode	42
4.1	Overview	43
4.2	COM Port Redirector (Virtual COM Port)	43
4.2.1	Normal mode	44
4.2.2	Round-Robin mode	44
4.3	USDG Data Mode	45
4.3.1	USDG TCP Client Mode	45
4.3.2	USDG Data TCP Server mode	46
4.3.3	USDG UDP Server/Client mode	47
4.4	USDG Control mode	48
4.4.1	Hangup Character	48
4.4.2	Guard Time	48
4.5	RFC2217 Mode	49

Chapter 5 Setting Up Virtual COM Redirector . 50

5.1	Setting COM Redirector	51
5.2	Virtual COM Port Mapping	51
5.2.1	Auto Mapping	51
5.2.2	Manual Mapping	53
5.2.3	Configuration Wizard	54
5.2.4	Confirming Virtual COM Settings	55
5.2.5	Removing VCOM Ports	58
5.2.6	Exporting VCOM Mapping	58
5.2.7	Importing VCOM Mapping	59
5.3	Running a Diagnostic Test	59

Chapter 6 Web Configuration 60

6.1	Overview	61
6.2	Accessing the Web Page	61
6.2.1	Accessing the Web Page via Configuration Utility	61
6.2.2	Accessing the Web Page via Web Browser	62
6.3	System	62
6.4	Ethernet Configuration	63
6.5	Port Configuration	64
6.5.1	Basic	64
6.5.2	Operation	65
6.5.3	Advanced	67
6.6	Monitor	68
6.6.1	Setting	69
6.6.2	Statistic	70
6.6.3	Connected IP	71
6.7	Alert	72
6.7.1	Setting	72
6.7.2	Event	73
6.8	Syslogd	75
6.8.1	Syslogd Setting	75
6.8.2	Syslogd Message	76
6.9	Tools	77
6.9.1	Ping	77
6.9.2	Reboot	78
6.10	Management	78
6.10.1	Log File	78
6.10.2	Change Password	78
6.10.3	Secure access IP	79
6.10.4	Export Device Settings	79
6.10.5	Import Device Settings	80

Chapter 7 Telnet 81

7.1	Overview	82
7.2	Telnet Console	82
7.2.1	Create a new connection	82
7.2.2	Input the IP address	83
7.2.3	Connection Success	83
7.3	Serial Console	84
7.3.1	Connecting the cable	84
7.3.2	Select the COM port	84
7.3.3	COM Port Settings	85
7.3.4	Connection Success	86

7.4	Command List	86
7.4.1	system.....	86
7.4.2	port.....	87
7.4.3	portadv	87
7.4.4	mvcom	88
7.4.5	mctrl	88
7.4.6	mdata	88
7.4.7	net.....	89
7.4.8	password.....	89
7.4.9	alarm	89
7.4.10	monitor	90
7.4.11	time	90
7.4.12	service.....	90
7.4.13	mrhc2217	90
7.4.14	apply	90
7.4.15	exit	90
7.4.16	help	90
7.4.17	reboot.....	90

Chapter 8 TCP and UDP Port Numbers.....91

8.1	List of Known TCP and UDP Port Numbers.....	92
-----	---	----

List of Figures

Figure 2.1	Front View	6
Figure 2.2	Front View	6
Figure 2.3	Rear View	6
Figure 2.4	Rear View	7
Figure 2.5	Rear View	7
Figure 2.6	Rear View	7
Figure 2.7	Rear View	8
Figure 2.8	Rear View	8
Figure 2.9	System LED Panel	8
Figure 2.10	System LED Panel	9
Figure 2.11	EKI-1526/EKI-1526I Dimensions	10
Figure 2.12	EKI-1528/EKI-1528I Dimensions	11
Figure 2.13	EKI-1526T/EKI-1526TI Dimensions	12
Figure 2.14	EKI-1528T/EKI-1528TI Dimensions	13
Figure 2.15	EKI-1526N Dimensions	14
Figure 2.16	EKI-1528N Dimensions	15
Figure 2.17	Installing the Rack Mount Brackets	16
Figure 2.18	Installing the Switch	16
Figure 2.19	DB9 Pin Assignment	17
Figure 2.20	DB9 (male) to RJ45 cable	17
Figure 2.21	DB9 Pin Assignment	17
Figure 2.22	RJ45 Plug & RJ45 Connector Pin Assignment	18
Figure 2.23	RJ45 to DB9 Cable Assignment	18
Figure 2.24	Connecting AC Power	21
Figure 2.25	Connecting DC Power	21
Figure 3.1	InstallShield Wizard 1 of 4	24
Figure 3.2	InstallShield Wizard 2 of 4	25
Figure 3.3	InstallShield Wizard 3 of 4	25
Figure 3.4	InstallShield Wizard 4 of 4	26
Figure 3.5	Configuration Utility Overview	27
Figure 3.6	Quick Tool Bar Overview	28
Figure 3.7	View > Settings > Main Form Setting	29
Figure 3.8	View > Settings > Device Manager	30
Figure 3.9	Open View of Serial Device Configuration Utility	31
Figure 3.10	Selecting a Group	32
Figure 3.11	Selecting a Device	32
Figure 3.12	Viewing Basic Settings	33
Figure 3.13	Network Settings Overview	34
Figure 3.14	Reset Device	35
Figure 3.15	Locate the Serial Device Server	36
Figure 3.16	Lock the Serial Device Server	37
Figure 3.17	Enter a Password	37
Figure 3.18	Reset Device	38
Figure 3.19	Unlock the Serial Device Server	39
Figure 3.20	Change Password	40
Figure 3.21	Update Firmware	41
Figure 4.1	Virtual COM Mode	43
Figure 4.2	Configuring Virtual COM Mode	44
Figure 4.3	USDG TCP Client Mode	45
Figure 4.4	Peer for Receiving Data	46
Figure 4.5	USDG TCP Server Mode	46
Figure 4.6	USDG Data Mode	47
Figure 4.7	USDG Control Mode	48
Figure 5.1	Selecting Auto Mapping	51
Figure 5.2	Selecting Auto Mapping	52
Figure 5.3	Mapping Selected Ports	52

Figure 5.4	Viewing VCOM Mapping Results	52
Figure 5.5	Selecting Manual Mapping	53
Figure 5.6	Selecting Manual Mapping	53
Figure 5.7	Viewing Manual VCOM Mapping Results	54
Figure 5.8	Selecting the Configuration Wizard	54
Figure 5.9	Serial Port Listing on EKI Device	55
Figure 5.10	System Port VCOM Mapping Configuration	56
Figure 5.11	Verifying VCOM Mapping Configuration	56
Figure 5.12	Accessing the Web Page through the EKI Device Configuration Utility	58
Figure 6.1	Accessing the Web Page via Configuration Utility	61
Figure 6.2	System	62
Figure 6.3	Ethernet Configuration	63
Figure 6.4	Port Configuration > Basic.....	64
Figure 6.5	Port Configuration > Operation.....	65
Figure 6.6	Port Configuration > Advanced	67
Figure 6.7	Monitor > Setting	69
Figure 6.8	Monitor > Statistic.....	70
Figure 6.9	Monitor > Connected IP	71
Figure 6.10	Alarm > Setting.....	72
Figure 6.11	Alarm > Event.....	74
Figure 6.12	Syslogd > Syslogd Setting	75
Figure 6.13	Syslogd > Syslogd Message	76
Figure 6.14	Tools > Ping	77
Figure 6.15	Management > Log File	78
Figure 6.16	Management > Change Password.....	78
Figure 6.17	Management > Secure access IP	79
Figure 6.18	System	80
Figure 7.1	Creating a Telnet Connection.....	82
Figure 7.2	Creating a Telnet Connection.....	83
Figure 7.3	Telnet Connection Console	83
Figure 7.4	Creating a Serial Connection	84
Figure 7.5	Creating a Serial Connection	84
Figure 7.6	COM Port Settings	85
Figure 7.7	Connection success	86

Chapter 1

Overview

1.1 Introduction

This manual provides the necessary information to use the EKI-1526(TI) | 1528(TI). The Advantech EKI-1500 series of serial device servers consist of fast and cost-effective device servers between serial RS-232/422/485 and Ethernet interfaces.

The two Ethernet ports allow the EKI-1526(TI) | 1528(TI) to establish two separate Ethernet connections to two Ethernet domains or switches in the same domain. Through dual Ethernet connections, the EKI-1526(TI) | 1528(TI) greatly improve the device connectivity reliability, increases system stability, and simplifies redundant configuration.

By encapsulating serial data and transportation over Ethernet, the EKI-1526(TI) | 1528(TI) allow virtual serial links over Ethernet and IP (TCP/IP, UDP/IP) networks. After the Advantech Serial Device Server Configuration Utility (including COM port redirector driver) installation, standard serial operation calls are transparently redirected to the serial device servers, guaranteeing compatibility with legacy serial devices and enabling backward compatibility with existing software. The EKI-1526(TI) | 1528(TI) also support serial tunneling, allowing two native serial devices to communicate over a network without any hosts and programming. As a result, you can extend limited distance, point-to-point, direct serial connections within the plant, throughout the factory, the facility, the office building, or across the global enterprise.

The EKI-1526(TI) | 1528(TI) are industrial-grade network-based serial device servers for connecting up to 8 or 16 serial RS-232/422/485 devices, such as CNCs, PLCs, scales and scanners, directly to a TCP/IP network. The EKI-1526(TI) | 1528(TI) feature two independent Ethernet ports and MAC addresses to provide a redundant network mechanism to guarantee Ethernet network reliability. The EKI-1526(TI) | 1528(TI) provide a simple and cost-effective way to bring the advantages of remote management and data accessibility to thousand of devices that can't connect to an Ethernet network. The EKI-1526(TI) | 1528(TI) offer multiple ways to configure through the Windows utility, Web Browser, serial or Telnet console, these methods make it easy manage many EKI-1526(TI) | 1528(TI) or serial devices on your network.

1.2 Device Features

- 8 or 16-port RS-232/422/485 serial communication
- Provides 2 x 10/100/1000 Mbps Ethernet ports for LAN redundancy
- Support any baudrate from 50bps up to 921.6kbps
- Provides COM port redirection (Virtual COM), TCP and UDP operation modes
- Provides rich configuration methods: Windows utility, Telnet console, Web Browser, and serial console
- Built-in 15 KV ESD protection for all serial signals
- SNMP MIB-II for network management
- Built-in buzzer for easy location
- Standard 1U rackmount size
- Rear wiring
- Automatic RS-485 direction flow control

1.3 Device Specifications

Specifications	Description
Interface	I/O Ports <ul style="list-style-type: none"> ■ 2 x RJ45 ■ 8 or 16 x RS-232/422/485 See Ethernet and Serial Communications in this table for further information.
	Power Connector <ul style="list-style-type: none"> ■ 2-pin removable screw terminal (power & relay) ■ Power socket
Physical	Enclosure SECC chassis
	Installation Rack
	Dimensions (W x H x D) 438 x 43.6 x 259.2 mm (17.24" x 1.71" x 10.2")
LED Display	System LED Power, Status
	Port LED <ul style="list-style-type: none"> ■ LAN: Speed, Link/Active ■ Serial: Tx, Rx
Environment	Operating Temperature AC: 100 ~ 240 V _{AC} , 50 ~ 60 Hz, 0.16 A: 50°C (122°F) "I" models, 12 ~ 48 V _{DC} , 0.7A : 75°C (167°F)
	Storage Temperature -20°C ~ 80°C (-4°F ~ 176°F)
	Ambient Relative Humidity 10 ~ 95% (non-condensing)
Ethernet Communications	Compatibility IEEE 802.3, IEEE 802.3u, IEEE 802.3ab
	Speed 10/100/1000 Mbps, auto MDI/MDIX
	Port Connector 8-pin RJ45
	Ports 2 x RJ45
	Protection Built-in 1.5 KV magnetic isolation
Serial Communications	Port Type RS-232/422/485, software selectable
	Ports <ul style="list-style-type: none"> ■ EKI-1528/EKI-1528I/EKI-1528TI/EKI-1528N: 8 ■ EKI-1526/EKI-1526I/EKI-1526TI/EKI-1526N: 16
	Port Connector DB9 male
	Data Bits 5, 6, 7, 8
	Stop Bits 1, 1.5, 2
	Parity None, Odd, Even, Space, Mark
	Flow Control XON/XOFF, RTS/CTS, DTR/DSR
	Baud Rate 50 bps ~ 921.6 kbps, any baud rate setting 16 ports up to 230.4 kbps simultaneously
	Protection Built-in 15 KV ESD for all signals
Power	Power Consumption 5.6W
	Power Input <ul style="list-style-type: none"> ■ EKI-1528(I)/EKI-1526(I)/EKI-1526N/ EKI-1528N: 100 ~ 240 V_{AC}, 50 ~ 60 Hz, 0.16 A ■ EKI-1528T(I)/EKI-1526T(I): 12 ~ 48 V_{DC}, Terminal Block

Specifications	Description	
Software	Driver Support	32-bit/64-bit Windows 2000/XP/Vista/7/ 8/8.1/10, Windows Server 2003/2008/2012, and Linux
	Operation Modes	<ul style="list-style-type: none"> ■ COM port redirection mode (Virtual COM) ■ TCP/UDP server (polling) mode ■ TCP/UDP client (event handling) mode ■ Pair connection (peer to peer) mode ■ RFC2217 mode
	Configuration	Windows utility, Telnet console, Web Browser, serial console
	Management	SNMP MIB-II
Regulatory Approvals	EMC	CE, FCC Part 15 Subpart B (Class A)

Chapter 2

Getting Started

2.1 Hardware Overview

2.1.1 Front View

The following view shows the EKI-1526/EKI-1526I/EKI-1526T/EKI-1526TI/EKI-1526N.



Figure 2.1 Front View

No.	Item	Description
1	Reset button	Button allows for system soft reset (3 sec.).
2	Serial port	DB9 pinout, console port (female).
3	System LED panel	See "LED Indicators" on page 8 for further details.

The following view shows the EKI-1528/EKI-1528I/EKI-1528T/EKI-1528TI/EKI-1528N.



Figure 2.2 Front View

No.	Item	Description
1	Reset button	Button allows for system soft reset (3 sec.).
2	Serial port	DB9 pinout, console port (female).
3	System LED panel	See "LED Indicators" on page 8 for further details.

2.1.2 Rear View

The following view shows the EKI-1526/EKI-1526I.

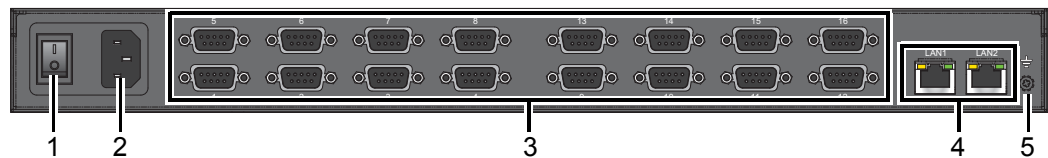

Figure 2.3 Rear View

No.	Item	Description
1	Power button	Turn the device on and off.
2	AC power in	Supports 100 ~ 240 VAC, 50 ~ 60 Hz.
3	Serial port	DB9 pinout, supports RS-232/422/485.
4	ETH port	RJ45 ports x 2
5	Ground terminal	Screw terminal used to ground chassis.

The following view shows the EKI-1526T/EKI-1526TI.

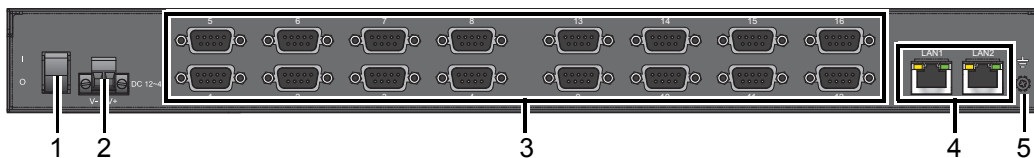

Figure 2.4 Rear View

No.	Item	Description
1	Power button	Turn the device on and off.
2	Terminal block	Connect cabling for power wiring.
3	Serial port	DB9 pinout, supports RS-232/422/485.
4	ETH port	RJ45 ports x 2
5	Ground terminal	Screw terminal used to ground chassis.

The following view shows the EKI-1526N.

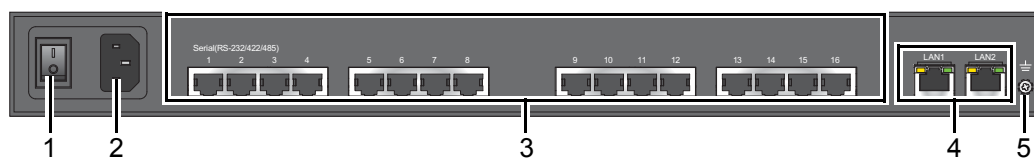

Figure 2.5 Rear View

No.	Item	Description
1	Power button	Turn the device on and off.
2	AC power in	Supports 100 ~ 240 VAC, 50 ~ 60 Hz.
3	Serial communication	RJ45 ports x 16
4	ETH port	RJ45 ports x 2
5	Ground terminal	Screw terminal used to ground chassis.

The following view shows the EKI-1528/EKI-1528I.

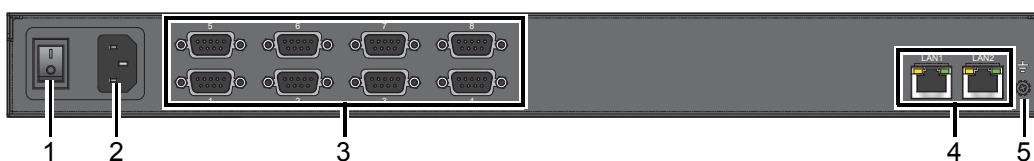

Figure 2.6 Rear View

No.	Item	Description
1	Power button	Turn the device on and off.
2	AC power in	Supports 100 ~ 240 VAC, 50 ~ 60 Hz.
3	Serial port	DB9 pinout, supports RS-232/422/485.
4	ETH port	RJ45 ports x 2
5	Ground terminal	Screw terminal used to ground chassis.

The following view shows the EKI-1528T/EKI-1528TI.

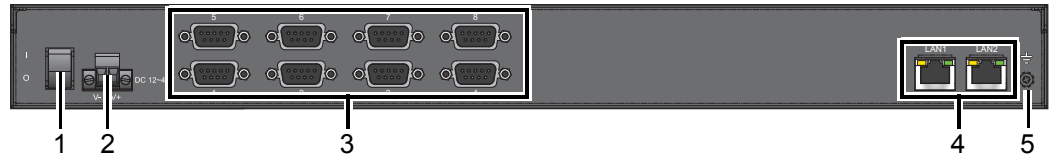

Figure 2.7 Rear View

No.	Item	Description
1	Power button	Turn the device on and off.
2	Terminal block	Connect cabling for power wiring.
3	Serial port	DB9 pinout, supports RS-232/422/485.
4	ETH port	RJ45 ports x 2
5	Ground terminal	Screw terminal used to ground chassis.

The following view shows the EKI-1528N.



Figure 2.8 Rear View

No.	Item	Description
1	Power button	Turn the device on and off.
2	AC power in	Supports 100 ~ 240 VAC, 50 ~ 60 Hz.
3	Serial communication	RJ45 ports x 8
4	ETH port	RJ45 ports x 2
5	Ground terminal	Screw terminal used to ground chassis.

2.1.3 LED Indicators

The following view shows the EKI-1526/EKI-1526I/EKI-1526T/EKI-1526TI/ EKI-1526N.

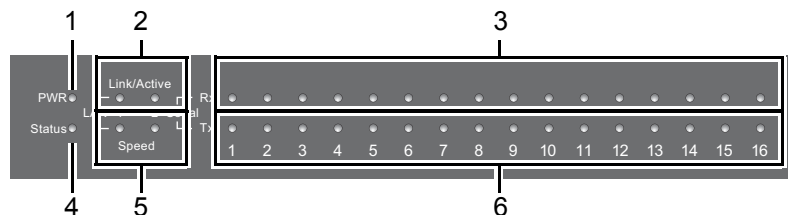

Figure 2.9 System LED Panel

No.	LED Name	LED Color	Status	Description
1	PWR	GREEN	ON	Power is on
			OFF	Power is off or power error condition exists
2	Link/Active	GREEN	ON	Valid network link
			OFF	Invalid network link

No.	LED Name	LED Color	Status	Description
3	RX	GREEN	ON	Data being received
			OFF	No data transmitted
4	Status	AMBER	ON	The device server has been located by utility's location function
			BLINKING	System is ready (1cycle/sec.)
			OFF	System is powered off
5	Speed	AMBER	ON	1000 Mbps speed
			OFF	10/100 Mbps speed
6	TX	AMBER	ON	Data being transmitted
			OFF	No data transmitted

The following view shows the EKI-1528/EKI-1528I/EKI-1528T/EKI-1528TI/EKI-1528N.

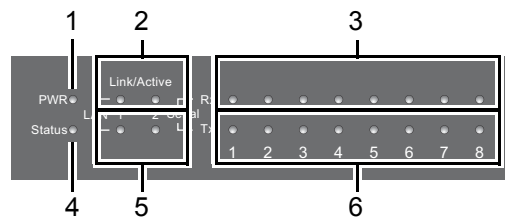

Figure 2.10 System LED Panel

No.	LED Name	LED Color	Status	Description
1	PWR	GREEN	ON	Power is on
			OFF	Power is off or power error condition exists
2	Link/Active	GREEN	ON	Valid network link
			OFF	Invalid network link
3	RX	GREEN	ON	Data being received
			OFF	No data transmitted
4	Status	AMBER	ON	The device server has been located by utility's location function
			BLINKING	System is ready (1cycle/sec.)
			OFF	System is powered off
5	Speed	AMBER	ON	1000 Mbps speed
			OFF	10/100 Mbps speed
6	TX	AMBER	ON	Data being transmitted
			OFF	No data transmitted

2.1.4 Dimensions

The following view shows the EKI-1526/EKI-1526I.

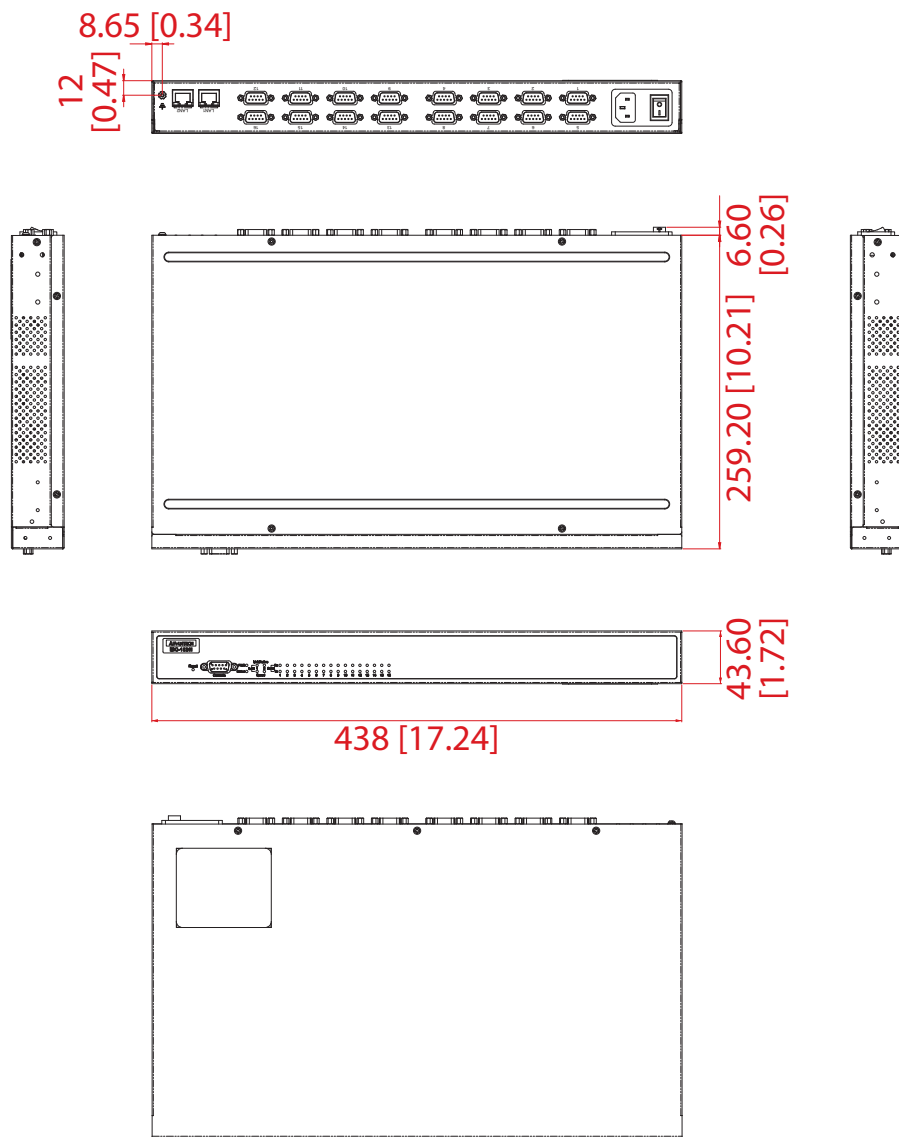

Figure 2.11 EKI-1526/EKI-1526I Dimensions

The following view shows the EKI-1528/EKI-1528I.

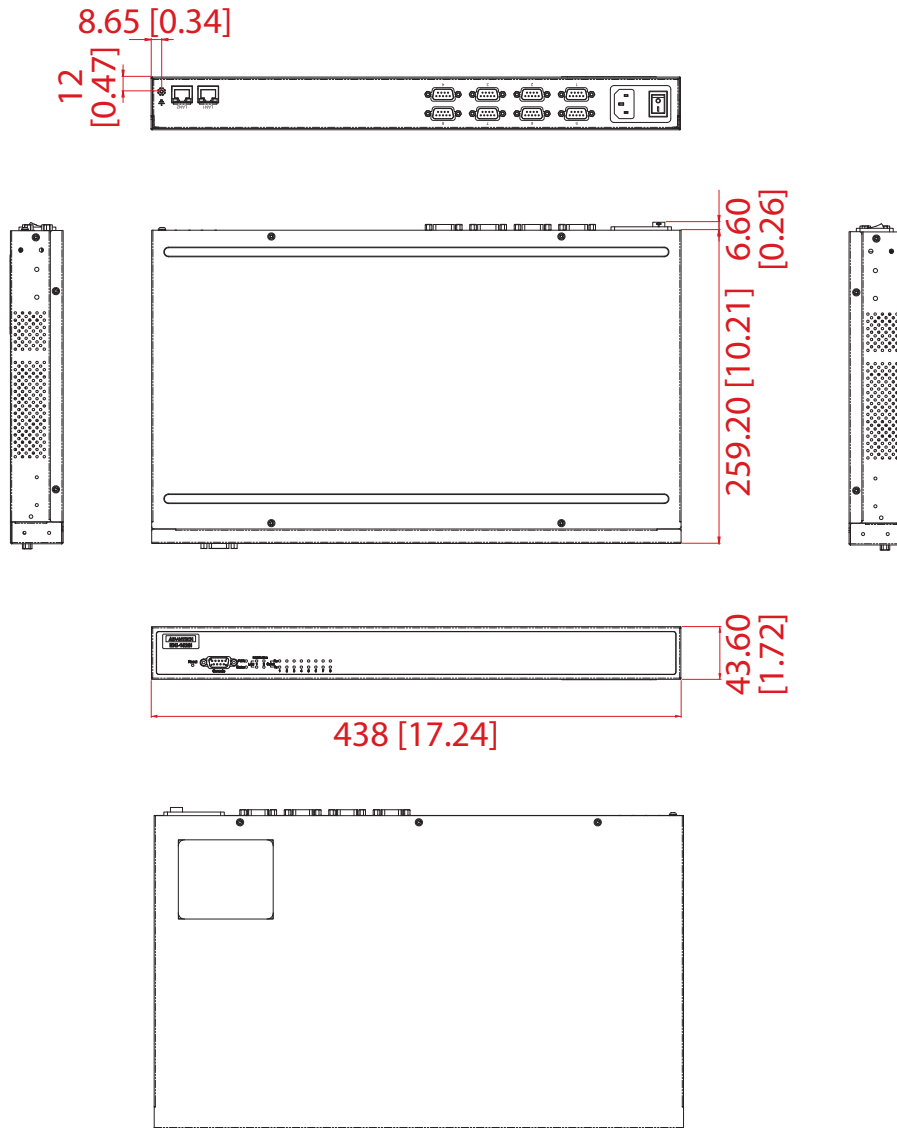

Figure 2.12 EKI-1528/EKI-1528I Dimensions

The following view shows the EKI-1526T/EKI-1526TI.

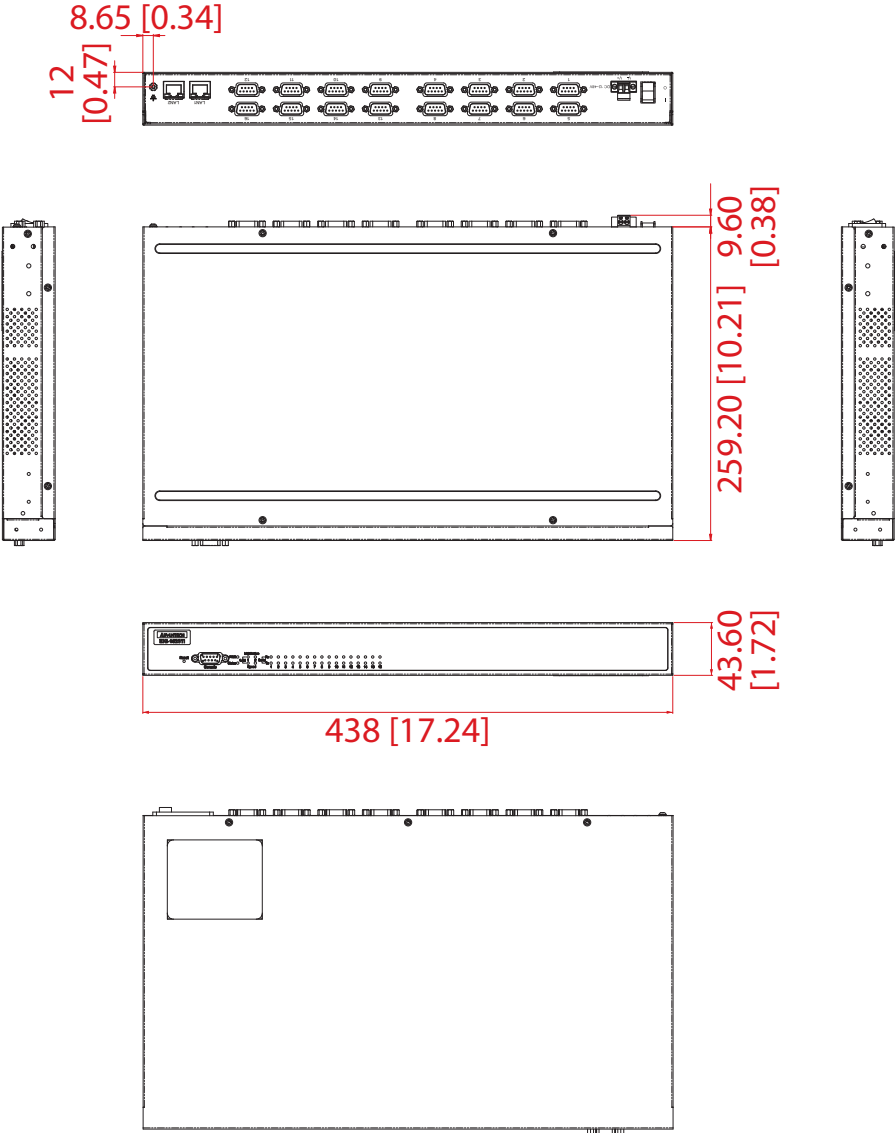

Figure 2.13 EKI-1526T/EKI-1526TI Dimensions

The following view shows the EKI-1528T/EKI-1528TI.

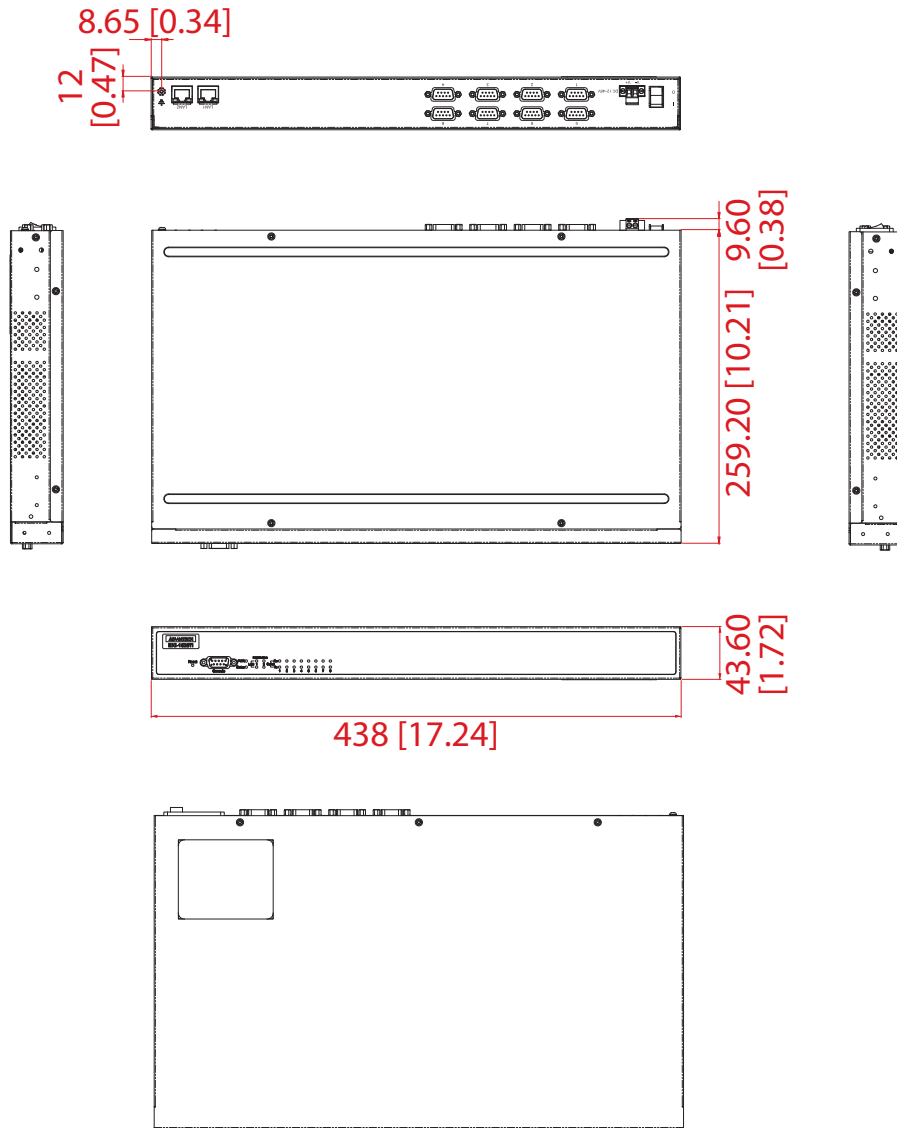

Figure 2.14 EKI-1528T/EKI-1528TI Dimensions

The following view shows the EKI-1526N.

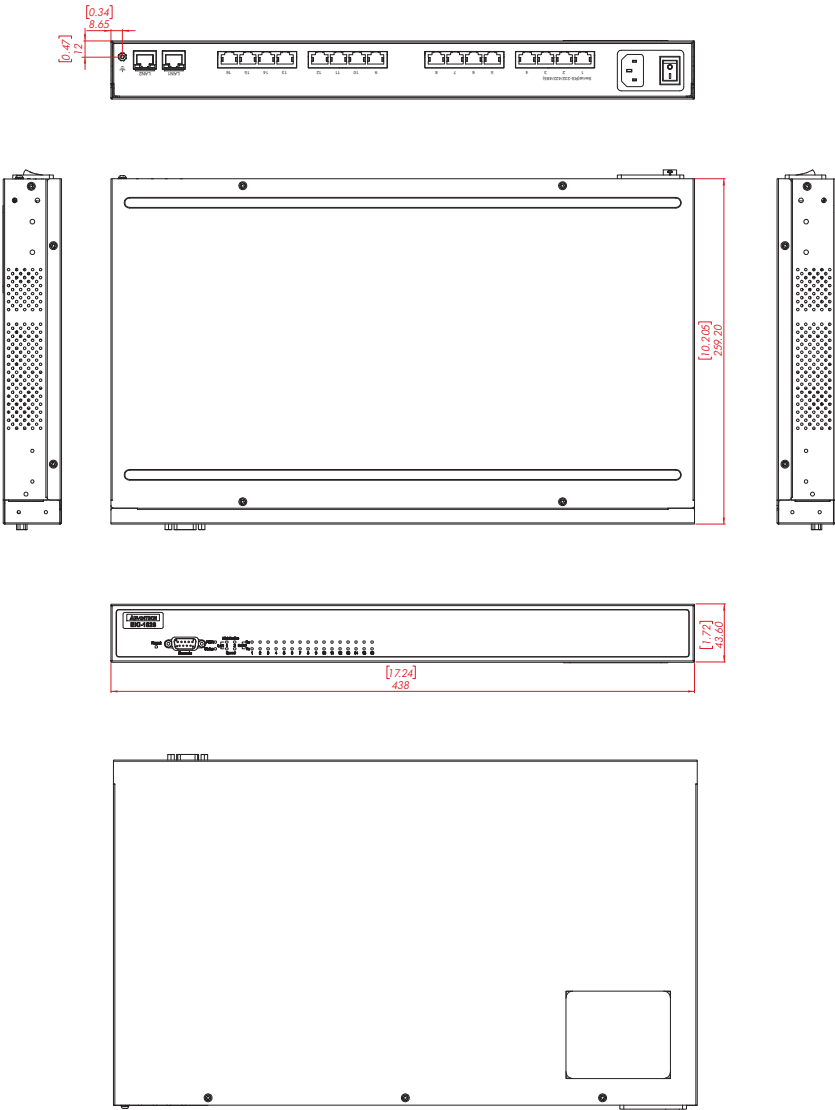

Figure 2.15 EKI-1526N Dimensions

The following view shows the EKI-1528N.

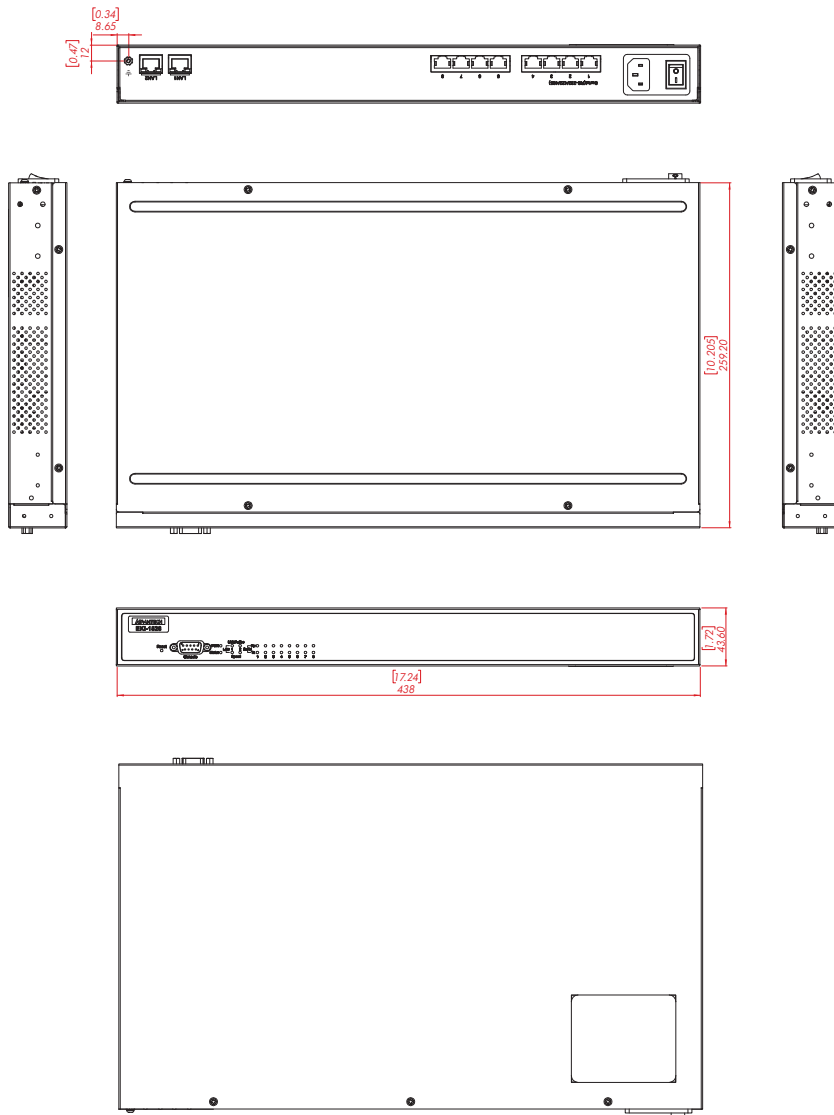

Figure 2.16 EKI-1528N Dimensions

2.2 Connecting Hardware



Devices in use may become hot to the touch. To prevent damage or injury, allow the device time to cool down before attempting to service it.

Les appareils utilisés pourraient devenir trop chauds au toucher. Pour éviter tout dommage ou blessure, attendez que l'appareil ait refroidi avant de tenter de l'entretenir.

2.2.1 Rack Mount

1. Align the rack mount brackets with the holes on the switch.
2. Secure the rack mount brackets with screws.

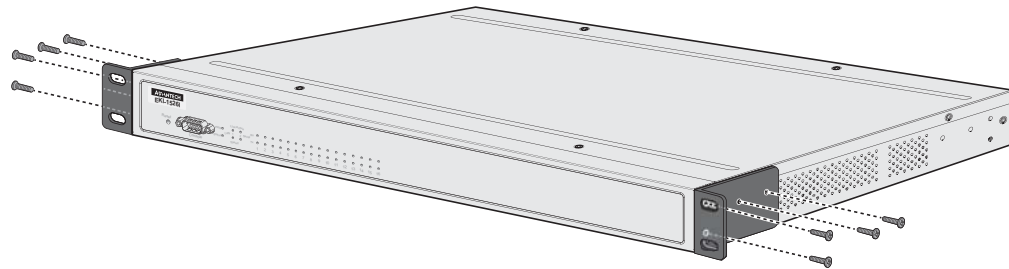

Figure 2.17 Installing the Rack Mount Brackets

3. Align the switch with the posts on the rack cabinet.
4. Secure the switch with screws.

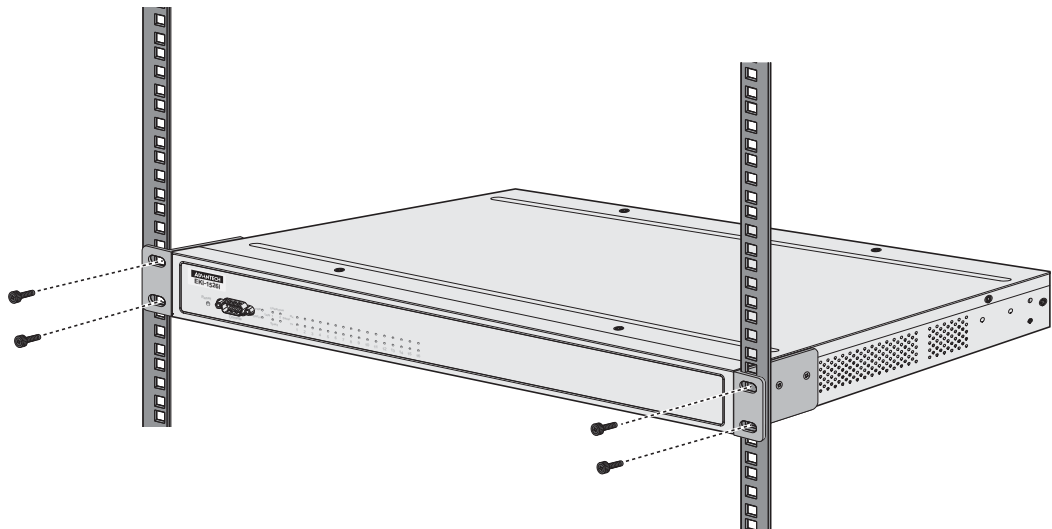

Figure 2.18 Installing the Switch

2.2.2 Serial Connection

EKI-1526(TI) | 1528(TI) Series provides 8/16 ports DB9 (male) connectors.

RS-232/422/485 pin assignments as below:

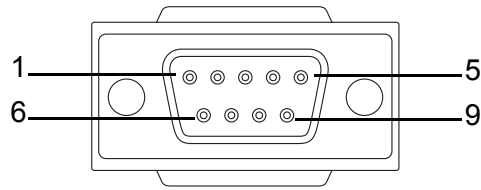

Figure 2.19 DB9 Pin Assignment

Pin	1	2	3	4	5	6	7	8	9
RS-232	DCD	RX	TX	DTR	GND	DSR	RTS	CTS	RI
RS-422	TX-			TX+	GND		RX+		RX-
RS-485	DATA-			DATA+	GND				

EKI-1526N | 1528N provides one DB9 (male) connector cable for serial communication.



Figure 2.20 DB9 (male) to RJ45 cable

The RS-232/422/485 pin assignments are shown below:

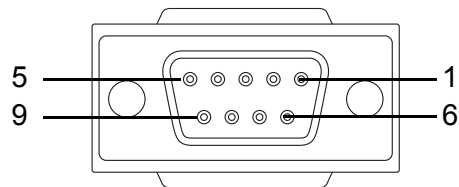

Figure 2.21 DB9 Pin Assignment

Pin	1	2	3	4	5	6	7	8	9
RS-232	DCD	RX	TX	DTR	GND	DSR	RTS	CTS	-
RS-422	TX-	TX+	RX+	RX-	GND				
RS-485	DATA-	DATA+			GND				

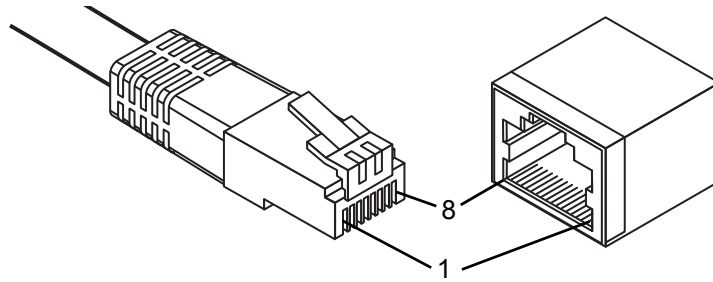

Figure 2.22 RJ45 Plug & RJ45 Connector Pin Assignment

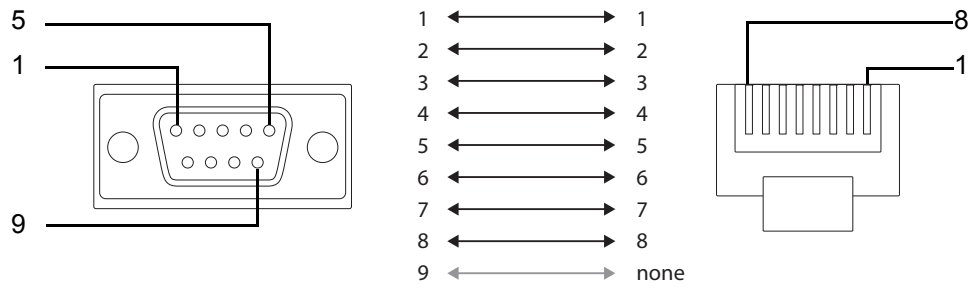

Figure 2.23 RJ45 to DB9 Cable Assignment

2.2.3 Power Connection

Warning! *Power down and disconnect the power cord before servicing or wiring the serial device server.*



Warning! *Do not disconnect modules or cabling unless the power is first switched off.*



The device only supports the voltage outlined in the type plate. Do not use any other power components except those specifically designated for the serial device server.

Warning! *Disconnect the power cord before installation or cable wiring.*



Warning! *Risk of explosion if the battery is removed and/or replaced by an incorrect type.*



Attention! *Risque d'explosion si la batterie est retirée et/ou remplacée par un type incorrect.*



Warning! *Risk of defeating the safeguard if the battery is removed or replaced by an incorrect type.*



Attention! *Risque de défaire la protection si la batterie est retirée ou remplacée par un type incorrect.*



Warning! *Risk of explosion if the battery is disposed in fire or hot environment or mechanically damaged--denting, crushing, and piercing the cell case.*



Attention! *Risque d'explosion si la batterie est disposée dans un environnement très exposé au feu ou un environnement chaud ou si elle est endommagée mécaniquement – y compris le bossellement, l'écrasement et la perforation du boîtier de pile.*



Warning! *Risk of explosion or leakage of flammable liquid or gas if the battery is left in an extremely high temperature environment.*



Attention! *Risque d'explosion ou de fuite de liquide ou de gaz inflammable si la batterie est laissée dans un environnement à température extrêmement élevée.*



Warning! *Dispose of used batteries in accordance with your local environmental regulations.*



Attention! *Jetez les batteries usagées conformément aux réglementations environnementales locales.*



Electrical current from power, telephone, and communication cables is hazardous.

To avoid a shock hazard:

- *Do not connect or disconnect any cables or perform installation, maintenance, or reconfiguration of this product during an electrical storm.*
- *Connect all power cords to a properly wired and grounded power source.*
- *Connect to properly wired power sources any equipment that will be attached to this product.*
- *When possible, use one hand only to connect or disconnect signal cables.*
- *Never turn on any equipment when there is evidence of fire, water, or structural damage.*
- *Disconnect the attached AC power cords, DC power sources, network connections, telecommunications systems, and serial cables before you open the device covers, unless you are instructed otherwise in the installation and configuration procedures.*
- *Connect and disconnect cables as described in the following table when you install, move, or open covers on this product or attached devices.*

The following is only available for EKI-1528/EKI-1528I/EKI-1528N/EKI-1526/
EKI-1526I/EKI-1526N.

Connect the EKI-1528/EKI-1528I/EKI-1528N or EKI-1526/1526I/EKI-1526N AC power line with its AC connector. If the power is properly supplied, you can turn on the power switch and the PWR LED will light green.

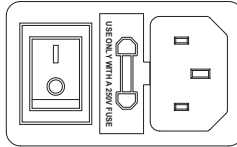

Figure 2.24 Connecting AC Power

The following is only available for EKI-1528T/EKI-1528TI/EKI-1526T/EKI-1526TI. Connect the DC power connector on the rear panel of the switch to the external power source with the included power cord, and check the power LED is on. The following figure illustrates the power socket location on the rear side of a EKI-1528T/EKI-1528TI or EKI-1526T/EKI-1526TI switch.

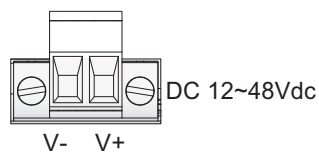

Figure 2.25 Connecting DC Power

Pour se connecter à une alimentation électrique:

1. Éteignez toutes les sources d'alimentation et tous les équipements connectés à l'appareil.
2. Fixez les câbles de signal au produit.
3. Fixez le cordon d'alimentation à l'appareil.
 - Pour les l'appareils à base de CA, assurez-vous de vous connecter aux prises d'appareil.
 - Pour les l'appareils à base de CC:
 - Assurez-vous que la polarité est comprise entre 12 et 48 VCC
 - RTN est une connexion positive
 - 12 à 48 VDC est une connexion négative
 - La mise à la terre doit être munie d'une cosse à deux trous pour la sécurité
4. Fixez les câbles de signal aux appareils connectés.
5. Connectez les cordons d'alimentation à la source.
6. Allumez toutes les sources d'alimentation.

Pour se déconnecter d'une alimentation électrique:

1. Éteignez toutes les sources d'alimentation et tous les équipements connectés à l'appareil.
 - Pour les l'appareils à base de CA: retirez tous les cordons d'alimentation de la prise d'alimentation du châssis ou interrompez l'alimentation du dispositif de distribution d'alimentation CA.
 - Pour les l'appareils à base de CC: débranchez les sources d'alimentation CC du panneau de disjoncteur ou éteignez la source d'alimentation avant de déconnecter les câbles CC.
2. Retirez les câbles de signal des connecteurs.
3. Retirez tous les câbles de l'appareil.

Chapter 3

Utility Configuration

3.1 Configuration Utility Overview

Advantech EKI series serial device servers provide an easy-to-use utility to configure your serial device server through an Ethernet connection. After the installation program on the Advantech EKI Device Configuration Utility CD-ROM is finished, the serial device servers are ready for use and configuration.

Advantech Serial Device Server Configuration Utility is an excellent device server management tool. You can connect and configure the local and remote Advantech serial device servers easily. The utility provides access to the following functions:

- Configure the network settings (you can set the IP address, Gateway address, and Subnet mask)
- View the serial port parameters
- Perform diagnostic tests (virtual COM port testing, port status list)
- Upgrade firmware

3.2 Installing the Configuration Utility

Note! Microsoft .NET Framework version 2.0 or greater is required for this application.



1. Insert the Advantech EKI Device Configuration Utility CD-ROM into the CD-ROM drive on the host PC.
2. Use Windows explorer or the Windows Run command to execute the setup program; the name of the setup program on the CD-ROM is "EKI Device Configuration Utility".
3. If there is an existing COM port mapping utility on the host PC, remove it at this time. A system reboot may be necessary before continuing the installation.
4. Once the InstallShield Wizard screen displays, click **Next** to proceed with the installation.

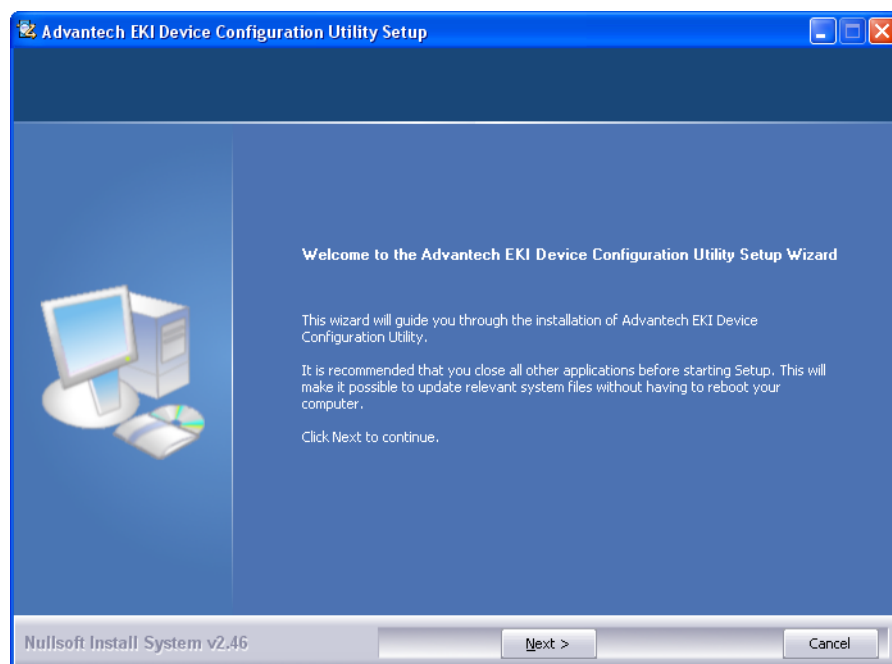

Figure 3.1 InstallShield Wizard 1 of 4

5. The Software License Agreement displays, press **I Agree** to continue or **Cancel** to stop the installation.

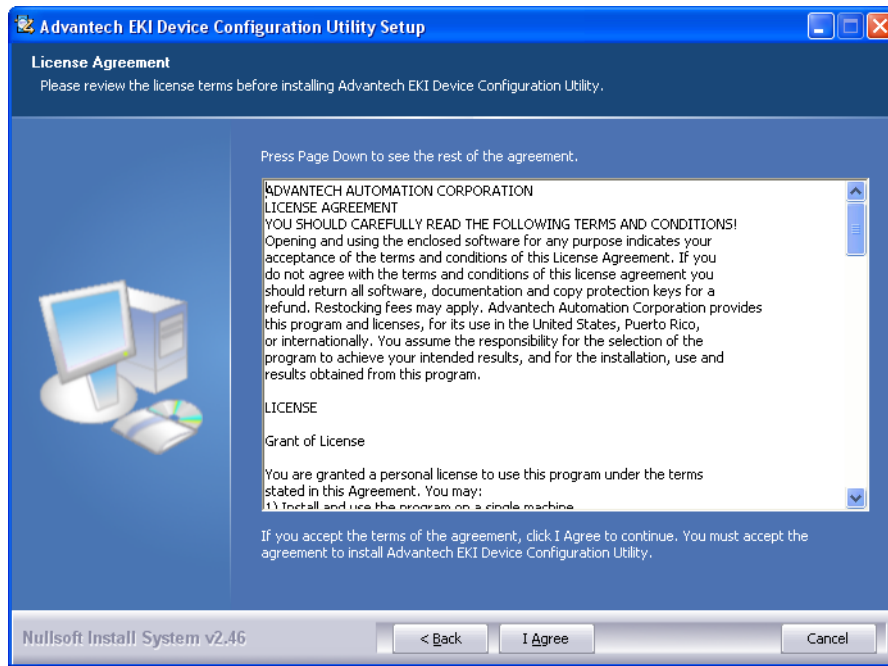

Figure 3.2 InstallShield Wizard 2 of 4

The InstallShield continues and a status screen displays. The default installation path is C:\Program Files\EKI Device Configuration Utility.

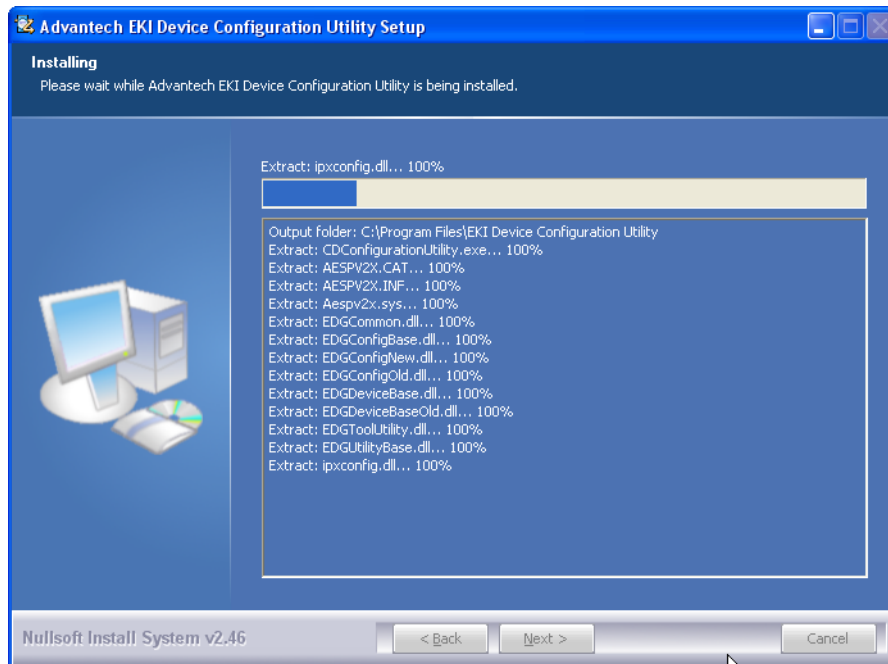

Figure 3.3 InstallShield Wizard 3 of 4

6. Once the installation of the package is finished a Configuration Utility Setup screen displays. Click **Finish** to conclude the process and exit the InstallShield Wizard.

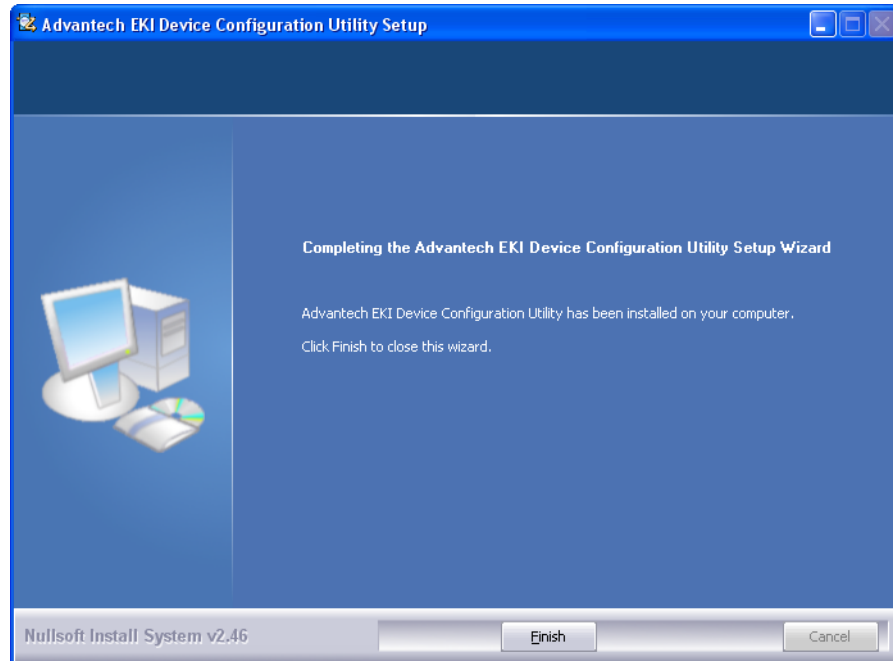

Figure 3.4 InstallShield Wizard 4 of 4

3.3 Menu Bar

You can open the Advantech EKI Device Configuration Utility from the Windows Start Menu by clicking **Start > All Programs > EKI Device Configuration Utility > Advantech EKI Device Configuration Utility**. The Configuration Utility displays as follows.

For the purposes of this manual, the user interface is separated into six sections.

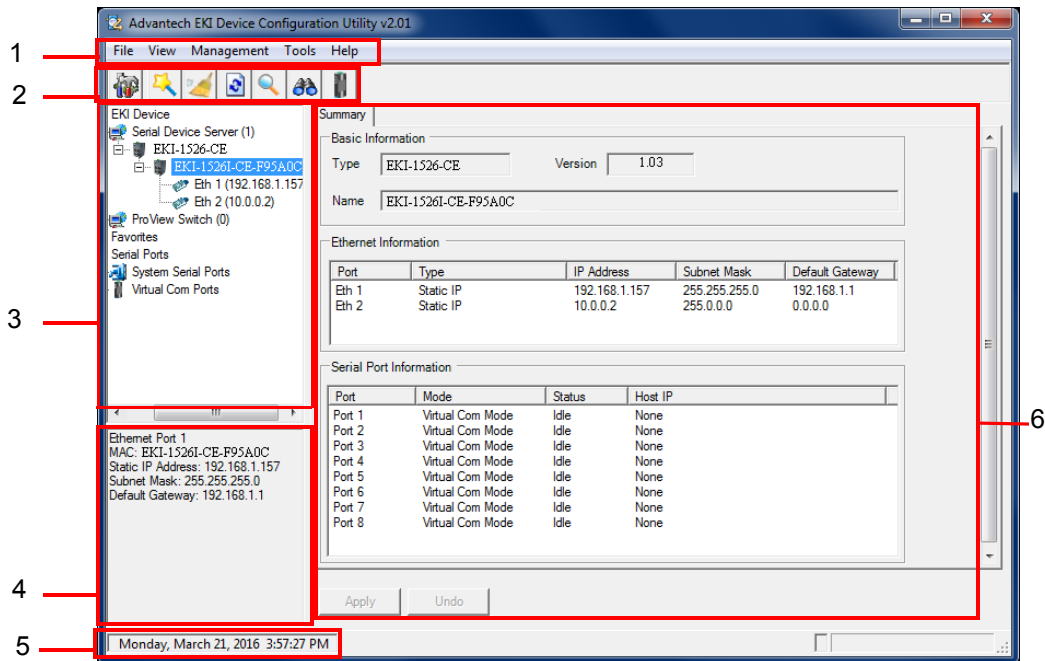

Figure 3.5 Configuration Utility Overview

No	Item	Description
1	Menu Bar	Displays File, View, Management, Tools and Help.
2	Quick Tool Bar	Useful management functions shortcuts.
3	Serial Device Server List Area	Available devices are listed in this area. Devices and COM ports can be organized or grouped in this area.
4	Information Panel	Click on the devices or move cursor to the devices, the related information is shown in this area.
5	Status Bar	Displays the current time.
6	Configuration Area	Click on the item on the Device Server List Area, the configuration page displays.

Note! *The configuration utility makes use of TCP/UDP ports 5048 and 5058 to communicate with the Advantech EKI serial device server.*



Please reserve TCP/UDP port 5048 and 5058 in your Ethernet network, configuration utility will use these ports to communicate with Advantech EKI-1000, ADAM-4570, and EDG-4500 serial device servers.

3.4 Quick Tool Bar

The Advantech EKI Device Configuration Utility makes use of a Quick Tool Bar menu to allow quick access to the management functions. See the following figure for further information.

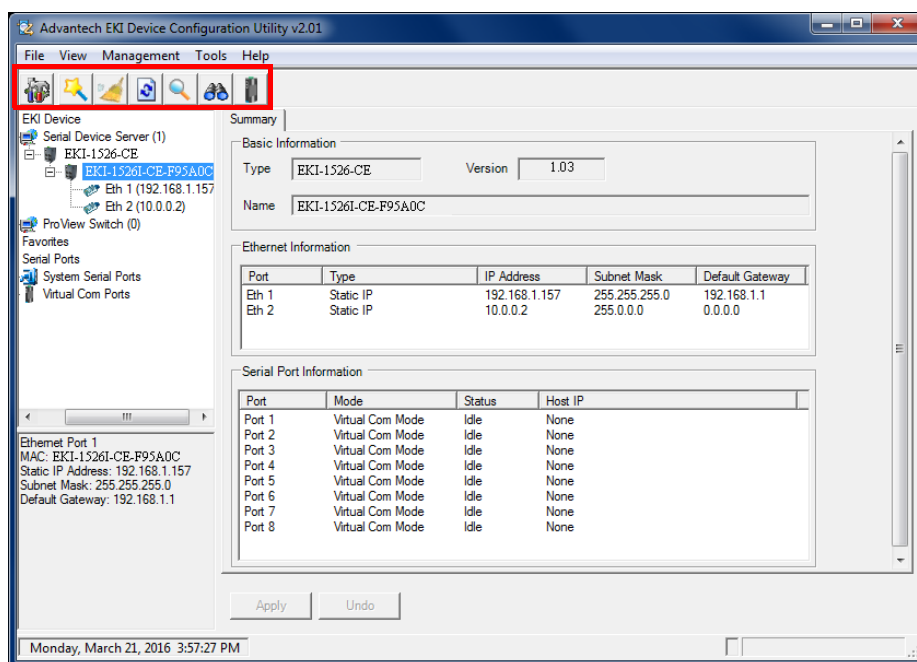









Figure 3.6 Quick Tool Bar Overview

Icon	Item	Description
	Utility Settings	Click to configure the general settings for the Main Form Setting and Device Manager menus. Refer to "Utility Settings" on page 29.
	Configuration Wizard	Start the software wizard (setup assistant) to lead you through the VCOM configuration process for device server product.
	Clear Device List and Search Again	Click to clear listed device servers in the Serial Device Server List Area and initiate a new search. <i>NOTE: A continuous click of the icon results in the following message: Please do not refresh so frequently.</i>
	Search Again	Click to search for serial device servers on the local LAN.
	Add IP Address to Favorite	Click to include the selected IP Address into the Favorites list group.
	Search for a Range of IP Addresses	Click to begin a range search. Enter the beginning and ending IP address to be a search within the string parameters.
	Manual Direct Mapping Virtual COM Port	Click to add a target by selecting the Device Type and inputting the IP address without physically connecting the serial device server to the network.

3.4.1 Utility Settings

3.4.1.1 Main Form Setting

Click **View** > **Settings** to configure utility settings.

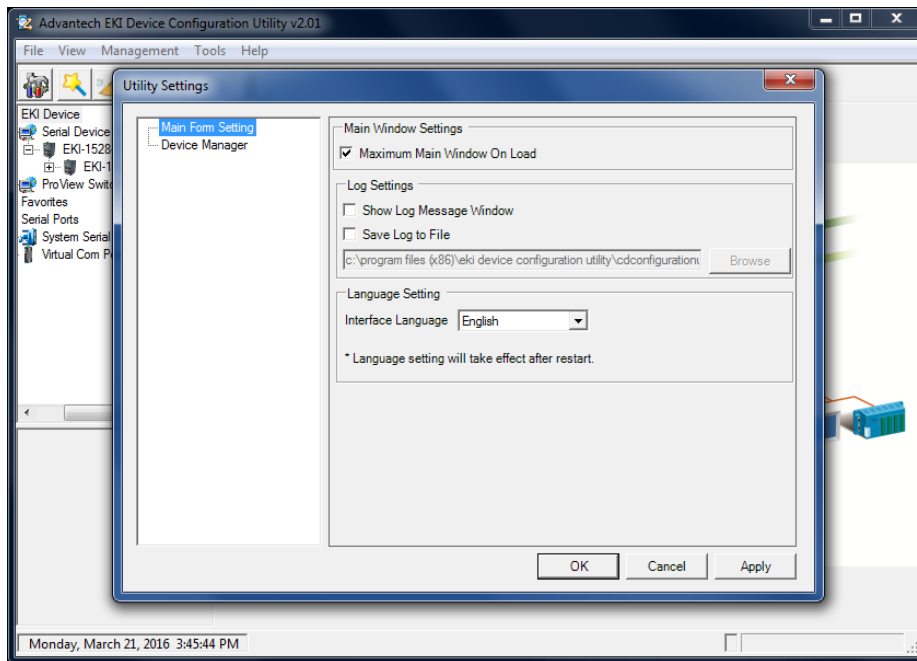

Figure 3.7 View > Settings > Main Form Setting

Item	Description
Main Window Settings	
Maximum Main Window On Load	Check the box to enable the limiting of main windows on-load to the maximum value.
Log Settings	
Show Log Message Window	Check the check box to activate the AdvLogMessage form. The Form Log message displays.
Save Log to File	Check the check box to save log to file.
Browse	If the Save Log to File option is enabled, click Browse to select a file to save log data.
Language Settings	
Interface Language	Click the drop-down menu to select an interface language: Traditional Chinese, Simplified Chinese or English. <i>NOTE: A restart is required for the settings to take effect.</i>
OK	Click OK to save and exit the Utility Settings menu.
Cancel	Click Cancel to discard the changes.
Apply	Click Apply to save the main form settings.

3.4.1.2 Device Manager

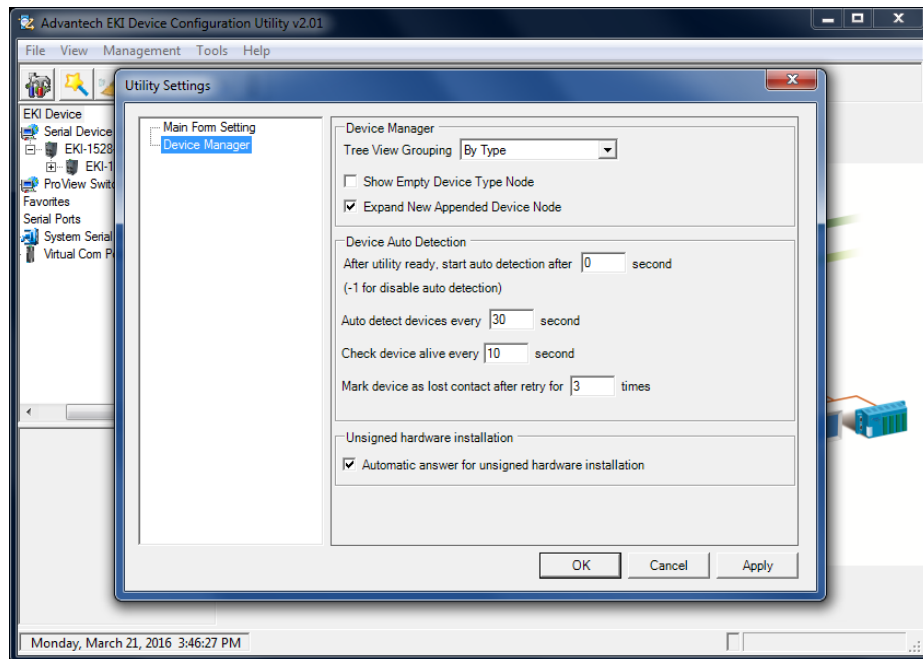

Figure 3.8 View > Settings > Device Manager

Item	Description
Device Manager	
Tree View Grouping	Click the drop-down menu to enable or disable grouping.
Show Empty Device Type Node	Check the check box to show empty device type node or not.
Expand New Appended Device Node	Check the check box to expand a new appended device node.
Device Auto Detection	
After utility ready, start auto detection after X second	Enter a value to specify the time to auto detection time (-1 means disable auto detection).
Auto detect devices every X second	Enter a value to specify the time to auto detect devices.
Check device alive every X second	Enter a value to specify the time to check device alive.
Mark device as lost contact after retry for X times	Enter a value to specify the time to mark device as lost contact.
Unsigned Hardware Installation	
Automatic answer for unsigned hardware installation	Check the check box to enable or disable answer automatically for unsigned hardware installation.
OK	Click OK to save and exit the utility setting.
Cancel	Click Cancel to discard the changes.
Apply	Click Apply to save the utility setting.

3.4.2 Discovering Your Device Server

3.4.2.1 Auto Searching

Advantech EKI Serial Device Server Configuration Utility 1.67 or higher will automatically search all the EKI-15xx series serial device servers on the network and show them on the Serial Device Server List Area of the utility. The utility provides an auto-search function to show your device (s) by simply executing the configuration utility program from the Start Menu.

From here all device on the same network domain will be searched and display on Device Server List Area. You can click on the device name to show the features of the specific device. Click on the “+” before the model name, and the utility will expand the tree structure to show the individual device name. Click on the “-” before the model name, and the utility will collapse the tree structure.

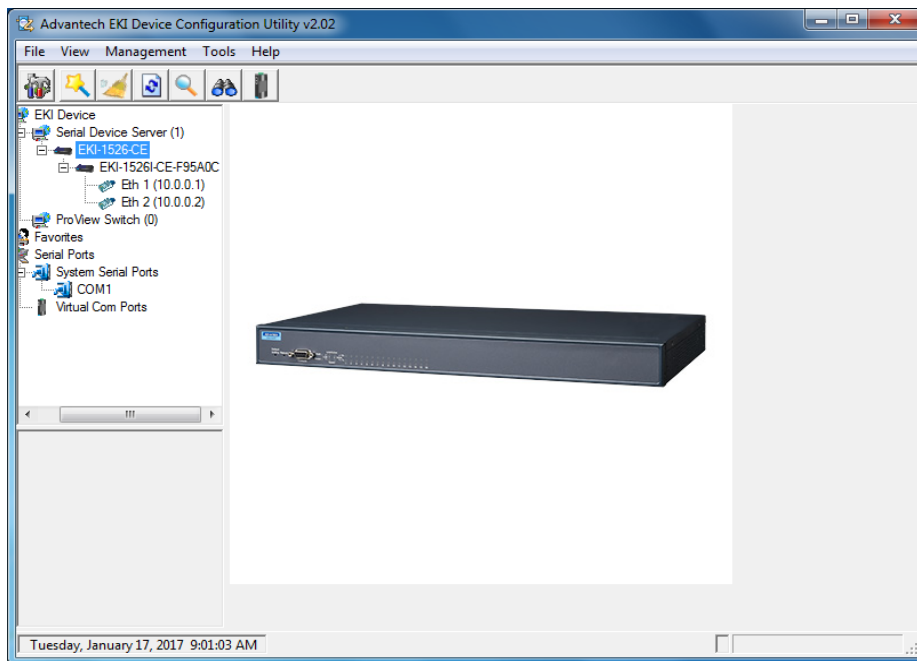

Figure 3.9 Open View of Serial Device Configuration Utility

In the previous figure, the EKI-1526I serial device server is listed as EKI-1526I-CE-F95A0C.

Note! *When you run the configuration utility for the first time, the default device name is obtained from the serial device’s MAC identification number. The name can be altered through the configuration utility.*



Select the device in this sub-tree. The Configuration Area shows a summary of “Basic Information”, including device type, version, and name, “Ethernet Information”, and “Serial Port Information”. The serial port information frame displays the operation mode, status and connected host IP.

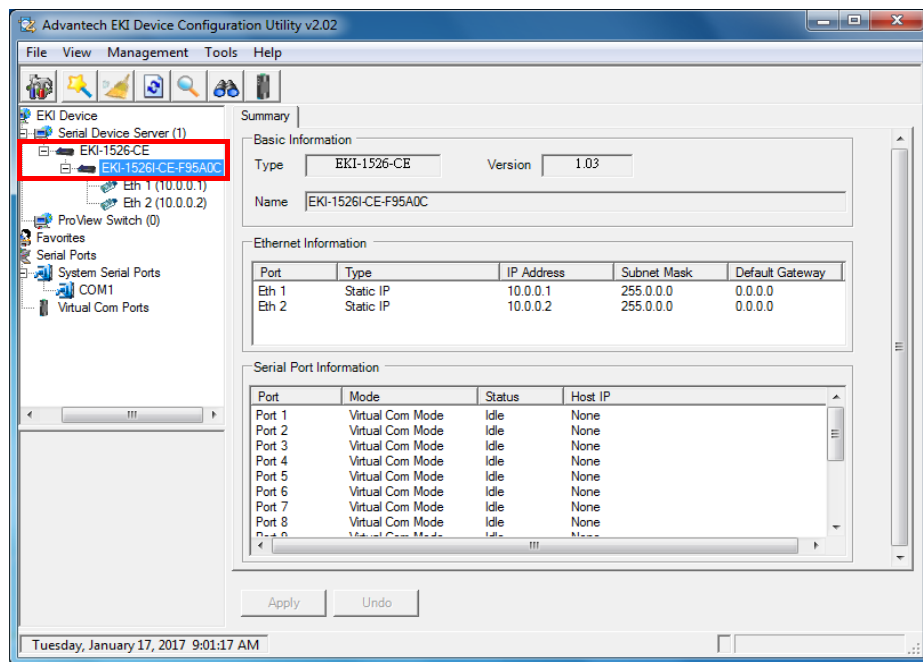

Figure 3.10 Selecting a Group

Click on the “+” before the device name, and the utility will expand the interfaces on this device server.

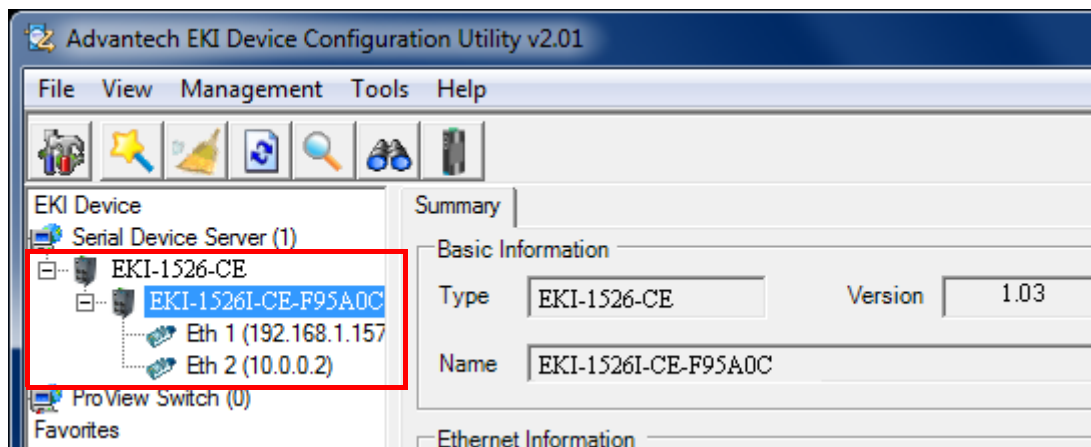

Figure 3.11 Selecting a Device

Click on each item to enter the configuration page to change the setting. The configuration will be introduced in the following sections.

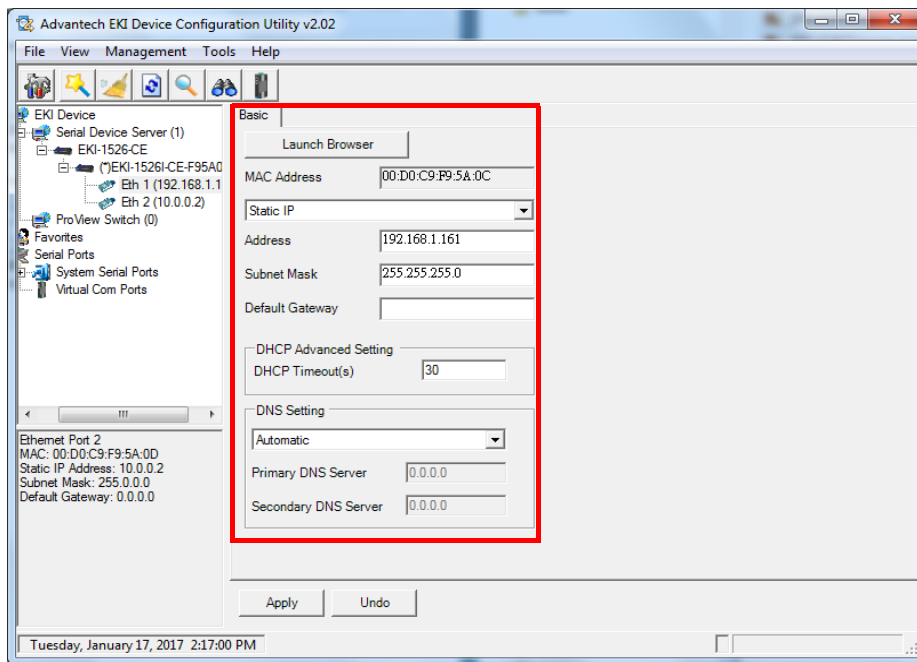

Figure 3.12 Viewing Basic Settings

3.4.3 Network Settings

Prior to setting up the server's IP address, determine the IP address mode.

There are four mode types available:

- Static IP: mode to assign a specific assigned address
- DHCP / AutoIP: mode to automatically assign IP addresses through a DHCP server
- BOOTP / AutoIP: mode to automatically assign an IP address through the configuration server
- DHCP/BOOTP/AutoIP: mode to automatically assign an IP address using a Bootstrap Protocol or DHCP server.

The server is set with the following default IP configuration:

10.0.0.1 (Eth1)

10.0.0.2 (Eth2)

The EKI series includes a software utility option, which you can install on your system, for configuration through computer-based software. The EKI series also includes a web interface option for configuration through a standard web browser. You can choose from four possible IP Configuration modes --- Static, DHCP, BOOTP, and DHCP/BOOTP.

Figure 3.13 Network Settings Overview

Item	Description
Static IP	Static IP User defined IP address, Subnet Mask, and Default Gateway.
DHCP + Auto-IP	DHCP Server assigned IP address, Subnet Mask, Default Gateway, and DNS.
BOOTP + Auto-IP	BOOTP Server assigned IP address.
DHCP + BOOTP + Auto-IP	DHCP Server assigned IP address, Subnet Mask, Default Gateway, and DNS, or BOOTP Server assigned IP address. (If the DHCP Server does not respond)
DNS Setting	In order to use DNS feature, you need to set the IP address of the DNS server to be able to access the host with the domain name. The EKI serial device server provides Primary DNS Server and Secondary DNS Server configuration items to set the IP address of the DNS server. Secondary DNS Server is included for use when Primary DNS server is unavailable.
DHCP Advanced Setting	When you enabling DHCP protocol to get IP address, it will be waited DHCP server to give IP within DHCP time out. The default value is 180 seconds.

Note!  When you have finished the configuration of these settings for each category, please press the “Apply” button in order to make these settings effective on the Serial Device Server.

Click **Reboot** to reboot the serial device server. Any configuration changes you have made since the last time you saved will be lost.

To reset the device:

1. Right-click a desired device to display the settings menu.
2. Select **Reset Device**.

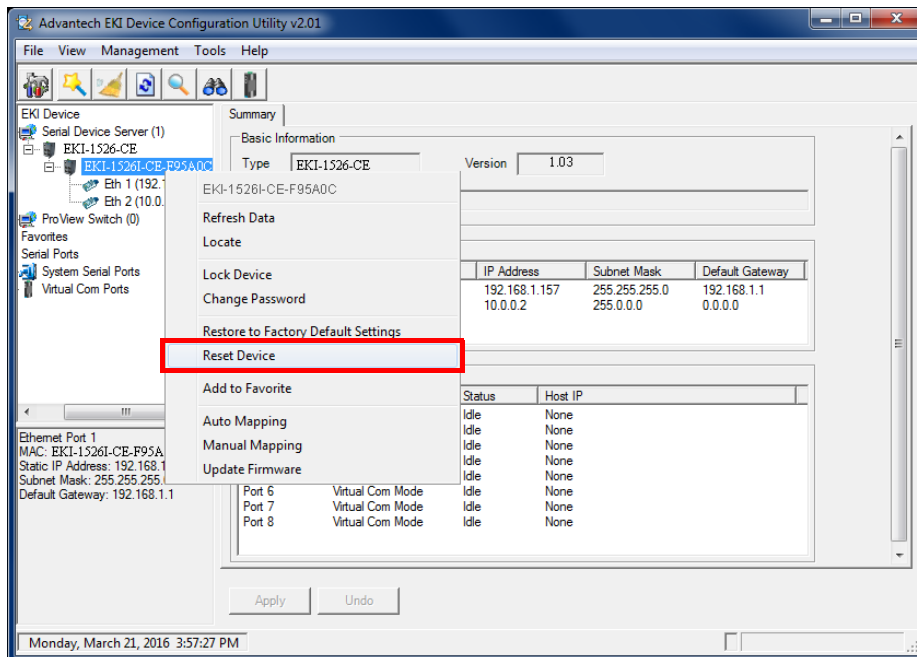

Figure 3.14 Reset Device

3.5 Administrator Settings

3.5.1 Locate the Serial Device Server

When several serial device servers are connected to the network, identification of a specific serial device is possible through the Locate function.

To locate the serial device server:

1. From the device list frame, locate the desired device and right-click on it to display the settings menu.
2. Select **Locate** from the menu.

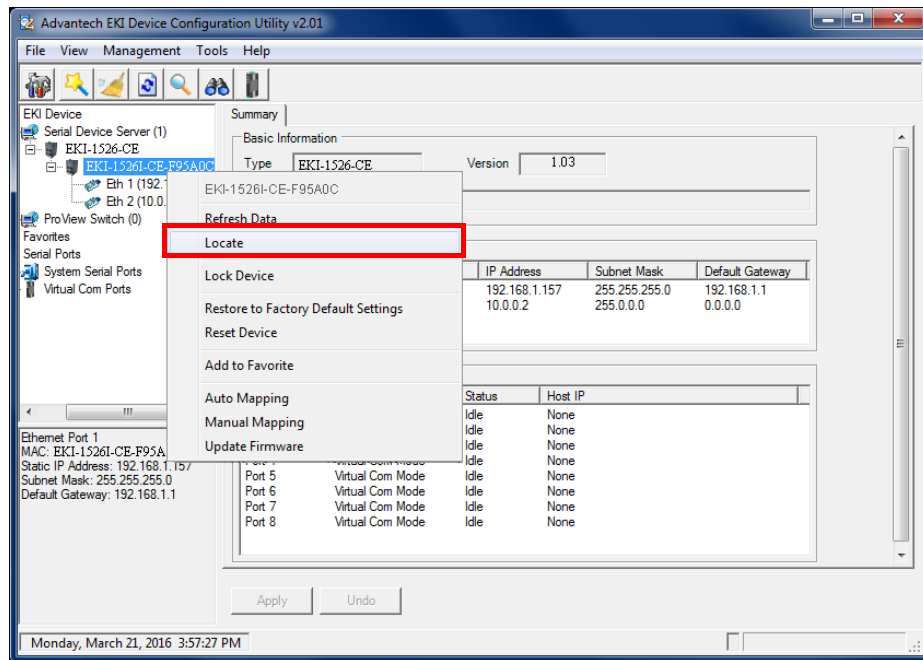

Figure 3.15 Locate the Serial Device Server

The unit's Status LED will turn solid amber, and the buzzer will make a beep sound until you click **Stop Locate**.

3.5.2 Securing the Serial Device Server

3.5.2.1 Lock the Serial Device Server

The configuration utility provides a “Lock Device” function to make it more secure.

To lock the serial device server:

1. Right-click a desired device to display the settings menu.
2. Select **Lock Device**.

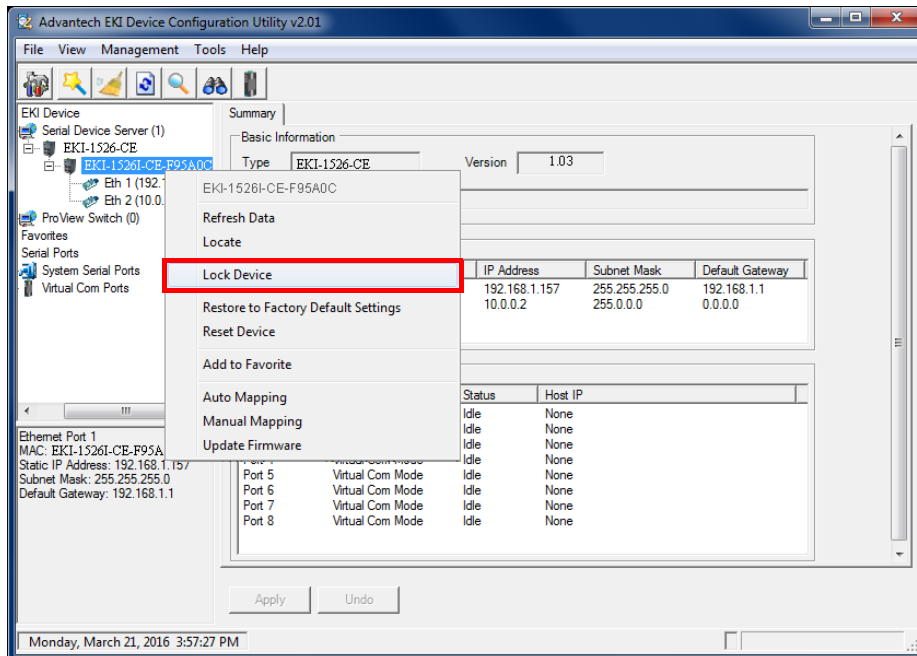

Figure 3.16 Lock the Serial Device Server

3. Enter a password. Retype the password entry to confirm the profile password.

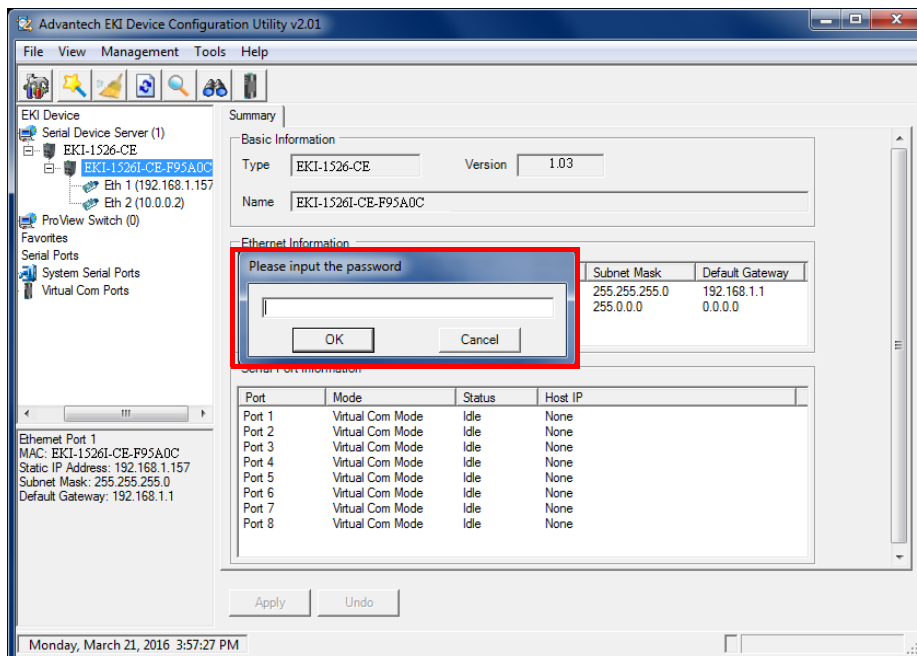

Figure 3.17 Enter a Password

4. Right-click a desired device to display the settings menu. Select **Reset Device** to restart the serial device server and store your setting password into the memory.

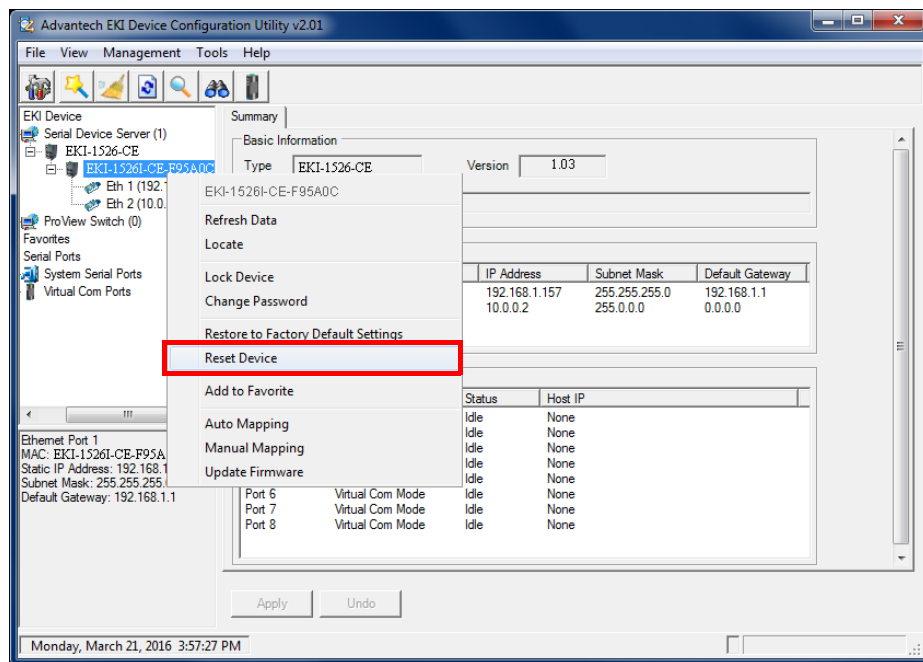

Figure 3.18 Reset Device

3.5.2.2 Unlock the Serial Device Server

To unlock the serial device server:

1. Right-click a desired device to display the settings menu.
2. Select **Unlock Device**.

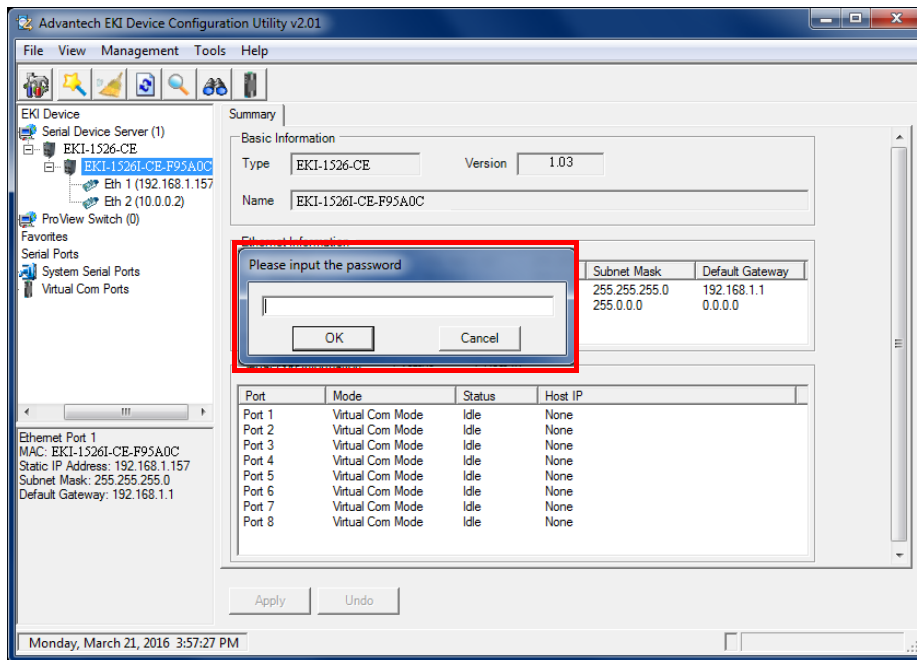

Figure 3.19 Unlock the Serial Device Server

3. Enter the password as entered in the Lock Device procedure.
If you forgot the password, you must restore the setting of the serial device server to the factory defaults, which will be introduced in the next section.

3.5.3 Restore to Factory Default Settings

The configuration utility provides the function to restore the serial device server to factory default settings. The confirm message will display after clicking **Restore to Factory Default Settings**. If you really want to restore the serial device server to factory default settings, please click "Yes" button to continue.

Power off the serial device server within ten seconds. After reconnecting the power, all settings will be reset to the factory default. If the power supply remains connected for more than ten seconds, the serial device server will not be changed.

3.5.4 Resetting the Device

The Reset Device allows you to reset the serial device server. The function disconnects both the ethernet and serial connections.

To reset the device:

1. Right-click a desired device to display the settings menu.
2. Select **Reset Device**.

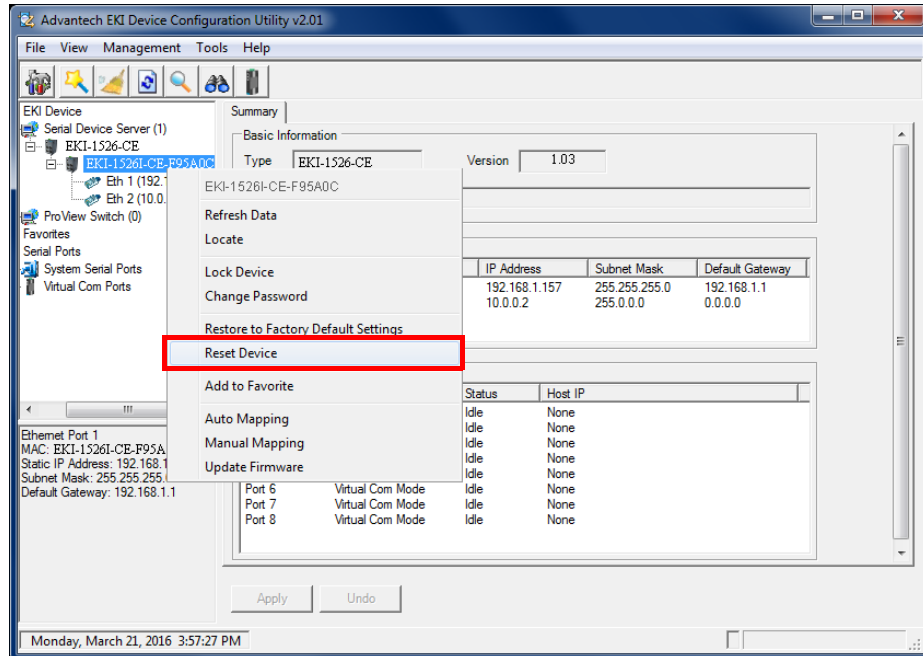

Figure 3.20 Change Password

The device resets. Once the process is complete, the serial device server displays under the Serial Device Server listing once again.

3.5.5 Add to Favorite

The Add to Favorite function allows to easily map available devices to Favorite's. By bookmarking specific devices, you can create quickly accessible shortcuts for existing critical devices from the vast pool of locally or remotely networked EKI devices.

3.5.6 Auto Mapping

See "Auto Mapping" on page 51 for further details.

3.5.7 Manual Mapping

See "Manual Mapping" on page 53 for further details.

3.5.8 Update Firmware

Advantech continually upgrades its firmware to keep up with the ever-expanding world of computing. You can use the update firmware function in the utility to carry out the upgrade procedure. Please access Advantech's website: <http://www.advantech.com> to download the latest version of the firmware. Before updating the firmware, make sure that your host's network domain is as same as the serial device server or the host can establish the TCP connection to the serial device server.

To update firmware:

1. Right-click a desired device to display the settings menu.
2. Select **Update Firmware**.

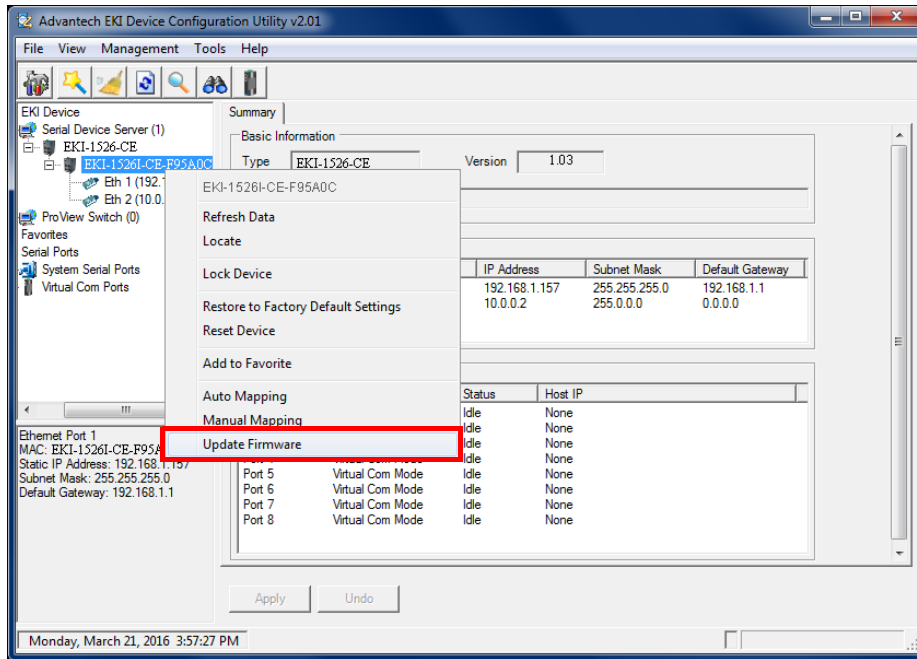

Figure 3.21 Update Firmware

3. Select the firmware file you want to update.

Wait for a few seconds for the firmware to finish updating. After the update has completed, click on the **OK** button.

Note! *Be sure that the host PC Ethernet network domain is as same as the EKI-1500 Series serial device server or the host PC can establish the TCP connection with the serial device server during the updating firmware process.*



Chapter 4

Selecting An
Operating Mode

4.1 Overview

The EKI-1526(TI) | 1528(TI) are designed to network-enable any RS-232/422/485 serial device, and provides industry-grade hardware and easy-to-use software to make connecting serial devices to an Ethernet network a surprisingly simple process. These units immediately upgrade your existing serial devices for integration into the Internet world. The EKI-1526(TI) | 1528(TI) feature many powerful functions, such as high speed data transfer, access-control, auto-detection of all EKI series products, and more.

After the simple installation steps to attach your network and serial device to the appropriate connectors on the serial device servers and driver installation, you will be able to communicate with the serial devices via its own application software and with the EKI serial device server. COM port redirector, USDG TCP server mode, TCP client mode, UDP server mode, UDP client mode, RFC2217 mode are all different methods of making a serial connection across using one or more serial device servers.

4.2 COM Port Redirector (Virtual COM Port)

Advantech EKI Device Configuration Utility is a serial COM port redirector that creates virtual COM ports and provides access to serial device connected to Advantech serial device server. You can configure the serial device server and enable the Virtual COM port using one integrated utility. Advantech EKI Device Configuration Utility allows you to configure Microsoft applications to communicate with network enabled serial device servers as easily as if they were physically installed in or directly connected on the PC.

The Advantech redirector can create up to 255 virtual COM ports. Application on the host can open virtual COM port to access the serial device servers at the same time. The redirector will handle each active virtual COM port as a separate TCP connection to Advantech serial device servers.

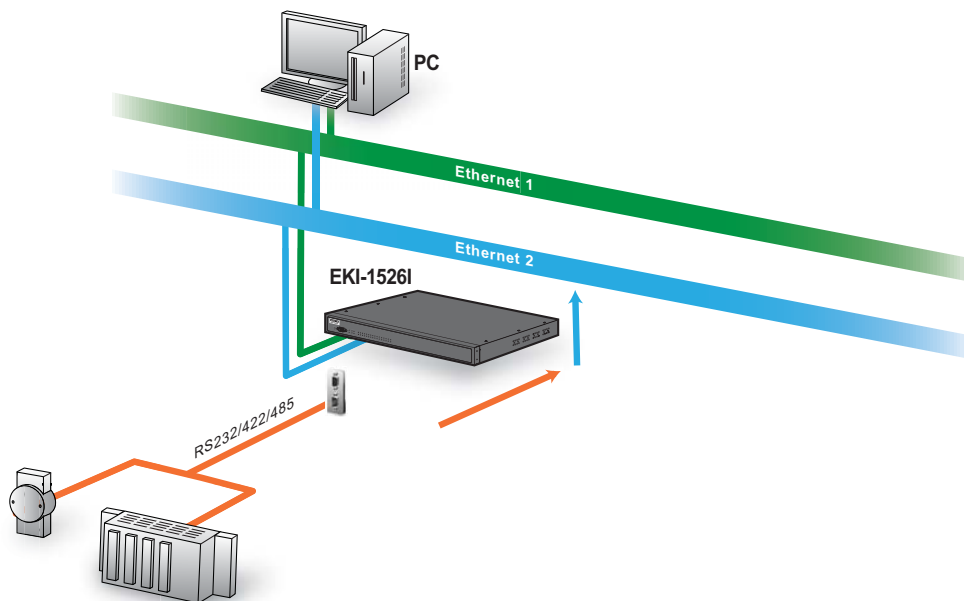
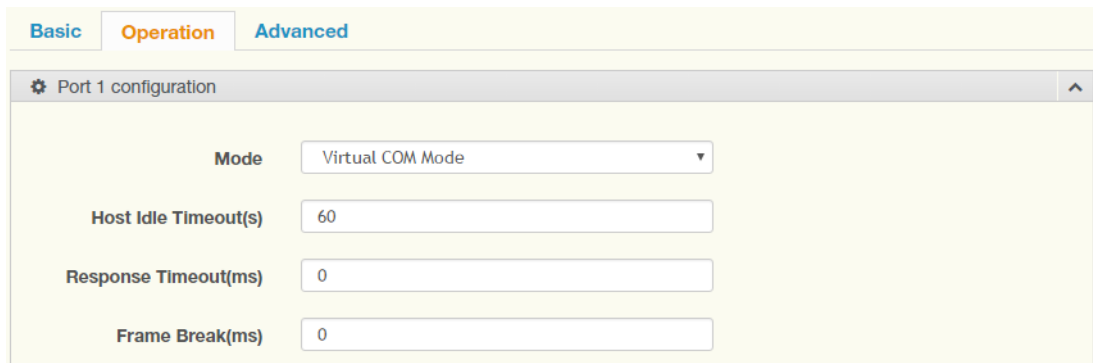

Figure 4.1 Virtual COM Mode

The EKI-1526(TI) | 1528(TI) provide Multi-access function through an Ethernet connection path, allowing a maximum of five connections to open one serial port simultaneously. In this mode, all connections use the same serial setting. If one serial setting within this configuration is configured differently, the data communication will not function correctly.



The screenshot shows a web-based configuration interface for 'Port 1 configuration'. It has three tabs: 'Basic', 'Operation', and 'Advanced'. The 'Operation' tab is selected. Underneath, there are four configuration items:

- Mode:** A dropdown menu set to 'Virtual COM Mode'.
- Host Idle Timeout(s):** A text input field containing the value '60'.
- Response Timeout(ms):** A text input field containing the value '0'.
- Frame Break(ms):** A text input field containing the value '0'.

Figure 4.2 Configuring Virtual COM Mode

The Host Idle Timeout setting monitors the connection between the host and the device. If the Host Idle Timeout setting time is reached, the device server will release the resources allocated to the port mapping. This prevents a stalled host from affecting the connective device.

The Multi-access function has two modes. One is **Normal mode** and the other is **Round-Robin mode**.

4.2.1 Normal mode

By disabling the Response Timeout parameter, the EKI-1526(TI) | 1528(TI) Series will operate in normal mode. When multiple hosts simultaneously open the serial port, only the first connected host has management control; the remaining connections only have a data communication function. Each serial port supports up to five simultaneous connections, so multiple hosts can transmit/receive data to/from the same serial port simultaneously. Every host can transmit data to the same serial port, and the EKI-1526(TI) | 1528(TI) Series will also transmit data to every hosts. When the multiple hosts transmit data to the same serial port at the same time, the received data from Ethernet and the outputs of serial port are mixed. When the EKI-1526(TI) | 1528(TI) Series receives data from serial port, the data will also be transmitted to the connected hosts simultaneously.

4.2.2 Round-Robin mode

By enabling the **Response Timeout** parameter, the EKI-1526(TI) | 1528(TI) Series operates in “Round-Robin mode”. Each serial port supports up to five simultaneous connections allowing hosts to simultaneously transmit/receive data to/from the same serial port. Every host can simultaneously transmit data to the same serial port, EKI-1526(TI) | 1528(TI) Series processes the data in the order arrived. The EKI-1526(TI) | 1528(TI) Series processes the first host’s request and replies. The serial device server determines the end of the serial acknowledgement through a response timeout. When EKI-1526(TI) | 1528(TI) serial device server does not receive a response from the serial port after a response timeout query, the device replies with an acknowledgement and then processes the next host request.

With an increased number of hosts, response time may be lengthy, increasing the period of the Response Timeout. **Frame Break** is therefore an important parameter for Round Robin mode. The parameter is a smart method of reducing ineffective waiting periods and streamlining the transmission process.

By disabling the Frame Break function, the series devices will wait for a “Response Timeout” period, whether or not the device has transmitted data. During this period, the host commands are queued and processed in the order received.

If Frame Break is enabled, the serial port idle is longer than the Frame Break period. The EKI-1528 Series assumes the communication is completed and continues with the next query. This is an efficient way to reduce waiting time and improve performance.

4.3 USDG Data Mode

The EKI-1526(TI) | 1528(TI) Series can function either as Data server or Data client. Both operations support TCP and UDP protocols. The Series allows you to treat your serial devices as if they were networking devices. You can issue commands or transmit data from serial devices, connected to a EKI-1526(TI) | 1528(TI) Series device, to any devices that are connected to the Internet.

4.3.1 USDG TCP Client Mode

In TCP Client mode, the TCP connection is established from the EKI serial device server. This operation mode supports a maximum of 16 simultaneous connections for each serial port on EKI-15xx series to one host or several hosts. You can configure the IP address and TCP port number of the network hosts connected to the EKI serial device server using the Advantech Serial Device Server Configuration Utility. After configuring the devices, when the EKI serial device server receives the data from the serial port, and the device server connects to the hosts which are configured.

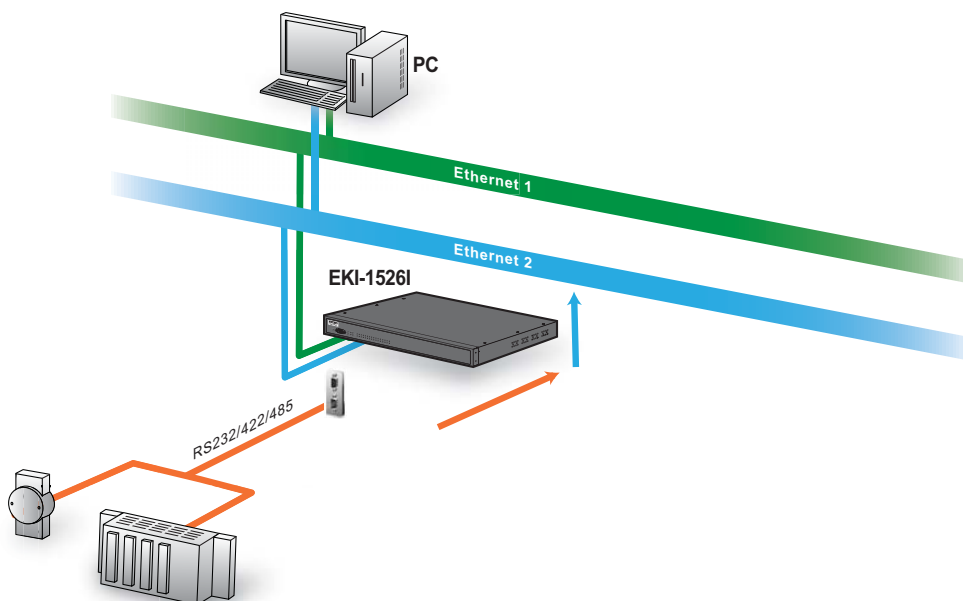

Figure 4.3 USDG TCP Client Mode

In USDG Data TCP Client mode, you may need to enable the peer numbers you would like to receive. You can set a maximum 16 network devices to which you may connect. You need to fill out the IP Address and Port (including local port and peer port) of each network device to which you want to connect.

In the Peer for Receiving Data menu, entering “LocalPort=0” as the value for the Local Port will assign a random TCP Port for an EKI device.

Peer for Receiving Data

Peer Number

#	Local Port	Peer IP address	Port
1	<input type="text" value="4657"/>	<input type="text" value="10.0.0.22"/>	<input type="text" value="6969"/>
2	<input type="text" value="0"/>	<input type="text"/>	<input type="text" value="0"/>
3	<input type="text" value="0"/>	<input type="text"/>	<input type="text" value="0"/>

Figure 4.4 Peer for Receiving Data

4.3.2 USDG Data TCP Server mode

In TCP server mode, the TCP connection is initiated from the host to the EKI serial device server. This operation mode supports a maximum of five simultaneous connections for each serial port on an EKI serial device server from a single or multiple hosts. However a multi-host connection simultaneously transmits the data from a single serial port.

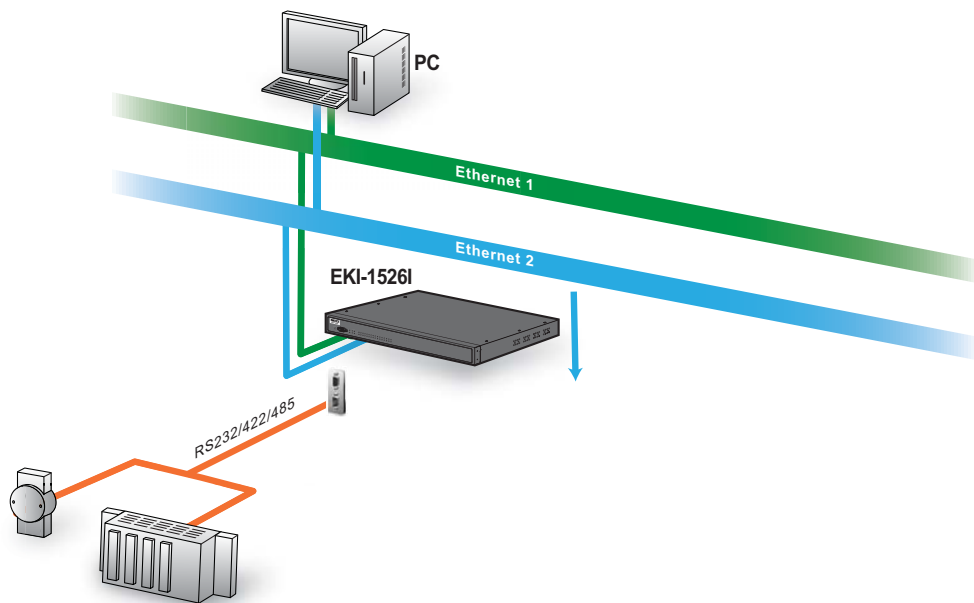

Figure 4.5 USDG TCP Server Mode

Port 1 configuration	
Mode	USDG Data Mode
Protocol	TCP
Data Idle Timeout(s)	60
Data Listen Port	5300
Command Listen Port	5400
Response Timeout(ms)	0

Figure 4.6 USDG Data Mode

4.3.3 USDG UDP Server/Client mode

The USDG UDP mode is primarily used for the broadcasting of messages over a network. In UDP server mode, data is transmitted from the Host connected to the EKI-1526(TI) | 1528(TI) USDG UDP Port (Default Port 5300). In the default UDP client mode, EKI serial device servers simultaneously transmits UDP messages to a maximum of 16 peers.

USDG Data mode supports Data Idle Timeout, Data Listen Port, and Command Listen Port parameters.

4.3.3.1 Data Idle Timeout

The default is 60 seconds. If you want to keep connection continually, you can disable the Data Idle Timeout. Data idle Time is the time period for which the device waits for data. If the EKI-1526(TI) | 1528(TI) does not receive data during established idle time, the EKI-1526(TI) | 1528(TI) will disconnect temporarily. When the data comes in, it will reconnect automatically. Users do not need to reconnect.

4.3.3.2 Data Listen Port

The TCP/UDP port number represents the source port number, and the number is used to identify the channel for remote initiating connections. The port range is 1024-65533. If an unknown caller wants to connect to the system and request services, they must define the TCP/UDP port to carry a long-term conversation.

Each node on a TCP/IP network has an IP address, and each IP address can allow connection on one or more TCP port. The well-known TCP ports are those that have been defined; for example, port 23 is used for Telnet connections. There are also custom sockets that users and developers define for their specific needs. The default TCP/UDP port of the EKI-1526(TI) | 1528(TI) Port1 is 5300, Port2 is 5301, etc. Users can adjust them according to preference or application. Each port has its own data listen port to accept the connection requests of other network device. The data listen port cannot be set to the same value. You can transmit/receive data to/from devices via the data listen port.

4.3.3.3 Command Listen Port

Each port has its own command listen port to accept connected request of other network device, so the command listen port cannot be set to the same value. The Command Listen Port is different from the Data Listen port.

4.4 USDG Control mode

In controlling mode, the EKI serial device server presents a modem interface to the attached serial device: it accepts AT-style modem commands to connect / disconnect to other networking device.

If you want a serial device running application program to connect/disconnect to different devices on request, this function is available through the USDG Control mode.

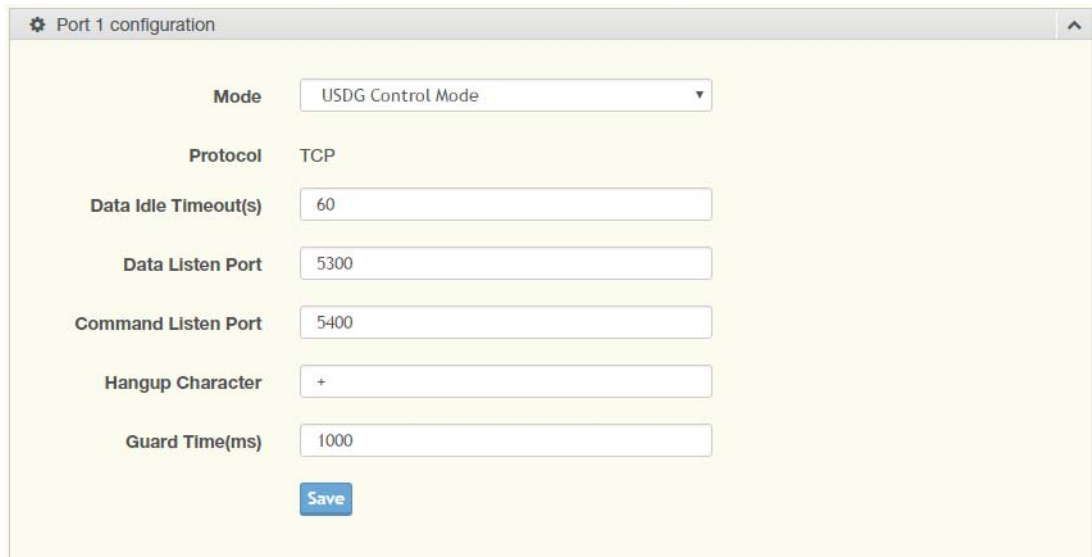

The screenshot shows a web-based configuration interface titled "Port 1 configuration". It features several input fields and a dropdown menu. The "Mode" dropdown is set to "USDG Control Mode". The "Protocol" is set to "TCP". The "Data Idle Timeout(s)" is set to "60". The "Data Listen Port" is set to "5300". The "Command Listen Port" is set to "5400". The "Hangup Character" is set to "+". The "Guard Time(ms)" is set to "1000". A blue "Save" button is located at the bottom of the form.

Figure 4.7 USDG Control Mode

Please refer to the USDG TCP/UDP server operating mode to setup the Data Listen Port, Command Listen Port, and Data Idle Timeout.

4.4.1 Hangup Character

The default character is "+". After you have connected to another serial device an via EKI device, you may need to disconnect, using the command "+++". To do this, press "+" three times and wait for the idle timeout <default value is 100ms>; the device will disconnect. You can set "Guard Time" to define the idle time.

4.4.2 Guard Time

The default value is 1000 ms.

Example: <Guard Time>+++<Guard Time>

Control Mode is designed for use with legacy operating systems, such as MSDOS, that do not support TCP/IP Ethernet. By connecting one of the EKI's serial ports to the MS-DOS computer's serial port, it is possible to use legacy software originally designed to transmit data via modem, but now transmitting data over the Ethernet.

Command	Function
ATD <IP address><TCP port><CR>	Forms a TCP connection to the specified host. Ex: ATD 192.0.55.22:5201 In above example, the EKI serial device server forms a raw TCP connection to the networking device (192.0.55.22). The TCP port is 5201.
ATA <CR>	Answering an incoming call
+++<CR>	Returns the user to the command prompt when entered from the serial port during a remote host connection.

Command	Function
<LF><CR> OK <LF><CR>	Commands are executed correctly
<LF><CR> CONNECT <LF><CR>	Connect to other device
<LF><CR> RING ddd.ddd.ddd <LF>< CR>	Detect the connection request from other device, which IP address is ddd.ddd.ddd.ddd.
<LF><CR> DISCONNECT <LF><CR>	Disconnect from other device
<LF><CR> ERROR <LF><CR>	Incorrect commands
<LF><CR> FAIL <LF><CR>	If you issue an ATDT command and can not connect to the device, it will response "FAIL".

4.5 RFC2217 Mode

RFC2217 mode is similar to virtual COM mode in that a driver is used to establish a transparent connection between a host computer and a serial device by mapping the serial port on EKI-1528 Series devices to a local COM port on a host computer. RFC2217 defines general COM port control options based on the Telnet protocol. Third party drivers supporting RFC2217 are widely available on the Internet and can be used to implement virtual COM mapping to the serial port of your device.

Chapter 5

Setting Up Virtual
COM Redirector

5.1 Setting COM Redirector

Advantech COM port mapping software is a serial COM port redirector that creates virtual COM ports and provides access to serial devices connected to an Advantech serial device servers. Your serial device applications can communicate with serial devices connected to the Advantech serial device servers without software changes.

Since the virtual COM ports work like standard Windows COM ports, your application software sees no difference between a local serial device and one connected to an Advantech serial device server.

The COM redirector utility and the virtual COM port management utility are integrated into one utility with same GUI. The Advantech EKI Device Configuration Utility can create all Virtual COM ports using the Auto Mapping function or by using the manual mapping function.

5.2 Virtual COM Port Mapping

5.2.1 Auto Mapping

1. On your desktop, navigate to **Start > All Programs > EKI Device Configuration Utility** and click **Advantech EKI Device Configuration Utility** to open the utility.
2. Under Serial Device Servers, locate **your server and click the icon to expand the listing**.
3. Select the target device and right-click on it to open up the options menu window.
4. Locate **Auto Mapping** and select it.

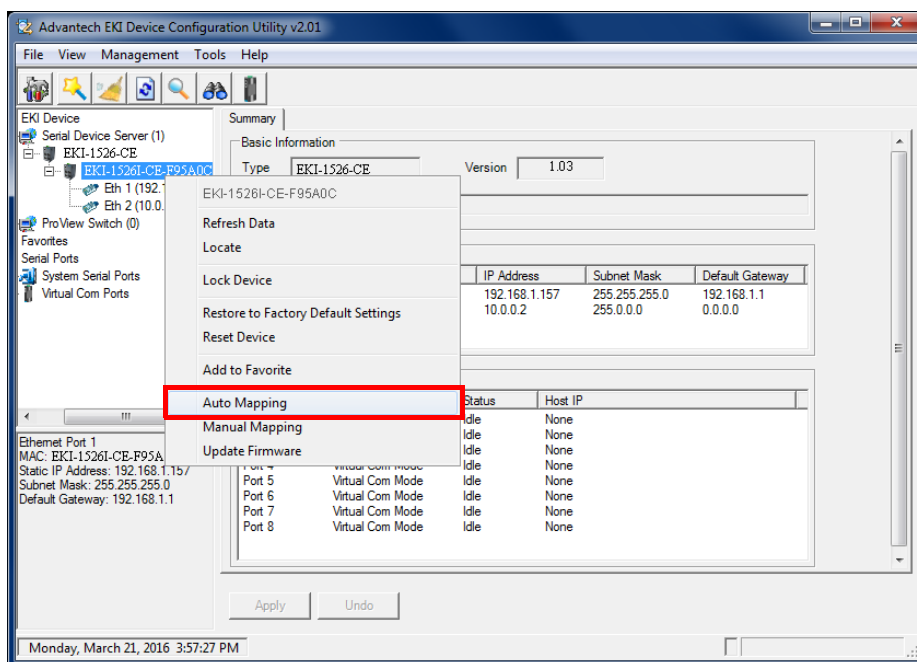

Figure 5.1 Selecting Auto Mapping

The **Batch Automatic Mapping Virtual COM Port** window displays.

5. Locate **From System Port** and click the drop-down menu to select the target COM port.
6. From the network address list, select the address options to map.

The selected address displays the Device Port and (EKI serial device server physical serial port) and the system port which will be the VCOM port for the PC.

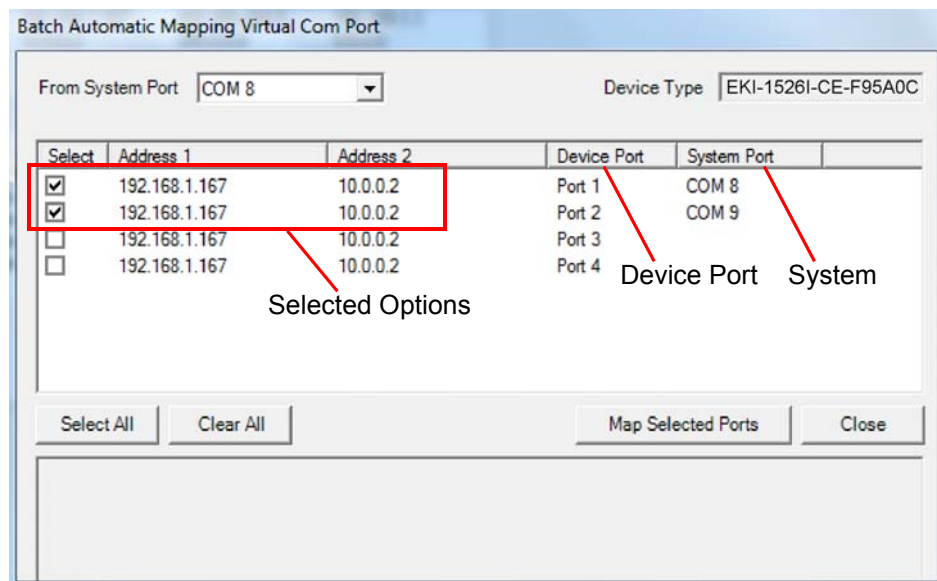

Figure 5.2 Selecting Auto Mapping

7. From the network address list, select the address options to map.
8. Click **Map Selected Ports** to set the configuration.

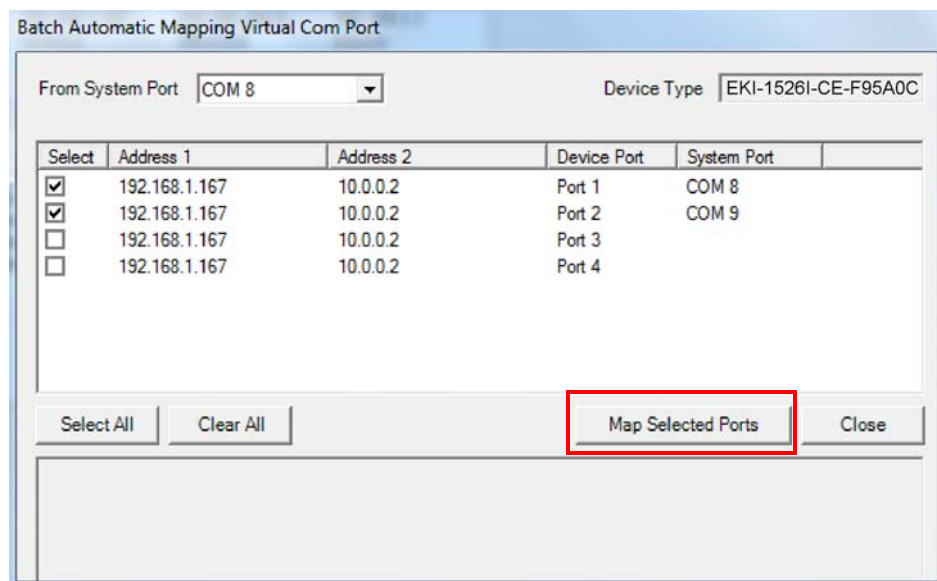

Figure 5.3 Mapping Selected Ports

Once the mapping function is initialized, a successful mapping process results in the virtual mapping of the designated physical serial port and VCOM PC port. See the following figure.

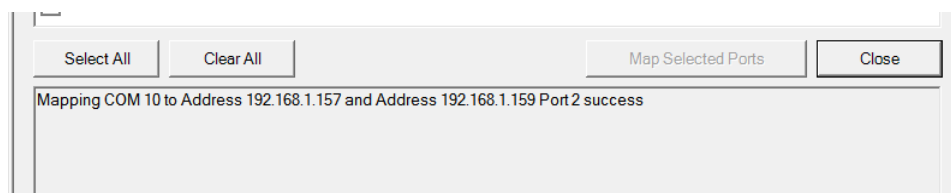

Figure 5.4 Viewing VCOM Mapping Results

5.2.2 Manual Mapping

1. On your desktop, navigate to **Start > All Programs > EKI Device Configuration Utility** and click **Advantech EKI Device Configuration Utility** to open the utility.
2. Under **Serial Device Servers**, locate your server and click the icon to expand the listing.
3. Select the target device and right-click on it to open up the options menu window.
4. Locate **Manual Mapping** and select it.

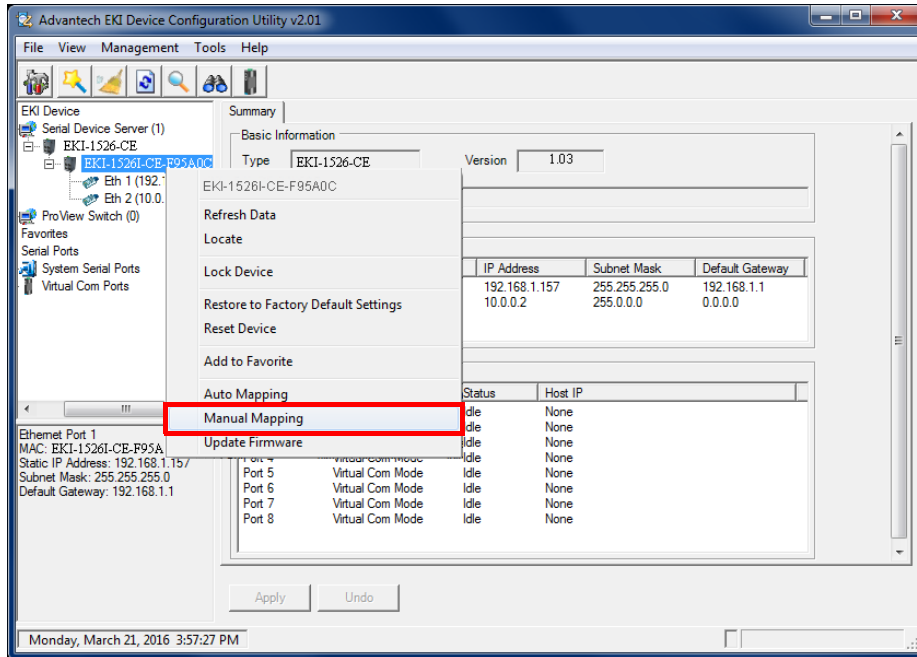

Figure 5.5 Selecting Manual Mapping

The **Manual Mapping Virtual COM Port** window displays.

5. In the **Device > Serial Port** drop-down menu, select the target port to map. This is the physical serial port on the EKI device.
6. In the **Host > COM Port** drop-down menu, select the target COM port to map. This is the virtual port on the target PC.

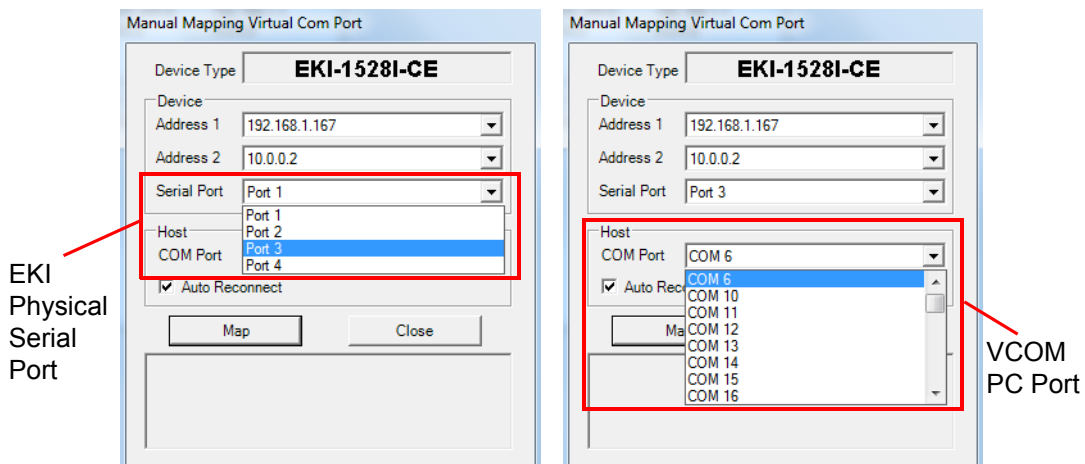

Figure 5.6 Selecting Manual Mapping

7. Click **Map it** to continue the process. The mapping process may require a short time. Once this step is completed, the **Manual Mapping Virtual COM Port** window displays again to map the VCOM port on the target PC.

Once the mapping function is initialized, a successful mapping process results in the virtual mapping of the designated physical serial port and VCOM PC port. See the following figure.

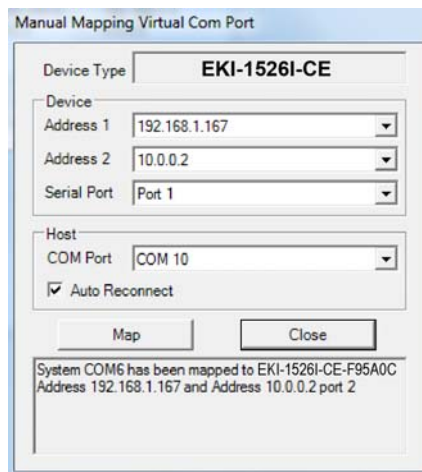

Figure 5.7 Viewing Manual VCOM Mapping Results

To allow for an automatic connection after a reboot or a power up, click the Auto Reconnect option to enable this function.

5.2.3 Configuration Wizard

1. On your desktop, navigate to **Start > All Programs > EKI Device Configuration Utility** and click **Advantech EKI Device Configuration Utility** to open the utility.
2. Under **Serial Device Servers**, locate your server and click the icon to expand the listing.
3. From the tool bar, select **Configuration Wizard**.

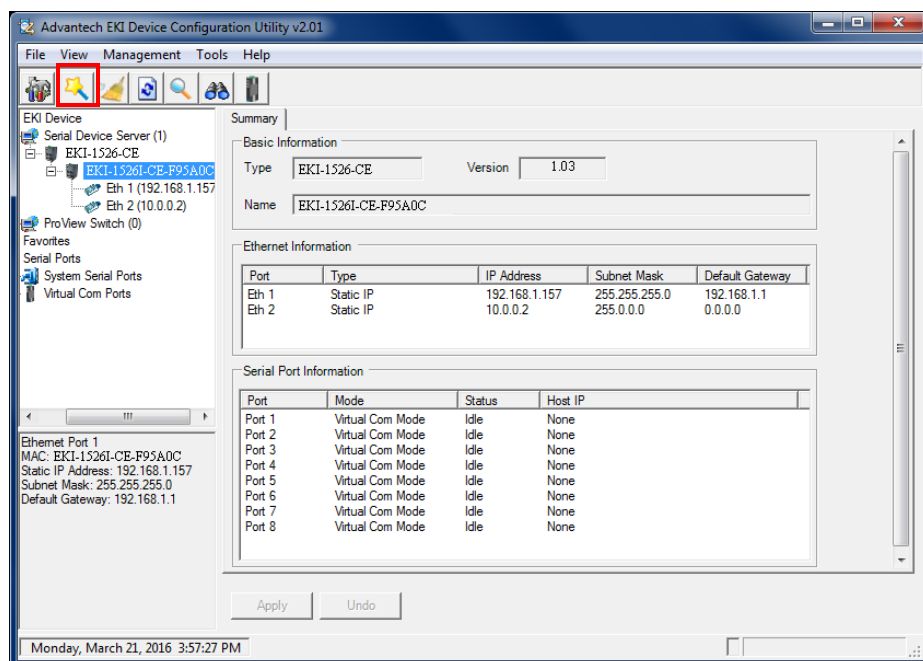

Figure 5.8 Selecting the Configuration Wizard

The Wizard screen displays and lists available devices.

4. Select the target device and click **Next** to continue. The Wizard Device Settings window displays.

- Under Serial Port Settings, click the **Type** drop-down menu and select the port type.
Review the settings under the Ethernet fields and verify them.
- Click **Next** to continue or **Previous** to return to the previous screen.
The selected settings are displayed in the following Wizard window.
- Locate the radio button correlating to the target port to modify and click on it to select it.
Verify the Device Port (EKI device physical serial port) and System Port (virtual COM port for PC) settings before continuing.
- Click **Finish** to complete the process. A Wizard complete! screen displays indicating the completion of a successful procedure.

5.2.4 Confirming Virtual COM Settings

- On your desktop, navigate to **Start > All Programs > EKI Device Configuration Utility** and click **Advantech EKI Device Configuration Utility** to open the utility.
- Locate **Serial Ports** menu in the menu pane and click on the Expand icon next to Virtual COM Ports to view a list of the mapped ports.
- Select a VCOM port to view its settings.

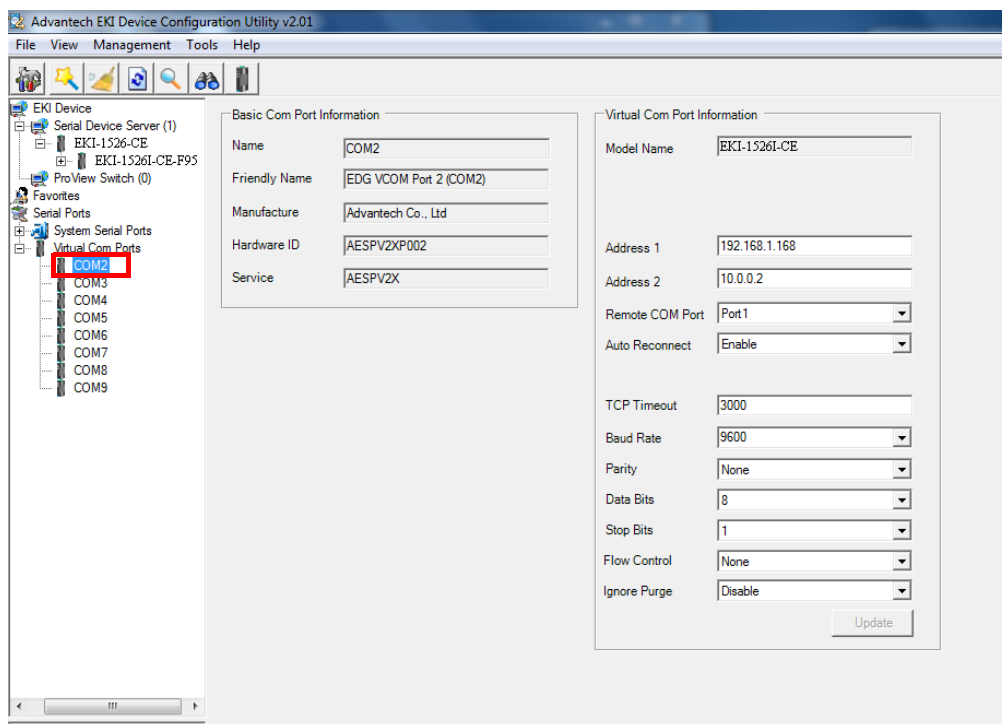

Figure 5.9 Serial Port Listing on EKI Device

For the next step, you will need to open the device manager on your system. Using the Device Manager, you can both view and change the COM port settings.

Note! *The following instructions are written for Windows 7; the Windows XP equivalent is displayed in parentheses (). The instructions may vary on other operating systems.*

- On your desktop, click on the **Start button** and then on **Control Panel**. A window displays showing all the available control panels.

5. Click on **Hardware and Sound (Hardware)**. A list of all available hardware configuration options displays.
6. Under **Devices and Printers**, click on the **Device Manager** link. A new window displays showing a list of all the available devices on your computer.
7. Locate **Ports (COM & LPT)** and click on the expand icon. A list of all available serial and parallel port devices display.
The newly mapped VCOM port should be listed under the same mapped settings used in the previous steps.

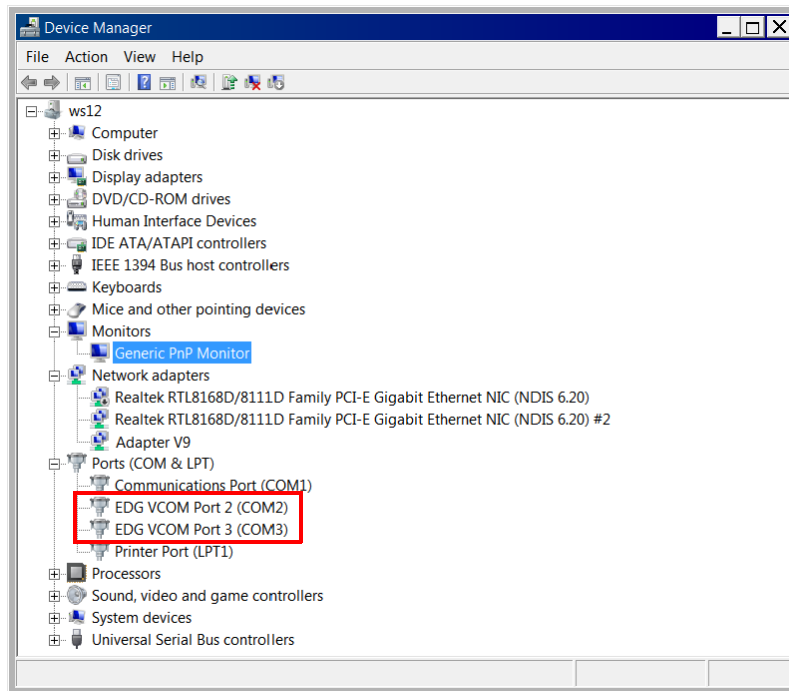

Figure 5.10 System Port VCOM Mapping Configuration

The newly mapped VCOM port is listed under the same mapped settings used in the previous steps. The settings correspond to the VCOM port configuration on the EKI device, see the following figure.

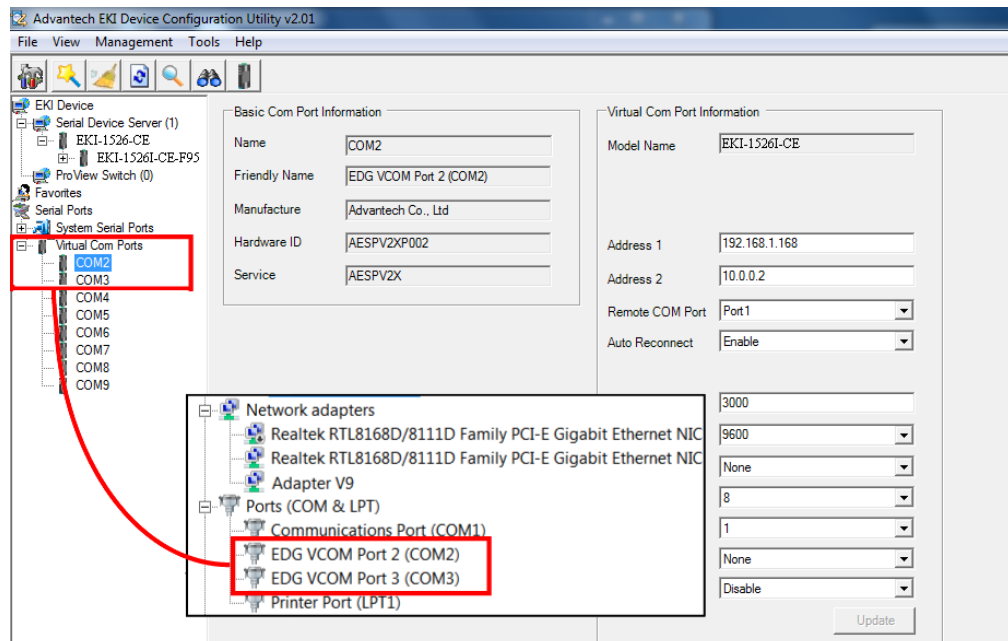

Figure 5.11 Verifying VCOM Mapping Configuration

If the settings do not correspond, the VCOM mapping is not correct. See “Virtual COM Port Mapping” on page 51 to re-map the VCOM ports.

5.2.5 Removing VCOM Ports

1. On your desktop, navigate to **Start > All Programs > EKI Device Configuration Utility** and click **Advantech EKI Device Configuration Utility** to open the utility.
2. Under Serial Ports, click the expand icon on Virtual COM Ports to view the configured port list.
3. Locate the port to remove and right-click on it to open the options menu.
4. Scroll down to **Remove This Port** and click on it to initiate the procedure.

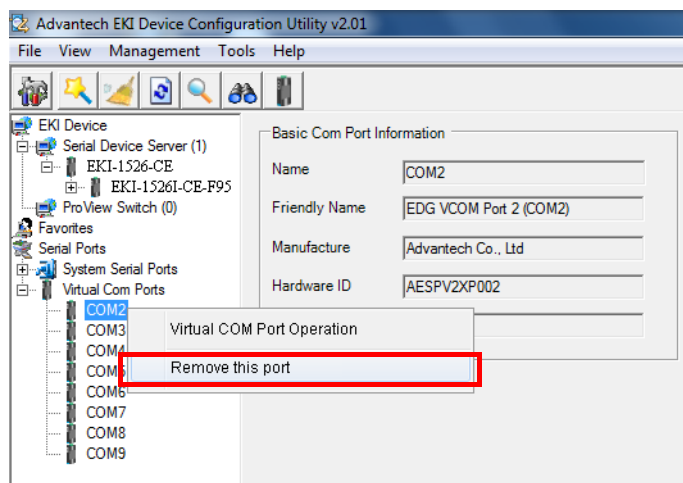

Figure 5.12 Accessing the Web Page through the EKI Device Configuration Utility

A Remove Port confirmation window displays.

5. Click **OK** to continue with the removal process or **Cancel** to return to the previous menu.

Once the procedure is completed, a prompt displays the successful removal of the port from the VCOM mapping list.

5.2.6 Exporting VCOM Mapping

The function is not available on EKI-1526N | EKI-1528N models.

The VCOM mapping settings can be exported for archiving or further use on remaining EKI serial device server.

Importing settings is supported through the EKI Device Configuration Utility.

To export VCOM mapping:

1. On your desktop, navigate to **Start > All Programs > EKI Device Configuration Utility** and click **Advantech EKI Device Configuration Utility** to open the utility.
2. Under **Serial Device Servers**, locate your server and click the icon to expand the listing.
3. Select the target device and right-click on it to open up the options menu window.
4. In the menu, select **Export Device Settings**.

A configuration (config) file with the server settings is downloaded to your default download folder.

5.2.7 Importing VCOM Mapping

The function is not available on EKI-1526N | EKI-1528N models.

The VCOM mapping settings can be imported from a previously saved configuration file.

Importing settings is supported through the EKI Device Configuration Utility.

To import VCOM mapping:

1. On your desktop, navigate to **Start > All Programs > EKI Device Configuration Utility** and click **Advantech EKI Device Configuration Utility** to open the utility.
2. Under **Serial Device Servers**, locate your server and click the icon to expand the listing.
3. Select the target device and right-click on it to open up the options menu window.
4. In the menu, select **Import Device Settings**.
5. An explorer window displays, locate the configuration (config) file with the server settings and click **Open** to select the file.

Once the file is selected, the new settings are imported into the EKI serial device server.

5.3 Running a Diagnostic Test

The loopback test allows you to determine if the EKI serial device server is configured correctly to identify any failed nodes in the network. The test allows you to send a signal from the server and return (looped back) it back to the server.

1. Connect the loopback connector to a COM port on the EKI serial device server.
2. On your desktop, navigate to **Start > All Programs > EKI Device Configuration Utility** and click **Advantech EKI Device Configuration Utility** to open the utility.
3. Under Serial Ports, click the expand icon on Virtual COM Ports to view the configured port list.
4. Open the ICOMToolsPlus utility to open the EKI serial device server settings.
5. Set the COM port configuration to match the Port Configuration.
6. Click the **Start** menu.

A successful loopback test incrementally displays the Bytes/sec values on both displayed menus.

Chapter 6

Web Configuration

6.1 Overview

EKI-1526(TI) | 1528(TI) serial device servers can be configured through a web interface. By using a standard web browser, the same procedure as with the Windows configuration utility can be used. In the browser's address field, enter the IP Address of your EKI-1526(TI) | 1528(TI) serial device server.s The default IP setting is 10.0.0.1, but you should use the IP which you have previously assigned for this device. Once the IP is entered, you will be presented with the following windows.

Note! *Before using the web-based configuration, make sure your host PC Ethernet network IP domain is as same as the serial device server, or it can establish the TCP connection with the serial device server.*



Note! *It is recommended that you use Microsoft Internet Explorer 7.0 or higher.*



6.2 Accessing the Web Page

6.2.1 Accessing the Web Page via Configuration Utility

To access the web page via configuration utility:

1. Select Ethernet under the desired device.
2. Click **Launch Browser**.

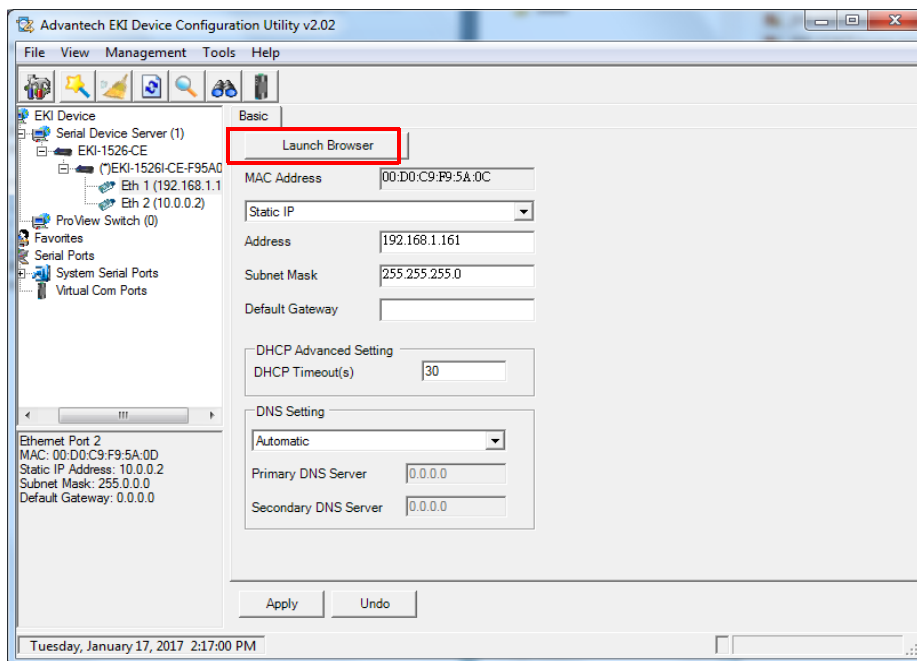

Figure 6.1 Accessing the Web Page via Configuration Utility

6.2.2 Accessing the Web Page via Web Browser

Once the device is installed and connected, power on the device. The following information guides you through the logging in process.

1. Launch your web browser on the PC.
2. In the browser's address bar, type the device's default IP address (Eth1: 10.0.0.1, Eth2: 10.0.0.2).
3. The main interface displays.

6.3 System

You can change the Device Name and Device Description on this page. You can also enable or disable the Telnet and SNMP functions. Moreover, you can set the Timezone related settings.

To access this page, click **System**.

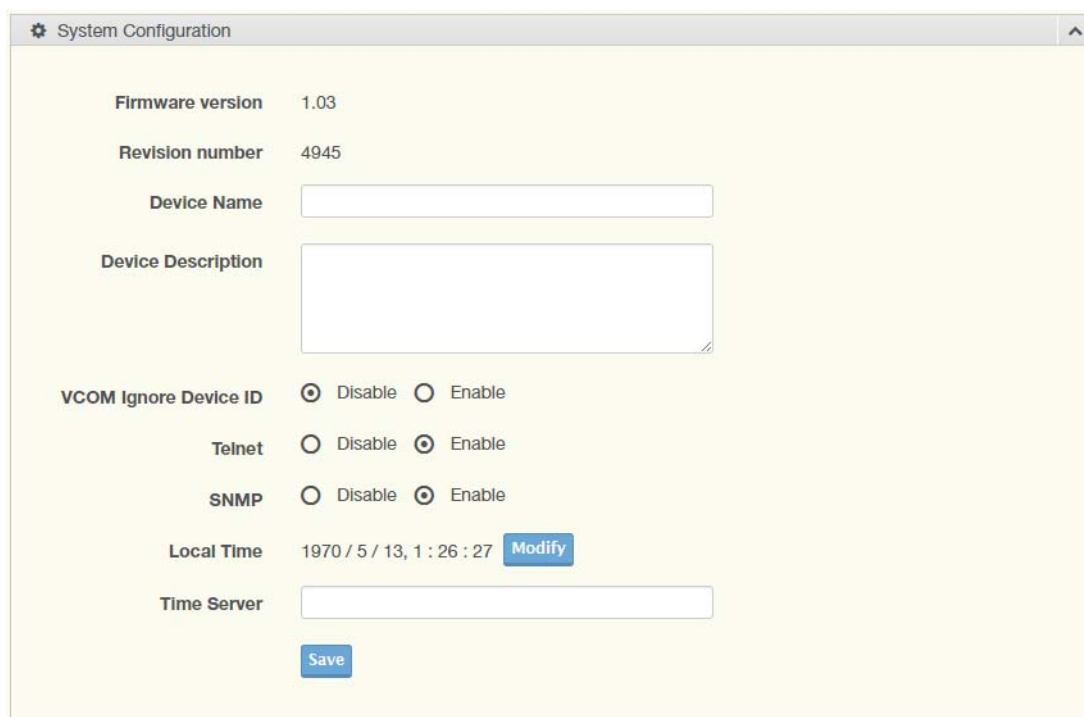

Figure 6.2 System

The following table describes the items in the previous figure.

Item	Description
Firmware version	Displays the current firmware version of the device.
Revision number	Displays the revision number of the device.
Device Name	Enter the device name: up to 31 alphanumeric characters.
Device Description	Enter the device description.
Telnet	Click Enabled or Disabled to set remote access through the Telnet Service function.
VCOM Ignore Device ID	
SNMP	Click Enabled or Disabled to define the SNMP daemon.
Local Time	Click Modify to set local date and time of the system.

Item	Description
Time Server	Enter the address of the SNTP server. This is a text string of up to 64 characters containing the encoded unicast IP address or hostname of a SNTP server. Unicast SNTP requests will be sent to this address. If this address is a DNS hostname, then that hostname should be resolved into an IP address each time a SNTP request is sent to it.
Save	Click Save to save the values and update the screen.

6.4 Ethernet Configuration

Choose either **Eth 1** or **Eth 2** in the Ethernet Configuration page. Enter the corresponding values for your network environment. Remember press **Save** after fill in all values.

To access this page, click **Ethernet Configuration**.

Figure 6.3 Ethernet Configuration

The following table describes the items in the previous figure.

Item	Description
IPv4 Configuration	
Mode	Click the drop-down menu to select the IP Address Setting mode: Static IP, DHCP, or BOOTP.
MAC Address	Enter the MAC address to which packets are statically forwarded.
IP Address	Enter a value to specify the IP address of the interface. The default is 10.0.0.1 (Eth1) & (0.0.0.2 (Eth2).
Subnet Mask	Enter a value to specify the IP subnet mask for the interface. The default is 255.0.0.0.
Default Gateway	Enter a value to specify the default gateway for the interface.

Item	Description
DNS Configuration	
DNS	Click the radio button to select the DNS mode: Automatic or Specific.
Current Status	
IP 1	Displays the current IP address 1 of the device.
IP 2	Displays the current IP address 2 of the device.
Save	Click Save to save the values and update the screen.

Note! All new configurations will take effect after rebooting. To reboot the device, click **Tools > Reboot**.



6.5 Port Configuration

There are Basic, Operation Mode, and Advanced Setting in the serial port configuration. For more detailed information for setting.

6.5.1 Basic

The Basic menu allows for the configuration of the serial interface type, baud rate, parity, data / stop bits, and flow control for port configuration.

To access this page, click **Port Configuration > Basic**.

The screenshot shows the 'Port 1 configuration' page with the 'Basic' tab selected. The settings are as follows:

- Type: RS232
- Baud Rate: 9600
- Parity: None
- Data Bits: 8
- Stop Bits: 1
- Flow Control: None

A blue 'Save' button is located at the bottom of the configuration area.

Figure 6.4 Port Configuration > Basic

The following table describes the items in the previous figure.

Item	Description
Type	Click the drop-down menu to select a serial interface: RS-232, RS-422 or RS-485.
Baud Rate	Enter a value to specify the baud rate. The value should conform to the current transmission speeds of connected devices when setting the baud rate.
Parity	Click the drop-down menu to select the parity: None, Odd, Even, Mark or Space.
Data Bits	Click the drop-down menu to select the data bits: 5, 6, 7, or 8.

Item	Description
Stop Bits	Click the drop-down menu to select the stop bits: 1, 1.5 or 2.
Flow Control	Click the drop-down menu to select the flow control mode: None, XOn/XOff, RTS/CTS or DTR/DSR
Save	Click Save to save the values and update the screen.

6.5.2 Operation

The Operation menu allows for the configuration of the mode type and related attributes for port configuration.

To access this page, click **Port Configuration > Operation**.

Figure 6.5 Port Configuration > Operation

The following table describes the items in the previous figure.

Item	Description
Mode	Click the drop-down menu to select the port configuration mode: Virtual COM Mode, USDG Data Mode, USDG Control Mode or RFC2217 Mode.
Virtual COM Mode	
Host Idle Timeout (s)	Enter a value to define the host idle timeout period.
Response Timeout (ms)	Enter a value to define the response timeout period.
Frame Break (ms)	Enter a value to specify the frame break time.

Item	Description
Pack conditions (Pack sent immediately when reach 1024 Bytes)	
By size	Click the option to send pack immediately by size.
By interval	Click the option to send pack immediately by interval.
By end-character	Click the option to send pack immediately by end-character.
Port Data Buffering	
Port Data Buffering	Click the drop-down menu to select port data buffering type: None or RAM.
When Data Full	Click the drop-down menu to select process mode when data full: Stop.
USDG Data Mode	
Protocol	Click the drop-down menu to select the protocol: TCP or UDP.
Data Idle Timeout (s)	Enter a value to define the data idle timeout period.
Data Listen Port	Enter a value to identify the channel for remote initiating connections.
Command Listen Port	Enter a value to identify the command listen port for accepting connected request of other network device.
Response Timeout (ms)	Enter a value to define the response timeout period.
Frame Break (ms)	Enter a value to specify the frame break time.
TCP Mode Extra Options	
Auto Connect To Peer IP	Click the option to connect to TCP/IP which are set at Peers page automatically after boot up.
Port Data Buffering	
Media	Click the drop-down menu to select port data buffering type: None or RAM.
When Data Full	Click the drop-down menu to select process mode when data full: Stop.
Pack conditions (Pack sent immediately when reach 1024 Bytes)	
By size	Click the option to sent pack immediately by size.
By interval	Click the option to sent pack immediately by interval.
By end-character	Click the option to sent pack immediately by end-character.
By character-timeout	Click the option to sent pack immediately by character-timeout.
Peer for Receiving Data	
Peer Number	Click the drop-down menu to select the number of network device which you want to connect. Maximum is 16 network devices.
USDG Control Mode	
Protocol	Display the current protocol of the USDG control mode.
Data Idle Timeout (s)	Enter a value to define the data idle timeout period.
Data Listen Port	Enter a value to identify the channel for remote initiating connections.
Command Listen Port	Enter a value to identify the command listen port for accepting connected request of other network device.
Hang up Character	The default character is "+". After you have connected to another serial device via an EKI device, you may need to disconnect, using the command "+++". To do this, press "+" three times and wait for the idle timeout <default value is 100ms>; the device will disconnect. You can set "Guard Time" to define the idle time.
Guard Time (ms)	Enter a value to identify the guard time.
RFC2217 Mode	
Listen Port	Enter a value to identify the channel for remote initiating connections.

Item	Description
Host Idle Timeout (s)	Enter a value to define the host idle timeout period.
Save	Click Save to save the values and update the screen.

6.5.3 Advanced

The Advanced menu allows for the configuration of the time delay, buffer data size and FIFO size for port configuration.

To access this page, click **Port Configuration > Advanced**.

Figure 6.6 Port Configuration > Advanced

The following table describes the items in the previous figure.

Item	Description
Enable Delay Time	Click the option to enter the value to postpone the receive data.
Ignore Purge	Click the option to purge the serial port when the serial port opens first time.
Disable Character Timeout Detection	Click the option to disable the serial port character timeout detection.
Disable Multiple Connection	Click the option to disable the multi-access function. Then only one TCP connection is allowed on this serial port.

Item	Description
Enable BufferData Size	Click the option to enter the value to queue data to become a packet.
Port Timeout	Settings determine the time period that received data from serial port is postponed. Click the option to enter the value to define the timeout period.
RTL	Receiver Trigger Level Click the option to determines how often or when the receiver interrupt is be triggered.
TTL	Transmitter Trigger Level Click the option to designate to suspend or resume transmission.
FCL	Flow Control Lower Trigger Levels Click to set register for automatic flow control. FCL stores the lower trigger level.
FCH	Flow Control Higher Trigger Level Click to set register for automatic flow control. FCH stores the upper trigger level.
Write to FIFO Size	Click the option to determines the maximum characters will be wrote into one interrupt.
USDG Advanced Options (Flow Control will overwrite these options)	
RTS Control	Click the drop-down menu to select the status of RTS: ON, OFF, Toggle By Connect or Toggle By Data.
DTR Control	Click the drop-down menu to select the status of DTR: ON, OFF, Toggle By Connect or Toggle By Data.
Save	Click Save to save the values and update the screen.

6.6 Monitor

The EKI serial device server provides the function that allows monitoring of the serial ports' status. The serial port's operation mode and status is available for display. The IP address of the host PC which is communicating with serial port is also displayed.

The Monitor function provides a method to monitor the serial device server's status (operation mode, baud rate, data bits, stop bits, parity and RTS/XON/DTR).

Monitoring information is divided into three main message types: Setting/Statistic/Connected IP.

6.6.1 Setting

The Monitor Setting page allows for easy viewing of the port's statistics. To access this page, click **Monitor > Setting**.

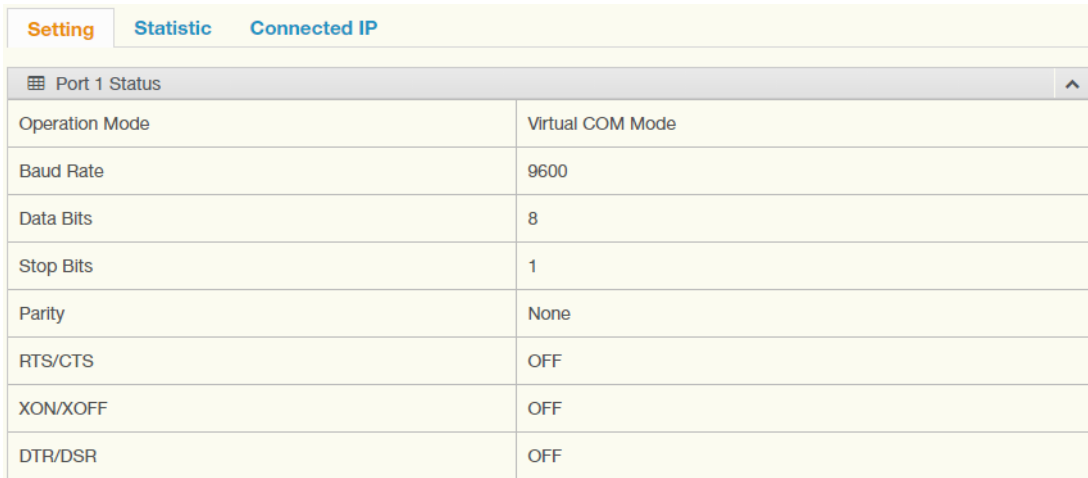

Port 1 Status	
Operation Mode	Virtual COM Mode
Baud Rate	9600
Data Bits	8
Stop Bits	1
Parity	None
RTS/CTS	OFF
XON/XOFF	OFF
DTR/DSR	OFF

Figure 6.7 Monitor > Setting

The following table describes the items in the previous figure.

Item	Description
Operation Mode	Display the current operation mode of the selected port.
Baud Rate	Display the current baud rate of the selected port.
Data Bits	Display the current data bits of the selected port.
Stop Bits	Display the current stop bits of the selected port.
Parity	Display the current parity of the selected port.
RTS/CTS	Display the current RTS/CTS status of the selected port.
XON/XOFF	Display the current XON/OFF status of the selected port.
DTR/DSR	Display the current DTR/DSR status of the selected port.

6.6.2 **Statistic**

The Monitor Statistic page allows for easy viewing of the port's TX/RX data count. To access this page, click **Monitor > Statistic**.

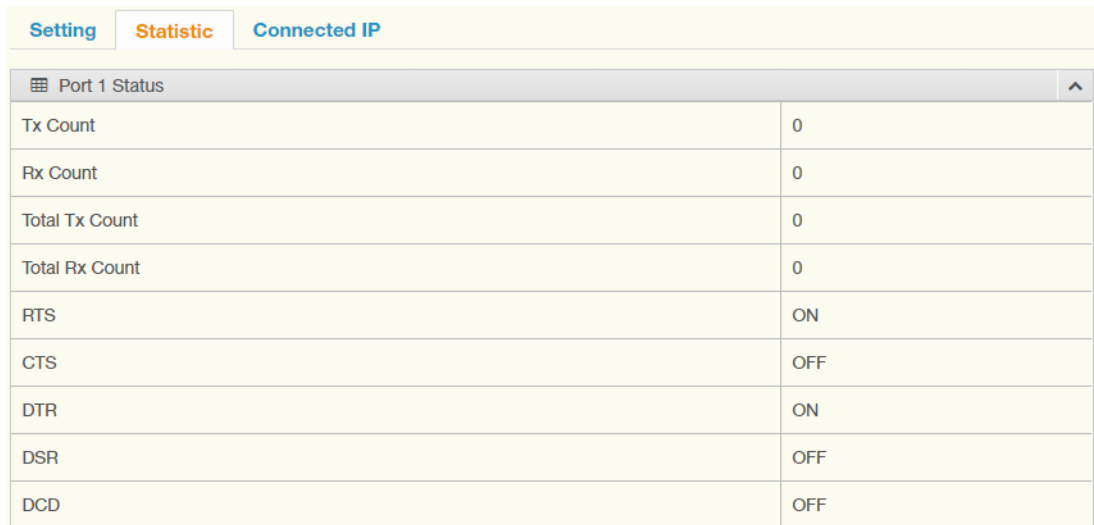

Setting	Statistic	Connected IP
Port 1 Status		
Tx Count	0	
Rx Count	0	
Total Tx Count	0	
Total Rx Count	0	
RTS	ON	
CTS	OFF	
DTR	ON	
DSR	OFF	
DCD	OFF	

Figure 6.8 Monitor > Statistic

The following table describes the items in the previous figure.

Item	Description
Tx Count	Display the current Tx count of the selected port.
Rx Count	Display the current Rx count of the selected port.
Total Tx Count	Display the current total Tx count of the selected port.
Total Rx Count	Display the current total Rx count of the selected port.
RTS	Display the current RTS status of the selected port.
CTS	Display the current CTS status of the selected port.
DTR	Display the current DTR status of the selected port.
DSR	Display the current DSR status of the selected port.
DCD	Display the current DCD status of the selected port.

6.6.3 Connected IP

The Monitor Connected IP page allows for easy viewing of all connected device's IP address.

To access this page, click **Monitor > Connected IP**.

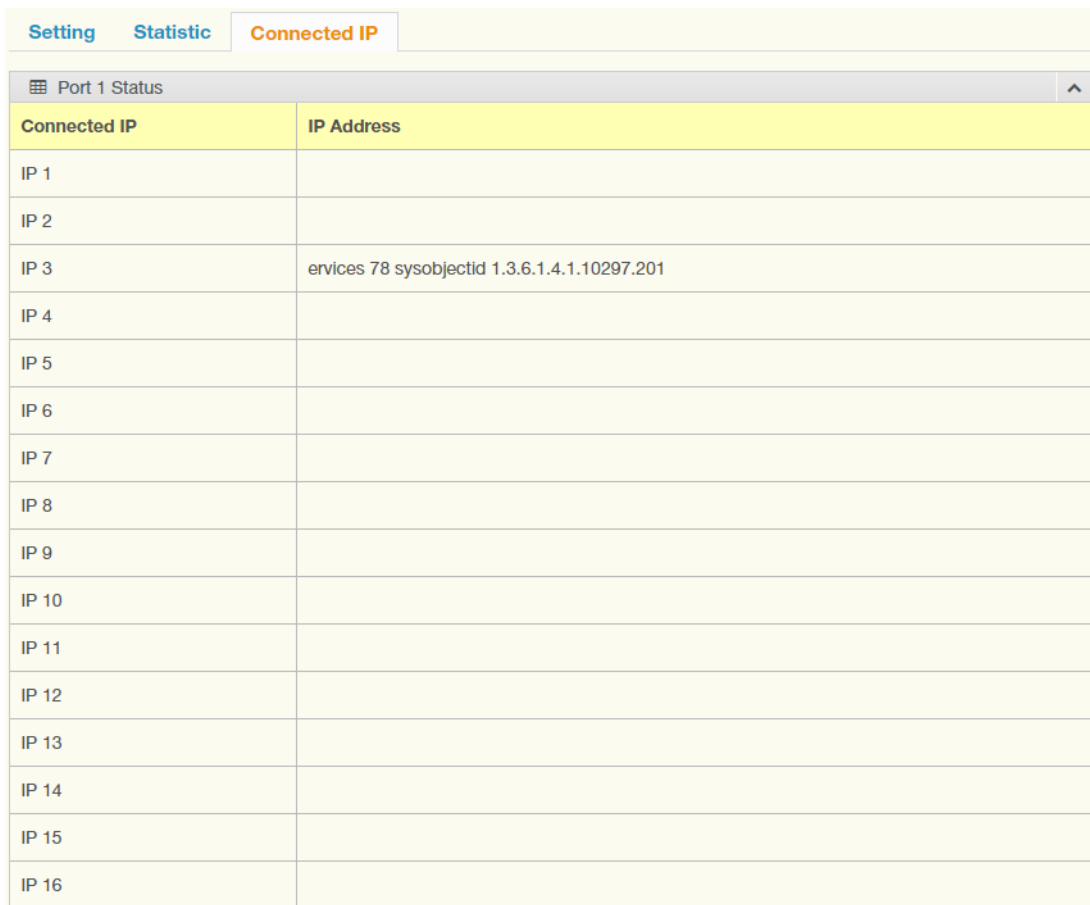

Connected IP	IP Address
IP 1	
IP 2	
IP 3	ervices 78 sysobjectid 1.3.6.1.4.1.10297.201
IP 4	
IP 5	
IP 6	
IP 7	
IP 8	
IP 9	
IP 10	
IP 11	
IP 12	
IP 13	
IP 14	
IP 15	
IP 16	

Figure 6.9 Monitor > Connected IP

The displayed attributes are not configurable in this menu, and are for information purposes only.

Item	Description
Connected IP	Displays the IP designation for the device.
IP Address	Displays the current connected IP address of the selected port.

6.7 Alert

On the Alert Settings page, you may configure how administrators are notified by certain system, network, configuration, power, and cellular connection events. Rely on the events, administrators can collect different options for automatic notification. **Mail** refers to send an e-mail to a specified mail address. **Trap** refers to send an SNMP Trap. **Agent** refers to send the SNMP agent setting.

6.7.1 Setting

To access this page, click **Alarm > Setting**.

The screenshot shows the 'Alarm Setting' configuration page. It is organized into three main sections separated by dashed lines:

- Mail Server:** Contains a 'Mail Server' text input field, a 'From Email address' text input field with the value 'admin@advantech.com', and four 'Email address 1' through 'Email address 4' text input fields.
- SNMP Trap Server:** Contains a 'Trap Server' text input field, a 'Trap Server Port' text input field with the value '162', a 'Trap Version' section with radio buttons for 'v1' (selected) and 'v2c', and a 'Trap Community' text input field with the value 'public'.
- SNMP Agent Setting:** Contains four text input fields labeled 'Read Community', 'Write Community', 'Contact', and 'Location'.

A blue 'Save' button is positioned at the bottom center of the form.

Figure 6.10 Alarm > Setting

The following table describes the items in the previous figure.

Item	Description
Mail Server	
Mail Server	This field is for your mail server's domain name or IP address.
From Email address	This is the e-mail address from which automatic e-mail warnings will be sent.
Email addresses 1-4	This is the e-mail address or addresses to which the automatic e-mail warnings will be sent.
SNMP Trap Server	

Item	Description
Trap Server	Use this field to indicate the IP address to use for receiving SNMP traps.
Trap Server Port	Enter the SNMP Trap server port.
Trap Version	(default = v1): Use this field to select the SNMP trap version.
Trap Community	Use this field to designate the SNMP trap community.
SNMP Agent Setting	
Read Community	Read community name of your agent.
Write Community	Write community name of your agent.
Contact	Identify the system contact of your agent.
Location	Identify the system location of your agent.
Save	Click Save to save the values and update the screen.

6.7.2 Event

In this page, you can configure events which will trigger logging or notification. You can select three methods (Mail, SNMP, or log file) to record or send event messages. System event notification is available for cold start, warm start, authentication failure, IP address/Password change, serial DCD/DSR port change and Ethernet link down information.

To access this page, click **Alarm > Event**.

⚙ Event Type ^

System Event

Cold Start	<input type="checkbox"/>	Mail	<input type="checkbox"/>	Trap	<input type="checkbox"/>	Log
Warm Start	<input type="checkbox"/>	Mail	<input type="checkbox"/>	Trap	<input type="checkbox"/>	Log
Authentication failure	<input type="checkbox"/>	Mail	<input type="checkbox"/>	Trap	<input type="checkbox"/>	Log
IP address changed	<input type="checkbox"/>	Mail				
Password changed	<input type="checkbox"/>	Mail				
Ethernet1 link down	<input type="checkbox"/>	Mail	<input type="checkbox"/>	Trap	<input type="checkbox"/>	Log
Ethernet2 link down	<input type="checkbox"/>	Mail	<input type="checkbox"/>	Trap	<input type="checkbox"/>	Log

DCD changed

Port 1	<input type="checkbox"/>	Mail	<input type="checkbox"/>	Trap	<input type="checkbox"/>	Log
Port 2	<input type="checkbox"/>	Mail	<input type="checkbox"/>	Trap	<input type="checkbox"/>	Log
Port 3	<input type="checkbox"/>	Mail	<input type="checkbox"/>	Trap	<input type="checkbox"/>	Log
Port 4	<input type="checkbox"/>	Mail	<input type="checkbox"/>	Trap	<input type="checkbox"/>	Log
Port 5	<input type="checkbox"/>	Mail	<input type="checkbox"/>	Trap	<input type="checkbox"/>	Log
Port 6	<input type="checkbox"/>	Mail	<input type="checkbox"/>	Trap	<input type="checkbox"/>	Log
Port 7	<input type="checkbox"/>	Mail	<input type="checkbox"/>	Trap	<input type="checkbox"/>	Log
Port 8	<input type="checkbox"/>	Mail	<input type="checkbox"/>	Trap	<input type="checkbox"/>	Log

DSR changed

Port 1	<input type="checkbox"/>	Mail	<input type="checkbox"/>	Trap	<input type="checkbox"/>	Log
Port 2	<input type="checkbox"/>	Mail	<input type="checkbox"/>	Trap	<input type="checkbox"/>	Log
Port 3	<input type="checkbox"/>	Mail	<input type="checkbox"/>	Trap	<input type="checkbox"/>	Log
Port 4	<input type="checkbox"/>	Mail	<input type="checkbox"/>	Trap	<input type="checkbox"/>	Log
Port 5	<input type="checkbox"/>	Mail	<input type="checkbox"/>	Trap	<input type="checkbox"/>	Log
Port 6	<input type="checkbox"/>	Mail	<input type="checkbox"/>	Trap	<input type="checkbox"/>	Log
Port 7	<input type="checkbox"/>	Mail	<input type="checkbox"/>	Trap	<input type="checkbox"/>	Log
Port 8	<input type="checkbox"/>	Mail	<input type="checkbox"/>	Trap	<input type="checkbox"/>	Log

Figure 6.11 Alarm > Event

The following table describes the items in the previous figure.

Item	Description
System Event	
Cold Start	Click the option to select a warning type when the device server's power is cut off and reconnected.
Warm Start	Click the option to select a warning type when the device server is reboot.
Authentication failure	Click the option to select a warning type when an incorrect password is entered.
IP address changed	Click the option to select a warning type when the IP address is changed.
Password changed	Click the option to select a warning type when the password is changed.
Ethernet1 link down	Click the option to select a warning type when the Ethernet 1 port is disconnected.
Ethernet2 link down	Click the option to select a warning type when the Ethernet 2 port is disconnected.
DCD changed	
Port	Click the option to select a warning type of the selected port when a change in the DCD (Data Carrier Detect) signal indicates that the modem connection status has changed.
DSR changed	
Port	Click the option to select a warning type of the selected port when a change in the DSR (Data Set Ready) signal indicates that the data communication equipment is powered off.
Save	Click Save to save the values and update the screen.

6.8 Syslogd

The EKI serial device server provides the functionality to allow network devices to send event messages to a logging server, also known as a Syslog server, by way of the Syslogd function. The Syslog protocol is supported by a wide range of devices and can be used to log different types of events.

6.8.1 Syslogd Setting

Users can enable the syslogd function to record historical events or messages locally or on a remote syslog server.

To access this page, click **Syslogd > Syslogd Setting**.



Figure 6.12 Syslogd > Syslogd Setting

The following table describes the items in the previous figure.

Item	Description
Syslogd	Click Enabled or Disabled to set the logging service status.
Save	Click Save to save the values and update the screen.

6.8.2 Syslogd Message

After enabling the syslogd function, users can check the history in the syslogd message page.

To access this page, click **Syslogd** > **Syslogd Message**.



Figure 6.13 Syslogd > Syslogd Message

6.9 Tools

The EKI serial device server provides tools for access to ping and reset functions.

6.9.1 Ping

The ping page can help users diagnose ethernet problems. Users can use the ping page to ask the device to ping a specific target to check the Ethernet network status.

The Ping page allows you to configure the test log page.

To access this page, click **Tools > Ping**.

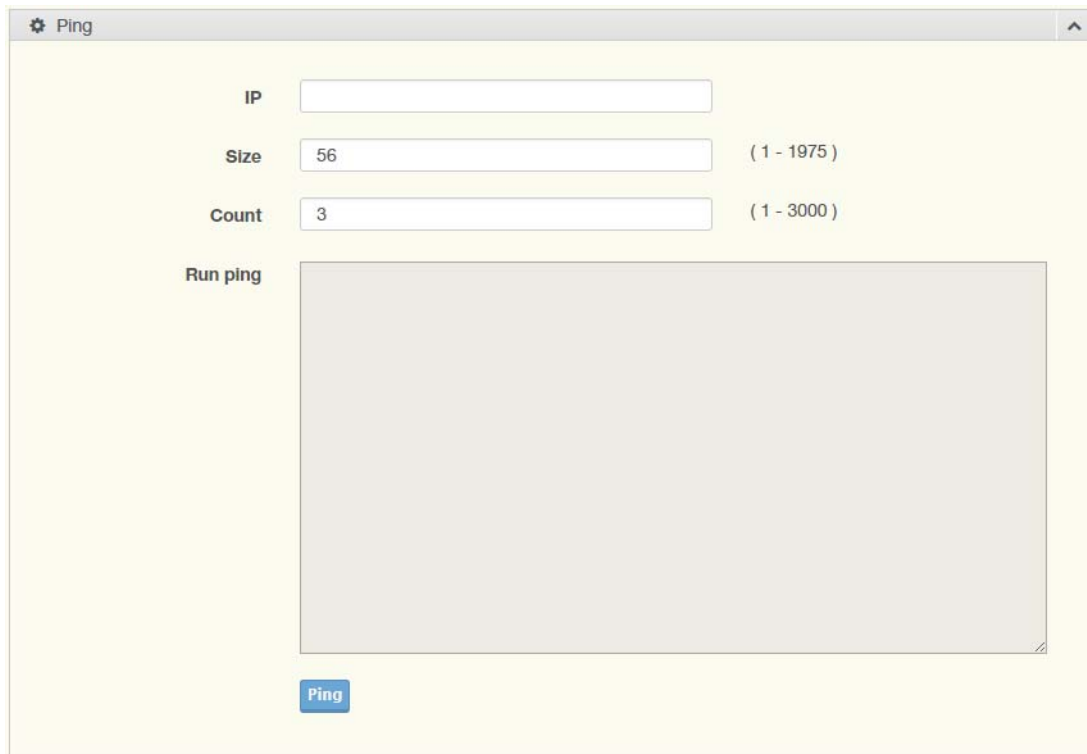

Figure 6.14 Tools > Ping

The following table describes the items in the previous figure.

Item	Description
IP	Enter the IP address or host name of the station to ping. The initial value is blank. The IP Address or host name you enter is not retained across a power cycle. Host names are composed of series of labels concatenated with periods. Each label must be between 1 and 63 characters long, maximum of 64 characters.
Size	Enter the size of ping packet. The default value is 56. The value ranges from 8 to 5120. The size entered is not retained across a power cycle.
Count	Enter the number of echo requests to send. The default value is 4. The value ranges from 1 to 5. The count entered is not retained across a power cycle.
Run ping	Display the ping reply format.
Ping	Click Ping to start ping remote station.

6.9.2 Reboot

The configuration will take effect after clicking Save button. But all configurations are saved to flash memory after a system reboot. Press the Reboot button and the system will give a reset response. It will take a few seconds to reconnect with the new values.

To access this page, click **Tools > Reboot**.

Click **Reboot** to reboot the serial device server. Any configuration changes you have made since the last time you saved will be lost.

6.10 Management

The EKI serial device server allows for easy installation and maintenance and reliable maintenance access from anywhere. With the reliable management tools available, you can streamline staffing and troubleshooting requirements to a centralized system.

6.10.1 Log File

If users enable the system event or serial event to log in file, users can download the log file from here.

To access this page, click **Management > Log File**.



Figure 6.15 Management > Log File

The following table describes the items in the previous figure.

Item	Description
System Log File	Click the drop-down menu to select a specific action for the system log file. Available options: Download System Log, Remove System Log, Download and Remove System Log.
Save	Click Save to save the values and update the screen.

6.10.2 Change Password

The Change Password function allows you to easily update your current password from a single menu.

To access this page, click **Management > Change Password**.



Figure 6.16 Management > Change Password

The following table describes the items in the previous figure.

Item	Description
Old password	Enter the old password.
New password	Enter the character set for the define password type.
New password again	Retype the password entry to confirm the profile password.
Save	Click Save to save the values and update the screen.

If you have set a password through the configuration utility or Telnet or serial console, when you access the web configuration, you need to key in the password. It is not necessary to enter the user name in the dialog.

If you want to disable the password protection, change the password to default option **None** (leave the new password column blank). Be sure to press the **Save** button and reboot the serial device server to make the change effective.

6.10.3 Secure access IP

The Secure Access IP function allows you to assign single or multiple user access to data transmission through a serial device server.

Access is configured as follows: Set Access IP number to 0: unrestricted access

Set Access IP number to greater than 0: restricted to listed Access IP listing.

To access this page, click **Management > Secure access IP**.



Figure 6.17 Management > Secure access IP

The following table describes the items in the previous figure.

Item	Description
Access IP number	Click the drop-down menu to select the number of IP addresses to define (0 to 32). The default setting (0) disables this setting.
Save	Click Save to save the values and update the screen.

6.10.4 Export Device Settings

Export the server configuration settings to a .conf file.

To access this page, click **Management > Export**.

Click **Export** to export the serial device server settings.

6.10.5 Import Device Settings

Import the server configuration settings to a .conf file.

To access this page, click **Management > Import**.

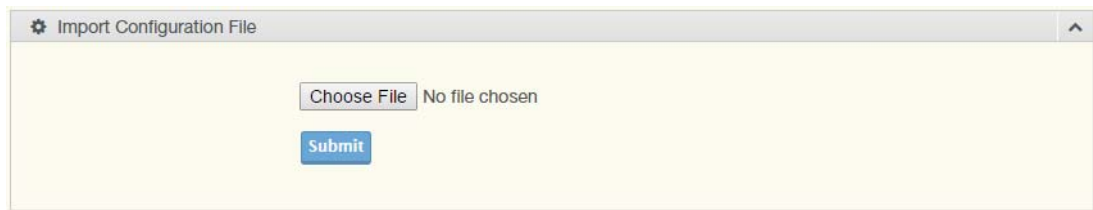

Figure 6.18 System

The following table describes the items in the previous figure.

Item	Description
Choose File	Click Choose File to select the configuration file.
Submit	Click Submit to backup the settings.

Chapter 7

Telnet

7.1 Overview

The purpose of the Console Configuration is to help you manage your device in console mode. One of the main functions of the console mode is to change the web configuration login password. You can use terminal software like Hyper Terminal, Telix and other related terminal software.

7.2 Telnet Console

7.2.1 Create a new connection

You can create a new Telnet connection and assign a connection name for the console configuration.



Figure 7.1 Creating a Telnet Connection

7.2.2 Input the IP address

Confirm that the Telnet console configuration works ok. Be sure that your host PC Ethernet network IP domain is as same as the EKI-1526(TI) | 1528(TI) device server, and the Telnet TCP port number is “23”.

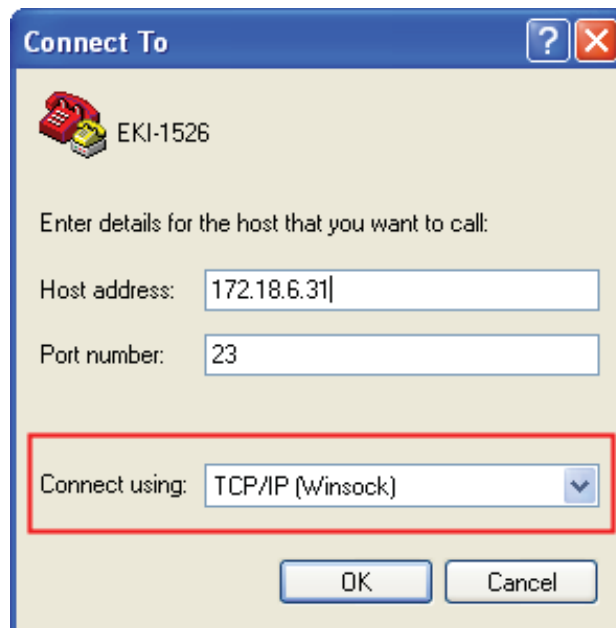

Figure 7.2 Creating a Telnet Connection

7.2.3 Connection Success

After connecting to the serial device server in HyperTerminal console, a welcome greeting displays.

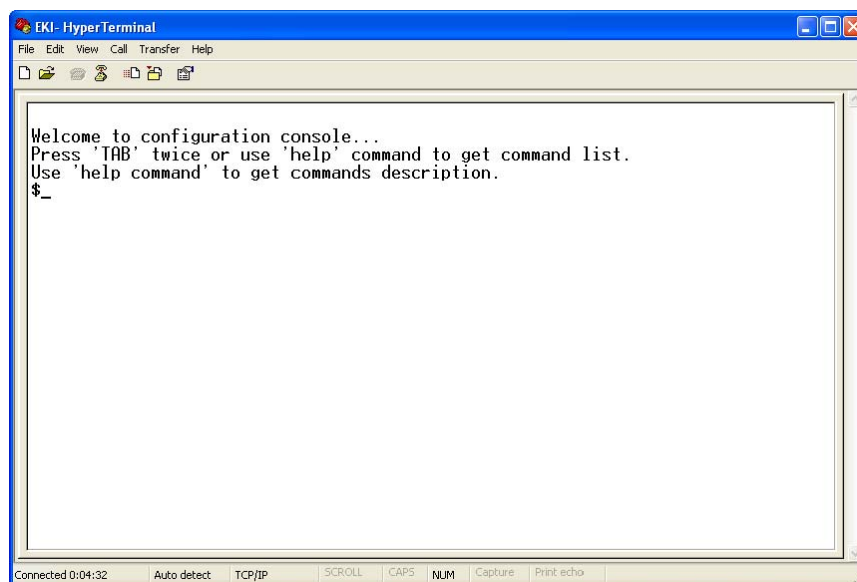

Figure 7.3 Telnet Connection Console

At the command prompt, you can type a “help” followed by the Enter button, or <Tab> twice, to display the command list.

You can toggle between the different command menu options.

7.3 Serial Console

7.3.1 Connecting the cable

You can connect to the EKI-1526(TI) | 1528(TI) serial device server's console port with a RS-232 DB9 M-type communication cable, with the other end connecting to the host's serial port. Make sure the connection is OK and then run the Hyper Terminal Program on your host.



Figure 7.4 Creating a Serial Connection

7.3.2 Select the COM port

Confirm that the console configuration works ok.

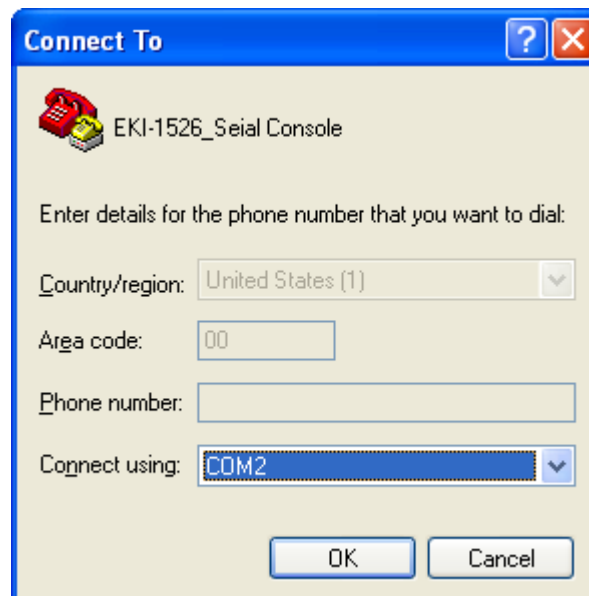

Figure 7.5 Creating a Serial Connection

7.3.3 COM Port Settings

To connect the EKI-1526(TI) | 1528(TI) device server for console configuration, the port setting should match the EKI-1526(TI) | 1528(TI) device sever default settings.

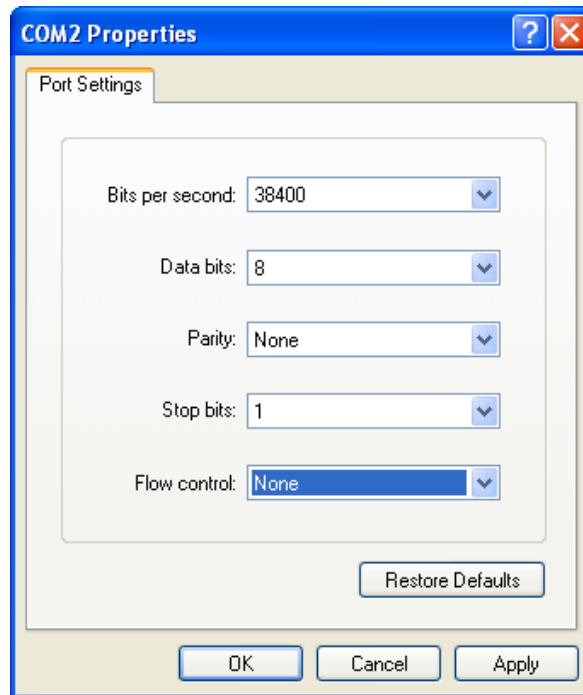

Figure 7.6 COM Port Settings

Console configuration default Settings:

- Baud rate: 38400
- Data bits: 8
- Parity: None
- Stop bits: 1
- Flow control: None

7.3.4 Connection Success

After connecting the device in console mode, you can simply press <Enter> to enter the console configuration.

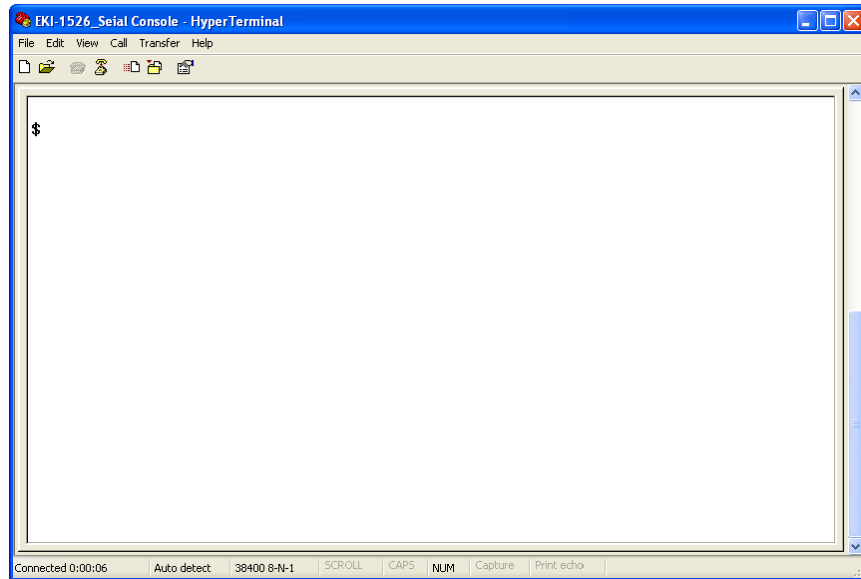

Figure 7.7 Connection success

7.4 Command List

Command	Function Description
system	Show or configure the system information
port	Show or configure the serial ports information
portadv	Show or configure the serial ports advanced settings
mvcom	Show or configure the serial ports in Virtual COM mode
mctr	Show or configure the serial ports in Control mode (USDG)
mdata	Show or configure the serial ports in Data mode (USDG)
net	Show or configure the Ethernet ports settings
password	Set or change the password
alarm	Show or configure the auto warning functions including mail alarm and SNMP alarm
monitor	Monitor the serial ports status
mrfc2217	Show all port modes and mode information.
apply	Write settings to the flash memory and reboot the system immediately
exit	Terminate the shell session
help	Display command list help information
reboot	Write settings and reboot the system immediately.

7.4.1 system

Usage: system

Show current device status and informations.

Usage: system name [Maximum length 31 bytes]

Set current device name.

Usage: system desc [Maximum length 127 bytes]

Set current device description.

7.4.2 port

Usage: port [nn|all]

Show port status and informations.

Usage: port [nn] desc [Maximum length 127 bytes]

Set serial port description.

Usage: port [nn|all] type [232|422|485] flow []

Set serial port type and flow control.

- flow 0:None.
- flow 1:XOn/XOff.
- flow 2:RTS/CTS.
- flow 3:DTR/DSR.

Usage: port [nn|all] baud [50-921600] parity [] data [5-8] stop [1|1.5|2]

Set serial baud rate, parity and numbers of data bits, numbers of stop bits.

Acceptable baud: 50 75 110 150 300 600 1200 1800 2400 4800 7200 9600
14400 19200 38400 57600 115200 230400 460800 921600

- parity n: None Parity.
- parity e: Even Parity.
- parity o: Odd Parity.
- parity m: Mark Parity.
- parity s: Space Parity.

Usage: port [nn|all] mode [vcom|ctrl|data]

Set serial port as virtual COM port or control mode or data mode.

7.4.3 portadv

\$ help portadv

Show port advanced setting.

Usage: portadv [nn|all] delayT []

Set delay time(ms).

Usage: portadv [nn|all] ignorepurge [TRUE|FALSE] dischato [TRUE|FALSE]
dismulticon [TRUE|FALSE]

Enable or disable the feature of ignore purge.

Disable character timeout detection, and disable multiple connection.

Usage: portadv [nn|all] databuf []

Set databuffer threshold.

Usage: portadv [nn|all] timeout [] rtl [] ttl [] fcl [] fch []

Set port timeout, and set portrtl, portttl, portfcl, portfch.

Usage: portadv [nn|all] fifosize [size|null]

Set port Writed size of FIFO, null for disable.

Usage: portadv [nn|all] rts []

Set port RTS status.

- value 0 :None Setting.
- value 1 :Setting power on.
- value 2 :Setting accept on.
- value 4 :Setting transmission on.

Usage: portadv [nn|all] dtr []
Set port DTR status.

- value 0 :None Setting.
- value 1 :Setting power on.
- value 2 :Setting accept on.
- value 4 :Setting transmission on.

7.4.4 mvcom

Usage: mvcom
Show all port mode and mode informations.

Usage: mvcom [nn|all]
Set port [nn|all] as virtual COM port mode.

Usage: mvcom [nn|all] idletimeout []
Set host idle timeout(s).

Usage: mvcom [nn|all] resptimeout [] framebreak []
Set response timeout(ms) and frame break(ms).

Usage: mvcom [nn|all] bytesize []
Usage: mvcom [nn|all] bytime []
Usage: mvcom [nn|all] bychar [NULL]
Set datapackage as size(bytes) or time(ms) and character(HEX) .

- value 0 : None Setting.

7.4.5 mctrl

Usage: mctrl
Show port mode and mode informations.

Usage: mctrl [nn|all]
Set port [nn|all] as control mode.

Usage: mctrl [nn|all] idletimeout [] tcpport [] atport [] guardtime [] hangupchar []
Set data idle timeout(s) data listen port command listen port guard time(ms)
hangup character.

7.4.6 mdata

Usage: mdata
Show port mode and mode informations.

Usage: mdata [nn|all]
Set port [nn|all] as data mode.

Usage: mdata [nn|all] protocol [TCP|UDP]
Set transmit protocol as TCP or UDP.

Usage: mdata [nn|all] idletimeout [] listenport [] atport []
Set data idle timeout(s) listen port and AT command port.

Usage: mdata [nn|all] resptimeout [] framebreak []
Set response timeout(ms) and frame break(ms).

Usage: mdata [nn|all] bytesize [] bytime [] bychar [NULL] bychartimeout [ON|OFF]
Set datapackage as size(bytes) or time(ms) or character(HEX) and
character timeout.

- value 0 : None Setting.

Usage: mdata [nn|all] autopeerip [ON|OFF]

Set auto connect to peer ip as on or off.

Usage: mdata [nn|all] peernum [1-16] peer [d.d.d.d:d] ...

Set peer IP address and port for receive data.

7.4.7 net

Usage: net [1|2]

Show device network status and informations.

Usage: net [1|2] mode [static|dhcp|bootp|all]

Set network operating mode.

Usage: net [1|2] ip [d.d.d.d] netmask [d.d.d.d] gw [d.d.d.d]

Set IP address and subnet mask and gateway.

Usage: net [1|2] dns [auto|specific]

Enable/Disable DNS.

Usage: net [1|2] dns1 [d.d.d.d]

Set network DNS1.

Usage: net [1|2] dns2 [d.d.d.d]

Set network DNS2.

Usage: net [1|2] to [d]

Set network timeout.

7.4.8 password

Usage: password

Display two different Usage.

Usage: password new [1-31 characters]

Set new password.

Usage: password old [**...] new [1-31 characters]

Confirm the old password and set new password.

7.4.9 alarm

Usage: alarm

Show current alarm informations.

Usage: alarm mail server [null|address] from [null|address] to1 [null|address] to2 [null|address] to3 [null|address] to4 [null|address]

Set current mail server configuration.

Usage: alarm trap server [null|address] ver [1|2] community [null|name]

Set current trap server configuration.

Usage: alarm agent rcommunity [null|name] wcommunity [null|name] contact [null|name] location [null|name]

Set current snmp agent configuration.

Usage: alarm event mail [cstart] [wstart] [auth] [ip] [passwd] [eth1] [eth2]

Set current mail event configuration.

Usage: alarm event trap [cstart] [wstart] [auth] [eth1] [eth2]

Set current trap event configuration.

Usage: alarm port [1|2]..] dcd [none|mail|trap|all] dsr [none|mail|trap|all]

Set current port alarm configuration.

7.4.10 monitor

Usage: monitor port [1|2|..] setting
Monitor COM port setting

Usage: monitor port [1|2|..] statistic
Monitor COM port statistic data

Usage: monitor port [1|2|..] ip
Monitor connected IP

7.4.11 time

Usage: time
Show current time informations.

Usage: time [YYYYMMDDhhmmss]
Set current time configuration.

Usage: time ntp [timeserver]
Set current time server configuration.

7.4.12 service

Usage: service telnet [enable|disable]
Enable/Disable telnet function

Usage: service snmp [enable|disable]
Enable/Disable SNMP function

7.4.13 mrfc2217

Usage: mrfc2217
Show all port mode and mode informations.

Usage: mrfc2217 [nn|all]
Set port [nn|all] as RFC2217 mode.

Usage: mrfc2217 [nn|all] idleto [] lsport []
Set host idle timeout(s) and listen port.

7.4.14 apply

Usage: apply
Save the settings to flash and reboot right now.

7.4.15 exit

Usage: exit
Terminate shell session

7.4.16 help

Usage: help [cmd]
Display help information of command cmd

7.4.17 reboot

Usage: reboot
Write settings and reboot the system immediately.

Chapter 8

TCP and UDP Port
Numbers

8.1 List of Known TCP and UDP Port Numbers

Port	Protocol	Service
5048	(TCP/UDP)	Configuration Utility
5058	(TCP/UDP)	Configuration Utility
5202	(TCP)	VCOM/RVCOM
9999	(TCP)	Firmware Download
22	(TCP)	SSH
23	(TCP)	Telnet
25	(TCP)	SMTP (Mail Client)
53	(TCP/UDP)	DNS
67	(UDP)	BOOTP Server/DHCP
68	(UDP)	BOOTP Client/DHCP
80	(TCP)	Web Interface/HTTP
123	(TCP)	NTP
161	(TCP)	SNMP
162	(TCP/UDP)	SNMP Trap
443	(TCP)	HTTPS
502	(TCP)	Modbus/TCP (Default)
514	(TCP)	Syslog
546	(TCP/UDP)	DHCPv6 Client
547	(TCP/UDP)	DHCPv6 Server

ADVANTECH

Enabling an Intelligent Planet

www.advantech.com

Please verify specifications before quoting. This guide is intended for reference purposes only.

All product specifications are subject to change without notice.

No part of this publication may be reproduced in any form or by any means, electronic, photocopying, recording or otherwise, without prior written permission of the publisher.

All brand and product names are trademarks or registered trademarks of their respective companies.

© Advantech Co., Ltd. 2016