

Schottky Diode

$$V_{RRM} = 200\text{ V}$$

$$I_{FAV} = 15\text{ A}$$

$$V_F = 0.78\text{ V}$$

High Performance Schottky Diode
 Low Loss and Soft Recovery
 Single Diode

Part number

DSA15IM200UC

Marking on Product: SFMAUI

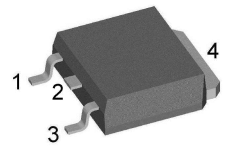

Backside: cathode

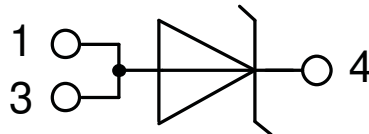

Features / Advantages:

- Very low V_f
- Extremely low switching losses
- Low I_{rm} values
- Improved thermal behaviour
- High reliability circuit operation
- Low voltage peaks for reduced protection circuits
- Low noise switching

Applications:

- Rectifiers in switch mode power supplies (SMPS)
- Free wheeling diode in low voltage converters

Package: TO-252 (DPak)

- Industry standard outline
- RoHS compliant
- Epoxy meets UL 94V-0

Disclaimer Notice

Information furnished is believed to be accurate and reliable. However, users should independently evaluate the suitability of and test each product selected for their own applications. Littelfuse products are not designed for, and may not be used in, all applications. Read complete Disclaimer Notice at www.littelfuse.com/disclaimer-electronics.



Schottky				Ratings			
Symbol	Definition	Conditions		min.	typ.	max.	Unit
V_{RSM}	max. non-repetitive reverse blocking voltage					200	V
V_{RRM}	max. repetitive reverse blocking voltage					200	V
I_R	reverse current, drain current	$V_R = 200\text{ V}$		$T_{VJ} = 25^\circ\text{C}$		250	μA
		$V_R = 200\text{ V}$		$T_{VJ} = 125^\circ\text{C}$		2.5	mA
V_F	forward voltage drop	$I_F = 15\text{ A}$		$T_{VJ} = 25^\circ\text{C}$		0.94	V
		$I_F = 30\text{ A}$				1.10	V
		$I_F = 15\text{ A}$		$T_{VJ} = 125^\circ\text{C}$		0.78	V
		$I_F = 30\text{ A}$				0.95	V
I_{FAV}	average forward current	$T_C = 150^\circ\text{C}$	rectangular	$T_{VJ} = 175^\circ\text{C}$		15	A
V_{FO}	threshold voltage	} for power loss calculation only		$T_{VJ} = 175^\circ\text{C}$		0.53	V
r_F	slope resistance					10.8	m Ω
R_{thJC}	thermal resistance junction to case					2	K/W
R_{thCH}	thermal resistance case to heatsink				0.50		K/W
P_{tot}	total power dissipation			$T_C = 25^\circ\text{C}$		75	W
I_{FSM}	max. forward surge current	$t = 10\text{ ms}; (50\text{ Hz}), \text{ sine}; V_R = 0\text{ V}$		$T_{VJ} = 45^\circ\text{C}$		200	A
C_J	junction capacitance	$V_R = 24\text{ V}$	$f = 1\text{ MHz}$	$T_{VJ} = 25^\circ\text{C}$		67	pF



Package TO-252 (DPak)			Ratings			
Symbol	Definition	Conditions	min.	typ.	max.	Unit
I_{RMS}	RMS current	per terminal ¹⁾			20	A
T_{VJ}	virtual junction temperature		-55		175	°C
T_{op}	operation temperature		-55		150	°C
T_{stg}	storage temperature		-55		150	°C
Weight				0.3		g
F_C	mounting force with clip		20		60	N

¹⁾ I_{RMS} is typically limited by the pin-to-chip resistance (1); or by the current capability of the chip (2). In case of (1) and a product with multiple pins for one chip-potential, the current capability can be increased by connecting the pins as one contact.

Product Marking

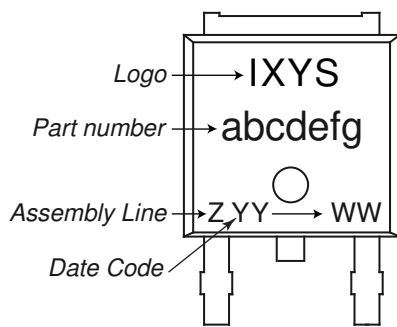

Part description

- D = Diode
- S = Schottky Diode
- A = low VF
- 15 = Current Rating [A]
- IM = Single Diode
- 200 = Reverse Voltage [V]
- UC = TO-252AA (DPak)

Ordering	Ordering Number	Marking on Product	Delivery Mode	Quantity	Code No.
Standard	DSA15IM200UC-TRL	SFMAUI	Tape & Reel	2500	510408
Alternative	DSA15IM200UC-TUB	SFMAUI	Tube	70	523494

Similar Part	Package	Voltage class
DSB15IM30UC	TO-252AA (DPak)	30
DSA15IM45UC	TO-252AA (DPak)	45
DSA10IM100UC	TO-252AA (DPak)	100
DSA15IM150UC	TO-252AA (DPak)	150

Equivalent Circuits for Simulation

* on die level

$T_{VJ} = 175\text{ °C}$

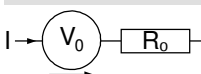

Schottky

$V_{0\ max}$	threshold voltage	0.53	V
$R_{0\ max}$	slope resistance *	7.6	mΩ



Outlines TO-252 (DPak)

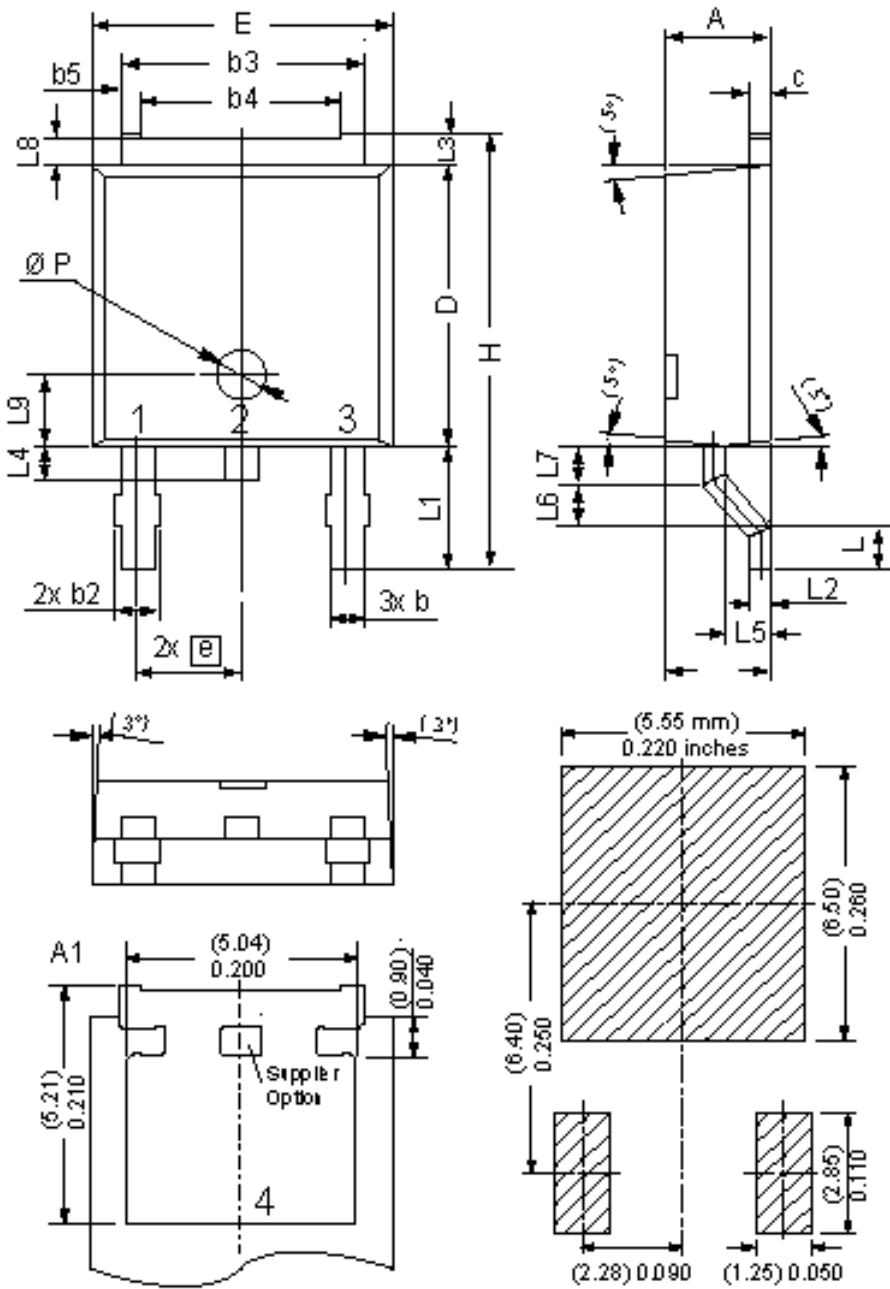

Dim	Millimeters		Inches	
	min	max	min	max
A	2.20	2.40	0.087	0.094
A1	2.10	2.50	0.083	0.098
b	0.66	0.86	0.026	0.034
b2	-	0.96	-	0.038
b3	5.04	5.64	0.198	0.222
b4	4.34 BSC		0.171 BSC	
b5	0.50 BSC		0.020 BSC	
c	0.40	0.86	0.016	0.034
D	5.90	6.30	0.232	0.248
E	6.40	6.80	0.252	0.268
e	2.10	2.50	0.083	0.098
H	9.20	10.10	0.362	0.398
L	0.55	1.28	0.022	0.050
L1	2.50	2.90	0.098	0.114
L2	0.40	0.60	0.016	0.024
L3	0.50	0.90	0.020	0.035
L4	0.60	1.00	0.024	0.039
L5	0.82	1.22	0.032	0.048
L6	0.79	0.99	0.031	0.039
L7	0.81	1.01	0.032	0.040
L8	0.40	0.80	0.016	0.031
L9	1.50 BSC		0.059 BSC	
Ø P	1.00 BSC		0.039 BSC	

Recommended
min. foot print

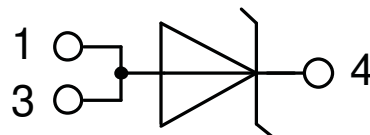



Schottky

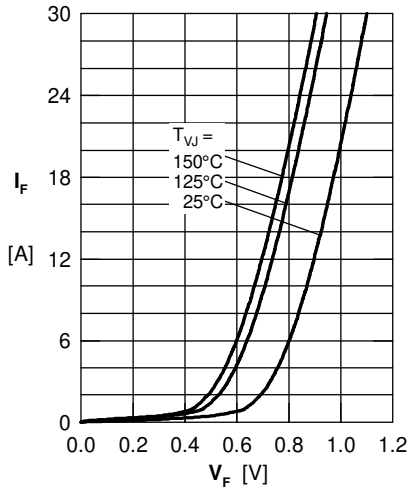

Fig. 1 Maximum forward voltage drop characteristics

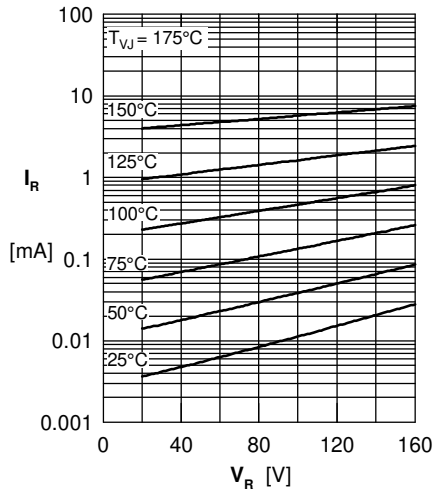

Fig. 2 Typ. reverse current I_R vs. reverse voltage V_R

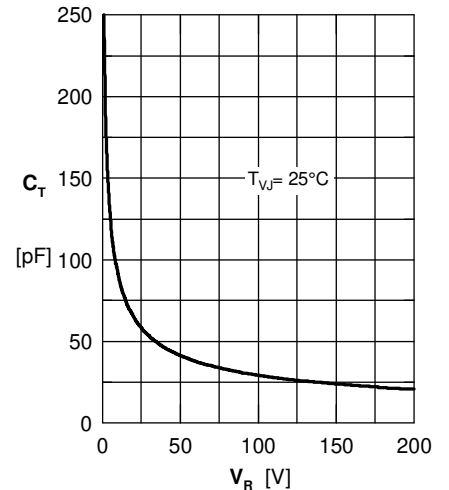

Fig. 3 Typ. junction capacitance C_T vs. reverse voltage V_R

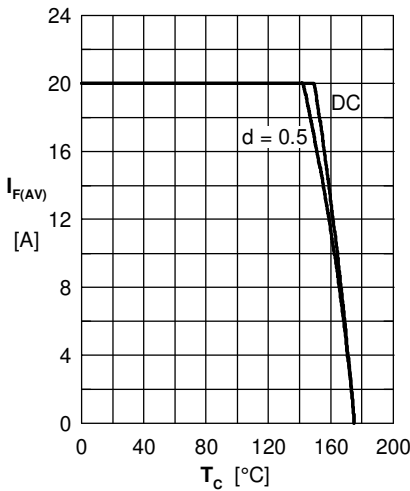

Fig. 4 Avg: forward current $I_{F(AV)}$ vs. case temperature T_C

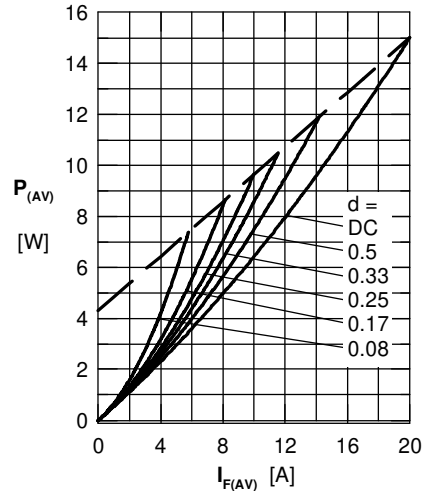

Fig. 5 Forward power loss characteristics

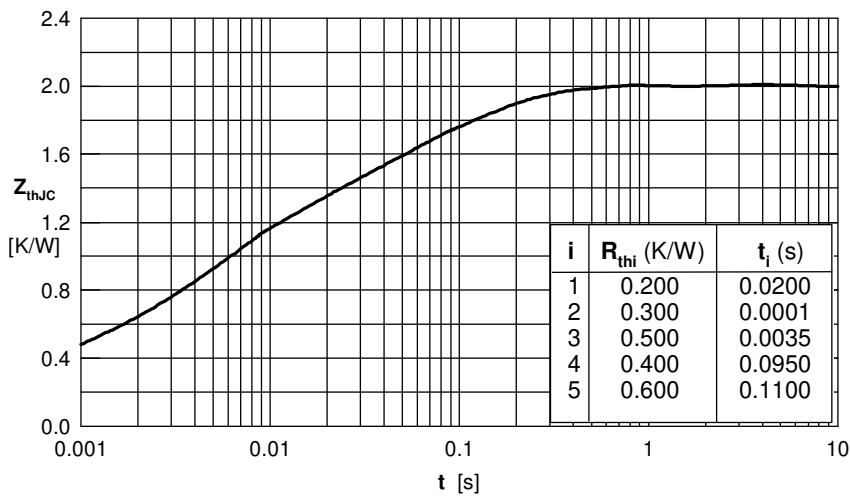

Fig. 6 Transient thermal impedance junction to case