

C1608CH2A120J080AA

TDK Item Description : C1608CH2A120JT***



Application & Main Feature

Commercial Grade (Mid Voltage (100 to 630V))

Series

C1608 [EIA CC0603]

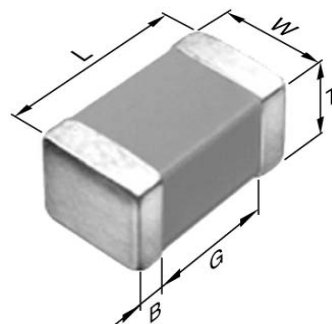

Dimensions

L 1.60mm +/-0.1mm
W 0.80mm +/-0.1mm
T 0.80mm +/-0.1mm
B 0.20mm Min.
G 0.30mm Min.

Temperature Characteristic

CH (-25 to 85 degC 0+/-60ppm/degC)

Rated Voltage

2A (100Vdc)

Capacitance

12pF

Capacitance Tolerance

J (+/-5%)

Q Factor

640 Min.

Insulation Resistance

10Gohm Min.

AEC-Q200

Not Applicable

|Z|, ESR vs. Freq. Characteristics

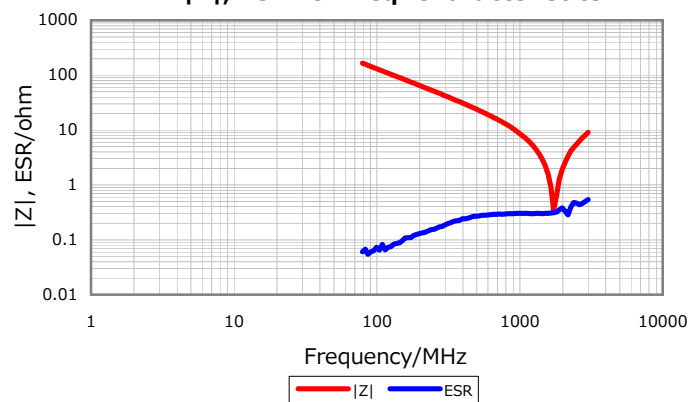

DC Bias Characteristic

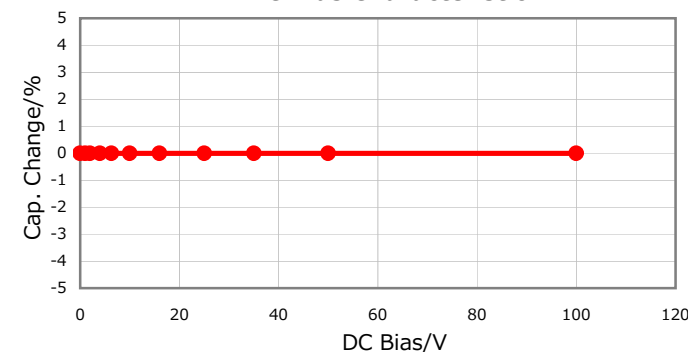

Cap. vs. Freq. Characteristic

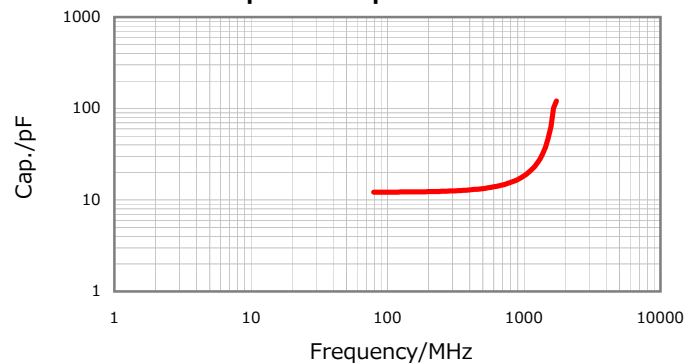

Temperature Characteristics

