

## General Specifications

### Electrical Capacity (Resistive Load)

**Power Level:** 1mA @ 5V DC (resistive load)

### Other Ratings

- XY Resistive Value:** 250 ~ 850Ω; Wide: 120 ~ 1,500Ω
- Linearity:** ±1.5% maximum
- Insulation Impedance:** 10MΩ minimum @ 25V DC
- Expected Operational Life:** Writing: 50,000 operations minimum (approximately 30mm movement with stylus)  
Tapping: 1,000,000 operations minimum (pressing force 4.9N using silicone rubber, hardness 60°)
- Touch Activation Force:** 1.47N maximum
- Chattering Time:** 10 milliseconds maximum
- Light Transmission:** 80% typical (Touch Panel portion)
- Surface Hardness:** 2H minimum (JIS K5600)

### Environmental Data

- Operating Temperature Range:** -20°C ~ +70°C (-4°F ~ +158°F)
- Storage Temperature Range:** -40°C ~ +80°C (-40°F ~ +176°F)
- Relative Humidity:** +60°C (+140°F), humidity 90%, 240 hours

### TYPICAL ORDERING EXAMPLE

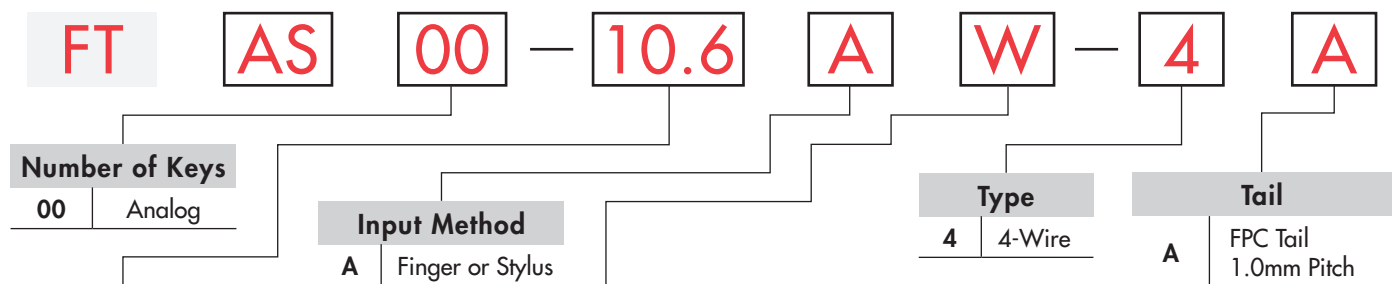

Number of Keys	
00	Analog

Screen Size	
5.7	5.7"
6.5	6.5"
8.4	8.4"
10.4	10.4"
10.6	10.6"
12.1	12.1"
15	15.0"
15.6	15.6"
19	19.0"

*Position of Tail (Analog)	
No Code	Left or Right (Horizontal)
V	Top or Bottom (Vertical)
S	Narrow Frame Type 1 (Horizontal)
N	Narrow Frame Type 2 (Horizontal)
W	Wide Type (Horizontal)







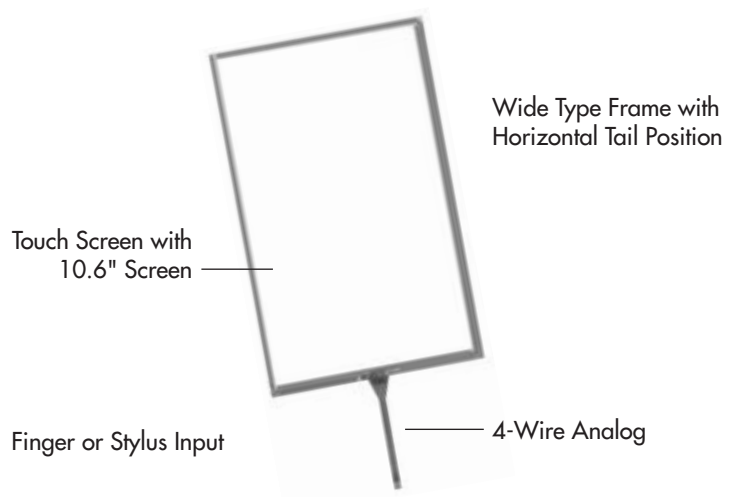



\* Aspect Ratio:  
Narrow Frame: 4:3  
Wide Frame: 16:9

### DESCRIPTION FOR TYPICAL ORDERING EXAMPLE

**FTAS00-10.6AW-4A**



## PART NUMBERS & DESCRIPTIONS

			
<b>FTAS00-5.7AS-4A</b>	<b>FTAS00-6.5AS-4A</b>	<b>FTAS00-8.4AS-4A</b>	<b>FTAS00-10.4AS-4A</b>
			
<b>FTAS00-10.4AV-4A</b>	<b>FTAS00-10.6AW-4A</b>	<b>FTAS00-12.1AN-4A</b>	<b>FTAS00-12.1AW-4A</b>
			
<b>FTAS00-15AN-4A</b>	<b>FTAS00-15.6AW-4A</b>	<b>FTAS00-19AN-4A</b>	

### 4-Wire Analog Touch Screens

Tail	Part Number	Screen Size in Inches	Key Area Dimensions	Viewing Area Dimensions	External Dimensions	Panel Thickness	Terminal Detail 4 Pin .039" (1.0mm) Pitch
Narrow Frame Type 1 Horizontal Tail	<b>FTAS00-5.7AS-4A</b>	5.7	4.535" x 3.402" (115.2mm x 86.4mm)	4.764" x 3.606" (121.0mm x 91.6mm)	5.157" x 3.976" (131.0mm x 101.0mm)	.055" (1.4mm)	Length 2.559" (65.0mm)
	<b>FTAS00-6.5AS-4A</b>	6.5	5.197" x 3.898" (132.0mm x 99.0mm)	5.433" x 4.134" (138.0mm x 105.0mm)	5.906" x 4.567" (150.0mm x 116.0mm)	.055" (1.4mm)	Length 2.559" (65.0mm)
	<b>FTAS00-8.4AS-4A</b>	8.4	6.728" x 5.102" (170.9mm x 129.6mm)	6.949" x 5.331" (176.5mm x 135.4mm)	7.343" x 5.685" (186.5mm x 144.4mm)	.083" (2.1mm)	Length 3.150" (80.0mm)
	<b>FTAS00-10.4AS-4A</b>	10.4	8.315" x 6.236" (211.2mm x 158.4mm)	8.465" x 6.394" (215.0mm x 162.4mm)	8.882" x 6.748" (225.6mm x 171.4mm)	.083" (2.1mm)	Length 3.150" (80.0mm)
Vertical Tail	<b>FTAS00-10.4AV-4A</b>	10.4	8.354" x 6.276" (212.2mm x 159.4mm)	8.520" x 6.433" (216.4mm x 163.4mm)	8.917" x 7.205" (226.5mm x 183.0mm)	.083" (2.1mm)	Length 3.150" (80.0mm)
Narrow Frame Type 2 Horizontal Tail	<b>FTAS00-12.1AN-4A</b>	12.1	9.677" x 7.256" (245.8mm x 184.3mm)	9.827" x 7.406" (249.6mm x 188.1mm)	10.236" x 7.795" (260.0mm x 198.0mm)	.083" (2.1mm)	Length 3.150" (80.0mm)
	<b>FTAS00-15AN-4A</b>	15.0	11.972" x 8.980" (304.1mm x 228.1mm)	12.130" x 9.138" (308.1mm x 232.1mm)	12.669" x 9.665" (321.8mm x 245.5mm)	.083" (2.1mm)	Length 3.150" (80.0mm)
	<b>FTAS00-19AN-4A</b>	19.0	14.815" x 11.850" (376.3mm x 301.0mm)	15.039" x 12.102" (382.0mm x 307.4mm)	15.571" x 12.638" (395.5mm x 321.0mm)	.083" (2.1mm)	Length 3.150" (80.0mm)
Wide Type Horizontal Tail	<b>FTAS00-10.6AW-4A</b>	10.6	9.071" x 5.441" (230.4mm x 138.2mm)	9.189" x 5.563" (233.4mm x 141.3mm)	9.756" x 6.094" (247.8mm x 154.8mm)	.083" (2.1mm)	Length 3.150" (80.0mm)
	<b>FTAS00-12.1AW-4A</b>	12.1	10.280" x 6.425" (261.12mm x 163.2mm)	10.404" x 6.551" (264.26mm x 166.4mm)	10.827" x 6.929" (275.0mm x 176.0mm)	.083" (2.1mm)	Length 3.150" (80.0mm)
	<b>FTAS00-15.6AW-4A</b>	15.6	13.551" x 7.618" (344.2mm x 193.5mm)	13.681" x 7.748" (347.5mm x 196.8mm)	14.276" x 8.433" (362.6mm x 214.2mm)	.083" (2.1mm)	Length 3.150" (80.0mm)

Toggles  
Rocker  
Pushbuttons  
Illuminated PB  
Programmable  
Keylocks  
Rotaries  
Slides  
Tactiles  
Tilt  
Touch  
Indicators  
Accessories  
Supplement

## TYPICAL DIMENSIONS

### Vertical Tail

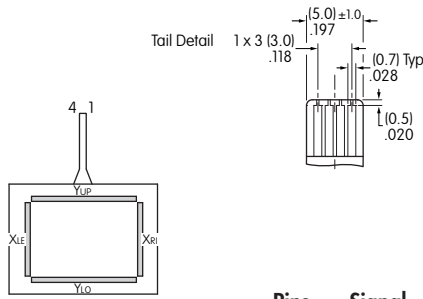

Y<sub>UP</sub>, Y<sub>LO</sub>: Bottom Electrode Terminal  
X<sub>LE</sub>, X<sub>RI</sub>: Top Electrode Terminal

Pins	Signal
1	Y <sub>UP</sub>
2	Y <sub>LO</sub>
3	X <sub>LE</sub>
4	X <sub>RI</sub>

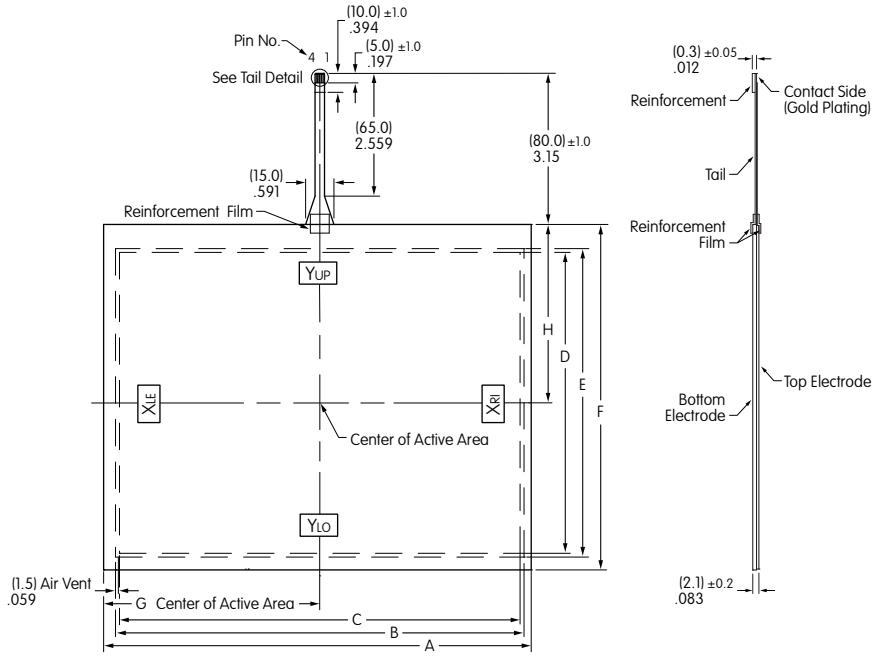

Typical Dimensions for Vertical Frame

Part Number	Screen Size in Inches	Dim A	Dim B Viewable Area	Dim C Active Area	Dim D Active Area	Dim E Viewable Area	Dim F	Dim G Center of Active Area (Horizontal)	Dim H Center of Active Area (Vertical)
<b>FTAS00-10.4AV-4A</b>	10.4	8.917" (226.5±0.3mm)	8.520" (216.4mm)	8.354" (212.2mm)	6.276" (159.4mm)	6.433" (163.4mm)	7.205" (183.0±0.3mm)	4.508" (114.5mm)	3.720" (94.5mm)

## TYPICAL DIMENSIONS

### Horizontal Tail & Wide Frame

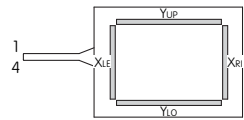

Y<sub>UP</sub>, Y<sub>LO</sub>: Bottom Electrode Terminal  
X<sub>LE</sub>, X<sub>RI</sub>: Top Electrode Terminal

Pins	Signal
1	Y <sub>UP</sub>
2	Y <sub>LO</sub>
3	X <sub>LE</sub>
4	X <sub>RI</sub>

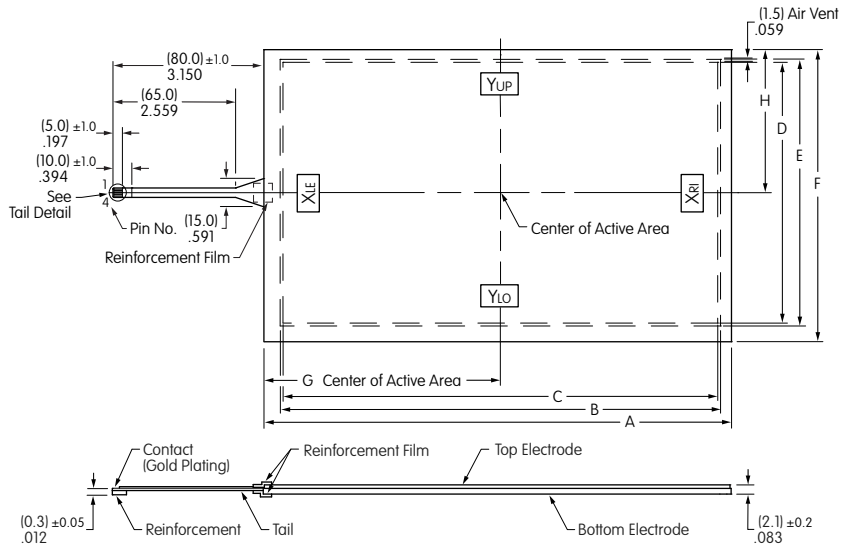

Typical Dimensions for Wide Horizontal Frames

Part Number	Screen Size in Inches	Dim A	Dim B Viewable Area	Dim C Active Area	Dim D Active Area	Dim E Viewable Area	Dim F	Dim G Center of Active Area (Horizontal)	Dim H Center of Active Area (Vertical)
<b>FTAS00-10.6AW-4A</b>	10.6	9.756" (247.8±0.3mm)	9.189" (233.4mm)	9.071" (230.4mm)	5.441" (138.2mm)	5.563" (141.3mm)	6.095" (154.8±0.3mm)	4.933" (125.3mm)	2.984" (75.8mm)
<b>FTAS0012.1AW-4A</b>	12.1	10.827" (275.0±0.3mm)	10.404" (264.26mm)	10.280" (261.12mm)	6.425" (163.2mm)	6.551" (166.4mm)	6.929" (176.0±0.3mm)	5.468" (138.89mm)	3.465" (88.0mm)
<b>FTAS0015.6AW-4A</b>	15.6	14.276" (362.6±0.3mm)	13.681" (347.5mm)	13.551" (344.2mm)	7.618" (193.5mm)	7.748" (196.8mm)	8.433" (214.2±0.3mm)	7.138" (181.3mm)	4.217" (107.1mm)

## TYPICAL DIMENSIONS

### Horizontal Tail & Narrow Frame

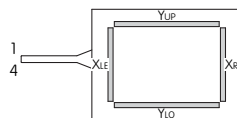
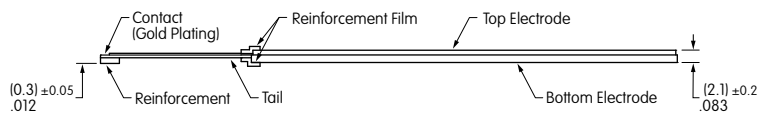
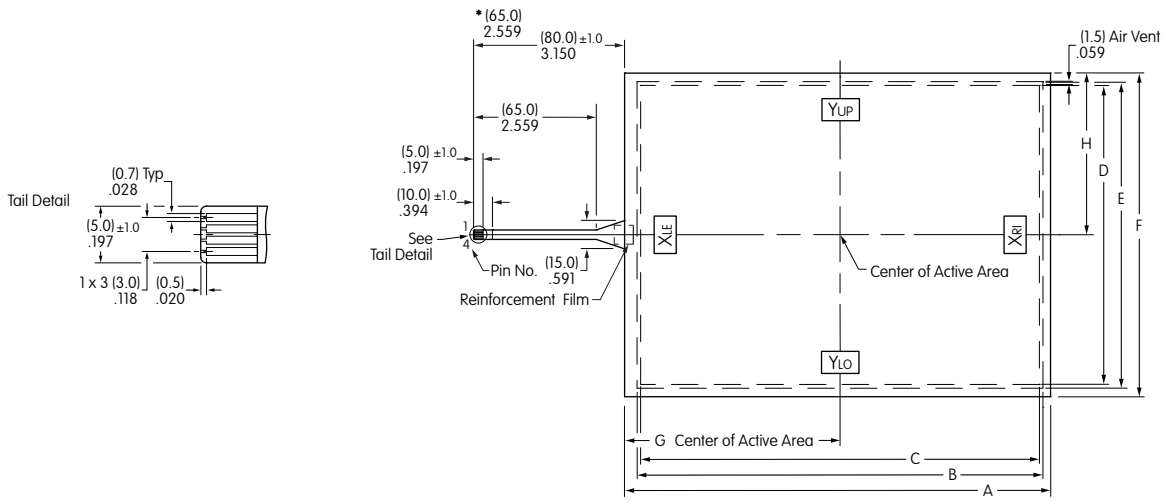

YUP, YLO: Bottom Electrode Terminal  
XLE, XRI: Top Electrode Terminal

**Pins Signal**

Pins	Signal
1	Y <sub>UP</sub>
2	Y <sub>LO</sub>
3	X <sub>LE</sub>
4	X <sub>RI</sub>

### Typical Dimensions for Narrow Frames

Part Number	Screen Size in Inches	Dim A	Dim B Viewable Area	Dim C Active Area	Dim D Active Area	Dim E Viewable Area	Dim F	Dim G Center of Active Area (Horizontal)	Dim H Center of Active Area (Vertical)
* FTAS00-5.7AS-4A	5.7	5.157" (131.0±0.3mm)	4.764" (121.0mm)	4.535" (115.2mm)	3.402" (86.4mm)	3.606" (91.6mm)	3.976" (101.0±0.3mm)	2.648" (67.25mm)	1.988" (50.5mm)
* FTAS00-6.5AS-4A	6.5	5.906" (150.0±0.3mm)	5.433" (138.0mm)	5.197" (132.0mm)	3.898" (99.0mm)	4.134" (105.0mm)	4.567" (116.0±0.3mm)	3.031" (77.0mm)	2.284" (58.0mm)
FTAS00-8.4AS-4A	8.4	7.343" (186.5±0.3mm)	6.949" (176.5mm)	6.728" (170.9mm)	5.102" (129.6mm)	5.331" (135.4mm)	5.685" (144.4±0.3mm)	3.734" (94.85mm)	2.843" (72.2mm)
FTAS00-10.4AS-4A	10.4	8.882" (225.6±0.3mm)	8.465" (215.0mm)	8.315" (211.2mm)	6.236" (158.4mm)	6.394" (162.4mm)	6.748" (171.4±0.3mm)	4.492" (114.1mm)	3.374" (85.7mm)
FTAS00-12.1AN-4A	12.1	10.236" (260.0±0.3mm)	9.827" (249.6mm)	9.677" (245.8mm)	7.256" (184.3mm)	7.406" (188.1mm)	7.795" (198.0±0.3mm)	5.177" (131.5mm)	3.850" (97.8mm)
FTAS00-15AN-4A	15.0	12.669" (321.8±0.3mm)	12.130" (308.1mm)	11.972" (304.1mm)	8.980" (228.1mm)	9.138" (232.1mm)	9.665" (245.5±0.3mm)	6.398" (162.5mm)	4.833" (122.75mm)
FTAS00-19AN-4A	19.0	15.571" (395.5±0.3mm)	15.039" (382.0mm)	14.815" (376.3mm)	11.850" (301.0mm)	12.102" (307.4mm)	12.638" (321.0±0.3mm)	7.799" (198.1mm)	6.319" (160.5mm)

Toggles  
Rockers  
Pushbuttons  
Illuminated PB  
Programmable  
Keylocks  
Rotaries  
Slides  
Tactiles  
Tilt  
Touch  
Indicators  
Accessories  
Supplement

Toggles

Rockers

Pushbuttons

Illuminated PB

Programmable

Keylocks

Rotaries

Slides

Tactiles

Tilt

Touch

Indicators

Accessories

Supplement

## Controller Board for RS232C

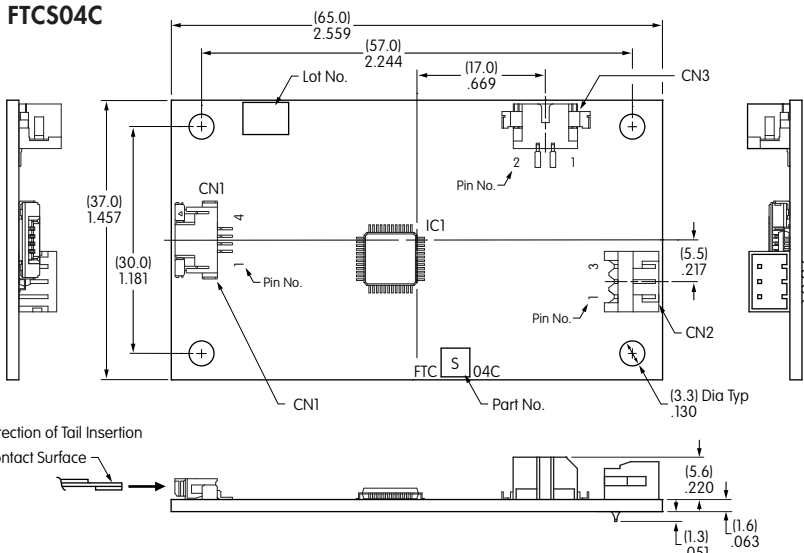

### CN1 4-Wire Analog Touch Screen Connector - 4 Pins

Pin No.	Symbol	Description
1	Y0	For YUP or YLO
2	Y1	
3	X0	For XRI or XLE
4	X1	

### CN2 RS232C Header Connector - 3 Pins

Controller Board Side			
Pin No.	Symbol	Description	Computer Side
1	RD	Receiving Data (IN)	Sending Data
2	SD	Sending Data (OUT)	Receiving Data
3	GND	GND	GND

### CN3 Header Connector for Power Supply - 2 Pins

Pin No.	Symbol	Description
1	V <sub>CC</sub>	Supply Voltage
2	GND	GND

## Controller Board for USB

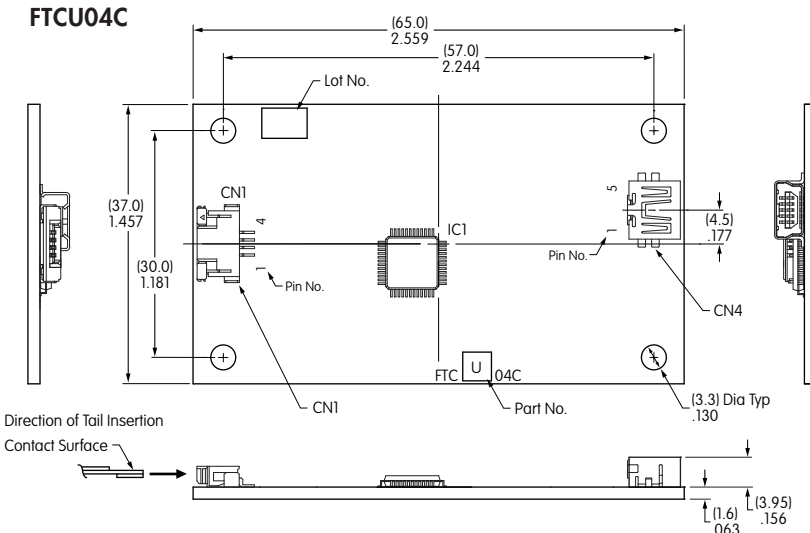

### CN1 4-Wire Analog Touch Screen Connector - 4 Pins

Pin No.	Symbol	Description
1	Y0	For YUP or YLO
2	Y1	
3	X0	For XRI or XLE
4	X1	

### CN4 Header Connector for USB - 5 Pins

Pin No.	Symbol	Description
1	V <sub>CC</sub>	USB V <sub>CC</sub>
2	D-	USB D-
3	D+	USB D+
4	GND	USB GND
5	GND	Shield GND

## Controller Boards & Drivers

### DISTINCTIVE CHARACTERISTICS

- Compatible with Control Board USB/RS232C
- Equipped with EPROM for Saving Setting Data
- Device Drivers are Windows 7, 8 & 10 Compatible

Controller Boards		
Type	Part No.	Communication Protocol
4-Wire	<b>FTCS04C</b>	RS232C
4-Wire	<b>FTCU04C</b>	USB

### System Configuration for USB

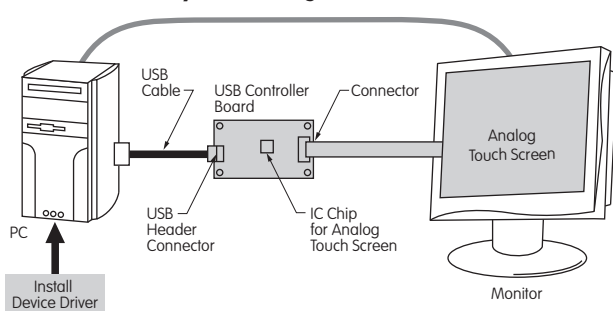

### System Configuration for RS232C

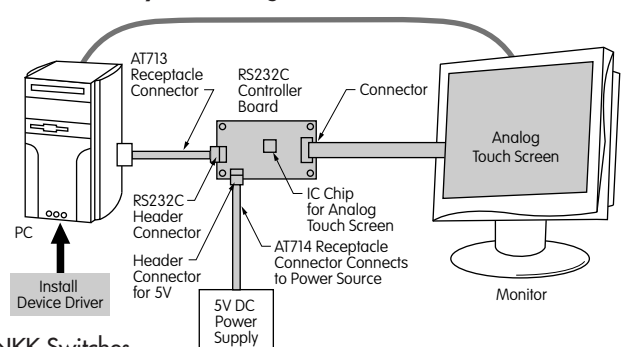

Available through NKK Switches

## 4-Wire Touch Screens with FPC Tails

General Specifications		
Items	FTCS04C	FTCU04C
Interface	RS232C	USB 2.0 Full Speed
Clock	16MHz	16MHz
Supply Voltage	5.0V	5.0V (Bus Power)
Resolution	10bit	10bit
Current Consumption	40mA maximum	100mA maximum
Communication Speed	9600 bps	—
Communication Format	Data Length: 8bit Parity: None Stop Bit: 1	—

Touch panels can be operated the same as PC mouse functions by combining a control board or device driver and analog touch screen.

The controller board is designed specifically for touch screens with the FPC tails. Refer to the product data sheet for detailed specifications, available by contacting NKK Switches.

### Absolute Maximum Ratings

Items	Symbols	Minimum	Maximum	Notes
Supply Voltage	V <sub>CC</sub>	-0.3V	+5.5V	—
Input Voltage	V <sub>TP</sub>	—	V <sub>CC</sub>	Touch Panel Input
	*V <sub>RS</sub>	-15V	+15V	RS232C
Operating Temperature	T <sub>OPR</sub>	-20°C -4°F	+70°C +158°F	—
Storage Temperature	T <sub>STG</sub>	-25°C -13°F	+85°C +185°F	—

\*V<sub>RS</sub>: Applies Only to RS232C

### Recommended Values

Items	Symbols	Minimum	Typical	Maximum	Notes
Supply Voltage	V <sub>CC</sub>	+4.75V	+5.0	+5.25V	—
Operating Temperature	T <sub>OPR</sub>	-20°C -4°F	—	+70°C +158°F	No Condensation

## IC Chip & Accessories

### DISTINCTIVE CHARACTERISTICS

- Interface: USB and RS232C
- High Speed and Accuracy
- Built-in Calibration Function
- Data Function Removal Built In to Eliminate Noise



IC FTCSU548

The IC is for use with the 4-wire transparent touch screens. When the screen is touched, it recognizes the position of the touch by the level of analog voltage detected by the A/D. The A/D converter receives the value and sends a set of coordinate values as serial data or USB.

### General Specifications for IC FTCSU548

Package	LFQFP 48 Pins
Interface	Serial Interface (Asynchronous) or USB (Full Speed 2.0)
Supply Voltage	3.3/5.0V Typ; USB Available for 5V Only
* Rated Output Current	High Level: -170mA Low Level: +170mA
Operation Frequency	16MHz
A/D Converter Resolution	10bit
Operating Temperature	-20°C ~ +85°C (-4°F ~ +185°F)
Storage Temperature	-40°C ~ +125°C (-40°F ~ +257°F)

\* Total Output Electric Current Amount of all the I/O Port

Contact NKK Switches for the IC data sheet.

### OPTIONAL ACCESSORIES

#### Receptacle Connector & Wire Assembly for RS232C

AT713 is the Receptacle Connector with code to connect to RS232C communication of the controller boards. It is compatible with FTCS04C. The cable length is adjustable.

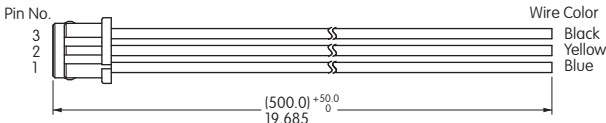

#### Receptacle Connector & Wire Assembly for Power Supply

AT714 is a Receptacle Connector with code to connect to FTCS04C power source of the control boards. The cable length is adjustable.

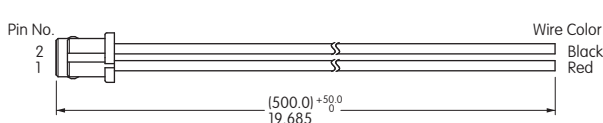

## STORAGE, HANDLING & INSTALLATION

### Handling of Controller Board

- Use arc prevention to protect device from static electricity.
- Power source should be activated after host and touch panel are connected.
- When inserting connector CN1 and touch panel tail, be sure the slider of connector CN1 is pulled. Do not pull more than 10 times.
- Do not alter the product.
- Do not use any commands other than the ones outlined in the specifications.
- Place the product away from noise source (such as inverter from LCD operation) since tail can be affected by noise.
- If device driver (USB) does not work after installation, reboot the host computer while connected to the controller board.
- This product does not support suspended mode (USB).
- Protocol of USB transmission is one frame per one transaction.
- Contact factory if not using the protocol above.
- Warranty for one year after delivery. NKK warranties the 4-wire touch panel when it is used with the NKK control board and driver. Do not use third party control boards. NKK is not responsible for results of using damaged equipment with the controller boards.
- NKK Switches cannot assume responsibility for damages caused by software side during use of the touch screens.
- The touch screen pressed position may shift depending on various factors such as age, improper tail insertion or extreme temperatures. In such cases, recalibration is necessary.

### Installation

- Products are ESD sensitive and ESD protection is required.
- Do not pull on the tail. Do not apply stress to the tail area.
- Avoid vibration or shock. Avoid any force or stress that may cause deformation to the product.
- The touch screen mounting should not be loose. This may cause an adverse effect on detecting performance during operation.
- Ensure there are no burrs around the edges of the case or housing that can cause false actuation. The edges of the case or housing should not enter the keying area.
- The case or housing and upper electrode should have a space of about 0.5mm to accommodate expansion or shrinkage due to temperature variances. If a shock barrier is used, do not press hard on the upper electrode area. Any shock barrier should be installed more than 0.6mm away from A.

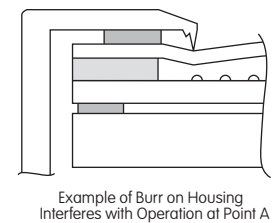
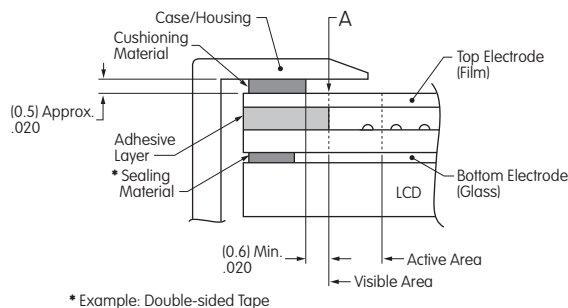

- To secure the touch screen, secure the lower portion with a device such as the LCD display panel. Do not attach the upper electrode with double-sided tape or similar product to avoid stress that can damage the upper or lower electrode.
- In order to balance upper and lower pressure, an air vent may be installed. Ensure that no liquid or oil will enter into the device.
- Avoid air pressure applied to the touch screen as it may cause the top electrode to force air through the air vent, effecting electric endurance. If pressure inside of the touch panel is reduced through the air vent, it may cause interference fringes or may remain in ON status.
- Ensure that the glass is handled carefully to prevent breakage during installation.
- Moisture from condensation on tail connection or edges may result in migration, causing short circuit failure.
- Remove protective film from the touch screen after installation is completed.

## STORAGE, HANDLING &amp; INSTALLATION

**Handling Precautions**

- When opening product, take precaution with up/down and front/back directions. Glass edges are not chamfered, and corners or edges can be sharp. Wear gloves when handling the product.
- Do not pick up the product by the tail or pull the tail area.
- Use gloves or finger cots to prevent fingerprints on surface.
- When handling the product, hold it outside of the viewing area.
- Avoid stacking multiple products or placing other items on the product.
- When packing or storing, the glass should be positioned face up.

**Operating Precautions**

- Operate with fingers or a touch screen stylus only.
- Do not press hard with a pen or similar object between viewing area and key area.

**Design Precautions**

- With analog type, resistive value change (by aging or individual differences) can dislocate the input area. Input area can be calibrated with software.
- When installing on top of an LCD, noise from the display device can create misoperation. To avoid noise, implement grounding the display device frame.
- Do not create software for simultaneous touch points, as analog type will read the center point between two touch points.
- When used to draw a line, analog type will have a break at dot spacer. Compensate for this with software.
- Contact resistance may cause chatter depending on pressing condition. Software should detect signal after it stabilizes.

**Other Precautions**

- Clean with a soft cloth and ethanol. Do not use any cleaning agents other than ethanol.
- Store product in original package and store at the temperature and humidity range specified.
- Do not store in an environment with acids or other corrosive gases or where condensation may occur.
- Products are guaranteed based on evaluation of standards within the moisture tolerance and usage temperature range, but not guaranteed to operate perpetually at this temperature.
- Note that an incorrect type of connector may damage the print surface.
- Calibration data from one touch panel should not be applied to another panel; each should be calibrated individually.
- Recalibration is necessary if connector has been removed from the tail and reconnected.
- All specifications based on the tested touch screens only. Evaluate the products after installation with customer's equipment.
- NKK Switches reserves the right to make product improvement changes without notice.