

Feed-through plug - DFK-PC 5/ 9-STF-7,62 - 1716687

Please be informed that the data shown in this PDF Document is generated from our Online Catalog. Please find the complete data in the user's documentation. Our General Terms of Use for Downloads are valid (<http://phoenixcontact.com/download>)



Feed-through connector, nominal current: 41 A, number of positions: 9, pitch: 7.62 mm, connection method: Screw connection with tension sleeve, color: green, contact surface: Tin

Your advantages

- ✓ Well-known connection principle allows worldwide use
- ✓ Low temperature rise, thanks to maximum contact force
- ✓ Allows connection of two conductors
- ✓ Flange system enables secure fixing to the housing panel by means of tool-free snap-in locking or screws
- ✓ Shroud for professional EMC shield connection on the front of the device
- ✓ Screwable flange for superior mechanical stability

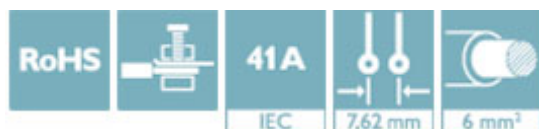

Key Commercial Data

Packing unit	10 pc
GTIN	 4 046356 137300
GTIN	4046356137300

Technical data

Dimensions

Length [l]	48.95 mm
Width [w]	103.2 mm
Height [h]	26.24 mm
Pitch	7.62 mm
Dimension a	60.96 mm

General

Range of articles	DFK-PC 5/...-STF
Number of positions	9
Connection method	Screw connection with tension sleeve
Insulating material group	I

Feed-through plug - DFK-PC 5/ 9-STF-7,62 - 1716687

Technical data

General

Rated surge voltage (III/3)	8 kV
Rated surge voltage (III/2)	8 kV
Rated surge voltage (II/2)	6 kV
Rated voltage (III/3)	630 V
Rated voltage (III/2)	1000 V
Rated voltage (II/2)	1000 V
Connection in acc. with standard	EN-VDE
Nominal current I_N	41 A
Nominal cross section	6 mm ²
Maximum load current	41 A
Insulating material	PA
Flammability rating according to UL 94	V0
Stripping length	10 mm
Screw thread	M3
Tightening torque, min	0.7 Nm
Tightening torque max	0.8 Nm

Connection data

Conductor cross section solid min.	0.2 mm ²
Conductor cross section solid max.	10 mm ²
Conductor cross section flexible min.	0.2 mm ²
Conductor cross section flexible max.	6 mm ²
Conductor cross section flexible, with ferrule without plastic sleeve min.	0.25 mm ²
Conductor cross section flexible, with ferrule without plastic sleeve max.	6 mm ²
Conductor cross section flexible, with ferrule with plastic sleeve min.	0.25 mm ²
Conductor cross section flexible, with ferrule with plastic sleeve max.	4 mm ²
Conductor cross section AWG min.	24
Conductor cross section AWG max.	10
2 conductors with same cross section, solid min.	0.2 mm ²
2 conductors with same cross section, solid max.	2.5 mm ²
2 conductors with same cross section, stranded min.	0.2 mm ²
2 conductors with same cross section, stranded max.	4 mm ²
2 conductors with same cross section, stranded, ferrules without plastic sleeve, min.	0.25 mm ²
2 conductors with same cross section, stranded, ferrules without plastic sleeve, max.	1.5 mm ²
2 conductors with same cross section, stranded, TWIN ferrules with plastic sleeve, min.	0.25 mm ²
2 conductors with same cross section, stranded, TWIN ferrules with plastic sleeve, max.	2.5 mm ²
Minimum AWG according to UL/CUL	24
Maximum AWG according to UL/CUL	8

Feed-through plug - DFK-PC 5/ 9-STF-7,62 - 1716687

Technical data

Standards and Regulations

Connection in acc. with standard	EN-VDE
	CUL
Flammability rating according to UL 94	V0

Environmental Product Compliance

	Lead 7439-92-1
China RoHS	Environmentally Friendly Use Period = 50
	For details about hazardous substances go to tab "Downloads", Category "Manufacturer's declaration"

Drawings

Diagram

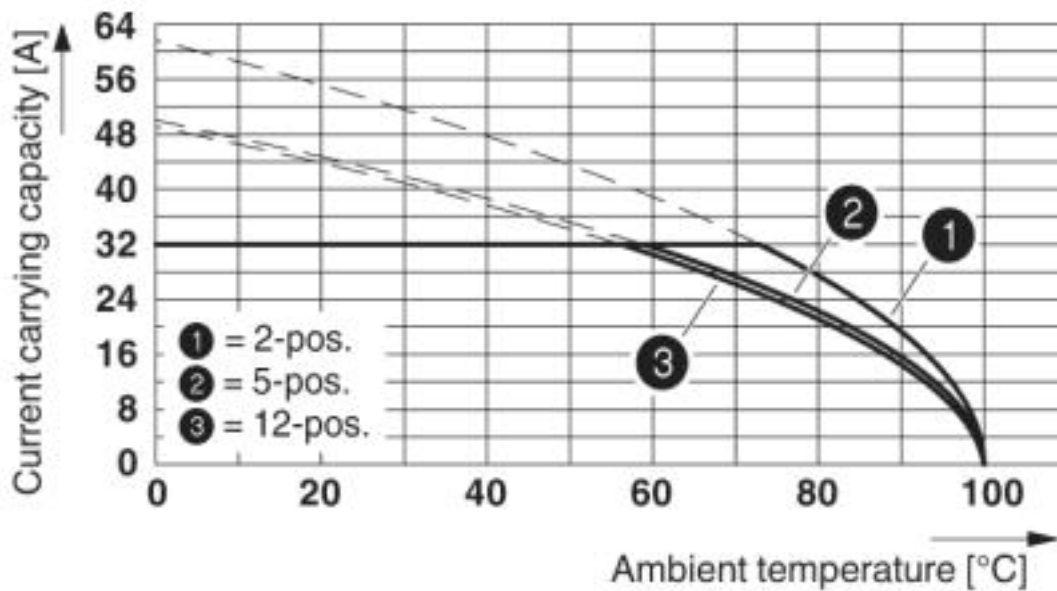

Derating curve for: DFK-PC 5/...-ST-7,62 with PC 5/...-ST-7,62
 Conductor cross section = 6 mm²

Feed-through plug - DFK-PC 5/ 9-STF-7,62 - 1716687

Diagram

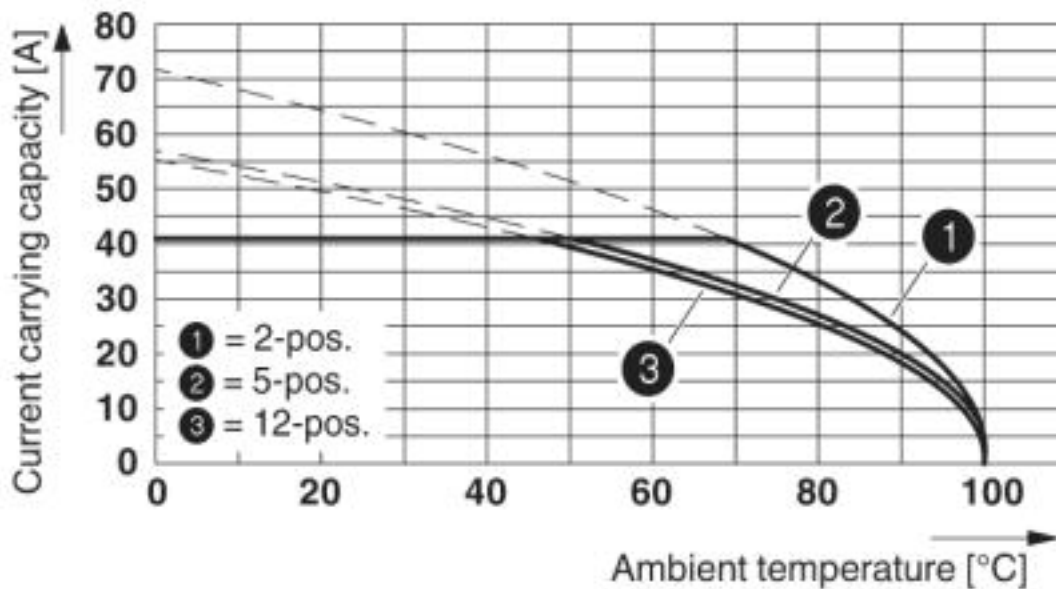

Derating curve for: DFK-PC 5/...-ST-7,62 with PC 5/...-ST-7,62
 Conductor cross section = 10 mm²

Diagram

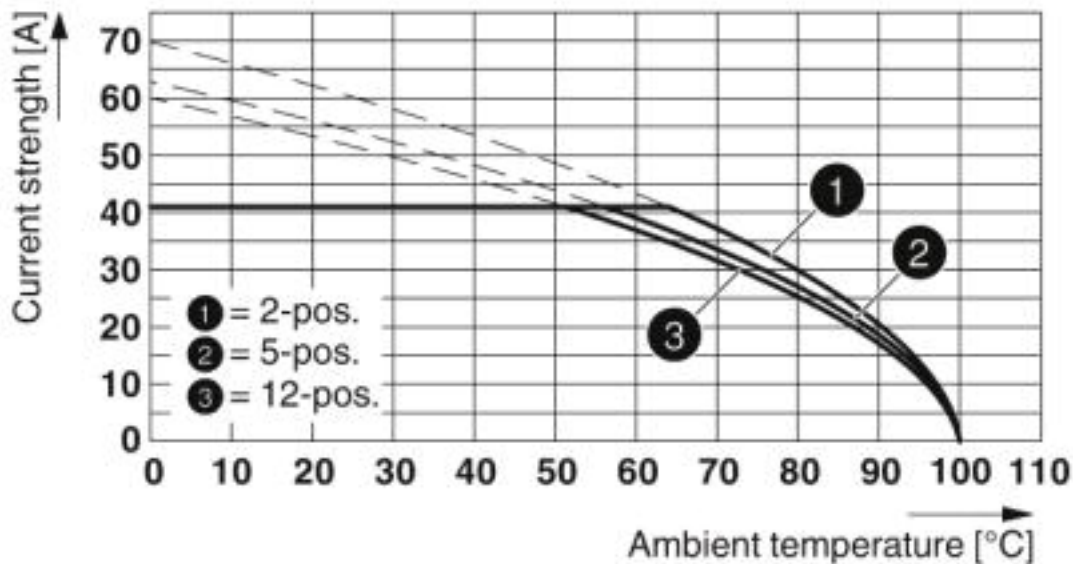

Type: SPC 5/...-STF-7,62 with DFK-PC 5/...-STF-7,62
 Conductor cross section: 10 mm²

Feed-through plug - DFK-PC 5/ 9-STF-7,62 - 1716687

Dimensional drawing

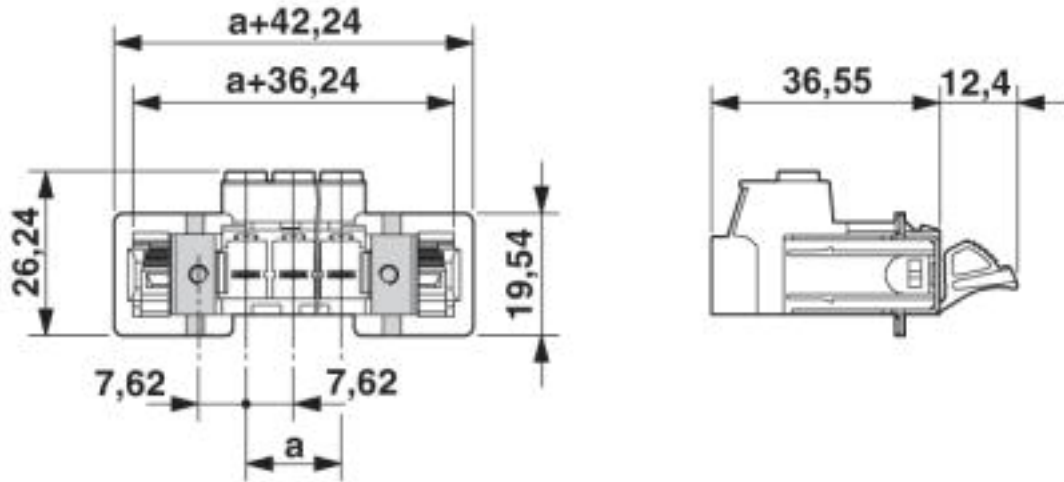

Dimensional drawing

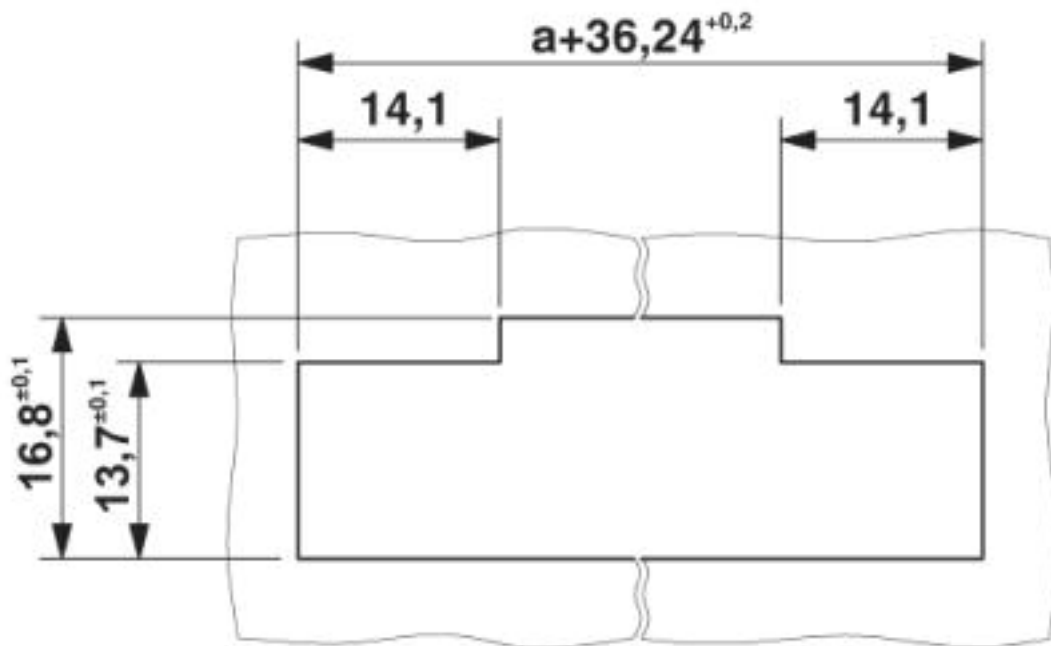

Sheet metal cutout for snap-on.

Feed-through plug - DFK-PC 5/ 9-STF-7,62 - 1716687

Dimensional drawing

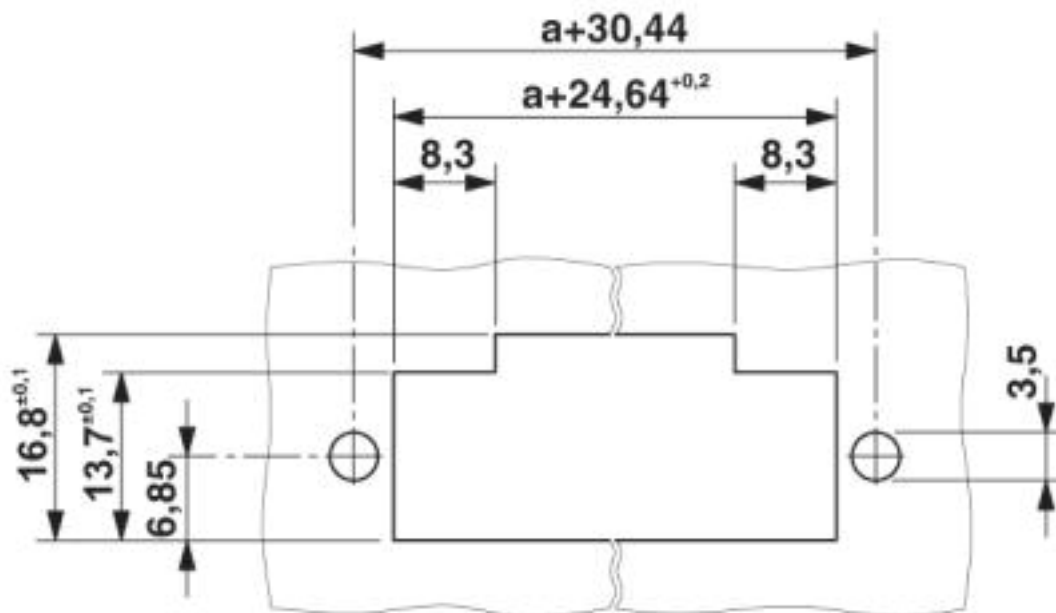

Sheet metal cutout for screw connection.

Approvals

Approvals

Approvals

EAC / cULus Recognized

Ex Approvals

Approval details

EAC		B.01742
-----	--	---------

cULus Recognized		http://database.ul.com/cgi-bin/XYV/template/LISEXT/1FRAME/index.htm	E60425-19920722
	B	C	
Nominal voltage UN	600 V	600 V	
Nominal current IN	41 A	41 A	
mm ² /AWG/kcmil	24-8	24-8	

Phoenix Contact 2019 © - all rights reserved
<http://www.phoenixcontact.com>

PHOENIX CONTACT GmbH & Co. KG
Flachsmarktstr. 8
32825 Blomberg
Germany
Tel. +49 5235 300
Fax +49 5235 3 41200
<http://www.phoenixcontact.com>