

PCB layout
view component side
thickness 1,6

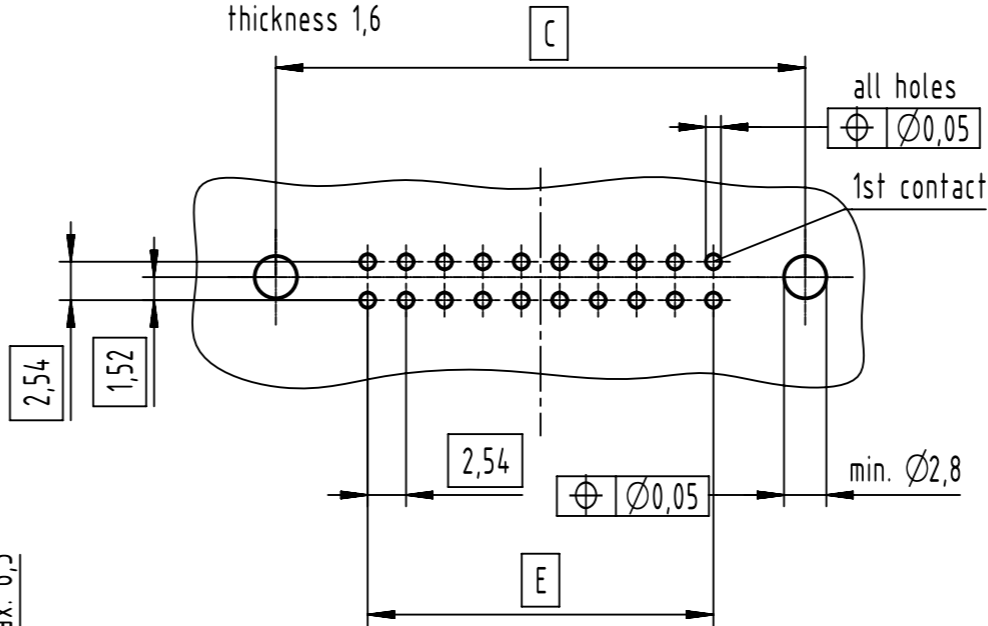

further information see
product data sheet

full range of P/N's and
dimensions shown on page 2/2

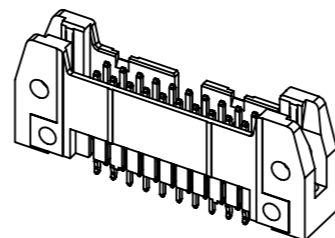

1st contact
see table for coding,
feature arrangement and style

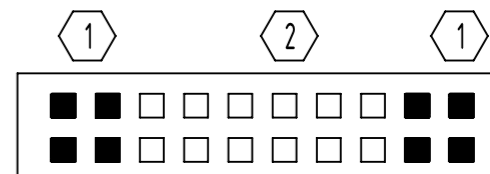

□ = straight contact
■ = kinked contact

1 kinked contacts

PCB thickness from 1,50 to 1,94 mm after Cu+Sn plating
with non remelted plated through holes Ø0,85 mm to Ø1,05 mm
max. insertion force = 125N
min. retention force = 3N

2 non kinked contacts

solder contacts for PCB connections
Ø1±0,1 acc. to IEC 60603-13

coding style table

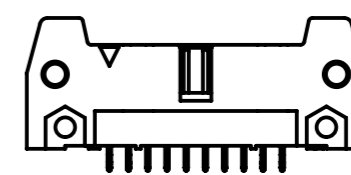

style A:
for connectors 6-pole

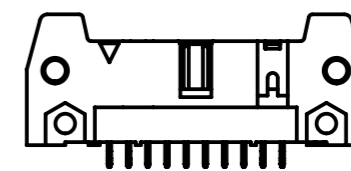

style B:
for connectors
from 10 to 14-pole

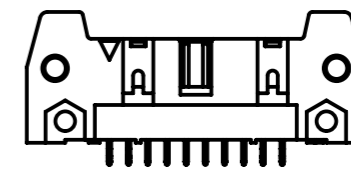

style C:
for connectors
from 16 to 64-pole

locking levers have to be ordered separately
- long locking lever: 09180009903
- short locking lever: 09180009904



All Dimensions in mm Original Size DIN A3		Scale 2:1	Free size tol. IEC 60603-13	Ref.	
All rights reserved Department EL PD		Created by STORCK	Inspected by LEHNERT	Standardisation 302077	Date 2021-02-02
HARTING D-32339 Espelkamp		Title SEK 18/19 male STD straight kinked w/o lever 2.9		State Final Release	
		Type TB	Number 091X5XXX024	Doc-Key / ECM-Nr. 100154464/UGD/044/C 500000163153	Rev. C
				Page 1/2	

no. of contacts	performance level	solder process	insulator colour	dimensions			
	PL2			A max.	C	D	E
06	09 18 506 6024	wave soldering	grey	27,2	22,86	12,45	2,54 x 2 = 5,08
10	09 18 510 6024			32,3	27,94	17,53	2,54 x 4 = 10,16
14	09 18 514 6024			37,4	33,02	22,61	2,54 x 6 = 15,24
16	09 18 516 6024			39,9	35,56	25,15	2,54 x 7 = 17,78
20	09 18 520 6024			45,0	40,64	30,23	2,54 x 9 = 22,86
24	09 18 524 6024			50,1	45,72	35,91	2,54 x 11 = 27,94
26	09 18 526 6024			52,6	48,26	37,85	2,54 x 12 = 30,48
30	09 18 530 6024			58,0	53,34	43,83	2,54 x 14 = 35,56
34	09 18 534 6024			62,8	58,42	48,01	2,54 x 16 = 40,64
40	09 18 540 6024			70,4	66,04	55,63	2,54 x 19 = 48,26
50	09 18 550 6024			83,1	78,74	68,33	2,54 x 24 = 60,96
60	09 18 560 6024			95,8	91,44	81,03	2,54 x 29 = 73,66
64	09 18 564 6024			100,9	96,52	86,11	2,54 x 31 = 78,74
06	09 19 506 6024			wave & reflow soldering	beige	27,2	22,86
10	09 19 510 6024	32,3	27,94			17,53	2,54 x 4 = 10,16
14	09 19 514 6024	37,4	33,02			22,61	2,54 x 6 = 15,24
16	09 19 516 6024	39,9	35,56			25,15	2,54 x 7 = 17,78
20	09 19 520 6024	45,0	40,64			30,23	2,54 x 9 = 22,86
24	09 19 524 6024	50,1	45,72			35,91	2,54 x 11 = 27,94
26	09 19 526 6024	52,6	48,26			37,85	2,54 x 12 = 30,48
30	09 19 530 6024	58,0	53,34			43,83	2,54 x 14 = 35,56
34	09 19 534 6024	62,8	58,42			48,01	2,54 x 16 = 40,64
40	09 19 540 6024	70,4	66,04			55,63	2,54 x 19 = 48,26
50	09 19 550 6024	83,1	78,74			68,33	2,54 x 24 = 60,96
60	09 19 560 6024	95,8	91,44			81,03	2,54 x 29 = 73,66
64	09 19 564 6024	100,9	96,52			86,11	2,54 x 31 = 78,74

	All Dimensions in mm Original Size DIN A3	Scale 1:1	Free size tol.	Ref.
	All rights reserved Department EL PD	Created by STORCK	Inspected by LEHNERT	Standardisation 302077
HARTING D-32339 Espelkamp	Title SEK 18/19 male STD straight kinked w/o lever 2.9			Doc-Key / ECM-Nr. 100154464/UGD/044/C 500000163153
	Type TB	Number 091X5XXX024	Rev. C	Page 2/2