

Schematic for the NCP160FCT2GEVB Evaluation Board

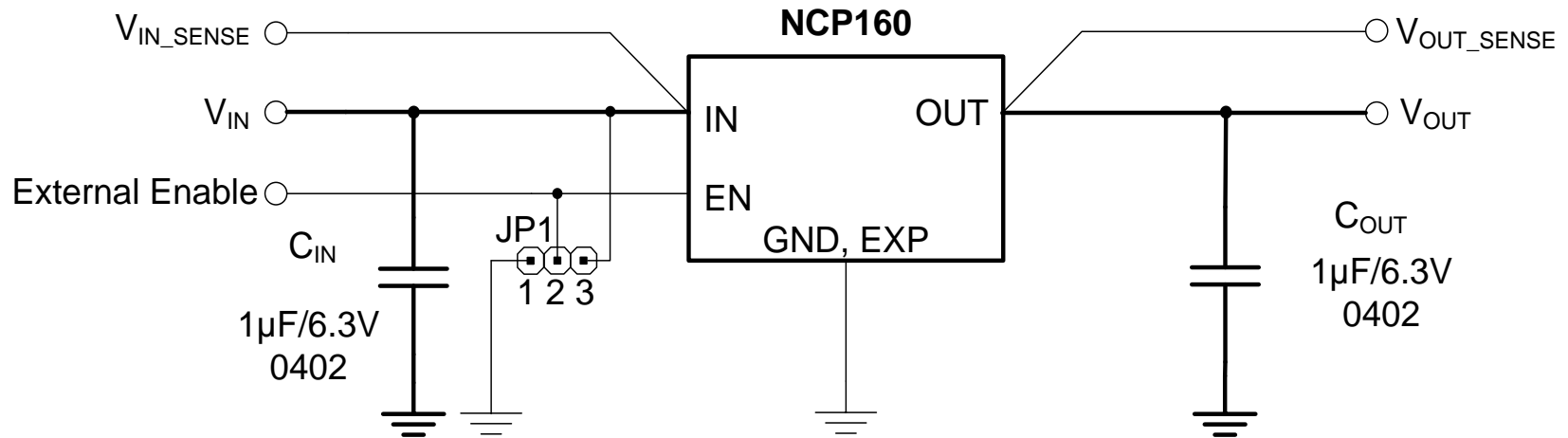

The NCP160 is 250mA high performance LDO with low quiescent current (23µA max.) and very high PSRR. The NCP160 also offers excellent load/line transients and ultra-low noise.

JP1 positions:

- 2 – – Enable signal from external source connected to **EXTERNAL ENABLE** pin
- 2 – 1 – LDO is **DISABLED**
- 2 – 3 – LDO is **ENABLED**

Note: Do not connect external signal to **EXTERNAL ENABLE** pin if jumper is fitted