

## L0805CR27MSMST

Aliases (L0805CR27MSMST)

Obsolete

KEMET, L-SMS, Commercial Grade, 0.27 uH, 20%

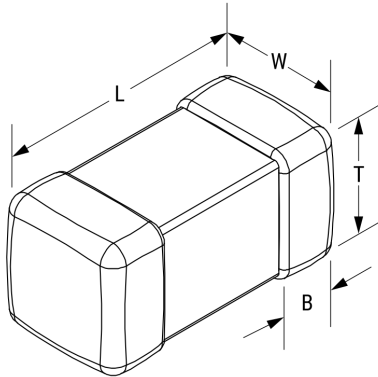

Click [here](#) for the 3D model.

### Dimensions

Chip Size	0805
L	2mm +0.3/-0.1mm
W	1.25mm +/-0.2mm
T	0.85mm +/-0.2mm
LL	0.5mm +/-0.2mm
B	0.5mm +/-0.2mm

### Packaging Specifications

Packaging	T&R
Packaging Quantity	4000

### General Information

Series	L-SMS
Style	SMD Chip
Description	Shielded, Surface Mount Inductor
Features	Standard Type
RoHS	Yes
Core	Ceramic
Winding Type	Multilayer
Notes	Suggested Replacement - <a href="https://www.chilisin.com/en-global/Inductor/Product/BSCL_201209/BSCL00201209R27M00">https://www.chilisin.com/en-global/Inductor/Product/BSCL_201209/BSCL00201209R27M00</a> .

### Specifications

Inductance	0.27 uH
Inductance Tolerance	20%
Temperature Range	-40/+85°C
Current	250 mAmps (MAX)
DC Resistance	0.5 Ohms
Quality Factor	20 at 25 MHz
Self-Resonant Frequency	150 MHz

Statements of suitability for certain applications are based on our knowledge of typical operating conditions for such applications, but are not intended to constitute - and we specifically disclaim - any warranty concerning suitability for a specific customer application or use. This information is intended for use only by customers who have the requisite experience and capability to determine the correct products for their application. Any technical advice inferred from this information or otherwise provided by us with reference to the use of our products is given gratis, and we assume no obligation or liability for the advice given or results obtained.