

Data sheet | Item number: 806-106

2-conductor female connector; 1.5 mm²; Pin spacing 5 mm; 6-pole; 1,50 mm²; gray

www.wago.com/806-106



Color: —

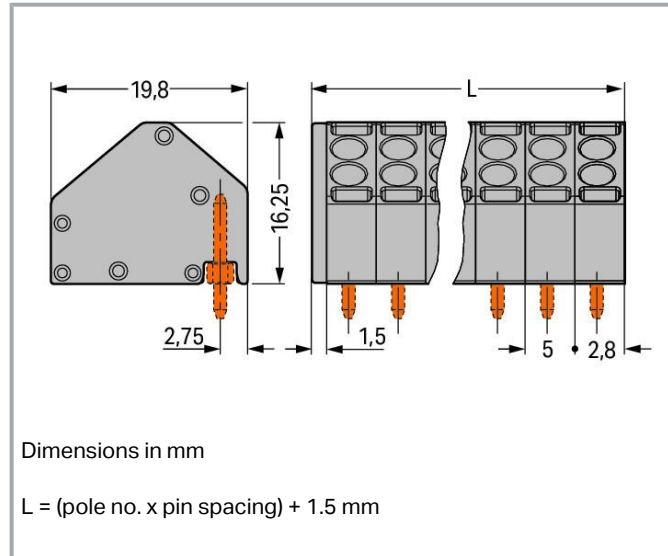

Item description

- 2-conductor female connector with Push-in CAGE CLAMP® and screwdriver actuation
- Push-in termination of solid and ferruled conductors
- Double entries for power supply and potential distribution
- Quick and easy PCB replacement, without disrupting looped-through potentials

Data

Notes

Variants:

Other pole numbers

Other colors

Mixed-color PCB connector strips

Direct marking

Other versions (or variants) can be requested from WAGO Sales or configured at <https://configurator.wago.com/>.

Electrical data

Subject to changes. Please also observe the further product documentation!

WAGO GmbH & Co. KG

Hansastr. 27

32423 Minden

Phone: +49571 887-0 | Fax: +49571 887-169

Email: info.de@wago.com | Web: www.wago.com

Do you have any questions about our products?

We are always happy to take your call at +49 (571) 887-44222.



Ratings per IEC/EN

Ratings per	IEC/EN 60664-1
Nominal voltage (III/3)	250 V
Rated impulse voltage (III/3)	4 kV
Rated voltage (III/2)	320 V
Rated impulse voltage (III/2)	4 kV
Nominal voltage (II/2)	630 V
Rated surge voltage (II/2)	4 kV
Rated current	10 A
Legend (ratings)	(III / 2) $\hat{=}$ Overvoltage category III / Pollution degree 2

Ratings per UL 1059

Approvals per	UL 1059
Rated voltage UL (Use Group B)	300 V
Rated current UL (Use Group B)	10 A
Rated voltage UL (Use Group D)	300 V
Rated current UL (Use Group D)	10 A

Ratings per CSA

Approvals per	CSA
Rated voltage CSA (Use Group B)	300 V
Rated current CSA (Use Group B)	10 A

Connection data

Connection points	12
Total number of potentials	6
Number of connection types	1
Number of levels	1

Connection 1

Connection technology	Push-in CAGE CLAMP®
Actuation type	Operating tool
Solid conductor	0.2 ... 1.5 mm ² / 24 ... 16 AWG
Fine-stranded conductor	0.2 ... 1.5 mm ² / 24 ... 16 AWG
Fine-stranded conductor; with insulated ferrule	0.25 ... 1 mm ²
Fine-stranded conductor; with uninsulated ferrule	0.25 ... 1 mm ²

Subject to changes. Please also observe the further product documentation!



Strip length	9 ... 10 mm / 0.35 ... 0.39 inches
Conductor connection direction to PCB	45 °
Pole number	6

Physical data

Pin spacing	5 mm / 0.197 inches
Width	31.5 mm / 1.24 inches
Height	16.25 mm / 0.64 inches
Depth	19.8 mm / 0.78 inches
Solder pin diameter	1 mm

Plug-in connection

Contact type (pluggable connector)	Female connector/socket
Connector (connection type)	for PCB
Mating direction to the PCB	90 °

Material Data

Note (material data)	Information on material specifications can be found here
Color	gray
Material group	I
Insulation material	Polyamide (PA66)
Flammability class per UL94	V0
Clamping spring material	Chrome-nickel spring steel (CrNi)
Contact material	Copper alloy
Contact plating	Tin
Fire load	0.152 MJ
Weight	7.7 g

Environmental requirements

Limit temperature range	-60 ... +105 °C
-------------------------	-----------------

Commercial data

Product Group	4 (Printed Circuit Connectors)
eCl@ss 10.0	27-44-04-01
eCl@ss 9.0	27-44-04-01

Subject to changes. Please also observe the further product documentation!





ETIM 8.0	EC002643
ETIM 7.0	EC002643
PU (SPU)	150 pcs
Packaging type	box
Country of origin	PL
GTIN	4045454076948
Customs tariff number	85366990990

Environmental Product Compliance

RoHS Compliance Status	Compliant, No Exemption
------------------------	-------------------------

Approvals / Certificates

General approvals

Logo	Approval	Additional Approval Text	Certificate name
	CCA DEKRA Certification B.V.	EN 60947-7-4	71- 112254
	CCA DEKRA Certification B.V.	EN 60947-7-4	NTR NL- 7808
	CSA DEKRA Certification B.V.	C22.2	1132097
	UR Underwriters Laboratories Inc.	UL 1059	E45172

















Required accessories

Male connector

Solder pin	
	<p>Item no.: 806-906</p> <p>THT male header; straight; Pin spacing 5 mm; 6-pole; black</p>
	www.wago.com/806-906

Subject to changes. Please also observe the further product documentation!

Optional accessories

Ferrule		
	Item no.: 216-101 Ferrule; Sleeve for 0.5 mm ² / AWG 22; uninsulated; electro-tin plated; silver-colored	www.wago.com/216-101
	Item no.: 216-102 Ferrule; Sleeve for 0.75 mm ² / AWG 20; uninsulated; electro-tin plated; silver-colored	www.wago.com/216-102
	Item no.: 216-103 Ferrule; Sleeve for 1 mm ² / AWG 18; uninsulated; electro-tin plated	www.wago.com/216-103
	Item no.: 216-123 Ferrule; Sleeve for 1 mm ² / AWG 18; uninsulated; electro-tin plated; silver-colored	www.wago.com/216-123
	Item no.: 216-122 Ferrule; Sleeve for 0.75 mm ² / AWG 20; uninsulated; electro-tin plated; silver-colored	www.wago.com/216-122
	Item no.: 216-142 Ferrule; Sleeve for 0.75 mm ² / 18 AWG; uninsulated; electro-tin plated; electrolytic copper; gastight crimped; acc. to DIN 46228, Part 1/08.92	www.wago.com/216-142
	Item no.: 216-132 Ferrule; Sleeve for 0.34 mm ² / AWG 24; uninsulated; electro-tin plated	www.wago.com/216-132
	Item no.: 216-121 Ferrule; Sleeve for 0.5 mm ² / AWG 22; uninsulated; electro-tin plated; silver-colored	www.wago.com/216-121
	Item no.: 216-143 Ferrule; Sleeve for 1 mm ² / AWG 18; uninsulated; electro-tin plated; electrolytic copper; gastight crimped; acc. to DIN 46228, Part 1/08.92	www.wago.com/216-143
	Item no.: 216-131 Ferrule; Sleeve for 0.25 mm ² / AWG 24; uninsulated; electro-tin plated; silver-colored	www.wago.com/216-131
	Item no.: 216-141 Ferrule; Sleeve for 0.5 mm ² / 20 AWG; uninsulated; electro-tin plated; electrolytic copper; gastight crimped; acc. to DIN 46228, Part 1/08.92	www.wago.com/216-141
	Item no.: 216-152 Ferrule; Sleeve for 0.34 mm ² / AWG 24; uninsulated; electro-tin plated	www.wago.com/216-152
	Item no.: 216-203 Ferrule; Sleeve for 1 mm ² / AWG 18; insulated; electro-tin plated; red	www.wago.com/216-203
	Item no.: 216-202 Ferrule; Sleeve for 0.75 mm ² / 18 AWG; insulated; electro-tin plated; gray	www.wago.com/216-202
	Item no.: 216-151 Ferrule; Sleeve for 0.25 mm ² / AWG 24; uninsulated; electro-tin plated	www.wago.com/216-151
	Item no.: 216-201 Ferrule; Sleeve for 0.5 mm ² / 20 AWG; insulated; electro-tin plated; white	www.wago.com/216-201
	Item no.: 216-223	

Subject to changes. Please also observe the further product documentation!

Ferrule; Sleeve for 1 mm² / AWG 18; insulated; electro-tin plated; redwww.wago.com/216-223**Item no.: 216-241**Ferrule; Sleeve for 0.5 mm² / 20 AWG; insulated; electro-tin plated; electrolytic copper; gastight crimped; acc. to DIN 46228, Part 4/09.90; whitewww.wago.com/216-241**Item no.: 216-242**Ferrule; Sleeve for 0.75 mm² / 18 AWG; insulated; electro-tin plated; electrolytic copper; gastight crimped; acc. to DIN 46228, Part 4/09.90; graywww.wago.com/216-242**Item no.: 216-222**Ferrule; Sleeve for 0.75 mm² / 18 AWG; insulated; electro-tin plated; graywww.wago.com/216-222**Item no.: 216-221**Ferrule; Sleeve for 0.5 mm² / 20 AWG; insulated; electro-tin plated; whitewww.wago.com/216-221**Item no.: 216-243**Ferrule; Sleeve for 1 mm² / AWG 18; insulated; electro-tin plated; electrolytic copper; gastight crimped; acc. to DIN 46228, Part 4/09.90; redwww.wago.com/216-243**Item no.: 216-263**Ferrule; Sleeve for 1 mm² / AWG 18; insulated; electro-tin plated; electrolytic copper; gastight crimped; acc. to DIN 46228, Part 4/09.90; redwww.wago.com/216-263**Item no.: 216-264**Ferrule; Sleeve for 1.5 mm² / AWG 16; insulated; electro-tin plated; electrolytic copper; gastight crimped; acc. to DIN 46228, Part 4/09.90; blackwww.wago.com/216-264**Item no.: 216-284**Ferrule; Sleeve for 1.5 mm² / AWG 16; insulated; electro-tin plated; electrolytic copper; gastight crimped; acc. to DIN 46228, Part 4/09.90; blackwww.wago.com/216-284**Item no.: 216-262**Ferrule; Sleeve for 0.75 mm² / 18 AWG; insulated; electro-tin plated; electrolytic copper; gastight crimped; acc. to DIN 46228, Part 4/09.90; graywww.wago.com/216-262**Item no.: 216-301**Ferrule; Sleeve for 0.25 mm² / AWG 24; insulated; electro-tin plated; yellowwww.wago.com/216-301**Item no.: 216-321**Ferrule; Sleeve for 0.25 mm² / AWG 24; insulated; electro-tin plated; yellowwww.wago.com/216-321**Item no.: 216-322**Ferrule; Sleeve for 0.34 mm² / 22 AWG; insulated; electro-tin plated; light turquoisewww.wago.com/216-322**Item no.: 216-302**Ferrule; Sleeve for 0.34 mm² / 22 AWG; insulated; electro-tin plated; light turquoisewww.wago.com/216-302**Tool**

Operating tool

Item no.: 210-657

Operating tool; Blade: 3.5 x 0.5 mm; with a partially insulated shaft; short; multicoloured

www.wago.com/210-657**Item no.: 210-720**

Operating tool; Blade: 3.5 x 0.5 mm; with a partially insulated shaft; multicoloured

www.wago.com/210-720

Subject to changes. Please also observe the further product documentation!

WAGO GmbH & Co. KG

Hansastr. 27

32423 Minden

Phone: +49571 887-0 | Fax: +49571 887-169

Email: info.de@wago.com | Web: www.wago.com

Do you have any questions about our products?

We are always happy to take your call at +49 (571) 887-44222.



Marking accessories

Marking strip

	Item no.: 210-332/500-202 Marking strips; as a DIN A4 sheet; MARKED; 1-16 (160x); Height of marker strip: 3 mm; Strip length 182 mm; Horizontal marking; Self-adhesive; white	www.wago.com/210-332/500-202
	Item no.: 210-332/500-206 Marking strips; as a DIN A4 sheet; MARKED; 33-48 (160x); Height of marker strip: 3 mm; Strip length 182 mm; Horizontal marking; Self-adhesive; white	www.wago.com/210-332/500-206
	Item no.: 210-332/500-205 Marking strips; as a DIN A4 sheet; MARKED; 1-32 (80x); Height of marker strip: 3 mm; Strip length 182 mm; Horizontal marking; Self-adhesive; white	www.wago.com/210-332/500-205
	Item no.: 210-332/500-204 Marking strips; as a DIN A4 sheet; MARKED; 17-32 (160x); Height of marker strip: 3 mm; Strip length 182 mm; Horizontal marking; Self-adhesive; white	www.wago.com/210-332/500-204

Downloads

Documentation

Additional Information

Technical Section	2019 Apr 3	pdf	Download
Technical explanations		2.0 MB	

CAD/CAE-Data

CAD data

2D/3D Models 806-106	URL	Download
----------------------	-----	----------

CAE data

EPLAN Data Portal 806-106	URL	Download
---------------------------	-----	----------

ZUKEN Portal 806-106	URL	Download
----------------------	-----	----------

PCB Design

Symbol and Footprint 806-106	URL	Download
------------------------------	-----	----------

CAX data for your PCB design, consisting of "schematic symbols and PCB footprints", allow easy integration of the WAGO component into your development environment.

Supported formats:

Subject to changes. Please also observe the further product documentation!



- Accel EDA 14 & 15
- Altium 6 to current version
- Cadence Allegro
- DesignSpark
- Eagle Libraries
- KiCad
- Mentor Graphics BoardStation
- Mentor Graphics Design Architect
- Mentor Graphics Design Expedition 99 and 2000
- OrCAD 9.X PCB and Capture
- PADS PowerPCB 3, 3.5, 4.X, and 5.X
- PADS PowerPCB and PowerLogic 3.0
- PCAD 2000, 2001, 2002, 2004, and 2006
- Pulsonix 8.5 or newer
- STL
- 3D STEP
- TARGET 3001!
- View Logic ViewDraw
- Quadcept
- Zuken CadStar 3 and 4
- Zuken CR-5000 and CR-8000

PCB Component Libraries (EDA), PCB CAD Library Ultra Librarian

Environmental Product Compliance

Compliance Search

Environmental Product Compliance 806-106	URL	Download
2-conductor female connector; 1.5 mm ² ; Pin spacing 5 mm; 6-pole; 1,50 mm ² ; gray		

Installation Notes

Conductor termination

Subject to changes. Please also observe the further product documentation!

WAGO GmbH & Co. KG
Hansastr. 27
32423 Minden
Phone: +49571 887-0 | Fax: +49571 887-169
Email: info.de@wago.com | Web: www.wago.com

Do you have any questions about our products?
We are always happy to take your call at +49 (571) 887-44222.

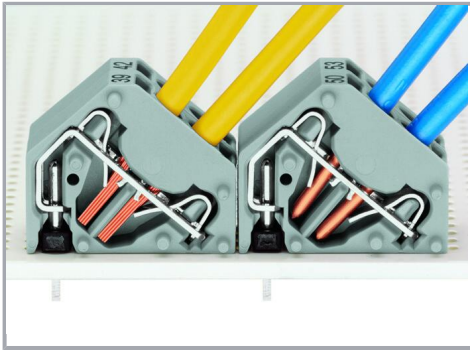

Inserting solid conductors via push-in termination.

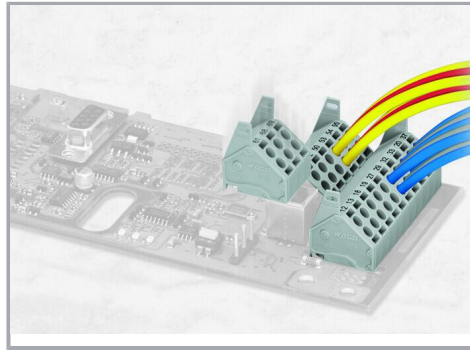

Conductor termination directly on the PCB or wiring prior to mounting on PCB

Inserting/removing fine-stranded conductors:
Open the clamping unit using a screwdriver
and insert a stripped conductor until it hits the
backstop.

Subject to changes. Please also observe the further product documentation!