

| | | | | | |
|------|-------------|--------------------|----------------|-----------------|-------------------------|
| REV. | ECR/ECN No. | DESCRIPTION | DRAWN/DATE | CHECKED/DATE | APPROVED/DATE |
| B | / | Update the drawing | May 2020-08-11 | Rain 2020-08-11 | Xiaohong.zhu 2020-08-11 |

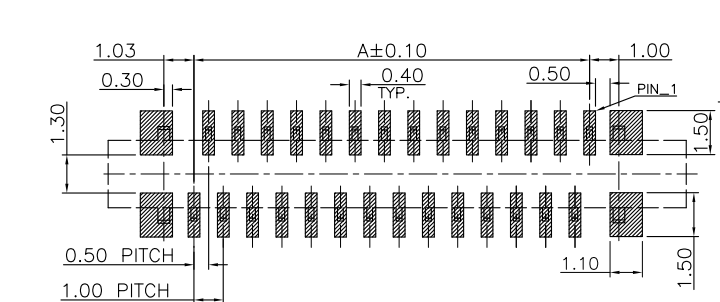

P.C.B LAYOUT A TYPE (REFERENCE) TOL:±0.05

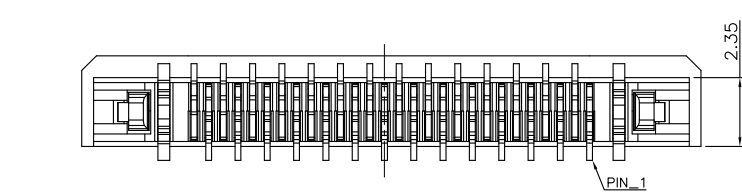
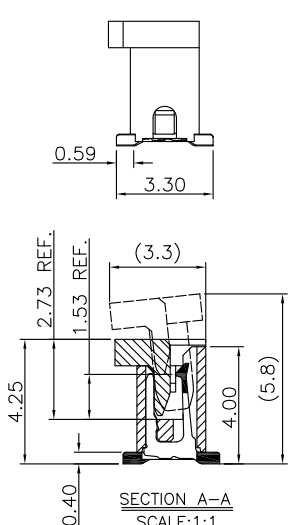
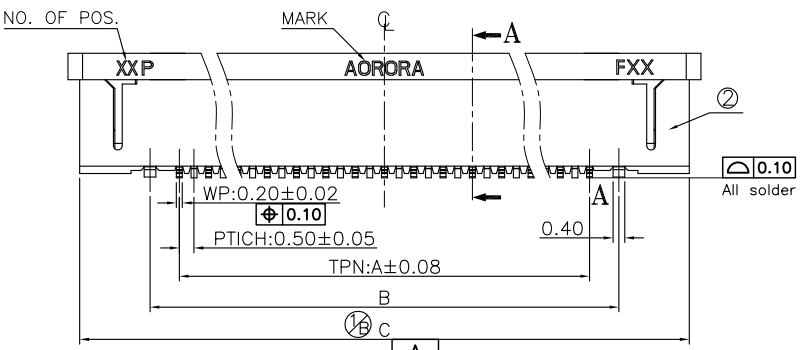
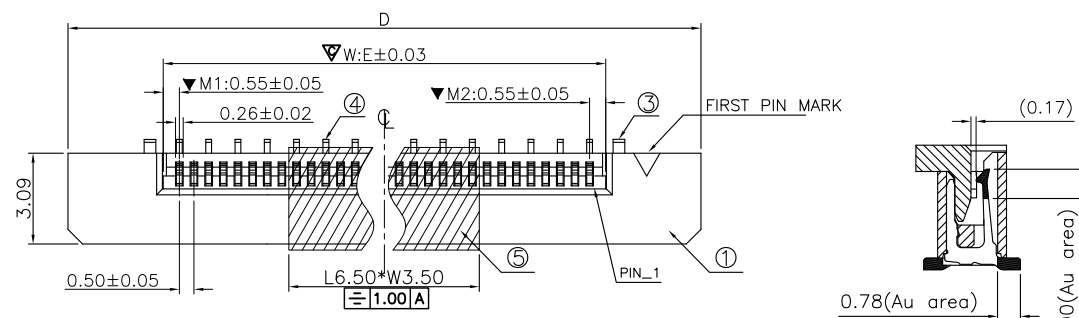
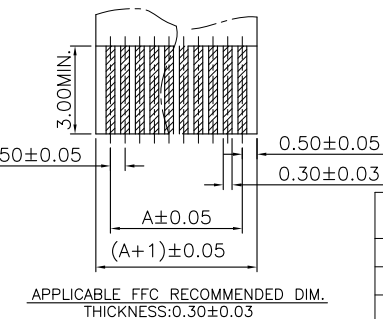

| NO. | COMPONENTS | MATERIALS | SPECIFICATION:FINISH/COLOR | QTY. |
|-----|--------------|----------------------------|---|------|
| 1 | SLIDER | GLASS FILLED PA9T, UL94V-0 | BLACK | 1 |
| 2 | HOUSING | GLASS FILLED LCP, UL94V-0 | NATURAL | 1 |
| 3 | ANCHOR-PLATE | BRASS, T=0.40mm | SURFACE PLATING:2~5 um Sn UNDER PLATING:1~3 um Ni | 1 |
| 4 | CONTACT | PHOSPHOR BRONZE, T=0.20mm | SURFACE PLATING:SEE "NOTE" UNDER PLATING:1~3 um Ni | N |
| 5 | MYLAR | T=0.10mm 耐高溫 | YELLOW | 1 |

NOTE:
 1.ALL MATERIAL MUST BE COMPLY WITH SS-00259/RoHS.
 2."▽" MARK IS IMPORTANT DIMENSIONS
 3."▽▽" MARK IS CPK AND X-R DIMENSION
 4.PART NO. LEGEND:
 F3**-1A7*1-110**

14:WITH MYLAR(A TYPE) NO. OF POSITIONS
 36:WITHOUT MYLAR(A TYPE) 7H:PHOSPHOR BRONZE 0.05um MIN Au(Au Area)
 1A:LCP NATURAL 7A:PHOSPHOR BRONZE MATTER TIN

DIMENSION LIST: (A)

| NO. OF POS. | A | B | C | D | E | NO. OF POS. | A | B | C | D | E |
|-------------|-------|-------|-------|-------|-------|-------------|-------|-------|-------|-------|-------|
| 30 | 14.50 | 16.50 | 21.30 | 22.10 | 15.60 | 45 | 22.00 | 24.00 | 28.80 | 29.60 | 23.10 |
| 31 | 15.00 | 17.00 | 21.80 | 22.60 | 16.10 | 46 | 22.50 | 24.50 | 29.30 | 30.10 | 23.60 |
| 32 | 15.50 | 17.50 | 22.30 | 23.10 | 16.60 | 47 | 23.00 | 25.00 | 29.80 | 30.60 | 24.10 |
| 33 | 16.00 | 18.00 | 22.80 | 23.60 | 17.10 | 48 | 23.50 | 25.50 | 30.30 | 31.10 | 24.60 |
| 34 | 16.50 | 18.50 | 23.30 | 24.10 | 17.60 | 49 | 24.00 | 26.00 | 30.80 | 31.60 | 25.10 |
| 35 | 17.00 | 19.00 | 23.80 | 24.60 | 18.10 | 50 | 24.50 | 26.50 | 31.30 | 32.10 | 25.60 |
| 36 | 17.50 | 19.50 | 24.30 | 25.10 | 18.60 | 51 | 25.00 | 27.00 | 31.80 | 32.60 | 26.10 |
| 37 | 18.00 | 20.00 | 24.80 | 25.60 | 19.10 | 52 | 25.50 | 27.50 | 32.30 | 33.10 | 26.60 |
| 38 | 18.50 | 20.50 | 25.30 | 26.10 | 19.60 | 53 | 26.00 | 28.00 | 32.80 | 33.60 | 27.10 |
| 39 | 19.00 | 21.00 | 25.80 | 26.60 | 20.10 | 54 | 26.50 | 28.50 | 33.30 | 34.10 | 27.60 |
| 40 | 19.50 | 21.50 | 26.30 | 27.10 | 20.60 | 55 | 27.00 | 29.00 | 33.80 | 34.60 | 28.10 |
| 41 | 20.00 | 22.00 | 26.80 | 27.60 | 21.10 | 56 | 27.50 | 29.50 | 34.30 | 35.10 | 28.60 |
| 42 | 20.50 | 22.50 | 27.30 | 28.10 | 21.60 | 57 | 28.00 | 30.00 | 34.80 | 35.60 | 29.10 |
| 43 | 21.00 | 23.00 | 27.80 | 28.60 | 22.10 | 58 | 28.50 | 30.50 | 35.30 | 36.10 | 29.60 |
| 44 | 21.50 | 23.50 | 28.30 | 29.10 | 22.60 | 59 | 29.00 | 31.00 | 35.80 | 36.60 | 30.10 |
| 45 | 22.00 | 24.00 | 28.80 | 29.60 | 23.10 | 60 | 29.50 | 31.50 | 36.30 | 37.10 | 30.60 |

| | | | | | | | | |
|---------------------------------------|-------|---------------------|------|--|-------------------------|---|------------------|-----------|
| UNLESS OTHERWISE SPECIFIED TOLERANCES | | ANGLE OF PROJECTION | | Amphenol Aorora Technology (Huizhou) Co.,Ltd | | | | |
| X. | ±0.30 | X. ' | ± 5' | | | | | |
| X.X | ±0.25 | X.X ' | ± 4' | DOC TYP | Customer Drw | | TITLE: | |
| X.XX | ±0.20 | X.XX ' | ± 3' | DRAWN | May 2014-12-25 | Assembly Drawing For 0.50mm pitch 30-60PIN VERTICAL SMT A TYPE,SLIDER SERIES | | |
| X.XXX | ±0.15 | X.XXX ' | ± 2' | DESIGN | May 2014-12-25 | | | |
| LINEAR DIMS | | ANGLES DIMS | | DATE | May 2014-12-25 | SIZE | PART NUMBER: | REV. |
| DWG NO.: A-S0107 | | | | CHECKED | Rain 2014-12-25 | A4 | F3**-1A7*1-110** | B |
| MATERIAL | | SEE NOTES | | APPROVED | Xiaohong.zhu 2014-12-25 | SCALE | 4:1 | UNIT : mm |
| FINISHED | | SEE NOTES | | DATE | | SHEET | 1 OF 2 | |

1. PACKING INTO REEL:

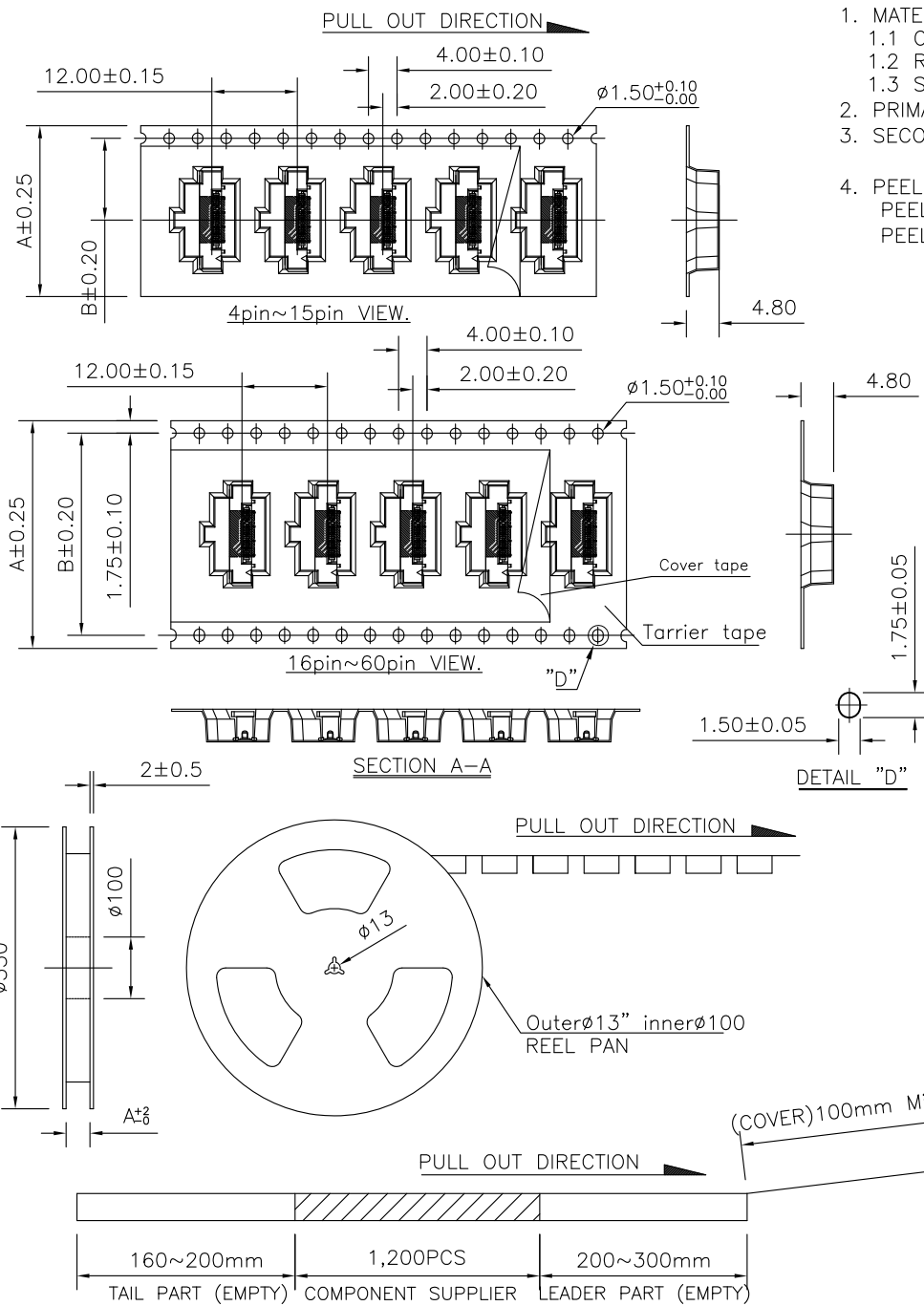

NOTES:

- MATERIAL:
 - CARRY TAPE:HIPS,T=0.35mm,CLEAR
 - REEL:HIPS,BLUE.
 - SHIM:PE,CLEAR.
- PRIMARY PACKING:1,200PCS/REEL.
- SECONDARY PACKING:"N"REELS/CARTON ("TOTAL"=N*1200/CARTON).
- PEELING RESISTANCE: 0.1N~0.7N(10~70gf);
PEELING ANGLE: 165°~180°;
PEELING SPEED: 300mm/minutes.

5. LIST

| DIM | NO. | 4~15 | 16~25 | 26~50 | 51~60 |
|------------|-----|-------|-------|-------|-------|
| A | | 24.00 | 32.00 | 44.00 | 56.00 |
| B | | 16.40 | 28.40 | 40.40 | 52.40 |
| N | | 10 | 8 | 6 | 5 |
| TOTAL(PCS) | | 12000 | 9600 | 7200 | 6000 |

2:PACKING INTO OUTER BOX

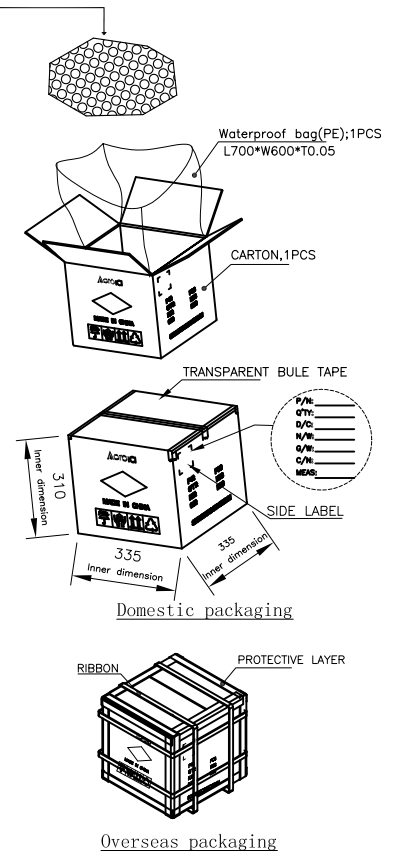
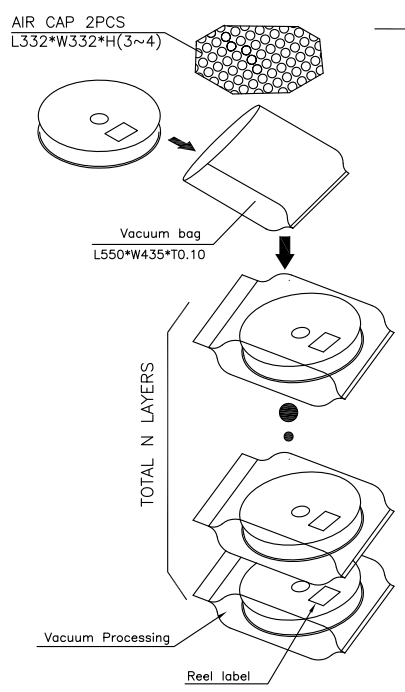

| UNLESS OTHERWISE SPECIFIED TOLERANCES | | | | ANGLE OF PROJECTION | | Amphenol AORORA | |
|---------------------------------------|-------------|---------|----------|---------------------|----------------|--|------------------|
| X. | ±0.30 | X. ' | ± 5' | | | Amphenol Aorora Technology (Huizhou) Co.,Ltd | |
| X.X | ±0.25 | X.X ' | ± 4' | | | TITLE: | |
| X.XX | ±0.20 | X.XX ' | ± 3' | DOC TYP | Customer Drw | Assembly Drawing For 0.50mm pitch 30-60PIN VERTICAL SMT A TYPE,SLIDER SERIES | |
| X.XXX | ±0.15 | X.XXX ' | ± 2' | DRAWN | May 2014-12-25 | SIZE | PART NUMBER: |
| LINEAR DIMS | ANGLES DIMS | | DESIGN | DATE | May 2014-12-25 | A4 | F3**-1A7*1-110** |
| DWG NO.: | A-S0107 | | CHECKED | DATE | 2014-12-25 | REV. | B |
| MATERIAL | SEE NOTES | | APPROVED | DATE | 2014-12-25 | SCALE | 1:1 |
| FINISHED | SEE NOTES | | | | | UNIT : mm | SHEET 2 OF 2 |