

# ESD1LIN24-Q1, ESD751-Q1, and ESD761-Q1 Automotive 24-V, 1-Channel ESD Protection Diodes for In-Vehicle Networks

## 1 Features

- IEC 61000-4-2 level 4 ESD protection:
  - ±30-kV, ±22-kV or ±15-kV contact discharge
  - ±30-kV, ±22-kV or ±15-kV air-gap discharge
- ISO 10605 (330 pF, 330 Ω) ESD protection:
  - ±30-kV, ±22-kV or ±15-kV contact discharge
  - ±30-kV, ±22-kV or ±15-kV air-gap discharge
- 24-V working voltage
- Bidirectional ESD protection
- Low clamping voltage protects downstream components
- AEC-Q101 qualified
- Temperature range: -55°C to +150°C
- I/O capacitance = 2.3 pF, 1.6 pF, or 1.1 pF (typical)
- Offered in industry standard packages: SOD-323 (DYF), SOD-523 (DYA), and 0402 size leadless package (DPY)
- Leaded packages used for automatic optical inspection (AOI)

## 2 Applications

- Automotive in-vehicle networks:**
  - Local interconnect network (LIN)
  - Single line CAN ESD protection
- Industrial control networks:**
  - DeviceNet
  - Smart distribution systems

## 3 Description

The ESD1LIN24-Q1, ESD751-Q1, and ESD761-Q1 are single-channel low capacitance bidirectional ESD protection devices for local interconnect network (LIN). These devices are rated to dissipate contact ESD strikes beyond the maximum level specified in the IEC 61000-4-2 international standard (±30-kV Contact, ±30-kV Airgap), (±22-kV Contact, ±22-kV Airgap), and (±15-kV Contact, ±15-kV Airgap), respectively. The low dynamic resistance and low clamping voltage help protect systems against transient events. This protection is key as automotive systems require a high level of robustness and reliability when they control safety devices.

The ESD1LIN24-Q1 and ESD751-Q1 are both offered in leaded packages for easy flow through routing.

### Package Information<sup>(1)</sup>

PART NUMBER	PACKAGE	BODY SIZE (NOM)
ESD1LIN24-Q1	DYF (SOD-323, 2)	2.50 mm × 1.20 mm
ESD751-Q1	DYA (SOD-523, 2)	1.60 mm × 0.80 mm
ESD761-Q1	DPY (X1SON, 2)	1.00 mm × 0.60 mm

(1) For all available packages, see the orderable addendum at the end of the data sheet.

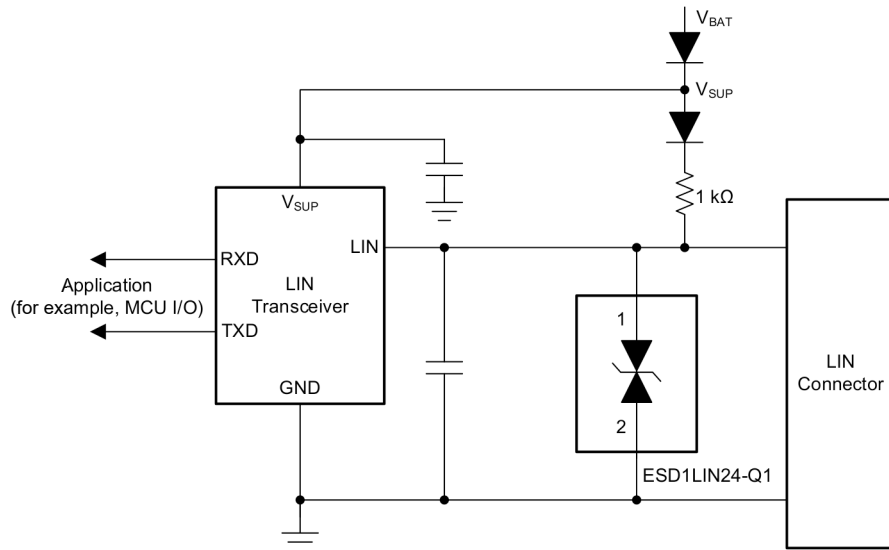

Typical Application



## Table of Contents

<b>1 Features</b> .....	1	7.3 Feature Description.....	10
<b>2 Applications</b> .....	1	7.4 Device Functional Modes.....	11
<b>3 Description</b> .....	1	<b>8 Application and Implementation</b> .....	12
<b>4 Revision History</b> .....	2	8.1 Application Information.....	12
<b>5 Pin Configuration and Functions</b> .....	3	8.2 Typical Application.....	12
<b>6 Specifications</b> .....	4	<b>9 Power Supply Recommendations</b> .....	13
6.1 Absolute Maximum Ratings.....	4	<b>10 Layout</b> .....	13
6.2 ESD Ratings—AEC Specification.....	4	10.1 Layout Guidelines.....	13
6.3 ESD Ratings—IEC Specification.....	4	10.2 Layout Example.....	14
6.4 ESD Ratings - ISO Specification.....	5	<b>11 Device and Documentation Support</b> .....	15
6.5 Recommended Operating Conditions.....	5	11.1 Documentation Support.....	15
6.6 Thermal Information.....	5	11.2 Receiving Notification of Documentation Updates..	15
6.7 Electrical Characteristics.....	5	11.3 Support Resources.....	15
6.8 Typical Characteristics – ESD751.....	7	11.4 Trademarks.....	15
6.9 Typical Characteristics – ESD1LIN24.....	8	11.5 Electrostatic Discharge Caution.....	15
6.10 Typical Characteristics - ESD761.....	9	11.6 Glossary.....	15
<b>7 Detailed Description</b> .....	10	<b>12 Mechanical, Packaging, and Orderable Information</b> .....	15
7.1 Overview.....	10		
7.2 Functional Block Diagram.....	10		

## 4 Revision History

NOTE: Page numbers for previous revisions may differ from page numbers in the current version.

<b>Changes from Revision B (November 2022) to Revision C (December 2022)</b>	<b>Page</b>
• Changed the status of the ESD1LIN24-Q1 and ESD761-Q1 device from: <i>Advanced Information</i> to: <i>Production Data</i> .....	1
• Updated the Thermal Specifications and Clamping Voltages in the <i>Thermal Information</i> and <i>Electrical Characteristics</i> table.....	4

<b>Changes from Revision A (September 2022) to Revision B (November 2022)</b>	<b>Page</b>
• Changed the status of the ESD751-Q1 device from: <i>Advanced Information</i> to: <i>Production Data</i> .....	1

## 5 Pin Configuration and Functions

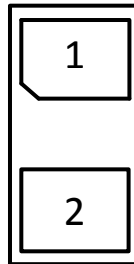

**Figure 5-1. DPY Package, 2-Pin X1SON (Top View)**

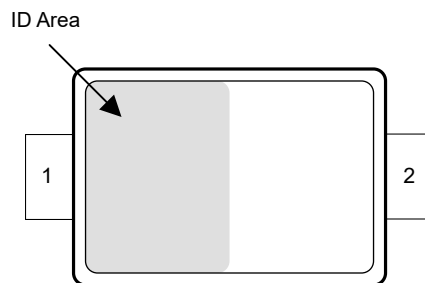

**Figure 5-2. DYF Package, 2-Pin SOD-323 (Top View)**

**Table 5-1. Pin Functions**

PIN		TYPE <sup>(1)</sup>	DESCRIPTION
NAME	NO.		
IO	1	I/O	ESD protected IO
GND	2	G	Connect to ground.

(1) I = Input, O = Output, I/O = Input or Output, G = Ground, P = Power.

## 6 Specifications

### 6.1 Absolute Maximum Ratings

over operating free-air temperature range (unless otherwise noted)<sup>(1)</sup>

		DEVICE	MIN	MAX	UNIT
P <sub>PP</sub>	IEC 61000-4-5 Power (t <sub>p</sub> - 8/20 μs) at 25°C	ESD1LIN24-Q1		159	W
		ESD751-Q1		102	
		ESD761-Q1		65	
I <sub>PP</sub>	IEC 61000-4-5 current (t <sub>p</sub> - 8/20 μs) at 25°C	ESD1LIN24-Q1		4.3	A
		ESD751-Q1		2.8	
		ESD761-Q1		1.8	
T <sub>A</sub>	Operating free-air temperature		-55	150	°C
T <sub>J</sub>	Junction temperature		-55	150	
T <sub>stg</sub>	Storage temperature		-65	155	

- (1) Operation outside the Absolute Maximum Ratings may cause permanent device damage. Absolute Maximum Ratings do not imply functional operation of the device at these or any other conditions beyond those listed under Recommended Operating Conditions. If used outside the Recommended Operating Conditions but within the Absolute Maximum Ratings, the device may not be fully functional, and this may affect device reliability, functionality, performance, and shorten the device lifetime.

### 6.2 ESD Ratings—AEC Specification

			VALUE	UNIT
V <sub>(ESD)</sub>	Electrostatic discharge	Human body model (HBM), per AEC Q101-001 <sup>(1)</sup>	± 2500	V
		Charged device model (CDM), per AEC Q101-005	± 1000	

- (1) AEC Q100-002 indicates that HBM stressing must be in accordance with the ANSI/ESDA/JEDEC JS-001 specification.

### 6.3 ESD Ratings—IEC Specification

			DEVICE	VALUE	UNIT
V <sub>(ESD)</sub>	Electrostatic discharge	IEC 61000-4-2 Contact Discharge, all pins	ESD1LIN24-Q1	±30000	V
			ESD751-Q1	±22000	
			ESD761-Q1	±15000	
		IEC 61000-4-2 Air-gap Discharge, all pins	ESD1LIN24-Q1	±30000	
			ESD751-Q1	±22000	
			ESD761-Q1	±15000	

## 6.4 ESD Ratings - ISO Specification

				DEVICE	VALUE	UNIT
V <sub>(ESD)</sub>	Electrostatic discharge	Contact discharge	ISO 10605, 150-pF, 330-Ω, IO	ESD1LIN24-Q1	± 30000	V
				ESD751-Q1	± 22000	
				ESD761-Q1	± 15000	
		ISO 10605, 330-pF, 330-Ω, IO	ESD1LIN24-Q1	± 30000		
			ESD751-Q1	± 22000		
			ESD761-Q1	± 15000		
	Air-gap discharge	ISO 10605, 150-pF, 330-Ω, IO	ESD1LIN24-Q1	± 30000		
			ESD751-Q1	± 22000		
			ESD761-Q1	± 15000		
		ISO 10605, 330-pF, 330-Ω, IO	ESD1LIN24-Q1	± 30000		
			ESD751-Q1	± 22000		
			ESD761-Q1	± 15000		

## 6.5 Recommended Operating Conditions

over operating free-air temperature range (unless otherwise noted)

		MIN	NOM	MAX	UNIT
V <sub>IN</sub>	Input voltage	-24		24	V
T <sub>A</sub>	Operating free-air temperature	-55		150	°C

## 6.6 Thermal Information

THERMAL METRIC <sup>(1)</sup>		ESD1LIN24-Q1	ESD751-Q1	ESD761-Q1	UNIT
		DYF (SOD-323)	DYA (SOD-523)	DPY (X1SON)	
		2 PINS	2 PINS	2 PINS	
R <sub>θJA</sub>	Junction-to-ambient thermal resistance	705.4	746.3	282.3	°C/W
R <sub>θJC(top)</sub>	Junction-to-case (top) thermal resistance	315	301.2	150.6	°C/W
R <sub>θJB</sub>	Junction-to-board thermal resistance	561.5	509.6	98.3	°C/W
Ψ <sub>JT</sub>	Junction-to-top characterization parameter	145	81.8	9.6	°C/W
Ψ <sub>JB</sub>	Junction-to-board characterization parameter	550.2	503.0	97.7	°C/W
R <sub>θJC(bot)</sub>	Junction-to-case (bottom) thermal resistance	N/A	N/A	N/A	°C/W

(1) For more information about traditional and new thermal metrics, see the [Semiconductor and IC Package Thermal Metrics](#) application report.

## 6.7 Electrical Characteristics

over T<sub>A</sub> = 25°C (unless otherwise noted)

PARAMETER		TEST CONDITIONS	DEVICE	MIN	TYP	MAX	UNIT
V <sub>RWM</sub>	Reverse stand-off voltage			-24		24	V
V <sub>BRF</sub>	Breakdown voltage <sup>(1)</sup>	I <sub>IO</sub> = 10 mA, IO to GND		25.5		35.5	V
V <sub>BRR</sub>	Breakdown voltage <sup>(1)</sup>	I <sub>IO</sub> = -10 mA, IO to GND		-35.5		-25.5	V
V <sub>CLAMP</sub>	Clamping voltage <sup>(2)</sup>	I <sub>PP</sub> = 4.3 A, t <sub>p</sub> = 8/20 μs, IO to GND and GND to IO	ESD1LIN24-Q1		37		V
		I <sub>PP</sub> = 2.8 A, t <sub>p</sub> = 8/20 μs, IO to GND and GND to IO	ESD751-Q1		36.5		
		I <sub>PP</sub> = 1.8 A, t <sub>p</sub> = 8/20 μs, IO to GND and GND to IO	ESD761-Q1		36.3		

## 6.7 Electrical Characteristics (continued)

over  $T_A = 25^\circ\text{C}$  (unless otherwise noted)

PARAMETER		TEST CONDITIONS	DEVICE	MIN	TYP	MAX	UNIT
$V_{\text{CLAMP}}$	Clamping voltage <sup>(3)</sup>	$I_{\text{PP}} = 16 \text{ A}$ , TLP, IO to GND and GND to IO	ESD1LIN24-Q1		40		V
			ESD751-Q1		41.5		
			ESD761-Q1		42.5		V
$I_{\text{LEAK}}$	Leakage current	$V_{\text{IO}} = \pm 24 \text{ V}$ , IO to GND		-50	1	50	nA
$R_{\text{DYN}}$	Dynamic resistance <sup>(3)</sup>		ESD1LIN24-Q1		0.5		$\Omega$
			ESD751-Q1		0.6		
			ESD761-Q1		0.53		
$C_L$	Line capacitance	$V_{\text{IO}} = 0 \text{ V}$ , $f = 1 \text{ MHz}$ , $V_{\text{pp}} = 30 \text{ mV}$ , IO to GND	ESD1LIN24-Q1		2.3	3.8	pF
			ESD751-Q1		1.6	2.7	
			ESD761-Q1		1.1	1.8	

- (1)  $V_{\text{BRF}}$  and  $V_{\text{BRR}}$  are defined as the voltage when  $\pm 10 \text{ mA}$  is applied in the positive-going direction, before the device latches into the snapback state.
- (2) Device stressed with  $8/20 \mu\text{s}$  exponential decay waveform according to IEC 61000-4-5.
- (3) Non-repetitive current pulse, Transmission Line Pulse (TLP); square pulse; ANSI / ESD STM5.5.1-2008

### 6.8 Typical Characteristics – ESD751

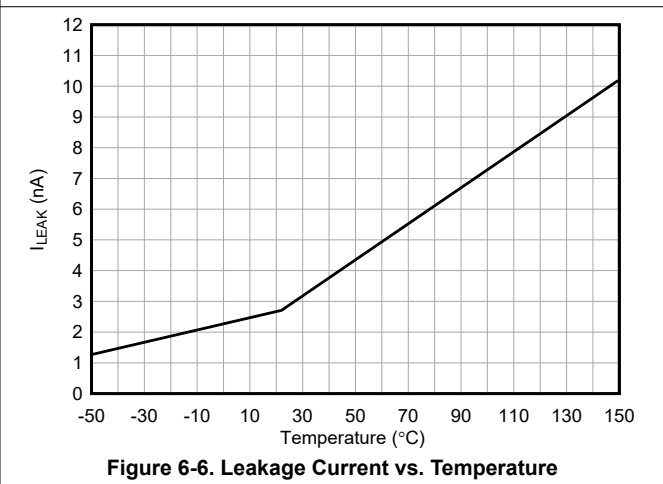
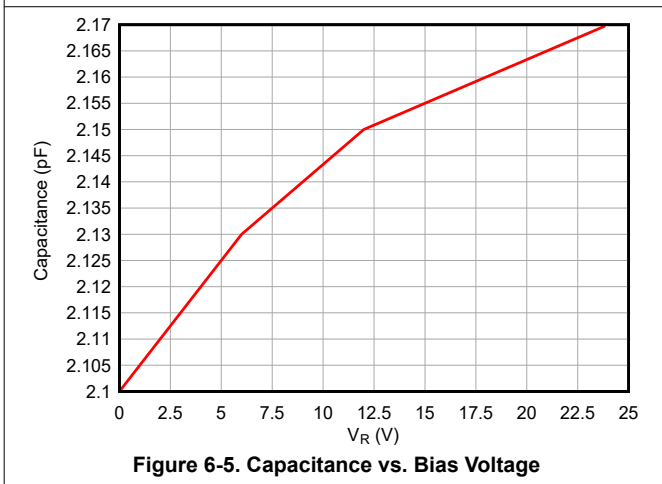
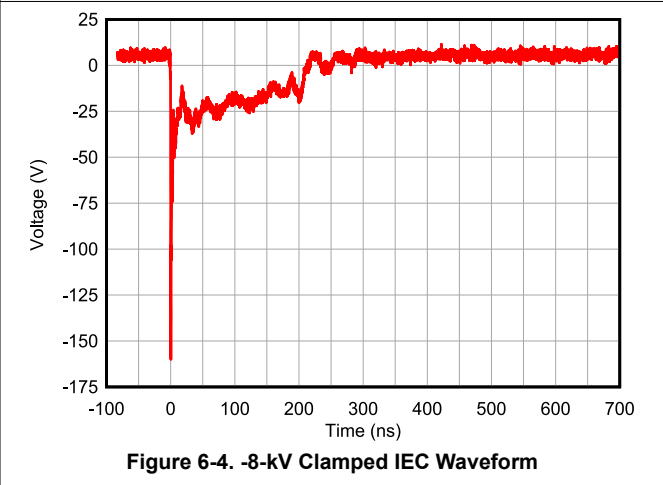
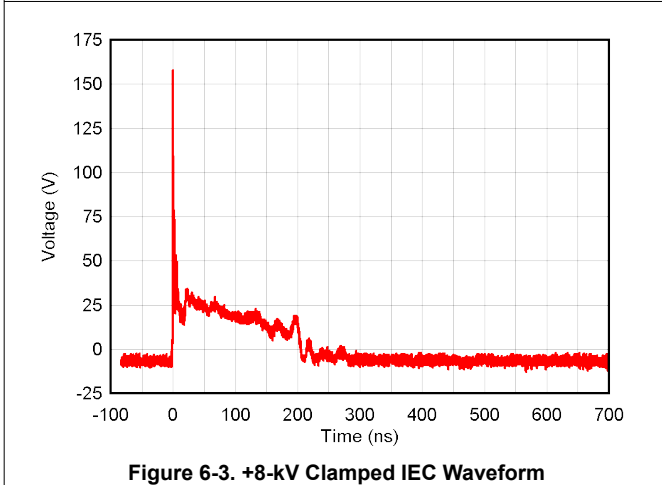
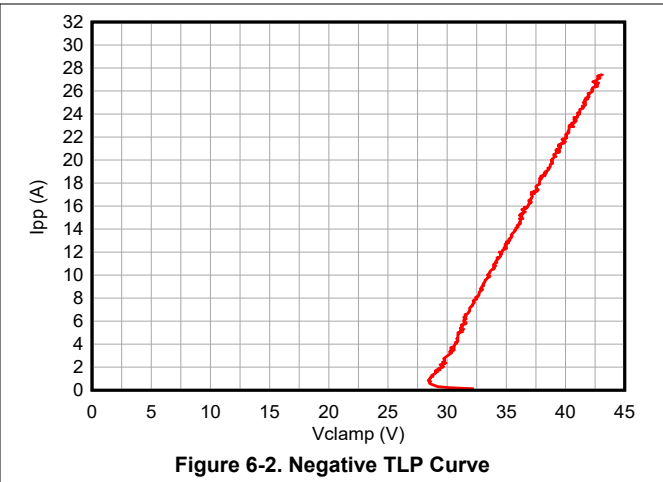
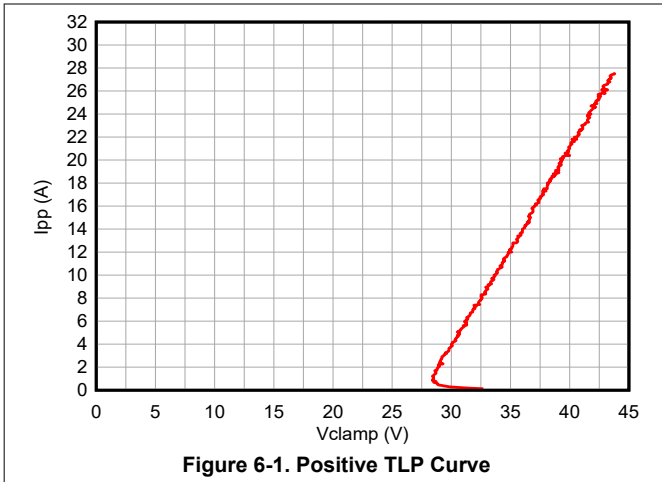

## 6.9 Typical Characteristics – ESD1LIN24

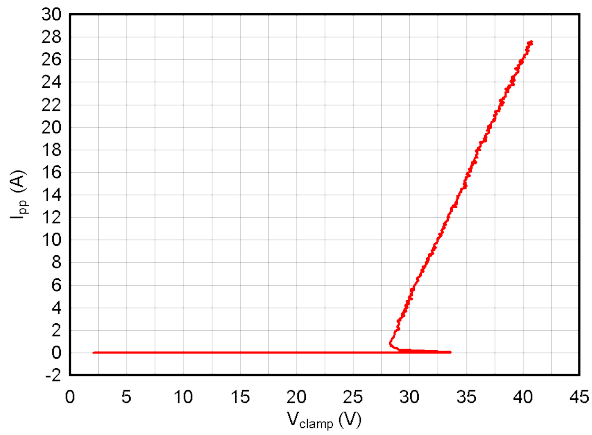

Figure 6-7. Positive TLP Curve

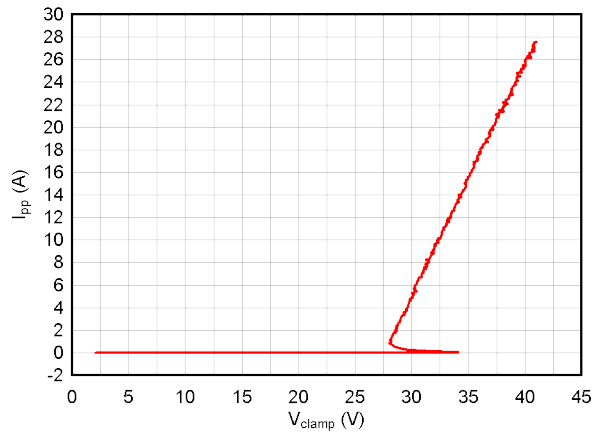

Figure 6-8. Negative TLP Curve

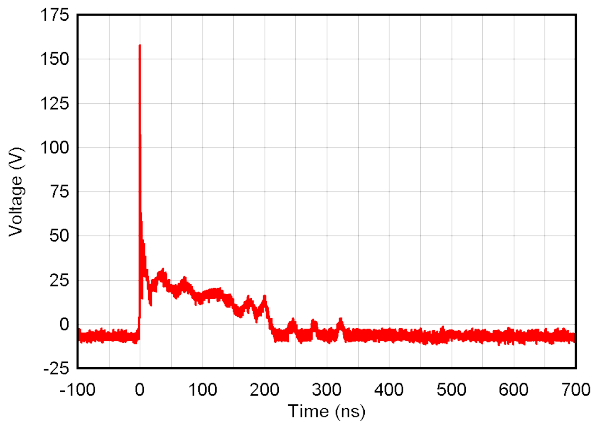

Figure 6-9. +8-kV Clamped IEC Waveform

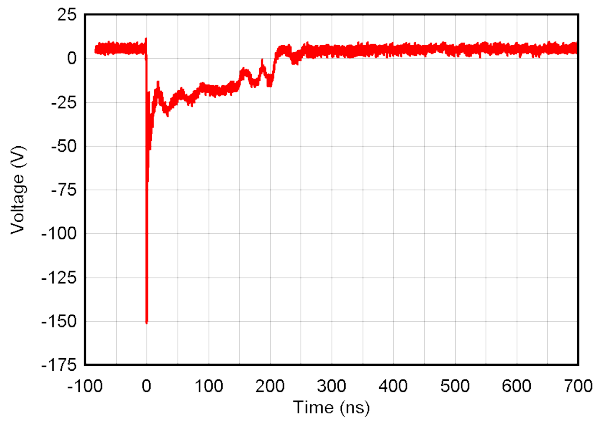

Figure 6-10. -8-kV Clamped IEC Waveform

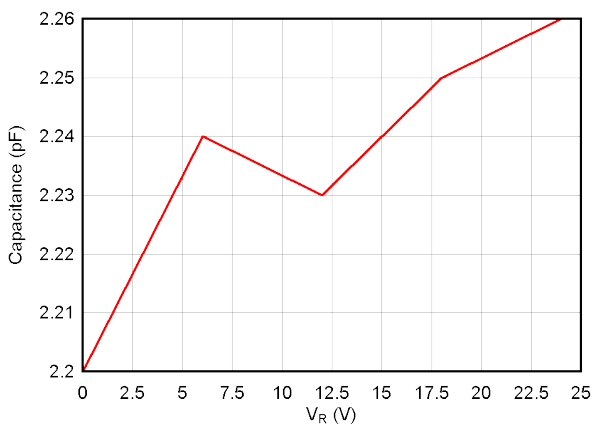

Figure 6-11. Capacitance vs. Bias Voltage

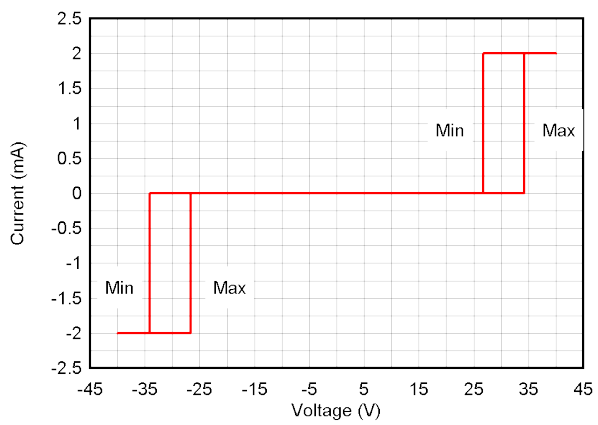

Figure 6-12. DC Voltage Sweep I-V Curve



## 6.10 Typical Characteristics - ESD761

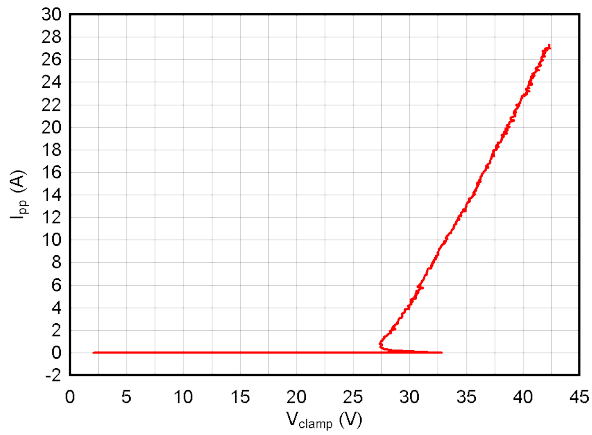

Figure 6-13. Positive TLP Curve

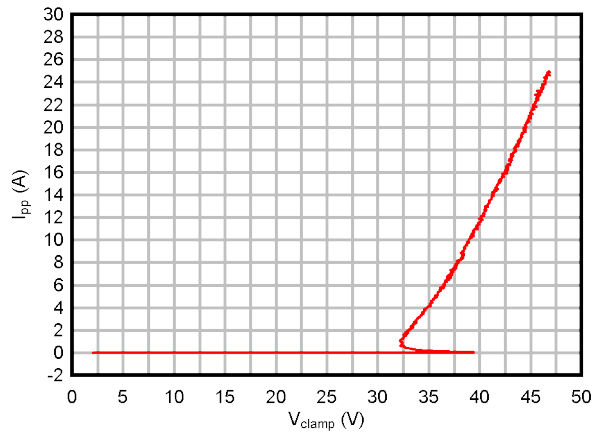

Figure 6-14. Negative TLP Curve

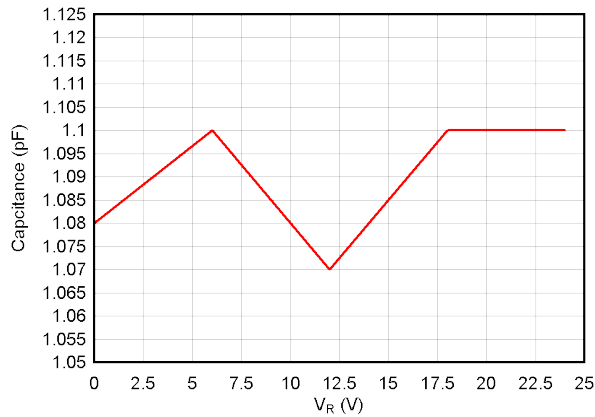

Figure 6-15. Capacitance vs. Bias Voltage

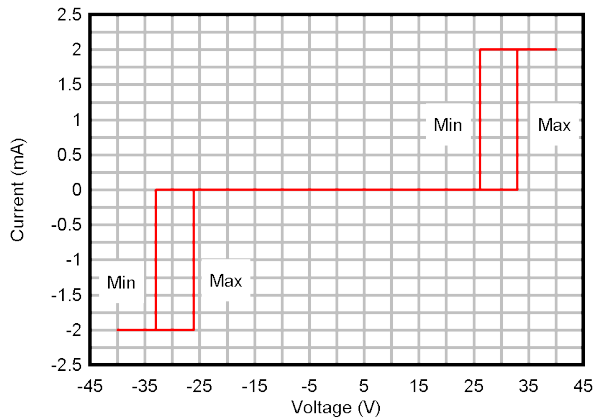

Figure 6-16. DC Voltage Sweep I-V Curve

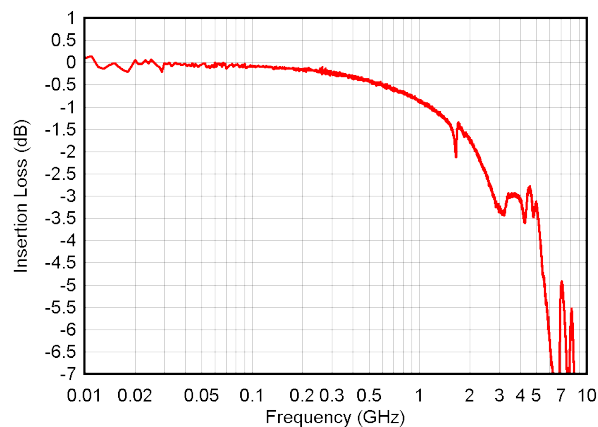

Figure 6-17. Insertion Loss

## 7 Detailed Description

### 7.1 Overview

The ESD1LIN24-Q1, ESD751-Q1, and ESD761-Q1 are single-channel ESD diodes available in industry standard packages (SOD-323 and SOD-523) which are convenient for automatic optical inspection as well as a smaller leadless package X1SON (DPY). These products offer ISO 10605 ESD ratings of ( $\pm 30$ -kV Contact,  $\pm 30$ -kV Airgap), ( $\pm 22$ -kV Contact,  $\pm 22$ -kV Airgap), and ( $\pm 15$ -kV Contact,  $\pm 15$ -kV Airgap), respectively. The 2.3 pF, 1.6 pF, and 1.1 pF line capacitance of these ESD protection diodes are suitable for LIN applications that support data rates from 20 Kbps to 10 Mbps.

Typical application of these products is the ESD circuit protection for LIN transceivers used in automotive applications. These devices are commonly used for ESD protection inside automotive electronic control units (ECUs) for head lights, door modules, climate control, roof control, wipers, cluster, audio, and many other automotive applications.

### 7.2 Functional Block Diagram

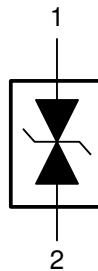

### 7.3 Feature Description

The ESD1LIN24-Q1, ESD751-Q1, and ESD761-Q1 are single-channel bidirectional ESD diodes with a high ESD protection level. These devices have a small dynamic resistance, which makes the clamping voltage low when the device is actively protecting other circuits. The breakdown is bidirectional so these protection devices can prevent system damage if battery leads are swapped. Low leakage allows the diodes to conserve power when working below the  $V_{RWM}$ . The temperature range of  $-55^{\circ}\text{C}$  to  $+150^{\circ}\text{C}$  makes these ESD devices work at extensive temperatures in most environments.

#### 7.3.1 IEC 61000-4-5 Surge Protection

The I/O pins of the ESD1LIN24-Q1, ESD751-Q1, ESD761-Q1 have the following surge ratings (8/20  $\mu\text{s}$  waveform): 4.3A, 2.8 A, and 1.8 A, respectively. An ESD-surge clamp diverts this current to ground.

#### 7.3.2 IO Capacitance

The capacitance between the I/O pins of the ESD1LIN24-Q1, ESD751-Q1, and ESD761-Q1 devices are as follows: 2.3 pF, 1.6 pF, and 1.1 pF, respectively. The capacitance of these devices support data rates for LIN up to 10 Mbps.

### 7.3.3 Dynamic Resistance

The I/O pins feature an ESD clamp that have a low  $R_{DYN}$  of 0.48  $\Omega$  for the ESD1LIN24-Q1, 0.6  $\Omega$  for the ESD751-Q1, and 0.58  $\Omega$  for the ESD761-Q1.

### 7.3.4 DC Breakdown Voltage

The DC breakdown voltage between the I/O pins is a minimum of  $\pm 25.5$  V. This shields sensitive equipment from surges above the reverse standoff voltage of  $\pm 24$  V.

### 7.3.5 Ultra Low Leakage Current

The I/O pins feature an ultra-low leakage current of 50 nA (maximum) with a bias of  $\pm 24$  V.

### 7.3.6 Clamping Voltage

The I/O pins of the ESD1LIN24-Q1 feature an ESD clamp that is capable of clamping the voltage to 37 V ( $I_{PP} = 4.3$  A) and 37.7 V ( $I_{PP} = 16$  A for TLP). The I/O pins of the ESD751-Q1 feature an ESD clamp that is capable of clamping the voltage to 36.5 V ( $I_{PP} = 2.8$  A) and 39.7 V ( $I_{PP} = 16$  A for TLP). The I/O pins of the ESD761-Q1 feature an ESD clamp that is capable of clamping the voltage to 36.3 V ( $I_{PP} = 1.8$  A) and 39.3 V ( $I_{PP} = 16$  A for TLP).

### 7.3.7 Industry Standard Packages

The ESD1LIN24-Q1 and ESD751-Q1 feature industry standard SOD-323 (DYF) and SOD-523 (DYA) leaded packages for automatic optical inspection (AOI). The ESD761-Q1 is offered in the leadless X1SON (DPY) package

## 7.4 Device Functional Modes

The ESD1LIN24-Q1, ESD751-Q1, and ESD761-Q1 are single channel passive clamps that have low leakage during normal operation when the voltage between I/O and GND is below  $V_{RWM}$ , and activate when the voltage between I/O and GND goes above  $V_{BR}$ . During ISO 10605 ESD events, transient voltages from  $\pm 30$  kV to  $\pm 15$  kV can be clamped on either channel. When the voltages on the protected lines fall below the  $V_{HOLD}$ , the device reverts back to the low leakage passive state

## 8 Application and Implementation

### Note

Information in the following applications sections is not part of the TI component specification, and TI does not warrant its accuracy or completeness. TI's customers are responsible for determining suitability of components for their purposes, as well as validating and testing their design implementation to confirm system functionality.

### 8.1 Application Information

The ESD1LIN24-Q1, ESD751-Q1, and ESD761-Q1 are single channel TVS diodes which are used to provide a path to ground for dissipating ESD events on LIN signal lines. The LIN signal lines are typically routed throughout the automobile to connect between the different ECUs. As the current from ESD passes through the TVS, only a small voltage drop is present across the diode. This is the voltage presented to the protected IC. The low  $R_{DYN}$  of the triggered TVS holds this voltage,  $V_{CLAMP}$ , to a safe level for the protected IC.

### 8.2 Typical Application

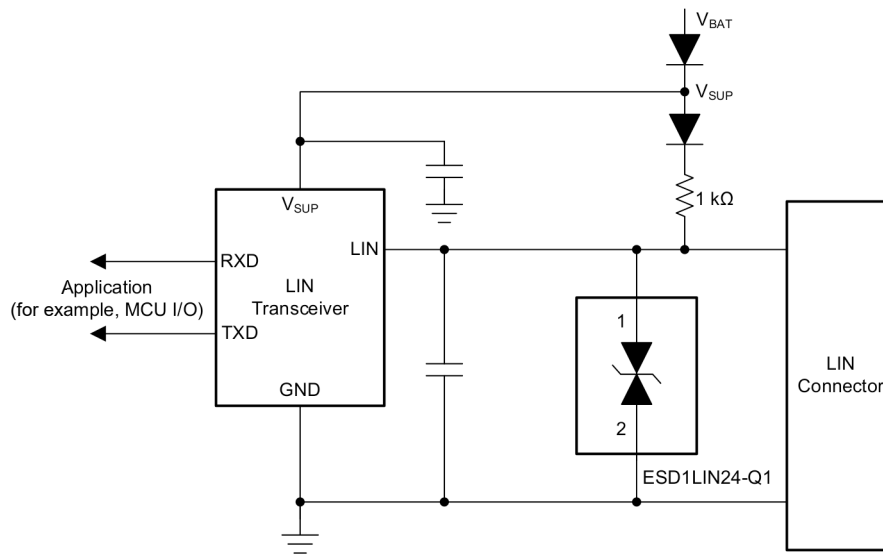

Figure 8-1. Typical Application

#### 8.2.1 Design Requirements

For this design example, the ESD1LIN24-Q1 is used to provide ESD protection to a LIN transceiver. The parameters listed in Table 8-1 are the known design parameters for this application.

Table 8-1. Design Parameters for Typical Applications

Design Parameter	Value
Diode configuration	Bidirectional
$V_{IO}$ signal range	Up to 18 V
$V_{RWM}$	$\pm 24$ V
Jumpstart short to battery event on $V_{IO}$	$\pm 24$ V
Data rate	Up to 10 Mbps
Pullup resistor	1 k $\Omega$

## 8.2.2 Detailed Design Procedure

The ESD1LIN24-Q1, ESD751-Q1, and ESD761-Q1 have a  $V_{RWM}$  of  $\pm 24$  V to protect the diode from being damaged during a short to battery event that can occur by reversing the terminal connections during jumpstart. The bidirectional characteristic ensures both positive and negative polarity are protected. The low capacitance of 5 pF or less permits data rates up to 10 Mbps, which allows the designer to meet the requirements for LIN. The 1 k $\Omega$  and VSUP diode allows the LIN signal to be pulled up to a diode drop below the battery voltage.

## 8.2.3 Application Curves

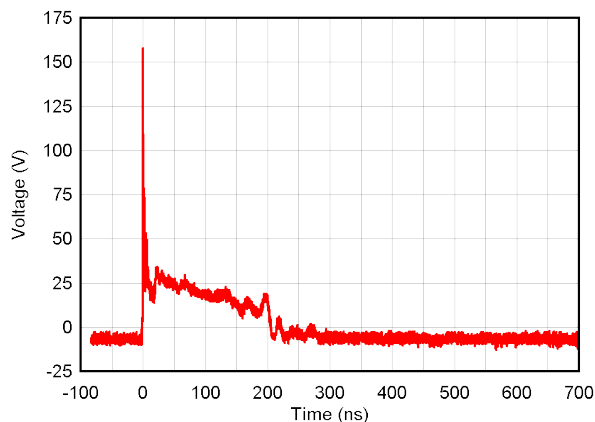

Figure 8-2. +8-kV Clamped IEC Waveform

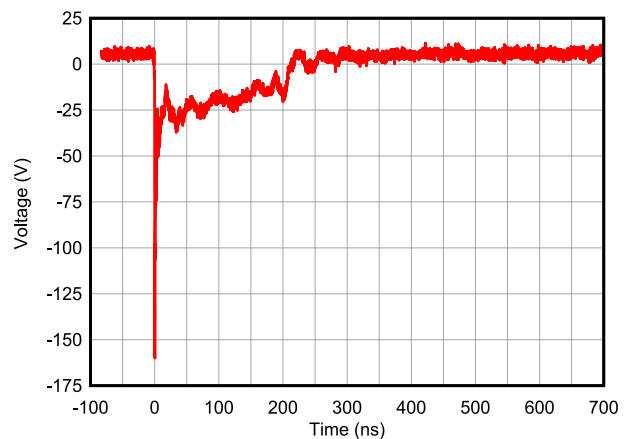

Figure 8-3. -8-kV Clamped IEC Waveform

## 9 Power Supply Recommendations

This device is a passive TVS diode-based ESD protection device, therefore there is no requirement to power it. Ensure that the maximum voltage specifications for each pin is not violated.

## 10 Layout

### 10.1 Layout Guidelines

- The optimum placement is as close to the connector as possible.
  - EMI during an ESD event can couple from the trace being struck to other nearby unprotected traces, resulting in early system failures.
  - The PCB designer must minimize the possibility of EMI coupling by keeping any unprotected traces away from the protected traces which are between the TVS and the connector.
- Route the protected traces as straight as possible.
- Eliminate any sharp corners on the protected traces between the TVS and the connector by using rounded corners with the largest radii possible.
  - Electric fields tend to build up on corners, increasing EMI coupling.
- If pin 1 or 2 is connected to ground, use a thick and short trace for this return path.

## 10.2 Layout Example

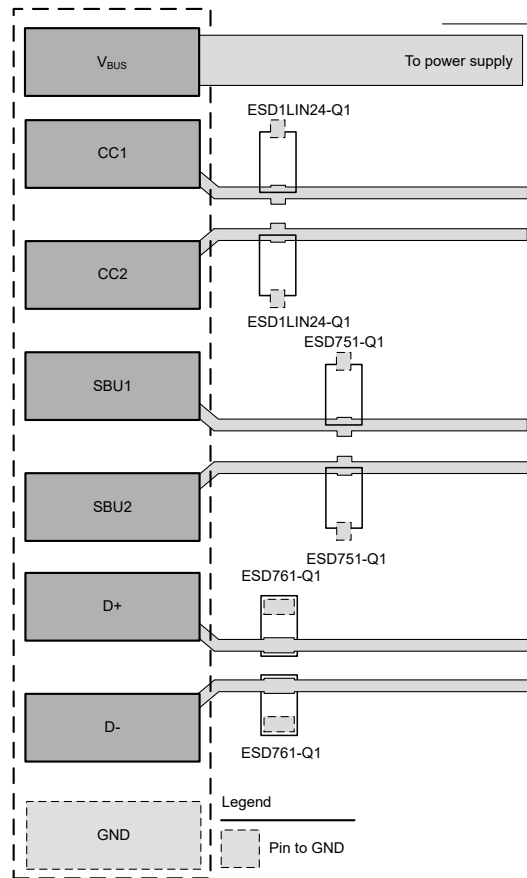

**Figure 10-1. Layout Recommendation**

## 11 Device and Documentation Support

TI offers an extensive line of development tools. Tools and software to evaluate the performance of the device, generate code, and develop solutions are listed below.

### 11.1 Documentation Support

#### 11.1.1 Related Documentation

For related documentation, see the following:

- Texas Instruments, [ESD Layout Guide application reports](#)
- Texas Instruments, [Generic ESD Evaluation Module user's guide](#)
- Texas Instruments, [Picking ESD Diodes for Ultra High-Speed Data Lines application reports](#)
- Texas Instruments, [Reading and Understanding an ESD Protection data sheet](#)

#### 11.2 Receiving Notification of Documentation Updates

To receive notification of documentation updates, navigate to the device product folder on [ti.com](#). Click on *Subscribe to updates* to register and receive a weekly digest of any product information that has changed. For change details, review the revision history included in any revised document.

#### 11.3 Support Resources

[TI E2E™ support forums](#) are an engineer's go-to source for fast, verified answers and design help — straight from the experts. Search existing answers or ask your own question to get the quick design help you need.

Linked content is provided "AS IS" by the respective contributors. They do not constitute TI specifications and do not necessarily reflect TI's views; see TI's [Terms of Use](#).

#### 11.4 Trademarks

TI E2E™ is a trademark of Texas Instruments.

All trademarks are the property of their respective owners.

#### 11.5 Electrostatic Discharge Caution



This integrated circuit can be damaged by ESD. Texas Instruments recommends that all integrated circuits be handled with appropriate precautions. Failure to observe proper handling and installation procedures can cause damage.

ESD damage can range from subtle performance degradation to complete device failure. Precision integrated circuits may be more susceptible to damage because very small parametric changes could cause the device not to meet its published specifications.

#### 11.6 Glossary

[TI Glossary](#) This glossary lists and explains terms, acronyms, and definitions.

## 12 Mechanical, Packaging, and Orderable Information

The following pages include mechanical, packaging, and orderable information. This information is the most current data available for the designated devices. This data is subject to change without notice and revision of this document. For browser-based versions of this data sheet, refer to the left-hand navigation.

**PACKAGING INFORMATION**

Orderable Device	Status (1)	Package Type	Package Drawing	Pins	Package Qty	Eco Plan (2)	Lead finish/ Ball material (6)	MSL Peak Temp (3)	Op Temp (°C)	Device Marking (4/5)	Samples
ESD1LIN24DYFRQ1	ACTIVE	SOT	DYF	2	3000	RoHS & Green	SN	Level-3-260C-168 HR	-55 to 150	2QKF	<a href="#">Samples</a>
ESD751DYARQ1	ACTIVE	SOT-5X3	DYA	2	8000	RoHS & Green	SN	Level-3-260C-168 HR	-55 to 150	1MO	<a href="#">Samples</a>
ESD761DPYRQ1	ACTIVE	X1SON	DPY	2	10000	RoHS & Green	NIPDAUAG	Level-1-260C-UNLIM	-55 to 150	NF	<a href="#">Samples</a>

(1) The marketing status values are defined as follows:

**ACTIVE:** Product device recommended for new designs.

**LIFEBUY:** TI has announced that the device will be discontinued, and a lifetime-buy period is in effect.

**NRND:** Not recommended for new designs. Device is in production to support existing customers, but TI does not recommend using this part in a new design.

**PREVIEW:** Device has been announced but is not in production. Samples may or may not be available.

**OBSOLETE:** TI has discontinued the production of the device.

(2) **RoHS:** TI defines "RoHS" to mean semiconductor products that are compliant with the current EU RoHS requirements for all 10 RoHS substances, including the requirement that RoHS substance do not exceed 0.1% by weight in homogeneous materials. Where designed to be soldered at high temperatures, "RoHS" products are suitable for use in specified lead-free processes. TI may reference these types of products as "Pb-Free".

**RoHS Exempt:** TI defines "RoHS Exempt" to mean products that contain lead but are compliant with EU RoHS pursuant to a specific EU RoHS exemption.

**Green:** TI defines "Green" to mean the content of Chlorine (Cl) and Bromine (Br) based flame retardants meet JS709B low halogen requirements of <=1000ppm threshold. Antimony trioxide based flame retardants must also meet the <=1000ppm threshold requirement.

(3) MSL, Peak Temp. - The Moisture Sensitivity Level rating according to the JEDEC industry standard classifications, and peak solder temperature.

(4) There may be additional marking, which relates to the logo, the lot trace code information, or the environmental category on the device.

(5) Multiple Device Markings will be inside parentheses. Only one Device Marking contained in parentheses and separated by a "-" will appear on a device. If a line is indented then it is a continuation of the previous line and the two combined represent the entire Device Marking for that device.

(6) Lead finish/Ball material - Orderable Devices may have multiple material finish options. Finish options are separated by a vertical ruled line. Lead finish/Ball material values may wrap to two lines if the finish value exceeds the maximum column width.

**Important Information and Disclaimer:**The information provided on this page represents TI's knowledge and belief as of the date that it is provided. TI bases its knowledge and belief on information provided by third parties, and makes no representation or warranty as to the accuracy of such information. Efforts are underway to better integrate information from third parties. TI has taken and continues to take reasonable steps to provide representative and accurate information but may not have conducted destructive testing or chemical analysis on incoming materials and chemicals. TI and TI suppliers consider certain information to be proprietary, and thus CAS numbers and other limited information may not be available for release.



In no event shall TI's liability arising out of such information exceed the total purchase price of the TI part(s) at issue in this document sold by TI to Customer on an annual basis.

**OTHER QUALIFIED VERSIONS OF ESD1LIN24-Q1, ESD751-Q1, ESD761-Q1 :**

- Catalog : [ESD1LIN24](#), [ESD751](#), [ESD761](#)

NOTE: Qualified Version Definitions:

- Catalog - TI's standard catalog product

**TAPE AND REEL INFORMATION**

**QUADRANT ASSIGNMENTS FOR PIN 1 ORIENTATION IN TAPE**

\*All dimensions are nominal

Device	Package Type	Package Drawing	Pins	SPQ	Reel Diameter (mm)	Reel Width W1 (mm)	A0 (mm)	B0 (mm)	K0 (mm)	P1 (mm)	W (mm)	Pin1 Quadrant
ESD1LIN24DYFRQ1	SOT	DYF	2	3000	178.0	9.5	1.48	3.3	1.25	4.0	8.0	Q1
ESD751DYARQ1	SOT-5X3	DYA	2	8000	178.0	9.5	0.5	1.94	0.73	2.0	8.0	Q1
ESD761DPYRQ1	X1SON	DPY	2	10000	178.0	8.4	0.7	1.15	0.47	2.0	8.0	Q1

## TAPE AND REEL BOX DIMENSIONS



\*All dimensions are nominal

Device	Package Type	Package Drawing	Pins	SPQ	Length (mm)	Width (mm)	Height (mm)
ESD1LIN24DYFRQ1	SOT	DYF	2	3000	210.0	200.0	42.0
ESD751DYARQ1	SOT-5X3	DYA	2	8000	210.0	200.0	42.0
ESD761DPYRQ1	X1SON	DPY	2	10000	205.0	200.0	33.0

DPY (R-PX1SON-N2)

PLASTIC SMALL OUTLINE NO-LEAD

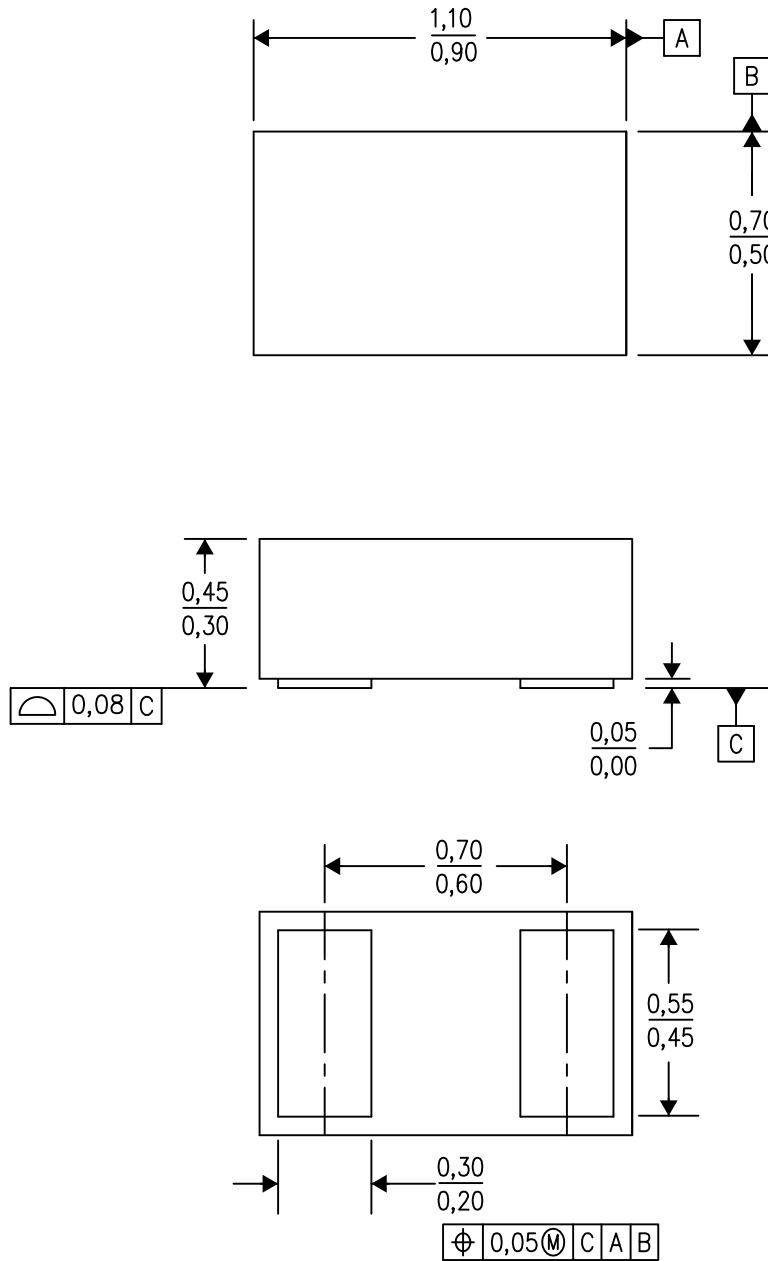

4211012/D 08/14

- NOTES:
- All linear dimensions are in millimeters. Dimensioning and tolerancing per ASME Y14.5-1994.
  - This drawing is subject to change without notice.
  - SON (Small Outline No-Lead) package configuration.

DPY0002A

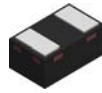

**PACKAGE OUTLINE**  
**X1SON - 0.45 mm max height**

PLASTIC SMALL OUTLINE - NO LEAD

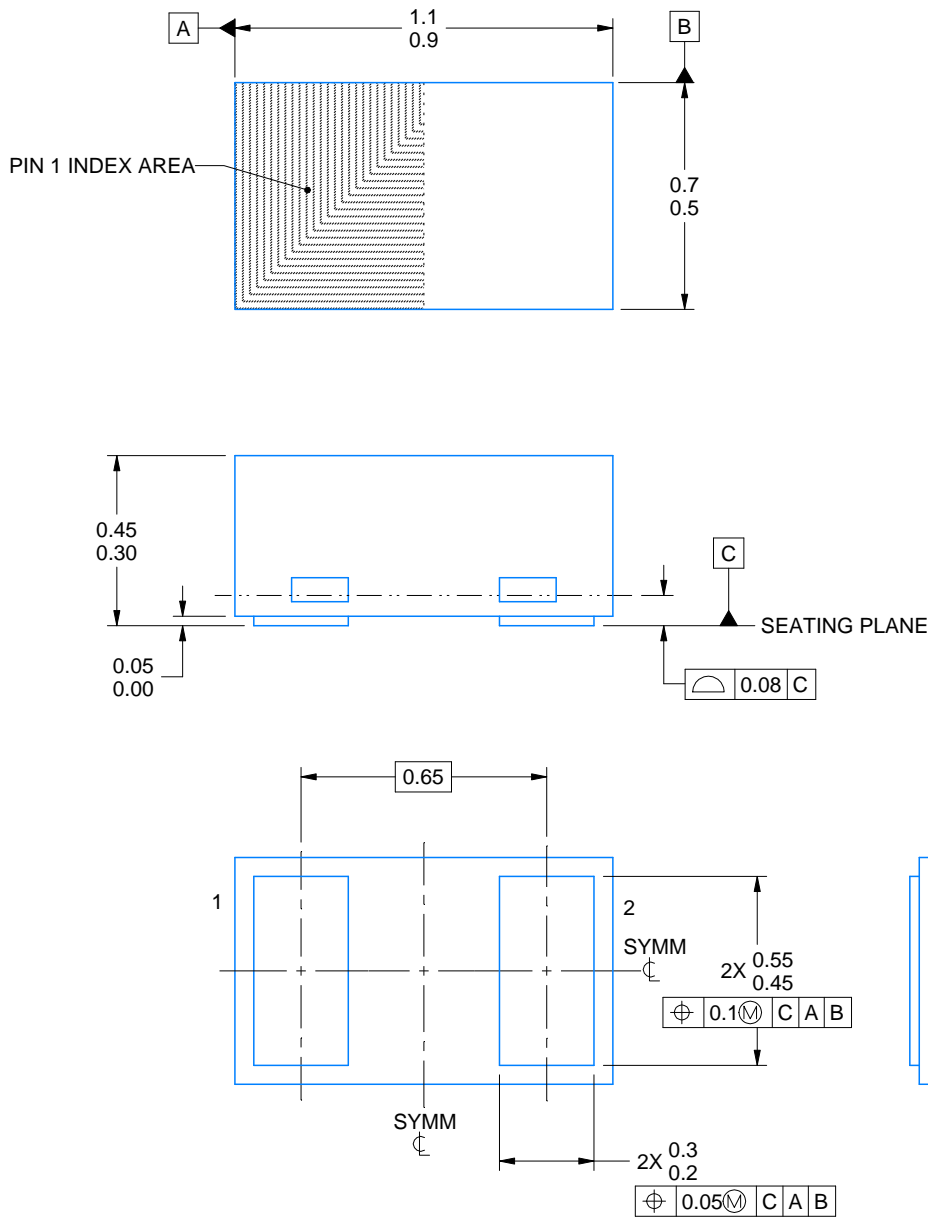

4224561/B 03/2021

NOTES:

1. All linear dimensions are in millimeters. Any dimensions in parenthesis are for reference only. Dimensioning and tolerancing per ASME Y14.5M
2. This drawing is subject to change without notice.

# EXAMPLE BOARD LAYOUT

DPY0002A

X1SON - 0.45 mm max height

PLASTIC SMALL OUTLINE - NO LEAD

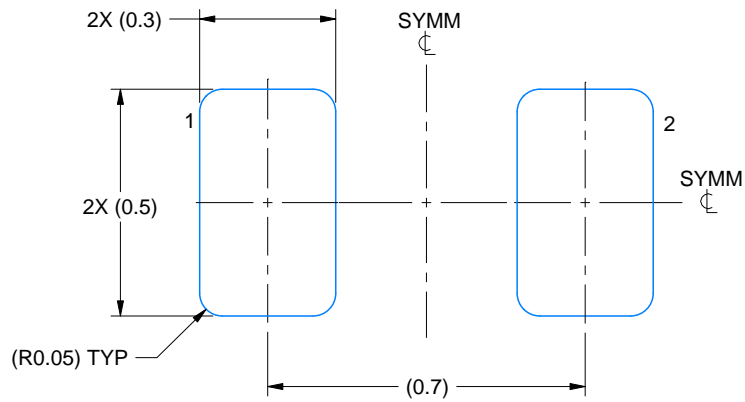

LAND PATTERN EXAMPLE  
EXPOSED METAL SHOWN  
SCALE:60X

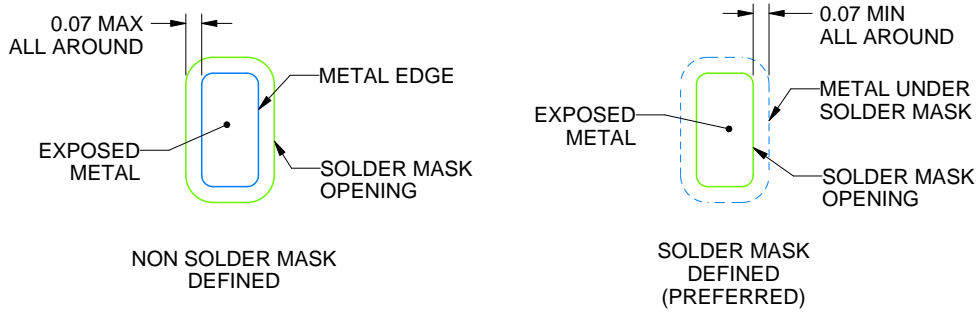

SOLDER MASK DETAILS

4224561/B 03/2021

NOTES: (continued)

3. For more information, see Texas Instruments literature number SLUA271 ([www.ti.com/lit/slue271](http://www.ti.com/lit/slue271)).
4. Vias are optional depending on application, refer to device data sheet. If any vias are implemented, refer to their locations shown on this view. It is recommended that vias under paste be filled, plugged or tented.

# EXAMPLE STENCIL DESIGN

DPY0002A

X1SON - 0.45 mm max height

PLASTIC SMALL OUTLINE - NO LEAD

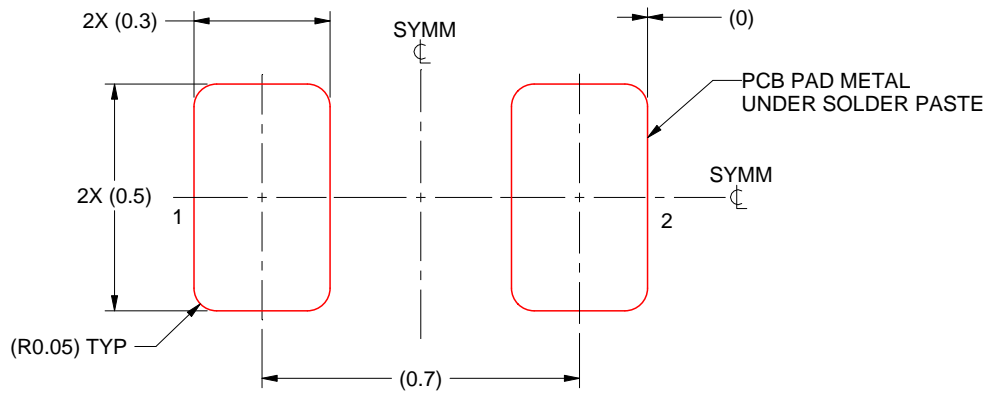

SOLDER PASTE EXAMPLE  
BASED ON 0.1 mm THICK STENCIL  
SCALE:60X

4224561/B 03/2021

NOTES: (continued)

5. Laser cutting apertures with trapezoidal walls and rounded corners may offer better paste release. IPC-7525 may have alternate design recommendations.

DYA0002A



# PACKAGE OUTLINE

SOT (SOD-523) - 0.77 mm max height

PLASTIC SMALL OUTLINE

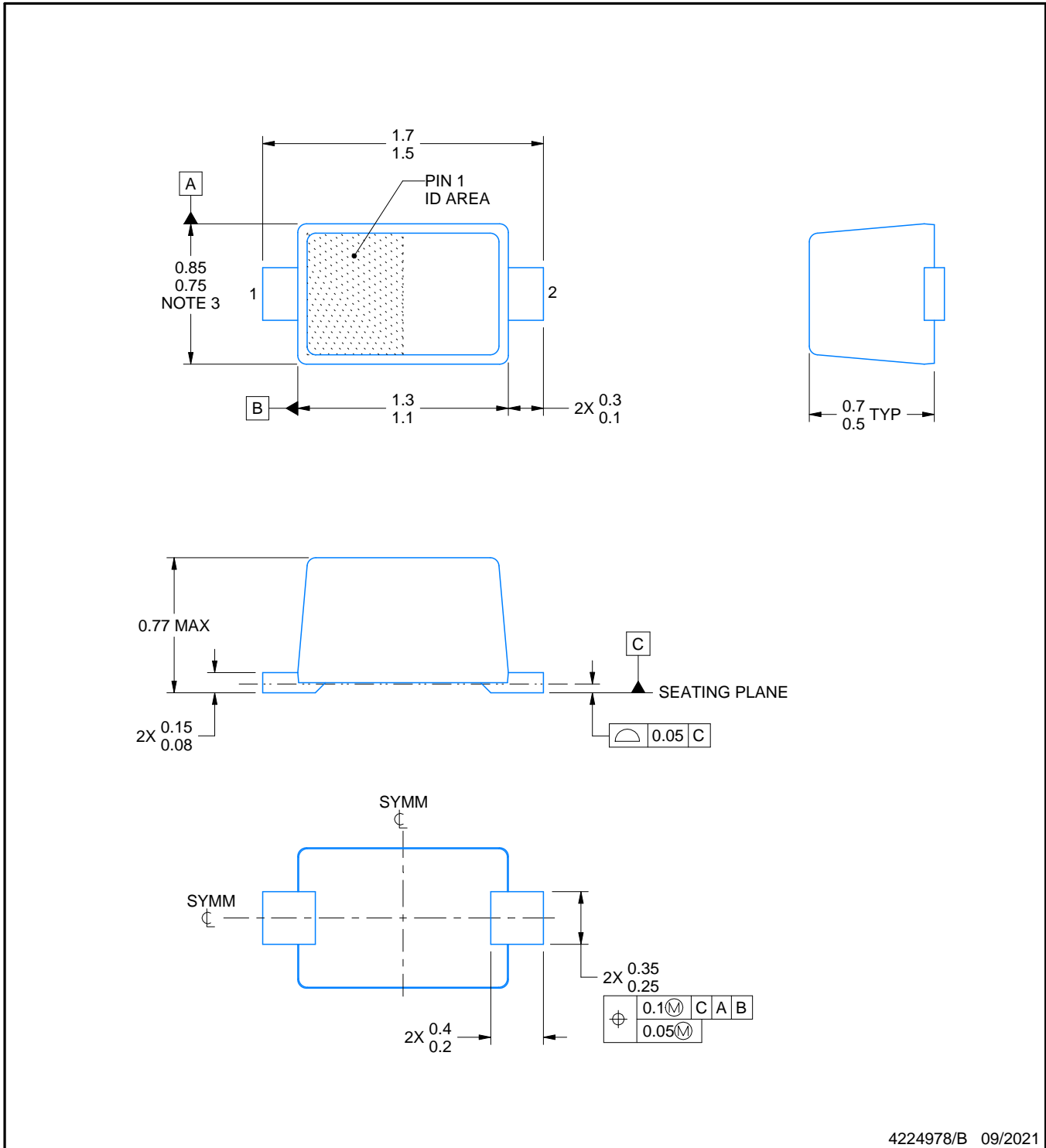

4224978/B 09/2021

## NOTES:

1. All linear dimensions are in millimeters. Any dimensions in parenthesis are for reference only. Dimensioning and tolerancing per ASME Y14.5M.
2. This drawing is subject to change without notice.
3. This dimension does not include mold flash, protrusions, or gate burrs. Mold flash, protrusions, or gate burrs shall not exceed 0.15 mm per side.
4. Reference JEITA SC-79 registration except for package height



# EXAMPLE BOARD LAYOUT

DYA0002A

SOT (SOD-523) - 0.77 mm max height

PLASTIC SMALL OUTLINE

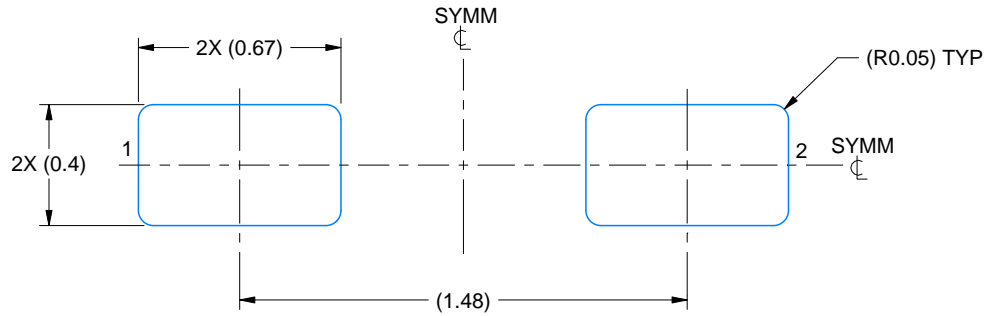

LAND PATTERN EXAMPLE  
SCALE:40X

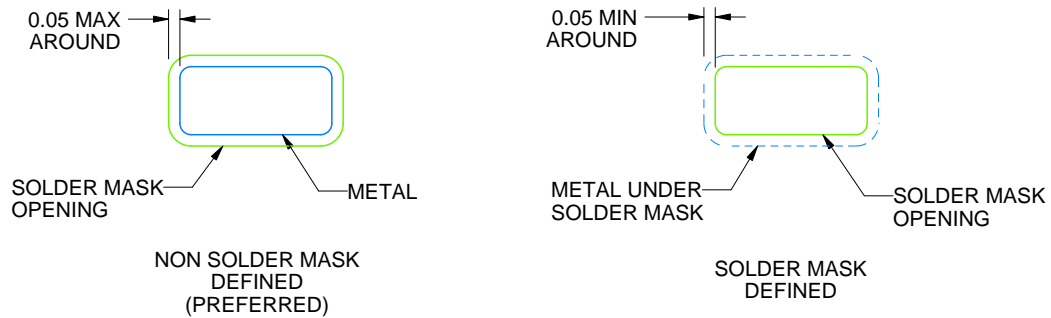

SOLDEMASK DETAILS

4224978/B 09/2021

NOTES: (continued)

- 5. Publication IPC-7351 may have alternate designs.
- 6. Solder mask tolerances between and around signal pads can vary based on board fabrication site.

# EXAMPLE STENCIL DESIGN

DYA0002A

SOT (SOD-523) - 0.77 mm max height

PLASTIC SMALL OUTLINE

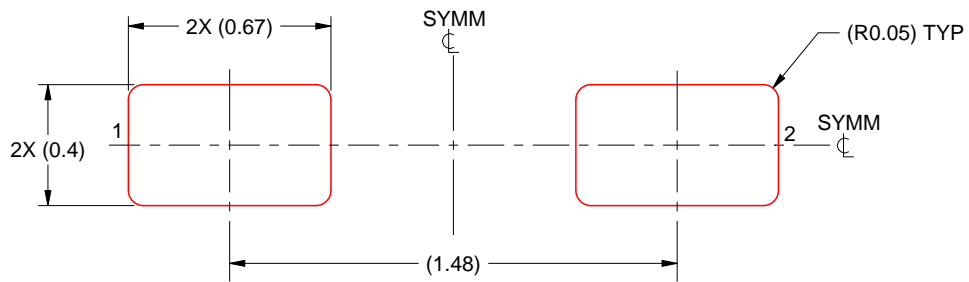

SOLDER PASTE EXAMPLE  
BASED ON 0.1 mm THICK STENCIL  
SCALE:40X

4224978/B 09/2021

NOTES: (continued)

7. Laser cutting apertures with trapezoidal walls and rounded corners may offer better paste release. IPC-7525 may have alternate design recommendations.
8. Board assembly site may have different recommendations for stencil design.

DYF0002A



PACKAGE OUTLINE

SOT(SOD-323) - 1 mm max height

SMALL OUTLINE TRANSISTOR

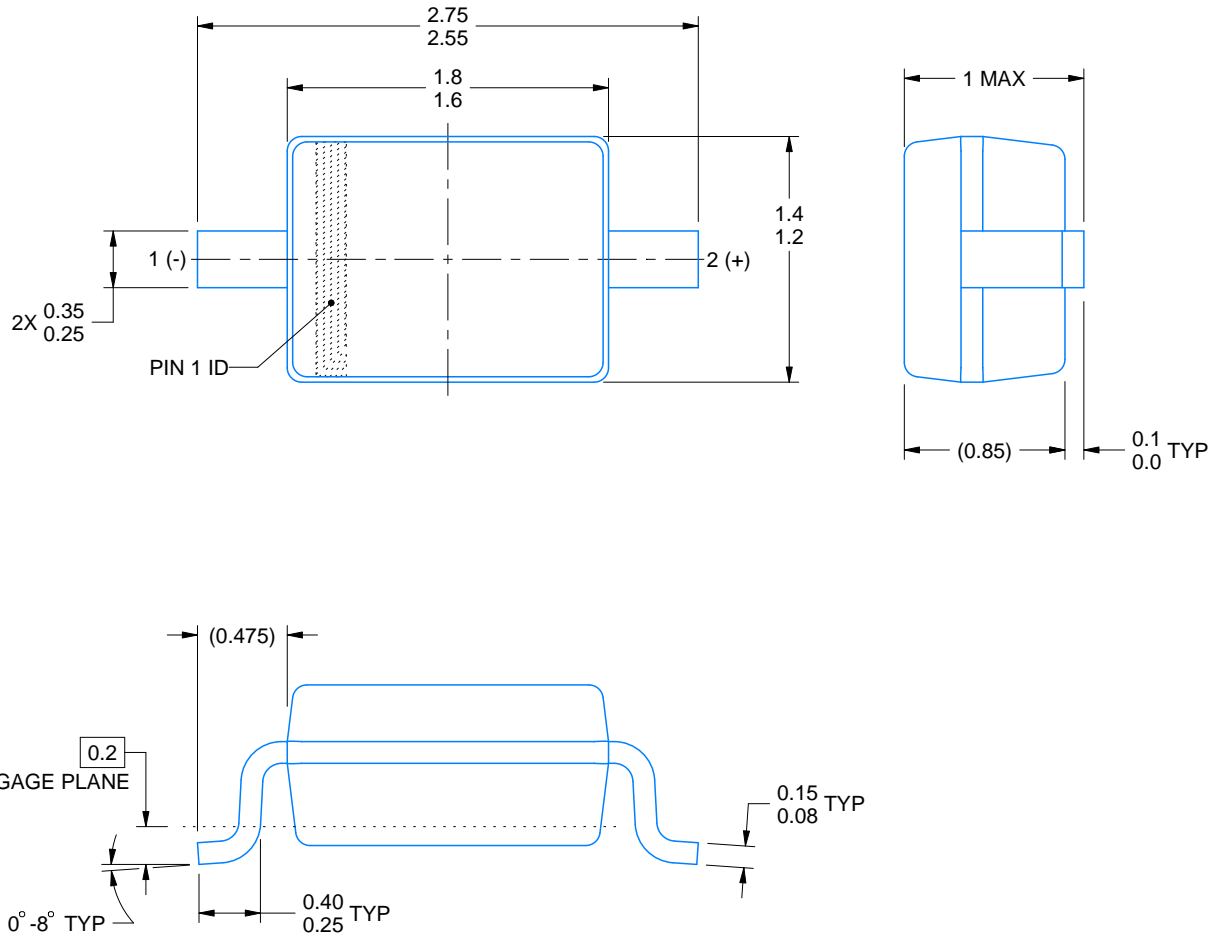

4228484/A 02/2022

NOTES:

1. All linear dimensions are in millimeters. Any dimensions in parenthesis are for reference only. Dimensioning and tolerancing per ASME Y14.5M.
2. This drawing is subject to change without notice.

# EXAMPLE BOARD LAYOUT

DYF0002A

SOT(SOD-323) - 1 mm max height

SMALL OUTLINE TRANSISTOR

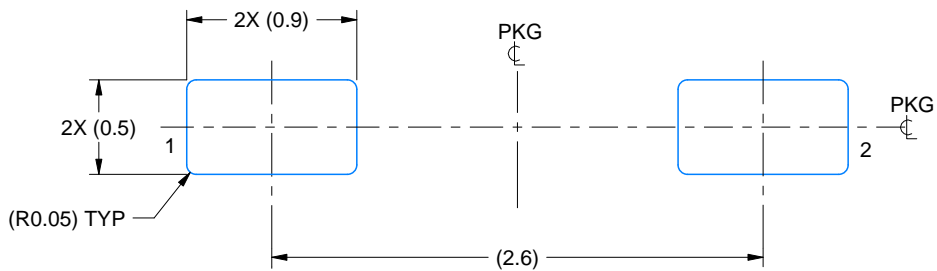

LAND PATTERN EXAMPLE  
EXPOSED METAL SHOWN  
SCALE:25X

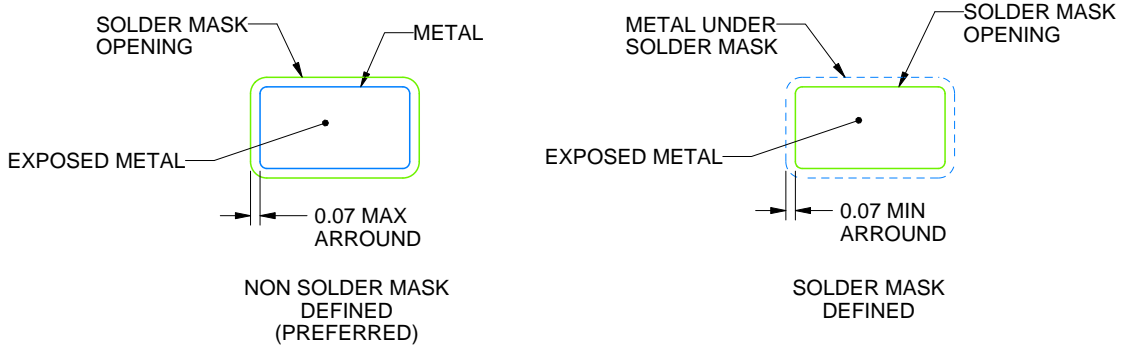

SOLDER MASK DETAILS

4228484/A 02/2022

NOTES: (continued)

- 3. Publication IPC-7351 may have alternate designs.
- 4. Solder mask tolerances between and around signal pads can vary based on board fabrication site.

# EXAMPLE STENCIL DESIGN

DYF0002A

SOT(SOD-323) - 1 mm max height

SMALL OUTLINE TRANSISTOR

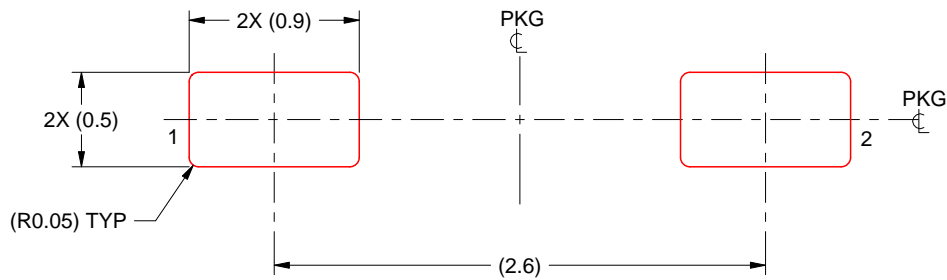

SOLDER PASTE EXAMPLE  
BASED ON 0.125 mm THICK STENCIL  
SCALE:25X

4228484/A 02/2022

NOTES: (continued)

5. Laser cutting apertures with trapezoidal walls and rounded corners may offer better paste release. IPC-7525 may have alternate design recommendations.
6. Board assembly site may have different recommendations for stencil design.

## IMPORTANT NOTICE AND DISCLAIMER

TI PROVIDES TECHNICAL AND RELIABILITY DATA (INCLUDING DATA SHEETS), DESIGN RESOURCES (INCLUDING REFERENCE DESIGNS), APPLICATION OR OTHER DESIGN ADVICE, WEB TOOLS, SAFETY INFORMATION, AND OTHER RESOURCES "AS IS" AND WITH ALL FAULTS, AND DISCLAIMS ALL WARRANTIES, EXPRESS AND IMPLIED, INCLUDING WITHOUT LIMITATION ANY IMPLIED WARRANTIES OF MERCHANTABILITY, FITNESS FOR A PARTICULAR PURPOSE OR NON-INFRINGEMENT OF THIRD PARTY INTELLECTUAL PROPERTY RIGHTS.

These resources are intended for skilled developers designing with TI products. You are solely responsible for (1) selecting the appropriate TI products for your application, (2) designing, validating and testing your application, and (3) ensuring your application meets applicable standards, and any other safety, security, regulatory or other requirements.

These resources are subject to change without notice. TI grants you permission to use these resources only for development of an application that uses the TI products described in the resource. Other reproduction and display of these resources is prohibited. No license is granted to any other TI intellectual property right or to any third party intellectual property right. TI disclaims responsibility for, and you will fully indemnify TI and its representatives against, any claims, damages, costs, losses, and liabilities arising out of your use of these resources.

TI's products are provided subject to [TI's Terms of Sale](#) or other applicable terms available either on [ti.com](https://www.ti.com) or provided in conjunction with such TI products. TI's provision of these resources does not expand or otherwise alter TI's applicable warranties or warranty disclaimers for TI products.

TI objects to and rejects any additional or different terms you may have proposed.

Mailing Address: Texas Instruments, Post Office Box 655303, Dallas, Texas 75265  
Copyright © 2023, Texas Instruments Incorporated