

ALS30A474QT040

Aliases (A331UW474M040A)

ALS30, Aluminum Electrolytic, 470,000 uF, 20%, 40 VDC, -40/+85°C

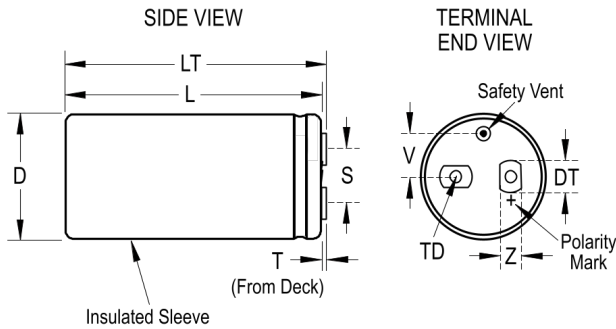

Click [here](#) for the 3D model.

Dimensions

D	90mm +/-1mm
L	220mm +/-2mm
T	5.5mm +/-0.5mm
S	31.8mm +/-0.5mm
DT	13mm +/-0.5mm
LT	223.5mm +/-1mm
TD	10mm MIN
V	25mm NOM
Z	10mm NOM

Packaging Specifications

Sleeving	Yes
Packaging	Bulk, Box

General Information

Series	ALS30
Dielectric	Aluminum Electrolytic
Description	Screw Terminal, Aluminum Electrolytic
RoHS	Yes
AEC-Q200	No
Component Weight	2000 g
Notes	Dimensions D And L Include Sleeving. MS (MxH) = M12x16. Mounting Clamp (Sold Separately): V90N
Shelf Life	156 Weeks

Specifications

Capacitance	470,000 uF
Capacitance Tolerance	20%
Voltage DC	40 VDC, 46 VDC (Surge)
Temperature Range	-40/+85°C
Rated Temperature	85°C
Life	20000 Hrs (Rated Voltage And Ripple Current At 85C), 40000 Hrs (Rated Voltage At 85C)
Resistance	4 mOhms (100Hz 20C), 4 mOhms (10kHz 20C)
Ripple Current	52.3 Amps (100Hz 85C), 53.4 Amps (10kHz 85C)
Leakage Current	6000 uA (5min 20°C)