

Amplifier and Standard Linear Selection Guide

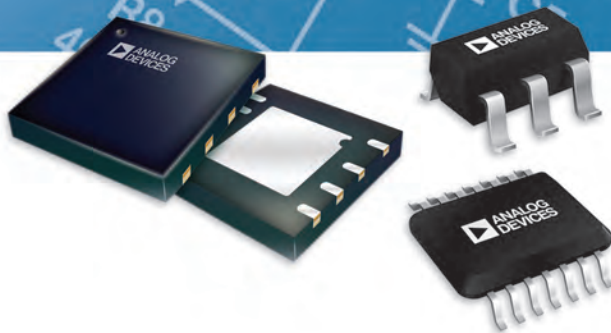
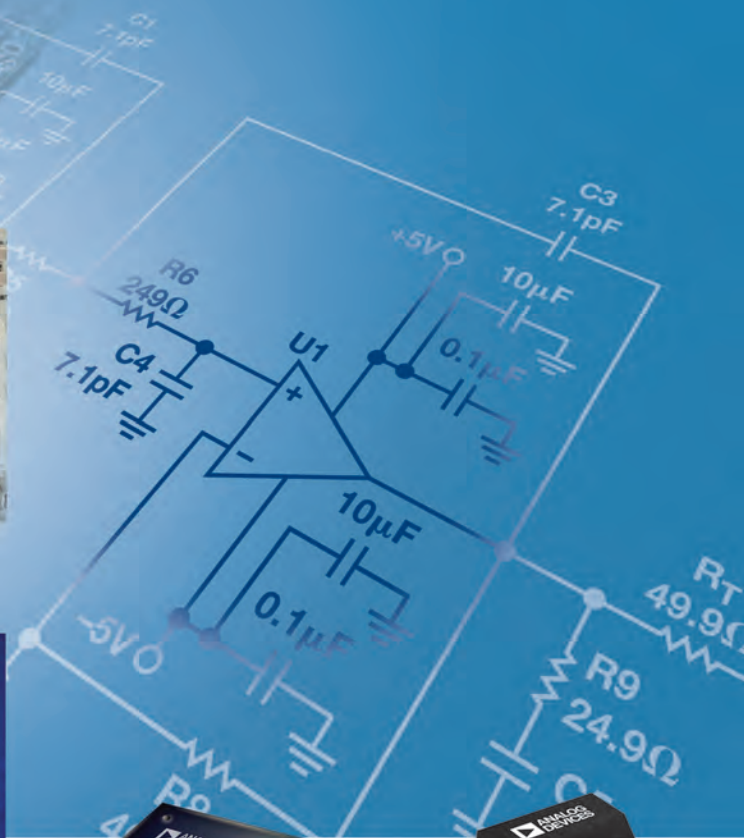
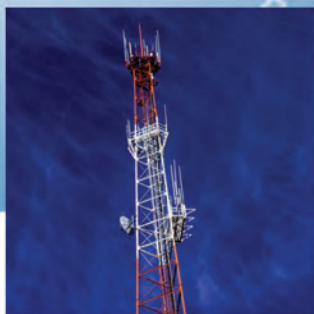

Simplify Op Amp and Standard Linear Selection for Your Applications

Selecting an amplifier is no easy task. With so many different amplifier types, architectures, and parameters to choose from, the process can be daunting. With Analog Devices' broad product portfolio and the information in this selection guide, we aim to simplify the process of finding the right amplifier for your application.

Following our highly sought after Operational Amplifier Selection Guide, we've expanded and added new product information and design resources for instrumentation, current sense, difference, variable gain amplifiers, and precision voltage references. This selection guide is now your go-to source for navigating ADI's amplifier and voltage reference product offerings.

Inside, you'll find our latest products highlighted for different amplifier and voltage reference categories, detachable product quick-search charts,

selection tables with detail specifications, and amplifiers for specialty applications. We also include information and links for ADI's evaluation tools, reference designs, and a very popular and quite useful "Commonly Used Amplifier Configurations" detachable wall chart at the end of this selection guide.

Our strong product portfolio, combined with leading technical expertise and customer support, is the reason many of you have partnered with us for your linear needs. ADI's engineers continue to develop new products with innovative technologies. For our most up to date offerings of amplifiers and other linear products, and to access additional information, please visit www.analog.com/amplifiers.

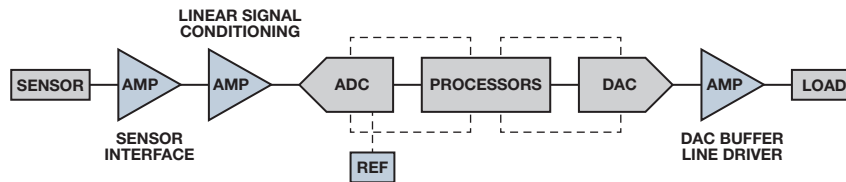

Contents

Quick Selection Guide (Detachable)

High Speed Operational Amplifiers	4	Instrumentation Amplifiers	38–40
Precision Operational Amplifiers	5–6	Current Sense Amplifiers	41
Instrumentation, Difference, Current Sense, and Variable Gain Amplifiers	7	Difference Amplifiers.....	42
Precision Voltage References.....	8	Variable Gain Amplifiers.....	43–44

Precision Amplifiers Selection Guide

($V_{os} < 1\text{ mV}$, Bandwidth $< 50\text{ MHz}$)

Zero-Drift	9	Voltage References	
Zero Input Crossover Distortion (ZCO)	10	Series Mode	45–47
Overvoltage Protection (OVP)	11	Shunt Mode	48
High Voltage ($> 44\text{ V}$)	12	ADC Drivers	49
Ultralow Offset Voltage	13–14	Amplifier and Standard Linear Products for Special Applications	
Low Offset Voltage	15	Automotive Grade Products.....	50–52
Low Power	16–17	Defense Qualified Products	53
Low Noise	18–19	Aerospace Qualified Products	54–55
Low Input Bias Current.....	20–21	High-Temperature Products	56
Single-Supply and Rail-to-Rail Output	22–24	Enhanced Products (EP)	57
Rail-to-Rail Input/Output.....	25–26	Die Products	58–59
Low Cost.....	27–28	Design Resources	60

High Speed Amplifiers Selection Guide (BW $> 50\text{ MHz}$)

Differential	29	Tools	61–66
Low Noise/Low Distortion.....	30	Design Equation (Detachable).....	67–72
Low Cost.....	31	Packaging Configurations	73–74
Rail-to-Rail Input/Output.....	32	Glossary	
FET Input—FastFET™	33	Operational Amplifiers	75
Current Feedback.....	34	Amplifier Design Technology.....	76
High Output Current	35	Amplifier Process and Trim Technology.....	77
High Supply Voltage ($\geq 12\text{ V}$)	36		
Clamping	37		

Quick Selection Guide for High Speed Operational Amplifiers (BW > 50 MHz)

High Speed Op Amps				
Differential Amplifiers				
Single	Dual			
ADA4927-1	ADA4927-2			
ADA4930-1	ADA4930-2			
ADA4932-1	ADA4932-2			
ADA4937-1	ADA4937-2			
ADA4938-1	ADA4938-2			
ADA4939-1	ADA4939-2			
ADA4940-1	ADA4940-2			
ADA4950-1	ADA4950-2			
ADA4922-1				
ADA4941-1				
ADA4960-1				
AD8131				
AD8132				
AD8137				
AD8138				
AD8139				
Differential Amplifier Receivers				
Single				
AD8129				
AD8130				
Low Noise, Low Distortion				
<1 nV	<2 nV	<3 nV	<6 nV	
AD8099	ADA4899-1	ADA4841-1	AD8048	
	ADA4898-1	ADA4841-2	AD8047	
	ADA4898-2	AD8021	ADA4857-1	
	ADA4896-2	AD8022 (Dual)	ADA4857-2	
	ADA4897-1	AD8045		
	ADA4897-2			
Rail-To-Rail				
Rail-to-Rail In/Out				
Single	Dual	Quad		
AD8031	AD8032			
AD8027	AD8028			
AD8029	AD8030	AD8040		
Rail-to-Rail Out				
Single	Dual	Triple	Quad	
ADA4805-1				
ADA4853-1	ADA4853-2	ADA4853-3		
ADA4850-1	ADA4850-2	ADA4855-3		
AD8091	AD8092	ADA4856-3		
AD8051	AD8052		AD8054	
AD8041	AD8042		AD8044	
Low Cost (<\$1/Channel)				
Single	Dual	Triple	Quad	
ADA4851-1	AD4851-2		ADA4851-4	
AD8038	AD8039			
AD8061	AD8062			
AD8063				
AD8055	AD8056			
AD8057	AD8058			
ADA4891-1	ADA4891-2	ADA4891-3	ADA4891-4	
FastFET				
Single	Dual			
ADA4817-1	ADA4817-2			
AD8033	AD8034			
AD8065	AD8066			
AD8067				
Current Feedback (5 V to 10 V)				
Low Cost (<\$1/Channel)				
Single	Dual	Triple		
ADA4860-1		ADA4861-3		
AD8014		ADA4862-3		
	AD8072	AD8073		
High Performance				
Single	Dual	Triple	Quad	
ADA4870				
AD8000	AD8002*	AD8003	AD8004	
AD8001*	AD8008	AD8013		
AD8005	AD8017	AD8023		
AD8007	ADA4310-1			
AD8009				
AD8011				
*10 V only.				
With Charge Pump				
		Triple		
		ADA4858-3		
		ADA4859-3		
High Supply Voltage (± 15 V)				
Single	Dual			
ADA4870				
ADA4898-1	ADA4898-2			
AD818	AD828			
AD847	AD827			
AD817	AD826			
AD829				
AD844*				
* ± 18 V				
High Current Output (>300 mA)				
Single	Dual		Quad	
ADA4870				
AD8390	AD8397		AD8392	
Fixed Gain (G = 2)				
Single		Triple		
AD8079		AD8075		
		ADA4862-3		
		ADA4856-3		
		ADA4859-3		
		ADA8074*		
*G = 1				
Adjustable Clamp Amplifiers				
Single				
AD8036				
AD8037				

Quick Selection Guide for Precision Operational Amplifiers (BW < 50 MHz)—Mid to High Voltage

Precision Op Amps—High Operating Voltage ($V_{ov} > 44V$)

Single	Dual	Quad	Spec
ADA4700-1			100V operating

Precision Op Amps—High Voltage (5 V to 44 V)

Ultraprecision

$V_{os} < 20 \mu V$

Single	Dual	Quad	Spec
ADA4638-1			5 μV , zero drift
AD8638	AD8639		10 μV , zero drift

$V_{os} < 100 \mu V$

Single	Dual	Quad	Spec
ADA4077-1	ADA4077-2	ADA4077-4	25 μV
	AD8676		50 μV
AD8671	AD8672	AD8674	75 μV
AD8675			75 μV

$V_{os} < 300 \mu V$

Single	Dual	Quad	Spec
ADA4084-1 ¹	ADA4084-2	ADA4084-4	100 μV
AD8610	AD8620		100 μV , JFET
AD8597	AD8599		120 μV
	AD8622	AD8624	125 μV
AD8677			130 μV
ADA4004-1	ADA4004-2	ADA4004-4	140 μV
AD8661	AD8662	AD8664	160 μV
ADA4627-1			200 μV , JFET
ADA4637-1			200 μV , JFET
	ADA4091-2	ADA4091-4	250 μV
	ADA4096-2		250 μV , input overvoltage
AD8663	AD8667	AD8669	300 μV

Low Power (I_{sT})

$I_{sT} < 100 \mu A$

Single	Dual	Quad	Spec
	OP281	OP481	5 μA
	AD8657		22 μA
	AD8546	AD8548 ¹	22 μA
	ADA4096-2		50 μA , input overvoltage

$I_{sT} < 500 \mu A$

Single	Dual	Quad	Spec
	AD8622	AD8624	200 μA
	ADA4091-2	ADA4091-4	200 μA
	ADA4062-2	ADA4062-4	220 μA
		ADA4092-4	225 μA
	AD8682	AD8684	250 μA
AD8663	AD8667	AD8669	285 μA
AD8641	AD8642	AD8644	290 μA
	ADA4665-2		400 μA
ADA4077-1	ADA4077-2	ADA4077-4	450 μA

$I_{sT} < 1 mA$

Single	Dual	Quad	Spec
AD820	AD822	AD824	700 μA
ADA4084-1 ¹	ADA4084-2	ADA4084-4	750 μA
AD8627	AD8626	AD8625	785 μA
AD8565	AD8566	AD8567	850 μA

$I_{sT} < 2 mA$

Single	Dual	Quad	Spec
AD8638	AD8639		1.5 mA, zero drift
ADA4610-1 ¹	ADA4610-2	ADA4610-4 ¹	1.7 mA
ADA4004-1	ADA4004-2	ADA4004-4	2 mA

Low Noise¹

Voltage Noise (e_n)— $e_n < 3 nV/\sqrt{Hz}$

Single	Dual	Quad	Spec
AD8597	AD8599		1 nV/ \sqrt{Hz}
ADA4004-1	ADA4004-2	ADA4004-4	1.8 nV/ \sqrt{Hz}
AD8675	AD8676		2.8 nV/ \sqrt{Hz}
AD8671	AD8672	AD8674	2.8 nV/ \sqrt{Hz}
	ADA4075-2		2.8 nV/ \sqrt{Hz}

Voltage Noise (e_n)— $e_n < 8 nV/\sqrt{Hz}$

Single	Dual	Quad	Spec
ADA4084-1 ¹	ADA4084-2	ADA4084-4	3.9 nV/ \sqrt{Hz}
ADA4627-1			6.1 nV/ \sqrt{Hz}
ADA4637-1			6.1 nV/ \sqrt{Hz}
ADA4077-1	ADA4077-2	ADA4077-4	7 nV/ \sqrt{Hz}
ADA4610-1 ¹	ADA4610-2	ADA4610-4 ¹	7.3 nV/ \sqrt{Hz}
	ADA4001-2		7.7 nV/ \sqrt{Hz}

Voltage Noise (e_n)— $e_n < 20 nV/\sqrt{Hz}$

Single	Dual	Quad	Spec
AD8661	AD8662	AD8664	10 nV/ \sqrt{Hz}
AD8665	AD8666	AD8668	10 nV/ \sqrt{Hz}
AD8677			10 nV/ \sqrt{Hz}
	AD8622	AD8624	11 nV/ \sqrt{Hz}
ADA4000-1	ADA4000-2	ADA4000-4	16 nV/ \sqrt{Hz}
AD8627	AD8626	AD8625	16 nV/ \sqrt{Hz}
AD820	AD822	AD824	16 nV/ \sqrt{Hz} , JFET

Current Noise (i_n); $i_n < 0.4 pA/\sqrt{Hz}$

Single	Dual	Quad	Spec
AD8641			0.0005 pA/ \sqrt{Hz}
ADA4627-1			0.0016 pA/ \sqrt{Hz}
ADA4637-1			0.0016 pA/ \sqrt{Hz}
	ADA4062-2	ADA4062-4	0.005 pA/ \sqrt{Hz}
AD820	AD822	AD824	0.008 pA/ \sqrt{Hz}
	AD8682	AD8684	0.01 pA/ \sqrt{Hz}
ADA4000-1	ADA4000-2	ADA4000-4	0.01 pA/ \sqrt{Hz}
AD8663	AD8667	AD8669	0.05 pA/ \sqrt{Hz}
AD8677			0.074 pA/ \sqrt{Hz}
AD8661	AD8662	AD8664	0.1 pA/ \sqrt{Hz}
AD8665	AD8666	AD8668	0.1 pA/ \sqrt{Hz}
	ADA4096-2	ADA4096-4	0.2 pA/ \sqrt{Hz}
ADA4077-1	ADA4077-2	ADA4077-4	0.2 pA/ \sqrt{Hz}
AD8675	AD8676		0.3 pA/ \sqrt{Hz}
AD8671	AD8672	AD8674	0.3 pA/ \sqrt{Hz}

JFET Input

Single	Dual	Quad
ADA4627-1		
ADA4637-1		
ADA4610-1 ¹	ADA4610-2	ADA4610-4 ¹
	ADA4001-2	
ADA4000-1	ADA4000-2	ADA4000-4
	ADA4062-2	ADA4062-4
AD8510	AD8512	AD8513
AD8610	AD8620	
AD8627	AD8626	AD8625
AD8641	AD8642	AD8644
AD8682	AD8682	AD8684
AD820	AD822	AD824

Low Bias Current ($I_b < 5 pA$)

Single	Dual	Quad	Spec
AD549			60 fA
AD8663	AD8667	AD8669	300 fA
AD8661	AD8662	AD8664	1 pA
AD8665	AD8666	AD8668	1 pA
AD8627	AD8626	AD8625	1 pA
AD8641	AD8642	AD8644	1 pA
AD820	AD822	AD824	1 pA
	ADA4665-2		1 pA
	ADA4661-2		3 pA
	ADA4666-2		3 pA
ADA4627-1			5 pA
ADA4637-1			5 pA

¹ Prerelease

² See application note AN-940, *Low Noise Amplifier Selection Guide for Optimal Noise Performance* www.analog.com/AN-940

Quick Selection Guide for Precision Operational Amplifiers (BW < 50 MHz)—Low Voltage

Precision Op Amps—Low Voltage (1.8 V to 6 V)

Precision (V_{os})

$V_{os} < 20 \mu\text{V}$ (Auto-Zero)

Single	Dual	Quad	Spec
ADA4825-1	ADA4528-2		2.5 μV , zero drift
AD8628	AD8629	AD8630	5 μV , zero drift
AD8551	AD8552	AD8554	5 μV , zero drift
AD8571	AD8572	AD8574	5 μV , zero drift
AD8538	AD8539		13 μV , zero drift
ADA4051-1	ADA4051-2		15 μV , zero drift

$V_{os} < 400 \mu\text{V}$

Single	Dual	Quad	Spec
AD8603	AD8607	AD8609	50 μV
AD8615	AD8616	AD8618	65 μV
AD8655	AD8656		250 μV , 0.4 $\mu\text{V}/^\circ\text{C}$
AD8605	AD8606	AD8608	300 μV , 1 $\mu\text{V}/^\circ\text{C}$
AD8651	AD8652		350 μV , 4 $\mu\text{V}/^\circ\text{C}$

$V_{os} < 1 \text{ mV}$

Single	Dual	Quad	Spec
AD8601	AD8602	AD8604	500 μV , 2 $\mu\text{V}/^\circ\text{C}$
AD8500			1000 μV , 3.5 $\mu\text{V}/^\circ\text{C}$

Low Power (I_{sV})

$I_{sV} < 20 \mu\text{A}$

Single	Dual	Quad	Spec
AD8500	AD8502	AD8504	1 μA
ADA4505-1	ADA4505-2	ADA4505-4	10 μA , zero crossover
ADA4051-1	ADA4051-2		17 μA , zero drift
AD8505	AD8506	AD8508	20 μA zero crossover

$I_{sV} < 100 \mu\text{A}$

Single	Dual	Quad	Spec
AD8613	AD8617	AD8619	40 μA
AD8603	AD8607	AD8609	40 μA
AD8541	AD8542	AD8544	55 μA , JFET input

$I_{sV} < 1 \text{ mA}$

Single	Dual	Quad	Spec
AD8538	AD8539		190 μA
	ADA4691-2	ADA4691-4	225 μA
	ADA4692-2	ADA4692-4	225 μA
AD8601	AD8602	AD8604	750 μA
AD8531	AD8532	AD8534	750 μA
AD8691	AD8692	AD8694	950 μA
AD8605	AD8606	AD8608	1000 μA
AD8628	AD8629	AD8630	1000 μA , zero drift

Low Bias Current ($I_b < 2 \text{ pA}$)

Single	Dual	Quad	Spec
AD8613	AD8617	AD8619	1 pA
AD8603	AD8607	AD8609	1 pA
AD8691	AD8692	AD8694	1 pA
AD8605	AD8606	AD8608	1 pA
AD8615	AD8616	AD8618	1 pA
	AD8646	AD8648	1 pA
	AD8647SD		1 pA
	ADA4500-2		1 pA
ADA4505-1	ADA4505-2	ADA4505-4	2 pA

Low Noise¹

Voltage Noise (e_n)— $e_n < 15 \text{ nV}/\sqrt{\text{Hz}}$

Single	Dual	Quad	Spec
AD8655	AD8656		2.7 $\text{nV}/\sqrt{\text{Hz}}$
AD8651	AD8652		4.5 $\text{nV}/\sqrt{\text{Hz}}$
ADA4528-1	ADA4528-2		5.9 $\text{nV}/\sqrt{\text{Hz}}$, zero drift
AD8615	AD8616	AD8618	8 $\text{nV}/\sqrt{\text{Hz}}$
AD8691	AD8692	AD8694	8 $\text{nV}/\sqrt{\text{Hz}}$
AD8605	AD8606	AD8608	8 $\text{nV}/\sqrt{\text{Hz}}$
	AD8646	AD8648	8 $\text{nV}/\sqrt{\text{Hz}}$
	ADA4691-2	ADA4691-4	16 $\text{nV}/\sqrt{\text{Hz}}$
	ADA4692-2	ADA4692-4	16 $\text{nV}/\sqrt{\text{Hz}}$

Voltage Noise (e_n)— $e_n < 50 \text{ nV}/\sqrt{\text{Hz}}$

Single	Dual	Quad	Spec
AD8628	AD8629	AD8630	22 $\text{nV}/\sqrt{\text{Hz}}$, zero drift
AD8515			22 $\text{nV}/\sqrt{\text{Hz}}$
AD8613	AD8617	AD8619	25 $\text{nV}/\sqrt{\text{Hz}}$
AD8601	AD8602	AD8604	33 $\text{nV}/\sqrt{\text{Hz}}$
AD8551	AD8552	AD8554	42 $\text{nV}/\sqrt{\text{Hz}}$, zero drift
AD8591	AD8592	AD8594	45 $\text{nV}/\sqrt{\text{Hz}}$
AD8531	AD8532	AD8534	45 $\text{nV}/\sqrt{\text{Hz}}$
AD8505	AD8506	AD8508	48 $\text{nV}/\sqrt{\text{Hz}}$, zero crossover

Voltage Noise (e_n)— $e_n > 50 \text{ nV}/\sqrt{\text{Hz}}$

Single	Dual	Quad	Spec
AD8538	AD8539		50 $\text{nV}/\sqrt{\text{Hz}}$
AD8571	AD8572	AD8574	51 $\text{nV}/\sqrt{\text{Hz}}$, zero drift
AD4505-1	AD4505-2	AD4505-4	60 $\text{nV}/\sqrt{\text{Hz}}$
ADA4051-1	ADA4051-2		95 $\text{nV}/\sqrt{\text{Hz}}$, zero drift
AD8500	AD8502	AD8504	190 $\text{nV}/\sqrt{\text{Hz}}$

Current Noise (i_n)— $i_n < 100 \text{ fA}/\sqrt{\text{Hz}}$

Single	Dual	Quad	Spec
AD8571	AD8572	AD8574	2 $\text{fA}/\sqrt{\text{Hz}}$, zero drift
AD8551	AD8552	AD8554	2 $\text{fA}/\sqrt{\text{Hz}}$, zero drift
AD8651	AD8652		4 $\text{fA}/\sqrt{\text{Hz}}$
AD8628	AD8629	AD8630	5 $\text{fA}/\sqrt{\text{Hz}}$, zero drift
AD8605	AD8606	AD8608	10 $\text{fA}/\sqrt{\text{Hz}}$
AD8515			50 $\text{fA}/\sqrt{\text{Hz}}$
AD8601	AD8602	AD8604	50 $\text{fA}/\sqrt{\text{Hz}}$
AD8613	AD8617	AD8619	50 $\text{fA}/\sqrt{\text{Hz}}$
AD8603	AD8607	AD8609	50 $\text{fA}/\sqrt{\text{Hz}}$
AD8691	AD8692	AD8694	50 $\text{fA}/\sqrt{\text{Hz}}$
AD8615	AD8616	AD8618	50 $\text{fA}/\sqrt{\text{Hz}}$
AD8591	AD8592	AD8594	50 $\text{fA}/\sqrt{\text{Hz}}$
AD8531	AD8532	AD8534	50 $\text{fA}/\sqrt{\text{Hz}}$
AD8505	AD8506	AD8508	80 $\text{fA}/\sqrt{\text{Hz}}$, zero crossover
ADA4051-1	ADA4051-2		100 $\text{fA}/\sqrt{\text{Hz}}$, zero drift
AD8500	AD8502	AD8504	100 $\text{fA}/\sqrt{\text{Hz}}$
ADA4505-1	ADA4505-2	ADA4505-4	100 $\text{fA}/\sqrt{\text{Hz}}$, zero crossover
AD8541	AD8542	AD8544	100 $\text{fA}/\sqrt{\text{Hz}}$

Instrumentation/Difference/Current Sense/Variable Gain Amplifier Quick Selection Guide

Instrumentation/Difference/Current Sense/Variable Gain Amplifiers

Instrumentation Amplifiers

General Purpose		
Single	Dual	Input Offset Voltage
AD8221	AD8222	25 μ V/60 μ V
AD8422		40 μ V
AD8295		60 μ V
AD8226	AD8426	100 μ V
AD8227		100 μ V
AD8290		
AD620		125 μ V
AD623		200 μ V
AD8223		250 μ V
AD8220	AD8224	250 μ V/300

Low Power ($I_{sv} < 100 \mu$ A)		
Single	Dual	Supply Current
AD8236		40 μ A
AD8235		40 μ A
AD8420		80 μ A
AD627		85 μ A

Low Noise ($e_n < 5 \text{ nV}/\sqrt{\text{Hz}}$)		
Single	Dual	Input Voltage Noise
AD8429		1 $\text{nV}/\sqrt{\text{Hz}}$
AD8428		1.5 $\text{nV}/\sqrt{\text{Hz}}$, fixed G = 2000
AD8421		3.2 $\text{nV}/\sqrt{\text{Hz}}$

Low Drift ($< 1 \mu\text{V}/^\circ\text{C}$)		
Single	Dual	Voltage Drift
AD8230		0.05 $\mu\text{V}/^\circ\text{C}$
AD8231		0.05 $\mu\text{V}/^\circ\text{C}$
AD8553		0.1 $\mu\text{V}/^\circ\text{C}$
AD8237		0.2 $\mu\text{V}/^\circ\text{C}$
AD8293G80/G160		0.3 $\mu\text{V}/^\circ\text{C}$, fixed gains
AD8228		0.8 $\mu\text{V}/^\circ\text{C}$, fixed gains

Programmable Gain		
Single	Dual	Gains
AD8231		1, 2, 4, 8, 16, 32, 64, 128
AD8250		1, 2, 5, 10
AD8251		1, 2, 4, 8
AD8253		1, 10, 100, 1000

Difference Amplifiers (Low Gain)

Low Distortion / High Speed		
Single	Dual	Gains
	AD8270	0.5, 1, 2
AD8271		0.5, 1, 2
AD8274	AD8273	0.5, 2
AD8276	AD8277	1
AD8278	AD8279	0.5, 2

High CM Voltage		
Single	Dual	Common-Mode Range
AD8479		$\pm 600 \text{ V}$
AD629		$\pm 270 \text{ V}$
AD628		$\pm 120 \text{ V}$

Low Power		
Single	Dual	Supply Current
AD8278	AD8279	200 μ A
AD8276	AD8277	220 μ A

Level Translation		
Single	Dual	Translate
AD8275		$\pm 10 \text{ V}$ to $+ 4 \text{ V}$
AD8475		$\pm 10 \text{ V}$ to $\pm 4 \text{ V}$ (diff)

Current Sense Amplifiers

Unidirectional		
Single	Dual	Offset Voltage Drift
AD8219		1 $\mu\text{V}/^\circ\text{C}$
AD8217		1 $\mu\text{V}/^\circ\text{C}$
AD8212		10 $\mu\text{V}/^\circ\text{C}$
AD8203		10 $\mu\text{V}/^\circ\text{C}$, high gain
AD8202		10 $\mu\text{V}/^\circ\text{C}$, high gain
AD8211	AD8213	12 $\mu\text{V}/^\circ\text{C}$
AD8215		18 $\mu\text{V}/^\circ\text{C}$
AD8209		20 $\mu\text{V}/^\circ\text{C}$, high gain
AD8208		20 $\mu\text{V}/^\circ\text{C}$, high gain

Bidirectional		
Single	Dual	Offset Voltage Drift
AD8417		0.4 $\mu\text{V}/^\circ\text{C}$
AD8418/A		1 $\mu\text{V}/^\circ\text{C}$
AD8218		1 $\mu\text{V}/^\circ\text{C}$
AD8207		1 $\mu\text{V}/^\circ\text{C}$
AD8210		8 $\mu\text{V}/^\circ\text{C}$
AD8216		20 $\mu\text{V}/^\circ\text{C}$, high gain
AD8206		15 $\mu\text{V}/^\circ\text{C}$ TYP, high gain
AD8205		15 $\mu\text{V}/^\circ\text{C}$ TYP, high gain

Threshold Detector		
Single	Dual	
AD8214		

Variable Gain Amplifiers

Analog Control			
Single	Dual	Quad	Gain Range
	AD600		0 dB to 40 dB
	AD602		-10 dB to +30 dB
AD603			-11 dB to +31 dB, 9 dB to 51 dB
	AD604		0 dB to 48 dB, 6 dB to 54 dB
AD605			-14 dB to +34 dB, 0 dB to 48 dB
		AD8264	0 dB to 24 dB
AD8330			-30 dB to +70 dB
AD8331			-5 dB to +43 dB, 7 dB to 55 dB
	AD8332	AD8334	-5 dB to +43 dB, 7 dB to 55 dB
		AD8335	-10 dB to +38 dB, -2 dB to +46 dB
AD8336			-14 dB to +46 dB, 0 dB to 60 dB
AD8337			0 dB to 24 dB
AD8338			0 dB to 80 dB
AD8340			-2 dB to -32 dB
AD8341			-4 dB to -34 dB
AD8367			-2.5 dB to +42.5 dB
AD8368			-12 dB to +22 dB
ADL5330			-34 dB to +22 dB
ADL5331			-15 dB to +15 dB
	ADL5336		-15 dB to +20 dB
	ADL5390		-27 dB to +5 dB
ADL5391			0 dB to -42 dB
	ADRF6510		-5 dB to +45 dB
	ADRF6516		-5 dB to +45 dB, analog and digital control
		ADRF6518	-36 dB to +66 dB, analog and digital control

Digital Control		
Single	Dual	Gain Range
AD8260		30 dB
	AD8366	4.5 dB to 20.5 dB
AD8369		-5 dB to +40 dB
AD8370		-11 dB to +17 dB, 6 dB to 34 dB
	AD8372	-9 dB to +32 dB
AD8375		-4 dB to +20 dB
	AD8376	-4 dB to +20 dB
ADL5201		-11.5 dB to +20 dB
	ADL5202	-11.5 dB to +20 dB
ADL5240		-13.5 dB to +18 dB
ADL5243		3.5 dB to 35 dB
ADL5592		60 dB

Digitally Controlled Line Drivers		
Single	Dual	Gain Range
AD8324		-25.5 dB to +33.5 dB
AD8325		-29.45 dB to +30 dB
ADA4320-1		-27 dB to +32 dB

Precision Voltage References Quick Selection Guide

Series Mode Precision Voltage References

Low Power

$I_{SV} < 100 \mu A$

ADR291/ADR292/ADR293	15 μA
REF191/REF192/REF193/REF194/ REF195/REF196/REF198	45 μA
AD1582/AD1583/AD1584/AD1585	70 μA
ADR3412/20/25/30/33/40/45	100 μA

$I_{SV} < 500 \mu A$

ADR127	125 μA
ADR380/ADR381, ADR391/ADR392	140 μA
ADR130	150 μA
ADR360/ADR361/ADR363/ ADR364/ADR365	190 μA
AD680, ADR827	280 μA
ADR287	400 μA

$I_{SV} < 1 mA$

ADR420/ADR421/ADR423/ADR425	600 μA
ADR430/ADR431/ADR433/ ADR434/ADR435	800 μA
ADR4520/ADR4525/ADR4530/ ADR4533/ADR4540/ADR4550	950 μA
ADR01/ADR02/ADR03/ADR06 AD581/AD584 AD780	1 mA

Ultraprecision

Tempco $\leq 5 ppm/^\circ C$

ADR4520/ADR4525/ADR4530/ ADR4533/ADR4540/ADR4550	2 ppm/ $^\circ C$
ADR430/ADR431/ADR433/ ADR434/ADR435	3 ppm/ $^\circ C$
ADR440/ADR441/ADR443/ ADR444/ADR445	3 ppm/ $^\circ C$
ADR01/ADR02/ADR03/ADR06	3 ppm/ $^\circ C$
AD581/AD584/AD586/AD588	5 ppm/ $^\circ C$
REF191/REF192/REF193/REF194/ REF195/REF196/REF198	5 ppm/ $^\circ C$

Tempco $\leq 10 ppm/^\circ C$

ADR3412/ADR3420/ADR3425/ ADR3430/ADR3433/ADR3440/ADR3445	8 ppm/ $^\circ C$
REF01/REF02	8.5 ppm/ $^\circ C$
ADR361/ADR363/ADR364/ADR366	9 ppm/ $^\circ C$
ADR391/ADR392/ADR395	9 ppm/ $^\circ C$
ADR291/ADR292	10 ppm/ $^\circ C$

Low Noise

Output Noise $\leq 5 \mu V_{p-p}$

ADR4520/ADR4525/ADR4530/ ADR4533/ADR4540/ADR4550	1 μV_{p-p} @ 2.048 V output
ADR440/ADR441/ADR443/ ADR444/ADR445	1 μV_{p-p} @ 2.048 V output
ADR420/ADR421/ADR423/ADR425	1.75 μV_{p-p} @ 2.048 V output
ADR130	3 μV_{p-p}
ADR430	3.5 μV_{p-p}
AD780	4 μV_{p-p}
AD587	4 μV_{p-p}
ADR380/ADR381	5 μV_{p-p}

Shunt Mode Precision Voltage References

AD589	10 ppm/ $^\circ C$
AD1580/AD1581	50 ppm/ $^\circ C$
ADR510/ADR512/ADR525/ ADR530/ADR550	70 ppm/ $^\circ C$, low noise
ADR5040/ADR5041/ADR5043/ ADR5044/ADR5045	75 ppm/ $^\circ C$
ADR1500	220 ppm/ $^\circ C$

Precision Amplifiers ($V_{OS} < 1 \text{ mV}$, Bandwidth $< 50 \text{ MHz}$)

Zero-Drift Amplifiers

ADA4528-1/ADA4528-2: Precision, Ultralow Noise, RRIO, Zero-Drift Operational Amplifiers

The ADA4528-1 (single) and ADA4528-2 (dual) are ultralow noise, zero-drift operational amplifiers featuring rail-to-rail input and output swing. With an offset voltage of $2.5 \mu\text{V}$, offset voltage drift of $0.015 \mu\text{V}/^\circ\text{C}$, and noise of 97 nV p-p (0.1 Hz to 10 Hz, $A_v = +100$), the device is well suited for applications in which error sources cannot be tolerated. With a wide operating supply range of 2.2 V to 5.5 V, high gain, and excellent CMRR and PSRR specifications, the ADA4528-x family is ideal for precision amplification of low level signals, such as those used in pressure sensors, strain gages, and medical instrumentation.

Features

- Low offset: $2.5 \mu\text{V}$ maximum
- Low offset voltage drift: $0.015 \mu\text{V}/^\circ\text{C}$ maximum
- Low noise
 - No 1/f noise
 - $5.6 \text{ nV}/\sqrt{\text{Hz}}$ at $f = 1 \text{ kHz}$, $A_v = +100$
 - 97 nV p-p at $f = 0.1 \text{ Hz}$ to 10 Hz , $A_v = +100$
- Open-loop voltage gain: 130 dB minimum
- CMRR: 135 dB minimum
- PSRR: 130 dB minimum
- Unity gain crossover: 4 MHz
- Single-supply operation: 2.2 V to 5.5 V
- Dual-supply operation: $\pm 1.1 \text{ V}$ to $\pm 2.75 \text{ V}$
- Rail-to-rail input and output
- Unity-gain stable

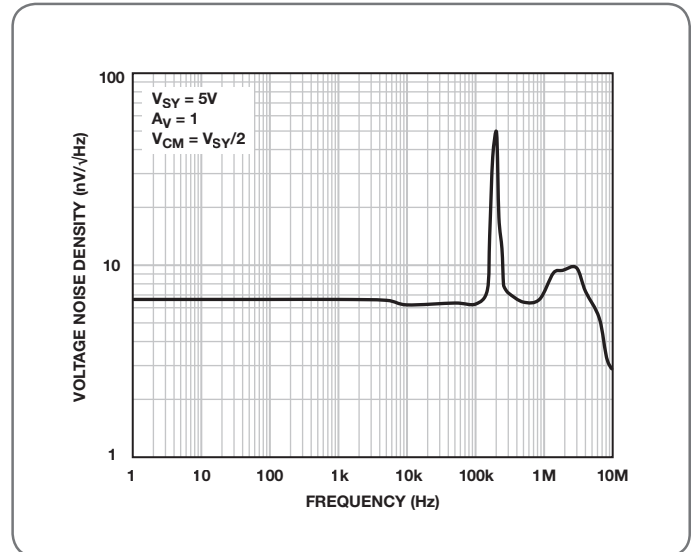

Voltage noise density vs. frequency.

Applications

- Thermocouples/thermopiles
- Load cell and bridge transducers
- Precision instrumentation
- Electronic scales
- Medical instrumentation
- Handheld test equipment

Zero-Drift Amplifiers

Process	Part Number	No. of Amps	Supply Voltage (VMin/Max)	Rail-to-Rail	BW @ A _{cl} Min (MHz)	Slew Rate (V/ μs)	V_{OS} Max (mV)	TcV_{OS} ($\mu\text{V}/^\circ\text{C}$ Typ)	CMRR Min (dB)	PSRR Min (dB)	A_{vo} Min (dB)	Noise ($\text{nV}/\sqrt{\text{Hz}}$) @ 1 kHz	I_S /Amp (mA Max)	I_B Max (pA)	Packaging	Price @ 1k (OEM \$US)
CMOS	AD8628	1	2.7/6	RRIO	2.5	1	0.005	0.002	120	115	125	22	0.850	100	SOT-23/SOIC	0.96
	AD8629	2													MSOP/SOIC	1.47
	AD8630	4													SOIC/TSSOP	2.73
CMOS	ADA4528-1	1	2.2/5.5	RRIO	4	0.4	0.0025	0.002	137	130	127	5.9	1.800	200	MSOP/LFCSP	0.98
	ADA4528-2	2														1.52
CMOS	ADA4051-1	1	1.8/5.5	RRIO	0.125	0.06	0.015	0.02	110	110	115	95	0.017	70	SC-70/SOT-23	0.93
	ADA4051-2	2													MSOP/LFCSP	1.47
CMOS	AD8538	1	2.7/5.5	RRIO	0.43	0.35	0.013	0.03	115	105	115	50	0.180	25	SOT-23/SOIC	0.50
	AD8539	2													MSOP/SOIC	0.72
CMOS	AD8551	1	2.7/6	RRIO	1.5	0.4	0.005	0.005	120	120	125	42	0.975	50	MSOP/SOIC	1.22
	AD8552	2													SOIC/TSSOP	1.94
	AD8554	4													SOIC/TSSOP	3.43
CMOS	AD8571	1	2.7/6	RRIO	1.5	0.4	0.005	0.005	120	120	125	51	0.850	50	MSOP/SOIC	1.11
	AD8572	2													SOIC/TSSOP	1.78
	AD8574	4													SOIC/TSSOP	3.40
CMOS	AD8638	1	5/16	SS	1.5	2	0.009	0.03	127	127	130	60	1.500	75	SOT-23/SOIC	1.08
	AD8639	2													MSOP/SOIC/LFCSP	1.89
iCMOS®	ADA4638-1	1	9/33	RRIO	1.5	1.5	0.0045	0.0125	130	120	140	66	1.050	90	SOIC/LFCSP	1.28

¹ RRIO: rail-to-rail input/output, RRO: rail-to-rail output, SS: single supply (IVR includes $-V_{S1}$).

Precision Amplifiers ($V_{OS} < 1 \text{ mV}$, Bandwidth $< 50 \text{ MHz}$)

Zero Input Crossover Distortion (ZCO) Amplifiers

ADA4500-2: 10 MHz, 10 MHz, 14.5 nV/ $\sqrt{\text{Hz}}$, RRIO, Zero Input Crossover Distortion Dual Amplifier

The ADA4500-2 is a dual 10 MHz, 14.5 nV/ $\sqrt{\text{Hz}}$, low power amplifier featuring rail-to-rail input and output swings while operating from a 2.7 V to 5.5 V single power supply. Employing a novel zero-crossover distortion circuit topology, this amplifier offers high linearity over the full, rail-to-rail input common-mode range, with excellent power supply rejection ratio (PSRR) and common-mode rejection ratio (CMRR) performance, without the crossover distortion seen with the traditional complementary rail-to-rail input stage. The resulting op amp also has excellent precision, wide bandwidth, and very low bias current.

Features

- Rail-to-rail input/output
- PSRR: 98 dB minimum
- CMRR: 95 dB minimum
- Offset voltage: 120 μV maximum
- 2.7 V to 5.5 V single-supply or $\pm 2.75 \text{ V}$ to $\pm 2.75 \text{ V}$ dual-supply operation
- Wide bandwidth: 10 MHz
- Low noise
 - 2 μV p-p from 0.1 Hz to 10 Hz
 - 14.5 nV/ $\sqrt{\text{Hz}}$ @ 1 kHz
- Low input bias current: 2 pA maximum

Applications

- Pressure and position sensors
- Remote security
- Medical monitors
- Process control
- Hazard detectors
- Photodiodes

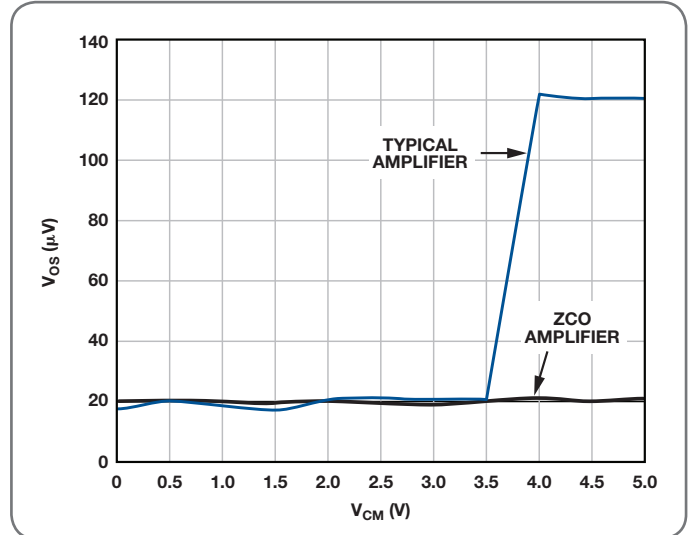

Input offset voltage vs. common-mode voltage.

Zero Input Crossover Distortion (ZCO) Amplifiers

Process	Part Number	No. of Amps	Supply Voltage (Min/Max)	Rail-to-Rail ¹	BW @ A _{CL} Min (MHz)	Slew Rate (V/ μs)	V _{OS} Max (mV)	TcV _{OS} ($\mu\text{V}/^\circ\text{C}$ Typ)	CMRR Min (dB)	PSRR Min (dB)	A _{VO} Min (dB)	Noise (nV/ $\sqrt{\text{Hz}}$) @ 1 kHz	I _S /Amp (mA Max)	I _B Max (pA)	Packaging	Price @ 1k (OEM \$US)
CMOS	ADA4505-1	1													Micro CSP/SOT-23	0.41
	ADA4505-2	2	1.8/5.5	RRIO	0.050	0.006	3	2	90	100	105	65	0.010	2	Micro CSP/MSOP	0.57
	ADA4505-4	4													Micro CSP/TSSOP	1.01
CMOS	AD8505	1														0.47
	AD8506	2	1.8/5.5	RRIO	0.095	0.013	2.5	2	90	100	105	45	0.020	10	Micro CSP/SOT-23	0.57
	AD8508	4													Micro CSP/TSSOP	1.02
LD20	ADA4500-2	2	2.7/5.5	RRIO	10	5.5	0.12	0.9	95	98	105	14.5	1.750	2	Micro CSP/MSOP	0.98

¹ RRIO: rail-to-rail input/output, RRO: rail-to-rail output, SS: single supply (IVR includes $-V_{SS}$).

Overvoltage Protection (OVP) Amplifiers

ADA4096-2/ADA4096-4: 30 V, Micropower, OVP, Rail-to-Rail Input/Output Operational Amplifiers

The ADA4096-2 dual and ADA4096-4 quad operational amplifiers feature micropower operation and rail-to-rail input and output ranges. The extremely low power requirements and guaranteed operation from 3 V to 30 V make these amplifiers perfectly suited to monitor battery usage and to control battery charging. The ADA4096 family features a unique input stage that allows the input voltage to exceed either supply safely without any phase reversal or latch-up; this is called overvoltage protection, or OVP.

Features

- Single-supply operation: 3 V to 30 V
- Rail-to-rail input and output swing
- Low supply current: 60 μ A/amplifier
- Low offset voltage: 300 μ V maximum
- Overvoltage protection (OVP), 32 V above and below the supply rails
- No phase reversal
- Unity-gain bandwidth
800 kHz typ @ $V_{SY} = \pm 15$ V
550 kHz typ @ $V_{SY} = \pm 5$ V
465 kHz typ @ $V_{SY} = \pm 1.5$ V

Applications

- Battery monitoring
- Sensor conditioners
- Portable power supply control
- Portable instrumentation

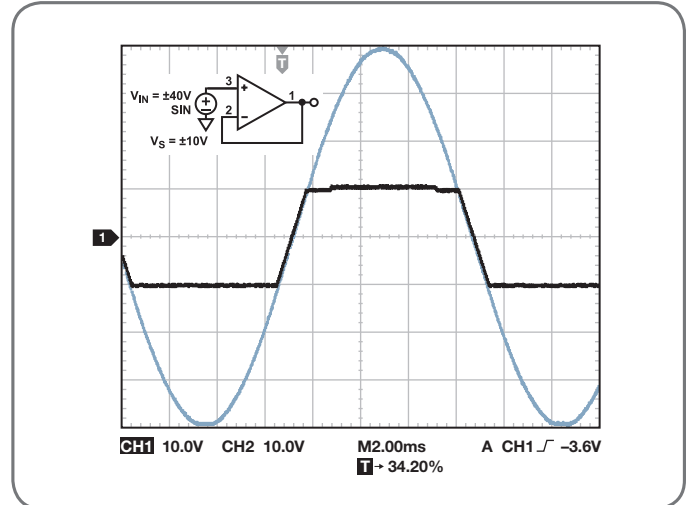

No phase reversal.

Overvoltage Protection (OVP) Amplifiers

Process	Part Number	No. of Amps	Supply Voltage (Min/Max)	Rail-to-Rail ¹	BW @ A _{cl} Min (MHz)	Slew Rate (V/ μ s)	V_{os} Max (mV)	T_cV_{os} (μ V/ $^{\circ}$ C Typ)	CMRR Min (dB)	PSRR Min (dB)	A_{v0} Min (dB)	Noise (nV/ \sqrt Hz) @ 1 kHz	I_s /Amp (mA Max)	OVP Level (V)	Packaging	Price @ 1k (OEM \$US)
Bipolar	OP191	1												10	SOIC	1.72
	OP291	2	2.7/12	RRIO	1.5	0.5	0.5	1.1	75	80	88	42	0.420	10	SOIC	2.22
	OP491	4												25	SOIC/TSSOP/PDIP	3.89
Bipolar	ADA4091-2	2	$\pm 1.35/\pm 18$	RRIO	1.27	0.46	0.25	2.5	104	108	116	25	0.250	12	SOIC/LFCSP	2.22
	ADA4091-4	4													LFCSP/TSSOP	3.60
Bipolar	ADA4092-4	4	$\pm 1.35/\pm 18$	RRIO	1.4	0.4	1.5	2.5	90	98	116	30	0.250	12	TSSOP	2.50
Bipolar	ADA4096-2	2	3.0/36	RRIO	0.8	0.4	0.3	1	82	100	110	27	0.075	32	LFCSP/MSOP	1.87
	ADA4096-4	4													LFCSP/TSSOP	2.70

¹ RRIO: rail-to-rail input/output, RRO: rail-to-rail output, SS: single supply (IVR includes $-V_{SY}$).

Precision Amplifiers ($V_{OS} < 1 \text{ mV}$, Bandwidth $< 50 \text{ MHz}$)

High Voltage Amplifier ($>44 \text{ V}$)

ADA4700-1: 100 V, Precision Operational Amplifier

The ADA4700-1 is a high voltage, precision, single-channel operational amplifier with a wide operating voltage range ($\pm 5 \text{ V}$ to $\pm 50 \text{ V}$) and relatively high output current drive. Its advanced design combines low power (170 mW for a $\pm 50 \text{ V}$ supply), high bandwidth (3.5 MHz), and a high slew rate with unity-gain stability and phase inversion free performance. The ability to swing near rail-to-rail at the output enables designers to maximize signal-to-noise ratios (SNRs).

Features

- Low input offset voltage: $\leq 0.2 \text{ mV}$ typical
- High output current drive: 30 mA
- Wide range of operating voltage: $\pm 5 \text{ V}$ to $\pm 50 \text{ V}$
- High slew rate: $20 \mu\text{V/s}$ typical
- High gain bandwidth product: 3.5 MHz typical
- Thermal regulation at junction temperature $> 145^\circ\text{C}$
- Ambient temperature range of -40°C to $+85^\circ\text{C}$
- Low input bias current: $\leq 15 \text{ nA}$ typical

Applications

- Automated and bench top test equipment
- High voltage regulators and power amplifiers
- Data acquisition and signal conditioning
- Piezo drivers and predrivers
- General-purpose current sensing

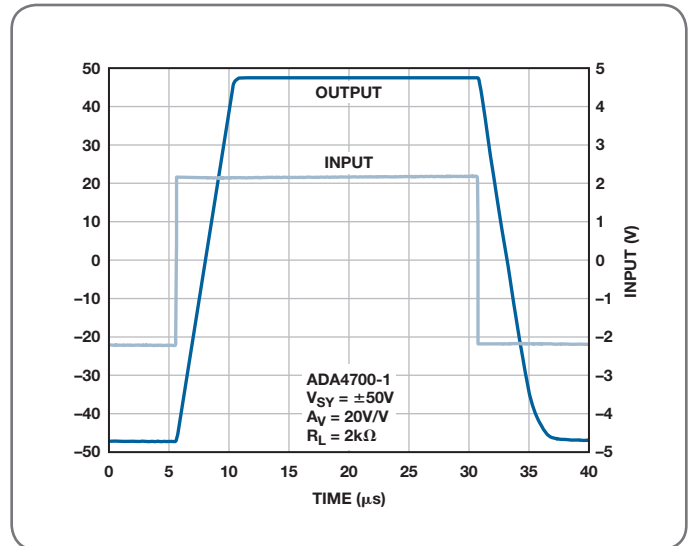

Slew rate.

Precision Amplifiers (Bandwidth < 50 MHz)

Ultralow Offset Voltage ($V_{OS} \leq 250 \mu\text{V Max}$) Amplifiers

ADA4638-1: -30 V Auto-Zero, Rail-to-Rail Output Precision Amplifier

The ADA4638-1 is a high precision, zero-drift amplifier featuring rail-to-rail output swing. It is guaranteed to operate from 4.5 V to 30 V single supply or $\pm 2.25 \text{ V}$ to $\pm 15 \text{ V}$ dual supplies while consuming less than 0.95 mA of supply current at $\pm 5 \text{ V}$. With an offset voltage of $4 \mu\text{V}$, offset drift less than $0.05 \mu\text{V}/^\circ\text{C}$, no 1/f noise, and input voltage noise of only $1.2 \mu\text{V p-p}$ (0.1 Hz to 10 Hz), the ADA4638-1 is suited for high precision applications where large error sources cannot be tolerated. Pressure sensors, medical equipment, and strain gage amplifiers benefit greatly from nearly zero drift over the wide operating temperature range.

Features

- Low offset voltage: $4 \mu\text{V}$ maximum
- Input offset voltage drift: $0.05 \mu\text{V}/^\circ\text{C}$ maximum
- High gain: 130 dB minimum
- High PSRR: 120 dB minimum
- High CMRR: 130 dB minimum
- Rail-to-rail output
- Low supply current: 0.95 mA maximum

Applications

- Electronic weigh scale
- Pressure and position sensors
- Strain gage amplifiers
- Medical instrumentation
- Thermocouple amplifiers

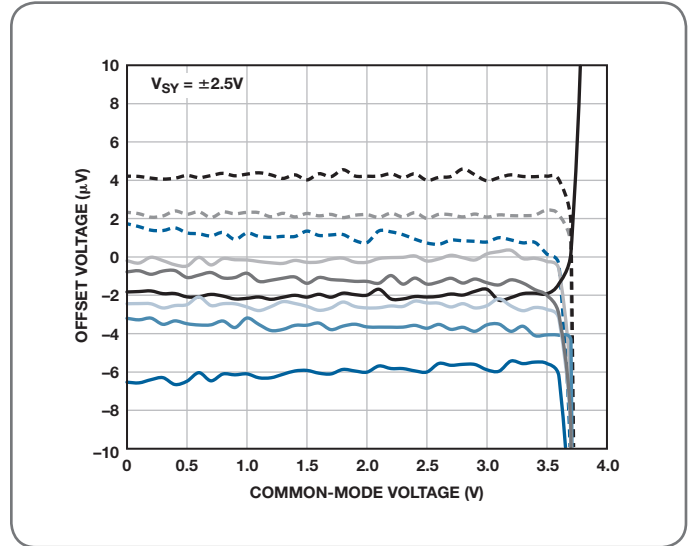

Input offset voltage vs. common-mode voltage.

ADA4077-1/ADA4077-2/ADA4077-4: 4 MHz, $7 \text{ nV}/\sqrt{\text{Hz}}$, Low Offset and Drift, High Precision Amplifiers

The ADA4077-1/ADA4077-2/ADA4077-4 family features extremely low offset voltage and drift and low input bias current, noise, and power consumption. It is specifically suited for applications in process control, chemical and environmental monitoring, motor control, and electronic test and instrumentation due to its high dc precision with noise, speed, and supply current applicable for the designs.

Features

- Very low offset voltage: $25 \mu\text{V}$ max (B-grade)
- Low input offset voltage drift: $0.25 \mu\text{V}/^\circ\text{C}$ max (B-grade)
- Input bias current: $< 1 \text{ nA}$ max
- Very low voltage noise: $7 \text{ nV}/\sqrt{\text{Hz}}$ typical
- CMRR, PSSS, and AVO $> 120 \text{ dB}$ min
- Low supply current: $400 \mu\text{A}$ /amp typical
- Wide bandwidth: 2.0 MHz
- Dual supply operation: $\pm 5 \text{ V}$ to $\pm 15 \text{ V}$

Applications

- Process control front-end amplifiers
- Wireless base station control circuits
- Optical network control circuits
- Instrumentation
- Sensors and controls
- Precision filters

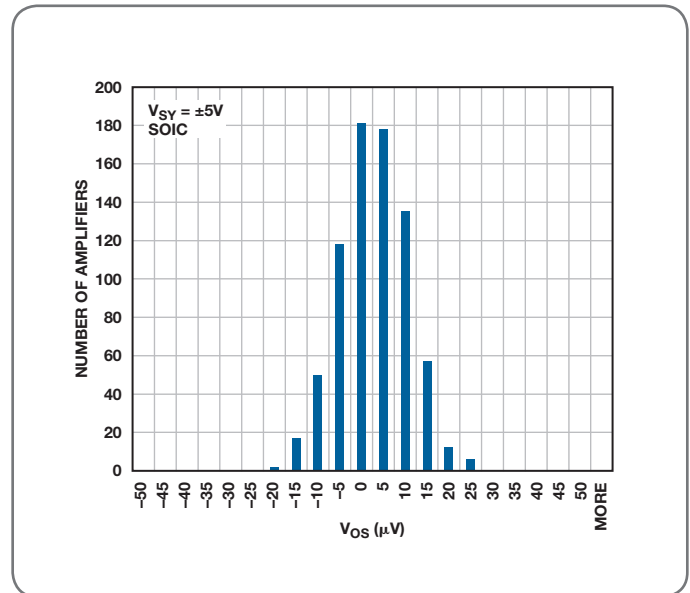

Offset voltage distribution.

Ultralow Offset Voltage ($V_{os} \leq 250 \mu V$ Max) Amplifiers

Process	Part Number	No. of Amps	Supply Voltage (Min/Max)	Rail-to-Rail ¹	BW @ A_{cl} Min (MHz)	Slew Rate (V/ μ s)	V_{os} Max (mV)	TcV_{os} (μ V/ $^{\circ}$ C Typ)	CMRR Min (dB)	PSRR Min (dB)	A_{vo} Min (dB)	Noise (nV/ \sqrt{Hz}) @ 1 kHz	I_s /Amp (mA Max)	I_b Max	Packaging	Price @ 1k (OEM \$US)
CMOS	AD8628	1	2.7/6	RRIO	2.5	1	0.005	0.002	120	115	125	22	0.850	100 pA	SOT-23/SOIC	0.96
	AD8629	2													MSOP/SOIC	1.47
	AD8630	4													SOIC/TSSOP	2.73
CMOS	AD8551	1	2.7/6	RRIO	1.5	0.4	0.005	0.005	120	120	125	42	0.975	50 pA	MSOP/SOIC	1.22
	AD8552	2													SOIC/TSSOP	1.94
	AD8554	4													SOIC/TSSOP	3.43
CMOS	AD8571	1	2.7/6	RRIO	1.5	0.4	0.005	0.005	120	120	125	51	0.850	50 pA	MSOP/SOIC	1.11
	AD8572	2													SOIC/TSSOP	1.78
	AD8574	4													SOIC/TSSOP	3.40
CMOS	AD8638	1	5/16	SS	1.5	2	0.009	0.03	127	127	130	60	1.500	75 pA	SOT-23/SOIC	1.08
	AD8639	2													MSOP/SOIC/LFCSP	1.89
CMOS	ADA4528-1	1	2.2/5.5	RRIO	4	0.45	0.0025	0.002	137	130	127	5.9	1.800	200 pA	MSOP/LFCSP	0.98
	ADA4528-2	2														1.52
CMOS	ADA4638-1	1	9.0/33	RRO	1.5	1.5	0.0045	0.0125	130	120	140	66	1.050	90 pA	LFCSP/ SOIC	1.28
CMOS	AD8538	1	2.7/5.5	RRIO	0.43	0.35	0.013	0.03	115	105	115	50	0.180	25 pA	SOT-23/SOIC	0.50
	AD8539	2													MSOP/SOIC	0.72
CMOS	ADA4051-1	1	1.8/5.5	RRIO	0.125	0.06	0.015	0.02	110	110	115	95	0.017	70 pA	SC70/SOT-23	0.93
	ADA4051-2	2													MSOP/LFCSP	1.47
CMOS	ADA4661-2	2	3/20.5	RRIO	4.5	2.2	0.15	2.1	100	120	120	18	0.725	3 pA	SOIC/ LFCSP	1.13
Bipolar	AD8676B	2	$\pm 5/\pm 18$	RRO	10	2.5	0.05	0.2	111	106	123	2.8	3.400	2 nA	MSOP/SOIC	2.14
Bipolar	AD8675	1	$\pm 5/\pm 18$	RRO	10	2.5	0.075	0.2	114	120	123	2.8	2.900	2 nA	MSOP/SOIC	1.18
Bipolar/JFET	ADA4077-1B		$\pm 4.5/\pm 18$		4	1	0.025	0.1	132	123	125	7	0.500	1 nA	SOT23	2.36
	ADA4077-2B														SOIC	3.81
Bipolar	ADA4077-1A		$\pm 4.5/\pm 18$		4	1	0.05	0.25	132	123	125	7	0.500	1 nA	MSOP	0.77
	ADA4077-2A														MSOP/SOIC	1.38
	ADA4077-4A														SOIC/TSSOP	2.90
Bipolar	AD8671	1	$\pm 5/\pm 18$		10	4	0.075	0.3	100	110	120	2.8	3.500	12 nA	MSOP/SOIC	1.06
	AD8672	2													MSOP/SOIC	1.62
	AD8674	4													SOIC/TSSOP	3.24
JFET	AD8610B	1	$\pm 5/\pm 13$		25	60	0.1	0.5	90	100	100	6	3.500	10 pA	MSOP/SOIC	9.86
	AD8620B	2													SOIC	16.70
Bipolar	AD8676A	2	$\pm 5/\pm 18$	RRO	10	2.5	0.1	0.2	111	106	123	2.8	3.400	2 nA	MSOP/SOIC	1.66
CMOS	ADA4500-2		2.7/6	RRIO	10	5.5	0.12	0.9	95	98	105	14.5	1.750	2 pA	LFCSP/MSOP	0.98
Bipolar	AD8597	1	$\pm 4.5/\pm 18$		10	16.8	0.12	0.8	120	120	110	1.07	5.700	200 nA	SOIC/LFCSP	2.25
	AD8599	2													SOIC	3.24
Bipolar	ADA4004-1	1	$\pm 5/\pm 18$		12	2.7	0.125	0.7	110	110	114	1.8	2.200	90 nA	SOT-23/SOIC	1.14
	ADA4004-2	2													MSOP/SOIC	1.73
	ADA4004-4	4													SOIC/LFCSP	3.41
Bipolar	AD8622	2	$\pm 2.5/\pm 18$	RRO	0.56	0.48	0.125	0.5	125	125	125	11	0.250	200 pA	MSOP/SOIC	2.30
	AD8624	4													LFCSP/TSSOP	3.75
Bipolar	AD8677	1	$\pm 4/\pm 18$		0.6	0.2	0.13	0.5	120	115	120	10	1.300	1 nA	SOT-23/SOIC	0.76
CMOS	AD8661	1	5/16	SS	4	3.5	0.16	4	90	95	106	12	1.550	1 pA	SOIC/LFCSP	1.08
	AD8662	2													MSOP/SOIC	1.37
	AD8664	4													SOIC/TSSOP	2.23
JFET	ADA4627-1B	1	$\pm 4/\pm 18$		19	84	0.2	1	106	106	112	6.1	7.500	5 pA	SOIC/LFCSP	4.78
CMOS	AD8655	1	2.7/5.5	RRIO	28	11	0.25	0.4	85	88	100	2.7 ²	4.500	10 pA	MSOP/SOIC	0.71
	AD8656	2													MSOP/SOIC	1.11
JFET	AD8610A	1	$\pm 5/\pm 13$		25	60	0.25	0.8	90	100	100	6	3.500	10 pA	MSOP/SOIC	3.75
	AD8620A	2													SOIC	7.50
JFET	AD549K	1	$\pm 2.5/\pm 18$		5	3	0.25	5	90	90	109	35	0.700	100 fA	Header	23.48
Bipolar	ADA4091-2	2	$\pm 1.35/\pm 18$	RRIO	1.27	0.46	0.25	2.5	104	108	116	25	0.250	55 nA	SOIC/LFCSP	2.22
	ADA4091-4	4													LFCSP/TSSOP	3.60
Bipolar-JFET	OP285	2	$\pm 4.5/\pm 18$		9	22	0.25	1	80	85	108	6	2.500	350 nA	SOIC/PDIP	2.45

*Prerelease

¹ RRIO: rail-to-rail input/output, RRO: rail-to-rail output, SS: single supply (IVR includes $-V_{SY}$).

Precision Amplifiers ($V_{OS} < 1 \text{ mV}$, Bandwidth $< 50 \text{ MHz}$)

Low Offset Voltage ($V_{OS} \leq 1 \text{ mV}$)

AD8657/AD8659: Precision, Micropower, 18 V CMOS RRIO Operational Amplifiers

The AD8657 dual and AD8659 quad are precision, micropower, rail-to-rail input/output (RRIO) amplifiers optimized for low power and wide operating supply voltage range applications. The AD8657/AD8659 operate from 2.7 V up to 18 V with a typical quiescent supply current of 18 μA and achieves low offset voltage thanks to Analog Devices' patented DigiTrim[®] trimming technique. They also have high immunity to electromagnetic interference. The combination of low supply current, low offset voltage, very low input bias current, wide supply range, and rail-to-rail input and output makes the AD8657 ideal for current monitoring in process and motor control applications.

Features

- Micropower at high voltage (18 V): 18 μA typical
- Low offset voltage: 350 μV maximum
- Single-supply operation: 2.7 V to 18 V
- Dual-supply operation: $\pm 1.35 \text{ V}$ to $\pm 9 \text{ V}$
- Low input bias current: 20 pA maximum
- Gain bandwidth product: 200 kHz at $A_V = 100$
- Unity-gain stable
- Excellent electromagnetic interference immunity

Applications

- Current monitors
- 4 mA to 20 mA loop drivers
- Buffer/level shifting
- Multipole filters
- Remote/wireless sensors
- Low power transimpedance amplifiers

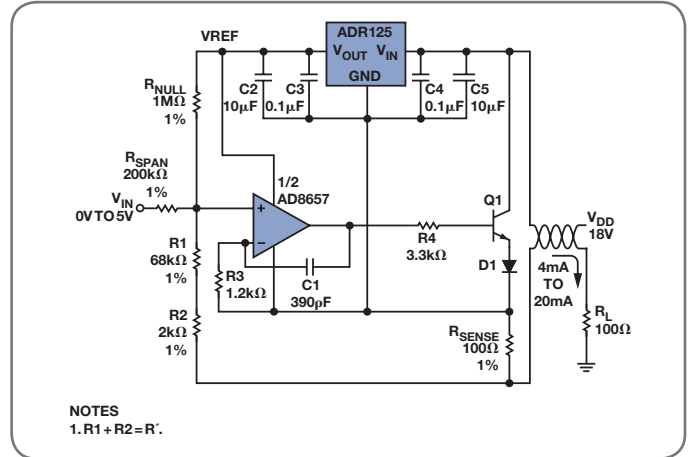

4 mA to 20 mA current loop transmitter.

Low Offset Voltage ($V_{OS} \leq 1 \text{ mV}$) Amplifiers

Process	Part Number	No. of Amps	Supply Voltage (Min/Max)	V_{OS} Max (mV)	TcV_{OS} ($\mu\text{V}/^\circ\text{C}$ Typ)	Rail-to-Rail ¹	BW @ A_{OL} Min (MHz)	Slew Rate ($\text{V}/\mu\text{s}$)	CMRR Min (dB)	PSRR Min (dB)	A_{VO} Min (dB)	Noise ($\text{nV}/\sqrt{\text{Hz}}$) @ 1 kHz	I_S /Amp (mA Max)	I_b Max	Packaging	Price @ 1k (OEM \$US)
CMOS	AD8603	1	1.8/6	0.3	1	RRIO	0.4	0.1	85	80	112	25	0.040	1 pA	SOT-23	0.68
	AD8607	2													MSOP/SOIC	1.02
	AD8609	4													SOIC/TSSOP	1.85
CMOS	AD8605	1	2.7/6	0.3	1	RRIO	10	5	85	80	109	8	1.200	1 pA	WLCSP/SOT-23	0.68
	AD8606	2													WLCSP/MSOP/SOIC	1.19
	AD8608	4													SOIC/TSSOP	1.58
CMOS	AD8663	1	5/16	0.3	1.5	SS	0.54	0.6	87	95	115	23	0.285	0.3 pA typ	SOIC/LFCSP	1.17
	AD8667	2													MSOP/SOIC	1.58
	AD8669	4													SOIC/TSSOP	2.70
CMOS	AD8657	2	2.7/18	0.3	4	RRIO	0.175	0.3	95	105	110	50	0.022	5 pA	MSOP/SOIC	0.95
	AD8659	4													SOIC/LFCSP	1.35
JFET	ADA4627-1A	1	$\pm 4/\pm 18$	0.3	1		19	84	100	103	106	6.1	7.500	5 pA	SOIC/LFCSP	3.47
CMOS	AD8651	1	2.7/5.5	0.35	4	RRIO	50	41	80	76	100	4.5 ²	14.000	10 pA	MSOP/SOIC	1.13
	AD8652	2													MSOP/SOIC	1.99
JFET	ADA4610-1B*	1	$\pm 4.5/\pm 18$	0.4	0.5	RRO	9.3	25	106	106	104	7.3	1.850	80 pA	SOIC	TBD
	ADA4610-2B	2													SOIC	3.47
JFET	AD8510B	1	$\pm 5/\pm 18$	0.4	1		8	20	86	86	101	8	2.500	80 pA	MSOP/SOIC	2.33
	AD8512B	2													MSOP/SOIC	4.76
	AD8601A	1													SOT-23	0.63
CMOS	AD8602A	2	2.7/6	0.5	2	RRIO	8.2	5.2	74	67	89	33	1.200	60 pA	MSOP/SOIC	0.83
	AD8604A	4													SOIC/TSSOP	1.13
	AD8615	1													SOT-23	0.76
CMOS	AD8616	2	2.7/6	0.5	1.5	RRIO	24	12	80	70	105	10	1.300	1 pA	MSOP/SOIC	1.29
	AD8618	4													SOIC/TSSOP	2.29
	AD8627	1													SC70/SOIC	1.60
JFET	AD8626	2	$\pm 5/\pm 13$	0.75	2.5	SS	5	5	76	80	103	16	0.850	1 pA	MSOP/SOIC	2.63
	AD8625	4													SOIC/TSSOP	4.09
	AD8641	1													SC70/SOIC	1.47
JFET	AD8642	2	$\pm 2.5/\pm 13$	0.75	2.5	SS	3.5	3	90	90	106	27.5	0.290	1 pA	MSOP/SOIC	2.35
	AD8643	4													SOIC/LFCSP	3.85
	AD8644	1													SOIC/LFCSP	0.75
Bipolar	ADA4075-2	2	$\pm 4.5/\pm 18$	1	0.3		6.5	12	110	106	114	2.8	2.250	100 nA	SOIC/LFCSP	0.75
CMOS	AD8500	1	$\pm 1.8/\pm 5.5$	1	3	RRIO	0.007	0.004	75	90	98	190	0.001	10 pA	SC70	0.71
	ADA4610-1A*	1													TBD	
JFET	ADA4610-2A	2	$\pm 4.5/\pm 18$	1	1	RRO	9.3	25	106	106	104	7.3	1.850	25 pA	LFCSP/MSOP/SOIC	1.43
	ADA4610-4A*	4													TBD	
	AD8510A	1													MSOP/SOIC	0.95
JFET	AD8512A	2	± 5	1	1.7		8	20	86	86	101	8	2.500	80 pA	MSOP/SOIC	1.49
	AD8513A	4													SOIC/TSSOP	3.71
	AD8682	2													MSOP/SOIC	1.66
JFET	AD8684	4	$\pm 4.5/\pm 18$	1	10		3.5	9	70	92	86	36	0.250	20 pA	SOIC/TSSOP	2.44

*Prerelease

¹ RRIO: rail-to-rail input/output, RRO: rail-to-rail output, SS: single supply (IVR includes $-V_{SY}$).

Precision Amplifiers ($V_{OS} < 1 \text{ mV}$, Bandwidth $< 50 \text{ MHz}$)

Low Power ($I_S/\text{Amp} \leq 1 \text{ mA}$) Amplifiers

AD8546/AD8548: 18 V, Micropower RRIO Operational Amplifiers

The AD8546 and AD8548 are dual and quad micropower, high input impedance amplifiers optimized for low power and wide operating supply voltage range applications. With only 22 μA supply current over a wide operating voltage range of 2.7 V to 18 V, these amplifiers are perfect for a variety of battery-powered, portable applications such as ECGs, pulse monitors, glucose meters, smoke and fire detectors, vibration monitors, and backup battery sensors. Their rail-to-rail input/output feature provides increased dynamic range to drive low frequency data converters, making these amplifiers ideal for dc gain and buffering of sensor front-end or high impedance input sources used in wireless or remote sensors or transmitters.

Features

- Low supply current at high voltage (18 V): 22 μA maximum
- Low Input bias current: 20 pA max
- Single-supply or dual-supply operation
- Slew rate: 80 V/ms
- Large signal voltage gain: 110 dB minimum
- Rail-to-rail input and output
- No phase reversal
- Unity gain stable
- Excellent electromagnetic interference immunity

Applications

- Portable medical equipment
- Remote sensors
- Transimpedance amplifiers
- Current monitors
- 4 mA to 20 mA loop drivers
- Buffer/level shifting

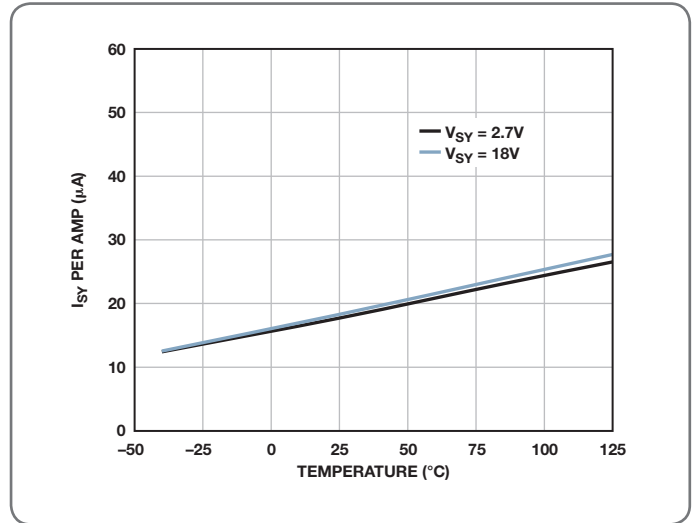

Supply current per amplifier vs. temperature.

Low Power ($I_S/\text{AMP} \leq 1 \text{ mA}$) Amplifiers

Process	Part Number	No. of Amps	Supply Voltage (Min/Max)	I_S/Amp (mA Max)	Rail-to-Rail ¹	BW @ A_{v0} Min (MHz)	Slew Rate (V/ μs)	V_{OS} Max (mV)	$T_C V_{OS}$ ($\mu\text{V}/^\circ\text{C}$ Typ)	CMRR Min (dB)	PSRR Min (dB)	A_{v0} Min (dB)	Noise (nV/ $\sqrt{\text{Hz}}$) @ 1 kHz	I_b Max (pA)	Packaging	Price @ 1k (OEM \$US)
CMOS	AD8546	2	3/18	1.200	RRIO	0.2	0.07	3	3	80	90	88	50	20	MSOP/SOIC	0.78
	AD8548	4														1.05
CMOS	AD8500	1	1.8/5.5	0.001	RRIO	0.007	0.004	1	3	75	90	98	190	10	SC70	0.71
CMOS	AD8502	2	1.8/5.5	0.001	RRIO	0.007	0.004	3	5	67	85	98	190	10	SOT-23	0.70
	AD8504	4													TSSOP	1.00
CMOS	ADA4505-1	1	1.8/5.5	0.010	RRIO	0.050	0.006	3	2	90	100	105	65	2	Micro CSP/SOT-23	0.41
	ADA4505-2	2													Micro CSP/MSOP	0.57
	ADA4505-4	4													Micro CSP/TSSOP	1.01
CMOS	ADA4051-1	1	1.8/5.5	0.017	RRIO	0.125	0.06	0.015	0.02	110	110	115	95	70	SC70/SOT-23	0.93
	ADA4051-2	2													MSOP/LFCSP	1.47
CMOS	AD8505 ²	1	1.8/5.5	0.020	RRIO	0.095	0.013	2.5	2	90	100	105	45	10	Micro CSP/SOT-23	0.47
	AD8506	2													Micro CSP/MSOP	0.57
	AD8508	4													Micro CSP/TSSOP	1.02
CMOS	AD8657	2	2.7/18	0.022	RRIO	0.175	0.3	0.3	4	95	105	110	50	5	MSOP/SOIC	0.95
	AD8659	4													SOIC/LFCSP	1.35
CMOS	AD8603	1	1.8/6	0.040	RRIO	0.4	0.1	0.3	1	85	80	112	25	1	SOT-23	0.68
	AD8607	2													MSOP/SOIC	1.02
	AD8609	4													SOIC/TSSOP	1.85
CMOS	AD8613	1	1.8/5.5	0.040	RRIO	0.4	0.1	2.2	1	68	67	107	25	1	SC70/SOT-23	0.46
	AD8617	2													MSOP/SOIC	0.71
	AD8619	4													SOIC/TSSOP	1.11
CMOS	AD8541	1	2.7/6	0.045	RRIO	1	0.92	6	4	40	65	86	40	60	SC70/SOT-23/SOIC	0.27
	AD8542	2													MSOP/SOIC/TSSOP	0.38
	AD8544	4													SOIC/TSSOP	0.54
CMOS	AD8538	2	2.7/5.5	0.180	RRIO	0.43	0.35	0.013	0.03	115	105	115	50	25	SOT-23/SOIC	0.90
	AD8539	4													MSOP/SOIC	1.31
JFET	ADA4062-2A	2	$\pm 4/\pm 18$	0.220		1.4	3.3	2.5	4	73	74	76	36	50	MSOP/SOIC/LFCSP	0.75
	ADA4062-4A	4													LFCSP/TSSOP	1.21
JFET	ADA4062-2B	2	$\pm 4/\pm 18$	0.220		1.4	3.3	1.5	4	80	80	76	36	50	SOIC	1.25
CMOS	ADA4692-2	2	2.7/6	0.225	SS	3.6	1.3	2.5	1	75	80	95	16	5	SOIC/LFCSP	0.55
	ADA4692-4	4													TSSOP	0.90
CMOS	ADA4691-2SD	2	2.7/6	0.225	SS	3.6	1.3	2.5	1	75	80	95	16	5	WL CSP/LFCSP	0.57
	ADA4691-4SD	4													LFCSP	0.99
JFET	OP282	2	$\pm 4.5/\pm 18$	0.250		4	9	3	10	70	110	86	36	100	MSOP/SOIC	1.42
	OP482	4													SOIC/PDIP	2.16

¹ RRIO: rail-to-rail input/output, RRO: rail-to-rail output, SS: single supply (IVR includes $-V_{SY}$).

Low Power ($I_s/Amp \leq 1mA$) Amplifiers (continued)

Process	Part Number	No. of Amps	Supply Voltage (Min/Max)	I_s/Amp (mA Max)	Rail-to-Rail ¹	BW @ A_{CL} Min (MHz)	Slew Rate (V/ μ s)	V_{OS} Max (mV)	TcV_{OS} (μ V/ $^{\circ}$ C Typ)	CMRR Min (dB)	PSRR Min (dB)	A_{VO} Min (dB)	Noise (nV/ \sqrt{Hz}) @ 1 kHz	I_b Max (pA)	Packaging	Price @ 1k (OEM \$US)
JFET	AD8682 AD8684	2 4	$\pm 4.5/\pm 18$	0.250		3.5	9	1	10	70	92	86	36	20	MSOP/SOIC SOIC/TSSOP	1.66 2.44
Bipolar	AD8622 AD8624	2 4	$\pm 2.5/\pm 18$	0.250	RRO	0.56	0.48	0.125	0.5	125	125	125	11	200	MSOP/SOIC LFCSP/TSSOP	2.30 3.75
Bipolar	ADA4091-2 ADA4091-4	2 4	$\pm 1.35/\pm 18$	0.250	RRIO	1.27	0.46	0.25	2.5	104	108	116	25	55 nA	SOIC/LFCSP LFCSP/TSSOP	2.22 3.60
Bipolar	ADA4092-4	4	$\pm 1.35/\pm 18$	0.250	RRIO	1.4	0.4	1.5	2.5	90	98	116	30	60 nA	TSSOP	2.50
CMOS	AD8663 AD8667 AD8669	1 2 4	5/16	0.285	SS	0.54	0.6	0.3	1.5	87	95	115	23	0.3 pA typ	SOIC/LFCSP MSOP/SOIC SOIC/TSSOP	1.17 1.58 2.70
JFET	AD8641 AD8642 AD8643	1 2 4	$\pm 2.5/\pm 13$	0.290	SS	3.5	3	0.75	2.5	90	90	106	27.5	1	SC70/SOIC MSOP/SOIC SOIC/LFCSP	1.47 2.35 3.85
CMOS	ADA4665-2	2	5/16	0.400	RRIO	1.2	1	6	3	55	70	85	32	1	MSOP/SOIC	0.70
CMOS	AD8515	1	1.8	0.550	RRIO	5	2.7	6	4	60	65	113	22	30	SC70/SOT-23	0.28
JFET	AD549J	1	$\pm 2.5/\pm 18$	0.700		5	3	1	20	80	80	109	35	250 fA	TO-99	18.26
JFET	AD549K	1	$\pm 2.5/\pm 18$	0.700		5	3	0.25	5	90	90	109	35	100 fA	TO-99	23.48
JFET	AD549L	1	$\pm 2.5/\pm 18$	0.700		5	3	0.5	10	90	90	109	35	60 fA	TO-99	27.31
CMOS	AD8591 SD AD8592 SD AD8594 SD	1 2 4	2.7/6	0.700	RRIO	3	5	25	20	38	45	83	45	50	SOT-23 SOIC SOIC/TSSOP	0.29 0.39 0.57
CMOS	AD8531 AD8532 AD8534	1 2 4	2.7/6	0.700	RRIO	3	5	25	20	38	45	83	45	50	SC70/SOT-23 MSOP/SOIC/TSSOP SOIC/TSSOP	0.27 0.43 0.60
CMOS	ADA4661-2	2	3/20.5	0.725	RRIO	4.5	2.2	0.15	2.1	100	120	120	18	3	SOIC/LFCSP	1.13
CMOS	ADA4666-2	2	3/20.5	0.725	RRIO	4.5	2.2	2.2	3	64	120	105	18	3	SOIC/LFCSP	0.85
CBCMOS	OP162 OP262 OP462	1 2 4	2.7/12	0.800	SS	15	13	0.325	1	70	60	97	9.5	500 nA	MSOP/SOIC/TSSOP SOIC/TSSOP SOIC/TSSOP	1.69 2.27 4.11
Bipolar	AD8565 AD8566 AD8567	1 2 4	4.5/16	0.850	RRIO	5	6	10	5	54	70	69	26	600 nA	SC70 MSOP LFCSP/TSSOP	0.56 0.71 0.93
JFET	AD8627 AD8626 AD8625	1 2 4	$\pm 5/\pm 13$	0.850	SS	5	5	0.75	2.5	76	80	103	16	1	SC-70/SOIC MSOP/SOIC SOIC/TSSOP	1.60 2.63 4.09
CMOS	AD8628 AD8629 AD8630	1 2 4	2.7/6	0.850	RRIO	2.5	1	0.005	0.002	120	115	125	22	100	SOT-23/SOIC MSOP/SOIC SOIC/TSSOP	0.96 1.47 2.73
CMOS	AD8571 AD8572 AD8574	1 2 4	2.7/6	0.850	RRIO	1.5	0.4	0.005	0.005	120	120	125	51	50	MSOP/SOIC SOIC/TSSOP SOIC/TSSOP	1.11 1.78 3.40
JFET	AD820A AD822A AD824A	1 2 4	$\pm 2.5/\pm 18$	0.900	SS	1.9	3	2	2	70	70	114	16	25	MSOP/SOIC/PDIP MSOP/SOIC/PDIP SOIC	1.82 2.84 4.87
JFET	AD820B AD822B	1 2	$\pm 2.5/\pm 18$	0.900	SS	1.9	3	1	2	74	70	114	16	10	SOIC/PDIP MSOP/SOIC/PDIP	2.66 4.23
CMOS	AD8551 AD8552 AD8554	1 2 4	2.7/6	0.975	RRIO	1.5	0.4	0.005	0.005	120	120	125	42	50	MSOP/SOIC SOIC/TSSOP SOIC/TSSOP	1.22 1.94 3.43

¹ RRIO: rail-to-rail input/output, RRO: rail-to-rail output, SS: single supply (IVR includes $-V_{SV}$).

² Check data sheet for test conditions and actual product specification—may be different for single/dual/quad amplifiers.

Precision Amplifiers ($V_{OS} < 1 \text{ mV}$, Bandwidth $< 50 \text{ MHz}$)

Low Noise ($V_n \leq 10 \text{ nV}/\sqrt{\text{Hz}}$) Amplifiers

ADA4084-2/ADA4084-4: 30 V, Ultralow Noise Amplifiers at Low Power

The ADA4084-2/ADA4084-4 are high performance low noise, 10 MHz bandwidth amplifiers featuring rail-to-rail inputs and outputs. These amplifiers are guaranteed to operate from 3 V to 30 V (or $\pm 1.5 \text{ V}$ to $\pm 15 \text{ V}$) and are well suited for single-supply applications requiring both ac and precision dc performance. The combination of wide bandwidth, low noise, and precision makes the ADA4084-2/ADA4084-4 family useful in a wide variety of applications, including filters and instrumentation. The ADA4084-2/ADA4084-4 are the latest members of a growing series of high voltage, low noise op amps offered by Analog Devices.

Features

- Ultralow noise: $3.9 \text{ nV}/\sqrt{\text{Hz}}$ typical at 1 kHz
- Low supply current: 625 μA typical
- Offset voltage: 100 μV maximum
- Bandwidth: 15.9 MHz typical at $A_V = 100$
- Slew rate: 4.6 μs typical
- Rail-to-rail Input/Output

Applications

- Battery-powered instrumentation
- Power supply control and protection
- Telecommunications
- DAC output amplifiers
- ADC input buffers

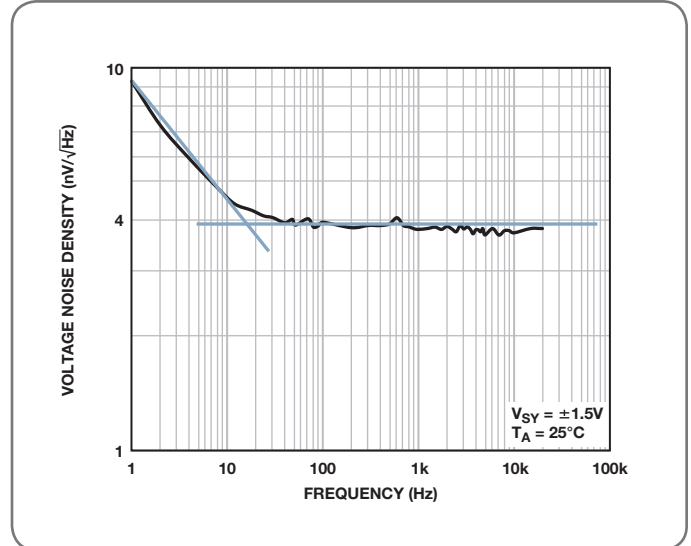

Voltage noise density.

ADA4004-1/ADA4004-2/ADA4004-4: Ultraprecision, $1.8 \text{ nV}/\sqrt{\text{Hz}}$, 36 V Amplifiers

The ADA4004-1/ADA4004-2/ADA4004-4 are designed with the high performance *rPolar*® process, enabling improvements such as reduced noise and power consumption, increased speed and stability, and smaller footprint size. Novel design techniques enable the ADA4004-1/ADA4004-2/ADA4004-4 to achieve $1.8 \text{ nV}/\sqrt{\text{Hz}}$ voltage noise density and a low 6 Hz 1/f noise corner frequency while consuming just 1.7 mA per amplifier. The small package saves board space, reduces cost, and improves layout flexibility.

Features

- Very low voltage noise: $1.8 \text{ nV}/\sqrt{\text{Hz}}$
- Low input bias current: 90 nA maximum
- Offset voltage: 125 μV maximum
- High gain: 120 dB
- Wide bandwidth: 12 MHz
- $\pm 5 \text{ V}$ to $\pm 15 \text{ V}$ operation

Applications

- Precision instrumentation
- Filter blocks
- Microphone preamplifiers
- Industrial control
- Thermocouples and RTDs

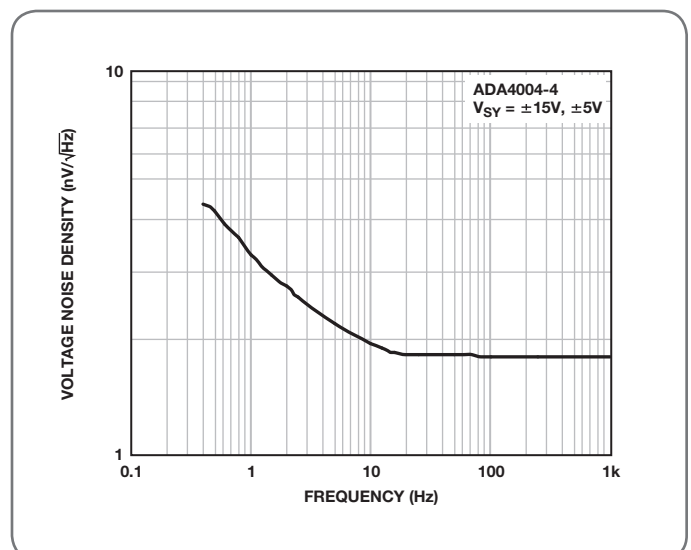

Voltage noise density vs. frequency.

Low Noise ($V_n \leq 10\text{nV}/\sqrt{\text{Hz}}$) Amplifiers

Process	Part Number	No. of Amps	Supply Voltage (Min/Max)	Noise ($\text{nV}/\sqrt{\text{Hz}}$) @ 1 kHz	Rail-to-Rail ¹	BW @ A_{cl} Min (MHz)	Slew Rate ($\text{V}/\mu\text{s}$)	V_{os} Max (mV)	$\text{TC}_{V_{os}}$ ($\mu\text{V}/^\circ\text{C}$ Typ)	CMRR Min (dB)	PSRR Min (dB)	A_{vo} Min (dB)	Noise ($\mu\text{A}/\sqrt{\text{Hz}}$) @ 1 kHz	I_s /Amp (mA Max)	I_b Max (pA)	I_{sc} (mA)	Packaging	Price @ 1k (OEM \$US)
Bipolar	AD8597 AD8599	1 2	$\pm 4.5/\pm 18$	1.07		10	16.8	0.12	0.8	120	120	110	1.9	5.700	200 nA	52	SOIC/LFCSP SOIC	2.25 3.24
Bipolar	ADA4004-1 ADA4004-2 ADA4004-4	1 2 4	$\pm 5/\pm 18$	1.8		12	2.7	0.125	0.7	110	110	114	1.2	2.200	90 nA	25	SOT-23/SOIC MSOP/SOIC SOIC/LFCSP	1.75 2.65 4.25
Bipolar	ADA4075-2	2	$\pm 4.5/\pm 18$	2.8		6.5	12	1	0.3	110	106	114	1.2	2.250	100 nA	40	SOIC/LFCSP	0.75
Bipolar	AD8675	1	$\pm 5/\pm 18$	2.8	RRO	10	2.5	0.075	0.2	114	120	123	0.3	2.900	2 nA	40	MSOP/SOIC	1.18
Bipolar	AD8676A	2	$\pm 5/\pm 18$	2.8	RRO	10	2.5	0.1	0.2	111	106	123	0.3	3.400	2 nA	40	MSOP/SOIC	1.66
Bipolar	AD8676B	2	$\pm 5/\pm 18$	2.8	RRO	10	2.5	0.05	0.2	111	106	123	0.3	3.400	2 nA	40	MSOP/SOIC	2.14
Bipolar	AD8671 AD8672 AD8674	1 2 4	$\pm 5/\pm 18$	2.8		10	4	0.075	0.3	100	110	120	0.3	3.500	12 nA	30	MSOP/SOIC MSOP/SOIC SOIC/TSSOP	1.06 1.62 3.24
Bipolar	ADA4084-1* ADA4084-2 ADA4084-4	1 2 4	$\pm 2/36$	3.9	RRIO	9.9	4.6	0.1	0.5	106	110	110	0.55	0.750	300 nA	30 ²	LFCSP/MSOP TSSOP/LFCSP	TBD 2.85 4.45
JFET	AD8610A AD8620A	1 2	$\pm 5/\pm 13$	6		25	60	0.25	0.8	90	100	100	0.005	3.500	10	65	MSOP/SOIC SOIC	3.75 7.50
JFET	AD8610B AD8620B	1 2	$\pm 5/\pm 13$	6		25	60	0.1	0.5	90	100	100	0.005	3.500	10	65	MSOP/SOIC SOIC	9.86 16.70
CMOS	ADA4528-1 ADA4528-2	1 2	2.2/5.5	5.9	RRIO	4	0.4	0.0025	0.002	137	130	127	0.5	1.800	200	25	MSOP/LFCSP	0.98 1.52
JFET	ADA4627-1A	1	$\pm 4/\pm 18$	6.1		19	84	0.3	1	100	103	106	2.5f	7.500	5	55	SOIC/LFCSP	3.47
JFET	ADA4627-1B	1	$\pm 4/\pm 18$	6.1		19	84	0.2	1	106	106	112	1.6f	7.500	5	55	SOIC/LFCSP	4.78
JFET	ADA4637-1A	1	$\pm 4/\pm 18$	6.1		79	170	0.3	1	100	103	106	2.5f	7.500	5	55	LFCSP/MSOP	3.47
JFET	ADA4637-1B	1	$\pm 4/\pm 18$	6.1		79	170	0.2	1	106	106	112	1.6f	7.500	5	55	LFCSP/MSOP	4.78
HVBP3	ADA4077-1A ADA4077-2A ADA4077-4A	1 2 4	$\pm 4.5/\pm 18$	7		4	1	0.05	0.25	132	123	125	3	0.500	1 nA	22	MSOP/SOIC MSOP/SOIC SOIC/TSSOP	0.77 1.38 2.90
HVBP3	ADA4077-1B ADA4077-2B	1 2	$\pm 4.5/\pm 18$	7		4	1	0.025	0.1	132	123	125	3	0.500	1 nA	22	SOT23 SOIC	2.36 3.81
JFET	ADA4610-1A* ADA4610-2A ADA4610-4A*	1 2 4	$\pm 4.5/\pm 18$	7.3	RRO	9.3	25	1	1	106	106	104		1.850	25	79	MSOP, SOIC SOIC, LFCSP SOIC, TSSOP	TBD 1.43 TBD
JFET	ADA4610-1B* ADA4610-2B	1 2	$\pm 4.5/\pm 18$	7.3	RRO	9.6	25	0.4	0.5	106	106	104		1.850	25	79	SOIC SOIC	TBD 3.47
JFET	ADA4001-2	2	$\pm 4.5/\pm 18$	7.7	RRO	10.2	25	1.5	5	96	96	104	0.003	3.000	30	50	SOIC	1.09
CMOS	AD8605 AD8606 AD8608	1 2 4	2.7/6	8	RRIO	10	5	0.3	1	85	80	109	0.01	1.200	1	80	Micro CSP/SOT-23 Micro CSP/MSOP/SOIC SOIC/TSSOP	0.68 1.19 1.58
JFET	AD8510A AD8512A AD8513A	1 2 4	$\pm 5/\pm 18$	8		8	20	1	1.7	86	86	101		2.500	80	70	MSOP/SOIC MSOP/SOIC SOIC/TSSOP	0.95 1.49 3.71
JFET	AD8510B AD8512B	1 2	$\pm 5/\pm 18$	8		8	20	0.4	1	86	86	101		2.500	80	70	MSOP/SOIC MSOP/SOIC	2.33 4.76
CMOS	AD8691 AD8692 AD8694	1 2 4	2.7/6	8	SS	10	5	2	1.3	70	80	108	0.05	1.050	1	80	SC70/SOT-23 MSOP/SOIC SOIC/TSSOP	0.44 0.60 0.80
CMOS	AD8646 AD8648	2 4	2.7/6	8	RRIO	24	11	2.5	1.8	67	63	104		1.500	1	120	MSOP/SOIC SOIC/TSSOP	0.61 0.88
CMOS	AD8647	2	2.7/6	8	RRIO	24	11	2.5	1.8	67	63	104		1.500	1	120	MSOP	0.71
Bipolar	OP162 OP262 OP462	1 2 4	2.7/12	9.5	SS	15	13	0.325	1	70	60	97	0.4	0.800	500 nA	30 ²	MSOP/SOIC/TSSOP SOIC/TSSOP SOIC/TSSOP	1.69 2.27 4.11
Bipolar	AD8519 AD8529	1 2	2.7/12	10	SS	8	2.9	1.1	2	70 ²	60	94	0.4	1.200	300 nA	70	SC70/SOT-23/SOIC MSOP/SOIC	0.94 1.24
CMOS	AD8615 AD8616 AD8618	1 2 4	2.7/6	10	RRIO	24	12	0.5	1.5	80	70	105	0.05	1.300	1	150	SOT-23 MSOP/SOIC SOIC/TSSOP	0.76 1.29 2.29
Bipolar	AD8677	1	$\pm 4/\pm 18$	10		0.6	0.2	0.13	0.5	120	115	120	0.074	1.300	1 nA	30	SOT-23/SOIC	0.76
γ CMOS	AD8665 AD8666 AD8668	1 2 4	5/16	10	SS	4	3.5	2.5	3	90	98	130	0.1	1.550	1	140	SOT-23/SOIC MSOP/SOIC SOIC/TSSOP	0.83 0.93 1.75

*Prerelease

¹ RRIO: rail-to-rail input/output, RRO: rail-to-rail output, SS: single supply (IVR includes $-V_{sv}$).

² Check data sheet for test conditions and actual product specification-may be different for single/dual/quad amplifiers.

Precision Amplifiers ($V_{OS} < 1 \text{ mV}$, Bandwidth $< 50 \text{ MHz}$)

Low Input Bias Current ($I_B \leq 50 \text{ pA}$) Amplifiers

ADA4610-2: Low Noise, Low Bias Current, RRO JFET Amplifier

The ADA4610-2 is a dual-channel, precision JFET amplifier that features low input voltage and current noise, offset voltage, input bias current, and rail-to-rail output. Unlike many older JFET amplifiers, the ADA4610-2 does not suffer from output phase reversal when input voltages exceed the maximum common-mode voltage range.

Features

- Low offset voltage: 400 μV maximum (B-grade)
- Offset drift: 4 $\mu\text{V}/^\circ\text{C}$ maximum (B-grade)
- Very low input bias current: 5 pA maximum
- $\pm 4.5 \text{ V}$ to $\pm 15 \text{ V}$ dual supply
- Low voltage noise: 7.3 $\text{nV}/\sqrt{\text{Hz}}$ typical at 1 kHz
- Low distortion: 0.00006%
- Rail-to-rail output

Applications

- Instrumentation
- Medical Instruments
- Multiple filters
- Precision current measurement
- Photodiode amplifiers
- Sensors
- Audio

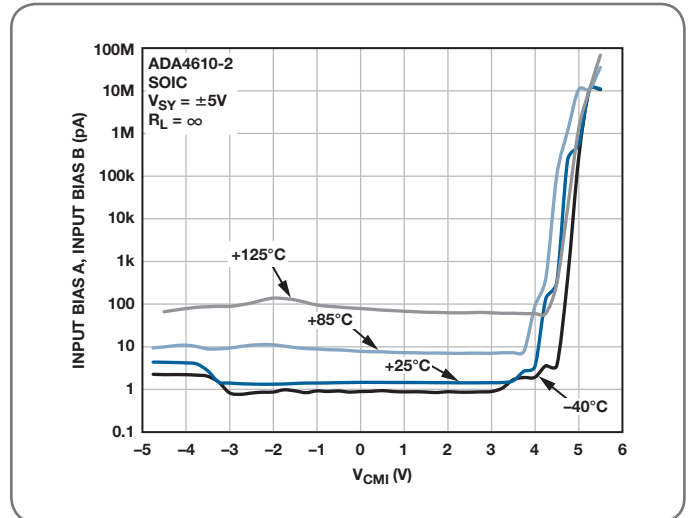

Input bias current vs. common-mode voltage and temperature.

Low Input Bias Current ($I_B \leq 50 \text{ pA}$) Amplifiers

Process	Part Number	No. of Amps	Supply Voltage (Min/Max)	Rail-to-Rail ¹	BW @ A_{CL} Min (MHz)	Slew Rate ($\text{V}/\mu\text{s}$)	V_{OS} Max (mV)	$\text{TC}_{V_{OS}}$ ($\mu\text{V}/^\circ\text{C}$ Typ)	CMRR Min (dB)	PSRR Min (dB)	A_{VO} Min (dB)	Noise ($\text{nV}/\sqrt{\text{Hz}}$) @ 1 kHz	Noise ($\text{pA}/\sqrt{\text{Hz}}$) @ 1 kHz	I_S /Amp (mA Max)	I_B Max (pA)	Packaging	Price @ 1k (OEM \$US)
JFET	AD549L	1	$\pm 2.5/\pm 18$		5	3	0.5	10	90	90	109	35	0.22	0.700	60 fA	TO-99	27.31
JFET	AD549K	1	$\pm 2.5/\pm 18$		5	3	0.25	5	90	90	109	35	0.22	0.700	100 fA	TO-99	23.48
JFET	AD549J	1	$\pm 2.5/\pm 18$		5	3	1	20	80	80	109	35	0.22	0.700	250 fA	TO-99	18.26
BiJET	OP285	2	$\pm 4.5/\pm 18$		9	22	0.25	1	80	85	108	6	0.9	2.500	350 nA	SOIC/PDIP	2.40
CMOS	AD8663	1													0.3 pA typ	SOIC/LFCSP	1.17
	AD8667	2	5/16	SS	0.54	0.6	0.3	1.5	87	95	115	23	0.05	0.285		MSOP/SOIC	1.58
	AD8669	4														SOIC/TSSOP	2.70
CMOS	AD8603	1													1	SOT-23	0.68
	AD8607	2	1.8/6	RRIO	0.4	0.1	0.3	1	85	80	112	25	0.05	0.040		MSOP/SOIC	1.02
	AD8609	4														SOIC/TSSOP	1.85
CMOS	AD8605	1													1	WLCSP/SOT-23	0.68
	AD8606	2	2.7/6	RRIO	10	5	0.3	1	85	80	109	8	0.01	1.200		WLCSP/MSOP/SOIC	1.19
	AD8608	4														SOIC/TSSOP	1.58
CMOS	AD8615	1													1	SOT-23	0.76
	AD8616	2	2.7/6	RRIO	24	12	0.5	1.5	80	70	105	10	0.05	1.300		MSOP/SOIC	1.29
	AD8618	4														SOIC/TSSOP	2.29
CMOS	AD8661	1													1	SOIC/LFCSP	1.08
	AD8662	2	5/16	SS	4	3.5	0.16	4	90	95	106	12	0.1	1.550		MSOP/SOIC	1.37
	AD8664	4														SOIC/TSSOP	2.23
JFET	AD8627	1													1	SC70/SOIC	1.60
	AD8626	2	$\pm 5/\pm 13$	SS	5	5	0.75	2.5	76	80	103	16	0.5	0.850		MSOP/SOIC	2.63
	AD8625	4														SOIC/TSSOP	4.09
JFET	AD8641	1													1	SC70/SOIC	1.47
	AD8642	2	$\pm 2.5/\pm 13$	SS	3.5	3	0.75	2.5	90	90	106	27.5	0.0005	0.290		MSOP/SOIC	2.35
	AD8643	4														SOIC/LFCSP	3.85
CMOS	AD8613	1													1	SC70/SOT-23	0.46
	AD8617	2	1.8/5.5	RRIO	0.4	0.1	2.2	1	68	67	107	25	0.05	0.040		MSOP/SOIC	0.71
	AD8619	4														SOIC/TSSOP	1.11
CMOS	AD8691	1													1	SC70/SOT-23	0.44
	AD8692	2	2.7/6	SS	10	5	2	1.3	70	80	108	8	0.05	1.050		MSOP/SOIC	0.60
	AD8694	4														SOIC/TSSOP	0.80

¹ RRIO: rail-to-rail input/output, RRO: rail-to-rail output, SS: single supply (IVR includes $-V_{SY}$).

Low Input Bias Current ($I_b \leq 50$ pA) Amplifiers (continued)

Process	Part Number	No. of Amps	Supply Voltage (Min/Max)	Rail-to-Rail ¹	BW @ A _c Min (MHz)	Slew Rate (V/μs)	V _{os} Max (mV)	TcV _{os} (μV/°C Typ)	CMRR Min (dB)	PSRR Min (dB)	A _{vo} Min (dB)	Noise (mV/√Hz) @ 1 kHz	Noise (pA/√Hz) @ 1 kHz	I _b /Amp (mA Max)	I _b Max (pA)	Packaging	Price @ 1k (OEM \$US)
CMOS	AD8646	2	2.7/6	RRIO	24	11	2.5	1.8	67	63	104	8		1.500	1	MSOP/SOIC	0.61
	AD8648	4															SOIC/TSSOP
CMOS	AD8647	2	2.7/6	RRIO	24	11	2.5	1.8	67	63	104	8		1.500	1	MSOP	0.71
	AD8665	1															SOT-23/SOIC
CMOS	AD8666	2	5/16	SS	4	3.5	2.5	3	90	98	130	10	0.1	1.550	1	MSOP/SOIC	0.93
	AD8668	4															SOIC/TSSOP
CMOS	ADA4665-2	2	5/16	RRIO	1.2	1	6	3	55	70	85	32		0.400	1	MSOP/SOIC	0.70
CMOS	ADA4500-2	2	2.7/6	RRIO	10	5.5	0.12	0.9	95	98	105	14.5	0.0005	1.750	2	MSOP, LFCSP	0.98
	ADA4505-1	1															1.8/5.5
ADA4505-2	2	Micro CSP/MSOP	0.57														
ADA4505-4	4	Micro CSP/TSSOP	1.01														
	ADA4661-2	2	3/20.5	RRIO	4.500	2.2	0.15	2.1	100	120	120	18	TBD	0.725	3	SOIC/LFCSP	1.13
	ADA4666-2	2	3/20.5	RRIO	4.500	2.2	2.2	3	64	120	105	18	TBD	0.725	3	SOIC/LFCSP	0.85
CMOS	AD8657	2	2.7/18	RRIO	0.175	0.3	0.3	4	95	105	110	50		0.022	5	MSOP/SOIC	0.95
	AD8659	4															SOIC/LFCSP
JFET	ADA4627-1A	1	±4/±18		19	84	0.3	1	100	103	106	6.1	0.0025	7.500	5	SOIC/LFCSP	3.47
JFET	ADA4627-1B	1	±4/±18		19	84	0.2	1	106	106	112	6.1	0.0016	7.500	5	SOIC/LFCSP	4.78
JFET	ADA4637-1A	1	±4/±18		79	170	0.3	1	100	103	106	6.1	2.5f	7.500	5	SOIC/LFCSP	3.47
JFET	ADA4637-1B	1	±4/±18		79	170	0.2	1	106	106	112	6.1	1.6f	7.500	5	SOIC/LFCSP	4.78
CMOS	ADA4692-2	2	2.7/6	SS	3.6	1.3	2.5	1	75	80	95	16	0.05	0.225	5	SOIC/LFCSP	0.55
	ADA4692-4	4															TSSOP
CMOS	ADA4691-2	2	2.7/6	SS	3.6	1.3	2.5	1	75	80	95	16	0.05	0.225	5	WLCSOP/LFCSP	0.57
	ADA4691-4	4															LFCSP
CMOS	AD8500	1	1.8/5.5	RRIO	0.007	0.004	1	3	75	90	98	190	0.1	0.001	10	SC70	0.71
CMOS	AD8655	1	2.7/5.5	RRIO	28	11	0.25	0.4	85	88	100	2.7 ²		4.500	10	MSOP/SOIC	0.71
	AD8656	2															MSOP/SOIC
CMOS	AD8651	1	2.7/5.5	RRIO	50	41	0.35	4	80	76	100	4.5 ²	0.025	14.000	10	MSOP/SOIC	1.13
	AD8652	2															MSOP/SOIC
JFET	AD8610A	1	±5/±13		25	60	0.25	0.8	90	100	100	6	0.005	3.500	10	MSOP/SOIC	3.75
	AD8620A	2															SOIC
JFET	AD8610B	1	±5/±13		25	60	0.1	0.5	90	100	100	6	0.005	3.500	10	MSOP/SOIC	9.86
	AD8620B	2															SOIC
JFET	AD820B	1	±2.5/±18	SS	1.9	3	1	2	74	70	114	16	0.008	0.900	10	SOIC/PDIP	2.66
	AD822B	2															MSOP/SOIC/PDIP
CMOS	AD8505	1	1.8/5.5	RRIO	0.095	0.013	2.5	2	90	100	105	45	0.015	0.020	10	Micro CSP/SOT-23	0.47
	AD8506	2															Micro CSP/MSOP
	AD8508	4	Micro CSP/TSSOP	1.02													
CMOS	ADA4500-2	2	2.7/6	RRIO	10	5.5	0.12	0.9	95	98	105	14.5	0.0005	1.750	2	MSOP/LFCSP	0.98
CMOS	AD8502	2	1.8/5.5	RRIO	0.007	0.004	3	5	67	85	98	190	0.1	0.001	10	SOT-23	0.70
	AD8504	4															TSSOP
JFET	AD8682	2	±4.5/±18		3.5	9	1	10	70	92	86	36	0.01	0.250	20	MSOP/SOIC	1.66
	AD8684	4															SOIC/TSSOP
JFET	ADA4610-1A*	1	±4.5/±18	RRO	9.3	25	1	1	106	106	104	7.3		1.850	25	MSOP/SOIC	TBD
	ADA4610-2A	2															MSOP/SOIC/LFCSP
	ADA4610-4A*	4	SOIC/TSSOP	TBD													
HVBP3	ADA4610-1B*	1	±4.5	RRO	9.3	25	0.4	0.5	106	106	104	7.3		1.850	25	SOIC	TBD
	ADA4610-2B	2															SOIC
JFET	AD820A	1	±2.5/±18	SS	1.9	3	2	2	70	70	114	16	0.008	0.900	25	MSOP/SOIC/PDIP	1.82
	AD822A	2															MSOP/SOIC/PDIP
	AD824A	4	SOIC	4.87													
CMOS	AD8538	1	2.7/5.5	RRIO	0.43	0.35	0.013	0.03	115	105	115	50		0.180	25	SOT-23/SOIC	0.90
	AD8539	2															MSOP/SOIC
CMOS	AD8515	1	1.8/6	RRIO	5	2.7	6	4	60	65	113	22	0.05	0.550	30	SC70/SOT-23	0.28
JFET	ADA4001-2	2	±4.5/±18	RRO	10.2	25	1.5	5	96	96	104	7.7	0.003	3.000	30	SOIC	1.09
JFET	ADA4000-1	1	±4/±18		5	20	1.7	2	80	82	100	16	0.01	1.650	40	SOT-23/SOIC	0.73
	ADA4000-2	2															MSOP/SOIC
	ADA4000-4	4	SOIC/TSSOP	2.22													
JFET	ADA4062-2A	2	±4/±18		1.4	3.3	2.5	4	73	74	76	36	0.005	0.220	50	MSOP/SOIC/LFCSP	0.75
	ADA4062-4A	4															LFCSP/TSSOP
JFET	ADA4062-2B	2	±4/±18		1.4	3.3	1.5	4	80	80	76	36	0.005	0.220	50	SOIC	1.25
CMOS	AD8551	1	2.7/6	RRIO	1.5	0.4	0.005	0.005	120	120	125	42		0.975	50	MSOP/SOIC	1.22
	AD8552	2															SOIC/TSSOP
	AD8554	4	SOIC/TSSOP	3.43													
CMOS	AD8571	1	2.7/6	RRIO	1.5	0.4	0.005	0.005	120	120	125	51		0.850	50	MSOP/SOIC	1.11
	AD8572	2															SOIC/TSSOP
	AD8574	4	SOIC/TSSOP	3.40													
CMOS	AD8591	1	2.7/6	RRIO	3	5	25	20	38	45	83	45	0.05	0.700	50	SOT-23	0.29
	AD8592	2															SOIC
	AD8594	4	SOIC/TSSOP	0.57													

*Prerelease

¹ RRIO: rail-to-rail input/output, RRO: rail-to-rail output, SS: single supply (I_{VR} includes -V_{SS}).

² Check data sheet for test conditions and actual product specification—may be different for single/dual/quad amplifiers for part numbers with * mark.

Precision Amplifiers ($V_{OS} < 1 \text{ mV}$, Bandwidth $< 50 \text{ MHz}$)

Single-Supply Amplifiers and Rail-to-Rail Output Amplifiers

ADA4001-2: Dual, Low Noise, Rail-to-Rail Output Amplifier

The ADA4001-2 is a dual JFET amplifier that features low input bias current, low input voltage noise, low input current noise, and rail-to-rail output. The combination of dc precision, low noise, and fast settling time results in superior accuracy in medical instruments, electronic measurement, and automated test equipment. Low noise and low distortion, high output current, and excellent speed make the ADA4001-2 a great choice for audio applications.

Features

- Low $T_C V_{OS}$: $\pm 5 \mu\text{V}/^\circ\text{C}$ typical
- Low distortion: 0.00006% THD + N
- Low noise: $7.7 \text{ nV}/\sqrt{\text{Hz}}$ typical
- Unity-gain crossover: 10.2 MHz
- Rail-to-rail output
- Unity-gain stable

Applications

- Instrumentation
- Medical instruments
- Multipole filters
- Precision current measurement
- Photodiode amplifiers
- Sensors
- Audio

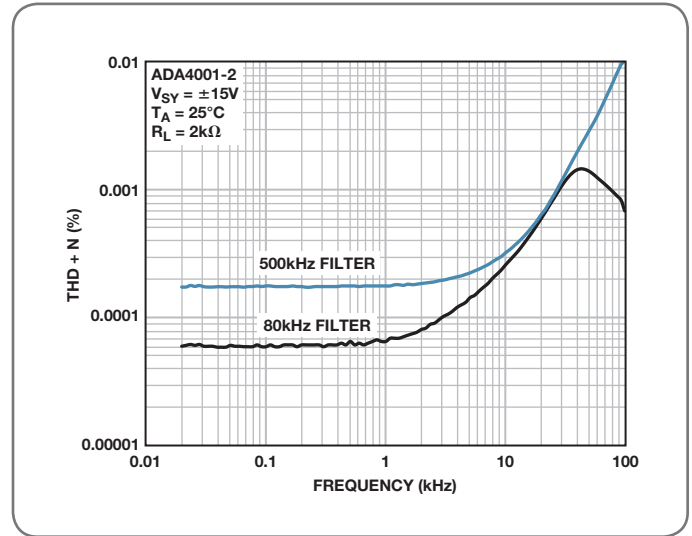

THD + N vs. Frequency.

Single-Supply and Rail-to-Rail Output Amplifiers

Process	Part Number	No. of Amps	Supply Voltage (Min/Max)	Rail-to-Rail ¹	BW @ A _{CL} Min (MHz)	Slew Rate (V/ μs)	V_{OS} Max (mV)	$T_C V_{OS}$ ($\mu\text{V}/^\circ\text{C}$ Typ)	CMRR Min (dB)	PSRR Min (dB)	A_{10} Min (dB)	Noise (nV/ $\sqrt{\text{Hz}}$) @ 1 kHz	Noise (pA/ $\sqrt{\text{Hz}}$) @ 1 kHz	I_S /Amp (mA Max)	I_B Max (pA)	I_{SC} (mA)	Packaging	Price @ 1k (OEM \$US)
Bipolar	OP162	1															MSOP/SOIC/TSSOP	1.69
	OP262	2	2.7/12	SS	15	13	0.325	1	70	60	97	9.5	0.4	0.800		80	SOIC/TSSOP	2.27
	OP462	4															SOIC/TSSOP	4.11
Bipolar	OP281	2	2.7/12	SS	0.105	0.028	1.5	10	65	76	74	85	1	0.005	10 nA	1.1	SOIC/TSSOP	2.79
	OP481	4															SOIC/TSSOP	3.65
Bipolar	AD8519	1	2.7/12	SS	8	2.9	1.1	2	70 ²	60	94	10	0.4	1.200	300 nA	70	SC70/SOT-23/SOIC	0.94
	AD8529	2															MSOP/SOIC	1.24
Bipolar	AD8675	1	$\pm 5/\pm 8$	RRO	10	2.5	0.075	0.2	114	120	123	2.8	0.3 ²	2.900	2 nA	35	MSOP/SOIC	1.18
Bipolar	AD8676A	2	$\pm 5/\pm 8$	RRO	10	2.5	0.1	0.2	111	106	123	2.8	0.3 ²	3.400	2 nA	40	MSOP/SOIC	1.66
Bipolar	AD8676B	2	$\pm 5/\pm 8$	RRO	10	2.5	0.05	0.2	111	106	123	2.8	0.3 ²	3.400	2 nA	40	MSOP/SOIC	2.14
Bipolar	AD8622	2	$\pm 2.5/\pm 18$	RRO	0.56	0.48	0.125	0.5	125	125	125	11	0.15	0.250	200	30	MSOP/SOIC	2.30
	AD8624	4															LFCSP/TSSOP	3.75
JFET	ADA4001-2	2	$\pm 4.5/\pm 18$	RRIO	10.2	25	1.5	5	96	96	104	7.7	0.003	3.000	30	50	SOIC	1.09
Bipolar	ADA4091-2	2	$\pm 1.35/\pm 18$	RRIO	1.27	0.46	0.25	2.5	104	108	116	25		0.250	55 nA	31	SOIC/LFCSP	2.22
	ADA4091-4	4															LFCSP/TSSOP	3.60
Bipolar	OP196	1															SOIC	1.51
	OP296	2	3/15	RRIO	0.45	0.3	0.3	1.5	65 ²	110	109	26	0.19	0.060	50 nA		SOIC/TSSOP/PDIP	1.89
	OP496	4															SOIC/TSSOP/PDIP	2.71
Bipolar	OP191	1															SOIC	1.72
	OP291	2	2.7/12	RRIO	1.5	0.5	0.5	1.1	75	80	88	42	0.8	0.420	65 nA	13.5	SOIC	2.22
	OP491	4															SOIC/TSSOP/PDIP	3.89
Bipolar	AD8565	1															SC70	0.56
	AD8566	2	4.5/16	RRIO	5	6	10	5	54	70	69	26	0.8 ²	0.850	600 nA	35 ²	MSOP	0.71
	AD8567	4															LFCSP/TSSOP	0.93
Bipolar	ADA4092-4	3	$\pm 1.35/\pm 18$	RRIO	1.4	0.4	1.5	2.5	90	98	116	30		0.250	60 nA	20	TSSOP	2.50
CMOS	AD8661	1															SOIC/LFCSP	1.08
	AD8662	2	5/16	SS	4	3.5	0.16	4	90	95	106	12	0.1	1.550	1	140	MSOP/SOIC	1.37
	AD8664	4															SOIC/TSSOP	2.23
CMOS	AD8663	1															SOIC/LFCSP	1.17
	AD8667	2	5/16	SS	0.54	0.6	0.3	1.5	87	95	115	23	0.05	0.285	0.3	50	MSOP/SOIC	1.58
	AD8669	4															SOIC/TSSOP	2.70
CMOS	AD8638	1															SOT-23/SOIC	1.27
	AD8639	2	5/16	SS	1.5	2	0.009	0.03	127	127	130	60		1.500	75	37	MSOP/SOIC/LFCSP	1.89
CMOS	ADA4638-1	1	9/33	SS	1.5	1.5	0.0045	0.013	130	120	140	66	0.1	1.050	90	38	SOIC/LFCSP	1.28

¹ RRIO: rail-to-rail input/output, RRO: rail-to-rail output, S: single supply.

² Check data sheet for test conditions and actual product specification—may be different for single/dual/quad amplifiers.

Single-Supply and Rail-to-Rail Output Amplifiers (continued)

Process	Part Number	No. of Amps	Supply Voltage (Min/Max)	Rail-to-Rail ¹	BW @ A _{CL} Min (MHz)	Slew Rate (V/μs)	V _{os} Max (mV)	TcV _{os} (μV/°C Typ)	CMRR Min (dB)	PSRR Min (dB)	A _{v0} Min (dB)	Noise (nV/√Hz) @ 1 kHz	Noise (pA/√Hz) @ 1 kHz	I _s /Amp (mA Max)	I _b Max (pA)	ISC (mA)	Packaging	Price @ 1k (OEM \$US)
CMOS	AD8691	1	2.7/6	SS	10	5	2	1.3	70	80	108	8	0.05	1.050	1	80	SC70/SOT-23	0.44
	AD8692	2															MSOP/SOIC	0.60
	AD8694	4															SOIC/TSSOP	0.80
CMOS	ADA4692-2	2	2.7/6	SS	3.6	1.3	2.5	1	75	80	95	16	0.05	0.225	5	55	SOIC/LFCSP	0.55
	ADA4692-4	4															TSSOP	0.85
CMOS	ADA4691-2	2	2.7/6	SS	3.6	1.3	2.5	1	75	80	95	16	0.05	0.225	5	55	LFCSP	0.57
	ADA4691-4	4															LFCSP	0.90
CMOS	AD8665	1	5/16	SS	4	3.5	2.5	3	90	98	130	10	0.1	1.550	1	140	SOT-23/SOIC	0.83
	AD8666	2															MSOP/SOIC	0.93
	AD8668	4															SOIC/TSSOP	1.75
CMOS	AD8603	1	1.8/6	RRIO	0.4	0.1	0.3	1	85	80	112	25	0.05	0.040	1	80	SOT-23	0.68
	AD8607	2															MSOP/SOIC	1.02
	AD8609	4															SOIC/TSSOP	1.85
CMOS	AD8601A	1	2.7/6	RRIO	8.2	5.2	0.5	2	74	67	89	33	0.05	1.200	60	30	SOT-23	0.62
	AD8602A	2															MSOP/SOIC	0.83
	AD8604A	4															SOIC/TSSOP	1.13
CMOS	AD8605	1	2.7/6	RRIO	10	5	0.3	1	85	80	109	8	0.01	1.200	1	80	WLCSP/SOT-23	0.68
	AD8606	2															WLCSP/MSOP/SOIC	1.19
	AD8608	4															SOIC/TSSOP	1.58
CMOS	AD8500	1	1.8/5.5	RRIO	0.007	0.004	1	3	75	90	98	190	0.1	0.001	10	5	SC70	0.71
CMOS	AD8615	1	2.7/6	RRIO	24	12	0.5	1.5	80	70	105	10	0.05	1.300	1	150	SOT-23	0.76
	AD8616	2															MSOP/SOIC	1.29
	AD8618	4															SOIC/TSSOP	2.29
CMOS	AD8655	1	2.7/5.5	RRIO	28	11	0.25	0.4	85	88	100	2.7 ²		4.500	10	220	MSOP/SOIC	0.71
	AD8656	2															MSOP/SOIC	1.11
CMOS	AD8651	1	2.7/5.5	RRIO	50	41	0.35	4	80	76	100	4.5 ²	0.025	14.000	10	80	MSOP/SOIC	1.13
	AD8652	2															MSOP/SOIC	1.99
CMOS	AD8657	2	2.7/18	RRIO	0.175	0.3	0.3	4	95	105	110	50		0.022	5	10	MSOP/SOIC	0.95
	AD8659	3															SOIC/LFCSP	1.35
CMOS	ADA4505-1	2	1.8/5.5	RRIO	0.050	0.006	3	2	90	100	105	65	0.02	0.010	2	40	WLCSP/SOT-23	0.55
	ADA4505-2	1															WLCSP/MSOP	0.67
	ADA4505-4	4															WLCSP/TSSOP	1.15
CMOS	AD8505	1	1.8/5.5	RRIO	0.095	0.013	2.5	2	90	100	105	45	0.015	0.020	10	45	WLCSP/SOT-23	0.47
	AD8506	2															WLCSP/MSOP	0.57
	AD8508	4															WLCSP/TSSOP	1.02
CMOS	AD8628	1	2.7/6	RRIO	2.5	1	0.005	0.002	120	115	125	22		0.850	100	50	SOT-23/SOIC	0.96
	AD8629	2															MSOP/SOIC	1.47
	AD8630	4															SOIC/TSSOP	2.73
CMOS	ADA4528-1	1	2.2/5.5	RRIO	4	0.4	0.003	0.015	115	120	130	5.3	0.1	1.500	100	25	MSOP/LFCSP	1.15
	ADA4528-2	2															MSOP/LFCSP	1.90
CMOS	ADA4051-1	1	1.8/5.5	RRIO	0.125	0.06	0.015	0.02	110	110	115	95	0.1	0.017	70	15	SC70/SOT-23	0.93
	ADA4051-2	2															MSOP/LFCSP	1.47
CMOS	AD8538	1	2.7/5.5	RRIO	0.43	0.35	0.013	0.03	115	105	115	50		0.180	25	25	SOT-23/SOIC	0.90
	AD8539	2															MSOP/SOIC	1.31
CMOS	AD8551	1	2.7/6	RRIO	1.5	0.4	0.005	0.005	120	120	125	42		0.975	50	50	MSOP/SOIC	1.22
	AD8552	2															SOIC/TSSOP	1.94
	AD8554	4															SOIC/TSSOP	3.43
CMOS	AD8571	1	2.7/6	RRIO	1.5	0.4	0.005	0.005	120	120	125	51		0.850	50	50	MSOP/SOIC	1.11
	AD8572	2															SOIC/TSSOP	1.78
	AD8574	4															SOIC/TSSOP	3.40
CMOS	AD8515	1	1.8/6	RRIO	5	2.7	6	4	60	65	113	22	0.05	0.550	30	20	SC70/SOT-23	0.28
CMOS	AD8613	1	1.8/5.5	RRIO	0.4	0.1	2.2	1	68	67	107	25	0.05	0.040	1	80	SC70/SOT-23	0.46
	AD8617	2															MSOP/SOIC	0.71
	AD8619	4															SOIC/TSSOP	1.11
CMOS	AD8602	2	2.7/6	RRIO	8.2	5.2	6	2	56	56	86	33	0.05	1.200	200	30	MSOP/SOIC	0.44
	AD8604	4															SOIC/TSSOP	0.90
CMOS	AD8502	2	1.8/5.5	RRIO	0.007	0.004	3	5	67	85	98	190	0.1	0.001	10	5	SOT-23	0.70
	AD8504	4															TSSOP	1.00
CMOS	AD8646	2	2.7/6	RRIO	24	11	2.5	1.8	67	63	104	8		1.500	1	120	MSOP/SOIC	0.61
	AD8648	4															SOIC/TSSOP	0.88
CMOS	AD8647	2	2.7/6	RRIO	24	11	2.5	1.8	67	63	104	8		1.500	1	120	MSOP	0.71
CMOS	AD8591	1	2.7/6	RRIO	3	5	25	20	38	45	83	45	0.05	0.700	50	250 ²	SOT-23	0.29
	AD8592	2															SOIC	0.39
	AD8594	4															SOIC/TSSOP	0.57
CMOS	AD8531	1	2.7/6	RRIO	3	5	25	20	38	45	83	45	0.05	0.700	50	250 ²	SC70/SOT-23	0.27
	AD8532	2															MSOP/SOIC/TSSOP	0.43
	AD8534	4															SOIC/TSSOP	0.60

¹ RRIO: rail-to-rail input/output, RRO: rail-to-rail output, S: single supply.

² Check data sheet for test conditions and actual product specification—may be different for single/dual/quad amplifiers.

Single-Supply and Rail-to-Rail Output Amplifiers (continued)

Process	Part Number	No. of Amps	Supply Voltage (Min/Max)	Rail-to-Rail ¹	BW @ A _{CL} Min (MHz)	Slew Rate (V/μs)	V _{OS} Max (mV)	TcV _{OS} (μV/°C Typ)	CMRR Min (dB)	PSRR Min (dB)	A _{VO} Min (dB)	Noise (nV/√Hz) @ 1 kHz	Noise (pA/√Hz) @ 1 kHz	I _S /Amp (mA Max)	I _b Max (pA)	ISC (mA)	Packaging	Price @ 1k (DEM \$US)
CMOS	AD8541	1	2.7/6	RRIO	1	0.92	6	4	40	65	86	40	0.1	0.045	60	60	SC70/SOT-23/SOIC	0.27
	AD8542	2															MSOP/SOIC/TSSOP	0.38
	AD8544	4															SOIC/TSSOP	0.54
CMOS	ADA4665-2	2	5/16	RRIO	1.2	1	6	3	55	70	85	32	0.400	1	10	MSOP/SOIC	0.35 0.54	
CMOS	AD8661	1	5/16	SS	4	3.5	0.16	4	90	95	106	12	0.1	1.550	1	140	SOIC/LFCSP	1.08
	AD8662	2															MSOP/SOIC	1.37
	AD8664	4															SOIC/TSSOP	2.23
JFET	AD8627	1	±5/±13	SS	5	5	0.75	2.5	76	80	103	16	0.5	0.850	1	15 ²	SC70/SOIC	1.60
	AD8626	2															MSOP/SOIC	2.63
	AD8625	4															SOIC/TSSOP	4.09
JFET	AD8641	1	±2.5/±13	SS	3.5	3	0.75	2.5	90	90	106	27.5	0.001	0.290	1	12 ²	SC70/SOIC	1.47
	AD8642	2															MSOP/SOIC	2.35
	AD8643	4															SOIC/LFCSP	3.85
JFET	AD820A	1	±2.5/±18	SS	1.9	3	2	2	70	70	114	16	0.008	0.900	25	45	MSOP/SOIC/PDIP	1.82
	AD822A	2															MSOP/SOIC/PDIP	2.84
	AD824A	4															SOIC	4.87
JFET	AD820B	1	±2.5/±18	SS	1.9	3	1	2	74	70	114	16	0.008	0.900	10	45	SOIC/PDIP	2.66
	AD822B	2															MSOP/SOIC/PDIP	4.23
JFET	ADA4610-1A*	1	±4.5/±18	RRO	9.8	25	1	1	106	106	104	7.3		1.850	25	79	MSOP/SOIC	TBD
	ADA4610-2	2															SOIC/LFCSP	1.43
	ADA4610-4*	4															SOIC/TSSOP	TBD

*Prerelease

¹ RRIO: rail-to-rail input/output, RRO: rail-to-rail output, S: single supply.

² Check data sheet for test conditions and actual product specification—may be different for single/dual/quad amplifiers.

Precision Amplifiers ($V_{OS} < 1$ mV, Bandwidth < 50 MHz)

Rail-to-Rail Input/Output Amplifiers

ADA4661-2: 18 V, Precision, Low Power RRIO CMOS Amplifier

The ADA4661-2 is a dual, low power, precision, rail-to-rail input/output amplifier optimized for high bandwidth, low power, and wide operating supply voltage range applications. It is an excellent selection for applications using single ended supplies of 3.3 V, 5 V, 10 V, 12 V, and 15 V and dual supplies of ± 2.5 V, ± 3.3 V, and ± 5 V.

Features

- Low power at high voltage (18 V): 725 μ A max
- Low offset voltage: 300 μ V max over input CMV
- Low input bias current: 10 pA max
- Unity-gain crossover: 4 MHz typical
- Rail-to-rail input/output
- 3 V to 18 V single supply or ± 1.5 V to ± 9 V dual-supply operation
- Unity-gain stable

Applications

- Current shunt monitors
- Active filters
- Portable medical equipment
- Buffer/level shifting
- High impedance sensor interfaces
- Battery-powered instrumentation

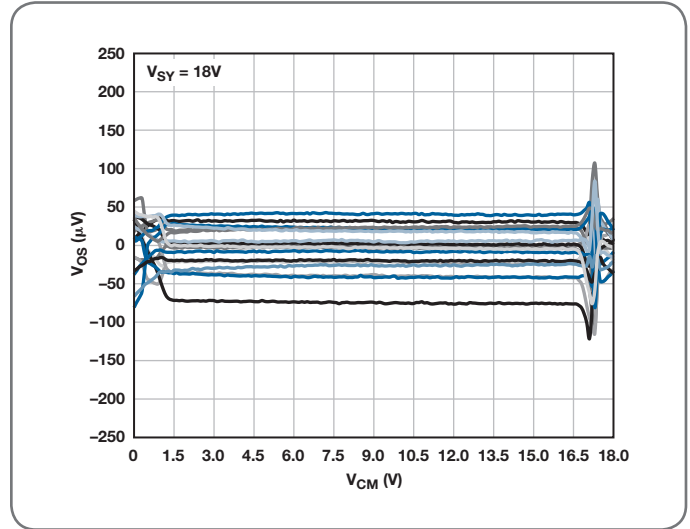

Input offset voltage vs. common-mode voltage.

Rail-to-Rail Input/Output Amplifiers

Process	Part Number	No. of Amps	Supply Voltage (Min/Max)	Rail-to-Rail ¹	BW @ A _{cl} Min (MHz)	Slew Rate (V/ μ s)	V _{OS} (mV Max)	TcV _{OS} (μ V/ $^{\circ}$ C Typ)	CMRR Min (dB)	PSRR Min (dB)	A _{v0} Min (dB)	Noise (nV/ \sqrt Hz) @ 1 kHz	I _q /Amp (mA Max)	I _b Max	Packaging	Price @ 1k (OEM \$US)
CMOS	ADA4528-1	1	2.2/5.5	RRIO	4	0.4	0.0025	0.015	115	120	130	5.3	1.500	100 pA	MSOP/LFCSP	0.98
	ADA4528-2	2														1.52
CMOS	AD8605	1	2.7/6	RRIO	10	5	0.3	1	85	80	109	8	1.200	1 pA	Micro CSP/SOT-23	0.68
	AD8606	2													Micro CSP/MSOP/SOIC	1.19
	AD8608	4													SOIC/TSSOP	1.58
CMOS	AD8646	2	2.7/6	RRIO	24	11	2.5	1.8	67	63	104	8	1.500	1 pA	MSOP/SOIC	0.61
	AD8648	4													SOIC/TSSOP	0.88
CMOS	AD8647 SD	2	2.7/6	RRIO	24	11	2.5	1.8	67	63	104	8	1.500	1 pA	MSOP	0.71
CMOS	AD8615	1	2.7/6	RRIO	24	12	0.5	1.5	80	70	105	10	1.300	1 pA	SOT-23	0.76
	AD8616	2													MSOP/SOIC	1.29
	AD8618	4													SOIC/MSSOP	2.29
CMOS	AD8628	1	2.7/6	RRIO	2.5	1	0.005	0.002	120	115	125	22	0.850	100 pA	SOT-23/SOIC	0.96
	AD8629	2													MSOP/SOIC	1.47
	AD8630	4													SOIC/TSSOP	2.73
CMOS	AD8515	1	1.8/6	RRIO	5	2.7	6	4	60	65	113	22	0.550	30 pA	SC70/SOT-23	0.28
CMOS	AD8603	1	1.8/6	RRIO	0.4	0.1	0.3	1	85	80	112	25	0.040	1 pA	SOT-23	0.68
	AD8607	2													MSOP/SOIC	1.02
	AD8609	4													SOIC/MSSOP	1.85
Bipolar	ADA4091-2	2	$\pm 1.35/\pm 18$	RRIO	1.27	0.46	0.25	2.5	104	108	116	25	0.250	55 nA	SOIC/LFCSP	2.22
	ADA4091-4	4													LFCSPTSSOP	3.60
CMOS	AD8613	1	1.8/5.5	RRIO	0.4	0.1	2.2	1	68	67	107	25	0.040	1 pA	SC70/SOT-23	0.46
	AD8617	2													MSOP/SOIC	0.71
	AD8619	4													SOIC/TSSOP	1.11

¹ RRIO: rail-to-rail input/output, RRO: rail-to-rail output, SS: single supply (IVR includes $-V_{SY}$).

Rail-to-Rail Input/Output Amplifiers (continued)

Process	Part Number	No. of Amps	Supply Voltage (Min/Max)	Rail-to-Rail ¹	BW @ A _{cl} Min (MHz)	Slew Rate (V/μs)	V _{OS} (mV Max)	TcV _{OS} (μV/°C Typ)	CMRR Min (dB)	PSRR Min (dB)	A _{VO} Min (dB)	Noise (nV/√Hz) @ 1 kHz	I _r /Amp (mA Max)	I _s Max	Packaging	Price @ 1k (OEM \$US)
Bipolar	AD8565	1	4.5/16	RRIO	5	6	10	5	54	70	69	26	0.850	600 nA	SC70	0.56
	AD8566	2													MSOP	0.71
	AD8567	4													LFCSP/TSSOP	0.93
CBCMOS	OP196	1	3/15	RRIO	0.45	0.3	0.3	1.5	65 ²	110	109	26	0.060	50 nA	SOIC	1.51
	OP296	2													SOIC/TSSOP/PDIP	1.89
	OP496	4													SOIC/TSSOP/PDIP	2.71
BiPolar	ADA4092-4	4	±1.35/±18	RRIO	1.4	0.4	1.5	2.5	90	98	116	30	0.250	60 nA	TSSOP	2.50
CMOS	ADA4665-2	2	5/16	RRIO	1.2	1	6	3	55	70	85	32	0.400	1 pA	MSOP/SOIC	0.70
CMOS	AD8601A	1	2.7/6	RRIO	8.2	5.2	0.5	2	74	67	89	33	1.200	60 pA	SOT-23	0.62
	AD8602A	2													MSOP/SOIC	0.83
	AD8604A	4													SOIC/TSSOP	1.13
CMOS	AD8602	2	2.7/6	RRIO	8.2	5.2	6	2	56	56	86	33	1.200	200 pA	MSOP/SOIC	0.44
	AD8604	4													SOIC/TSSOP	0.90
CMOS	AD8541	1	2.7/6	RRIO	1	0.92	6	4	40	65	86	40	0.045	60 pA	SC70/SOT-23/SOIC	0.27
	AD8542	2													MSOP/SOIC/TSSOP	0.38
	AD8544	4													SOIC/TSSOP	0.54
CMOS	OP191	1	2.7/12	RRIO	1.5	0.5	0.5	1.1	75	80	88	42	0.420	65 nA	SOIC	1.69
	OP291	2													SOIC	2.22
	OP491	4													SOIC/TSSOP/PDIP	3.60
CMOS	AD8551	1	2.7/6	RRIO	1.5	0.4	0.005	0.005	120	120	125	42	0.975	50 pA	MSOP/SOIC	1.22
	AD8552	2													SOIC/TSSOP	1.94
	AD8554	4													SOIC/TSSOP	3.43
CMOS	AD8657	2	2.7/18	RRIO	0.175	0.3	0.3	4	95	105	110	50	0.022	5 pA	MSOP/SOIC	0.95
	AD8659	4													SOIC/LFCSP	1.35
CMOS	AD8505	1	1.8/5.5	RRIO	0.095	0.013	2.5	2	90	100	105	45	0.020	10 pA	Micro CSP/SOT-23	0.47
	AD8506	2													Micro CSP/MSOP	0.57
	AD8508	4													Micro CSP/TSSOP	1.02
CMOS	AD8591	1	2.7/6	RRIO	3	5	25	20	38	45	83	45	0.700	50 pA	SOT-23	0.29
	AD8592	2													SOIC	0.39
	AD8594	4													SOIC/TSSOP	0.57
CMOS	AD8531	1	2.7/6	RRIO	3	5	25	20	38	45	83	45	0.700	50 pA	SC70/SOT-23	0.27
	AD8532	2													MSOP/SOIC	0.43
	AD8534	4													SOIC/TSSOP	0.60
CMOS	AD8538	1	2.7/5.5	RRIO	0.43	0.35	0.013	0.03	115	105	115	50	0.180	25 pA	SOT-23/SOIC	0.90
	AD8539	2													MSOP/SOIC	1.31
CMOS	AD8571	1	2.7/6	RRIO	1.5	0.4	0.005	0.005	120	120	125	51	0.850	50 pA	MSOP/SOIC	1.11
	AD8572	2													SOIC/TSSOP	1.78
	AD8574	4													SOIC/TSSOP	3.40
CMOS	ADA4505-1	1	1.8/5.5	RRIO	0.050	0.006	3	2	90	100	105	65	0.010	2 pA	Micro CSP/SOT-23	0.41
	ADA4505-2	2													Micro CSP/MSOP	0.57
	ADA4505-4	4													Micro CSP/TSSOP	1.01
CMOS	ADA4051-1	1	1.8/5.5	RRIO	0.125	0.06	0.015	0.02	110	110	115	95	0.017	70 pA	SC70/SOT-23	0.93
	ADA4051-2	2													MSOP/LFCSP	1.47
CMOS	AD8500	1	1.8/5.5	RRIO	0.007	0.004	1	3	75	90	98	190	0.001	10 pA	SC70	0.71
CMOS	AD8502	2	1.8/5.5	RRIO	0.007	0.004	3	5	67	85	98	190	0.001	10 pA	SOT-23	0.70
	AD8504	4													TSSOP	1.00
CMOS	AD8655	1	2.7/5.5	RRIO	28	11	0.25	0.4	85	88	100	2.7 ²	4.500	10 pA	MSOP/SOIC	0.71
	AD8656	2													MSOP/SOIC	1.11
CMOS	AD8651	1	2.7/5.5	RRIO	50	41	0.35	4	80	76	100	4.5 ²	14.000	10 pA	MSOP/SOIC	1.13
	AD8652	2													MSOP/SOIC	1.99
HVBP2	ADA4084-1*	1	±2/36	RRIO	9.9	4.6	0.1	0.5	106	110	110	3.9	0.750	300 nA	SOT23/LFCSP	1.50
	ADA4084-2	2													MSOP/SOIC/LFCSP	2.85
	ADA4084-4	4													LFCSP/TSSOP	4.45
	ADA4500-2	2	2.7/6	RRIO	10	5.5	0.12	0.9	95	98	105	14.5	1.750	2 pA	MSOP/LFCSP	0.98
CMOS	ADA4661-2	2	3/20.5	RRIO	4.5	2.2	0.15	2.1	100	120	120	18	0.725	3 pA	SOIC/LFCSP	1.13
CMOS	ADA4666-2	2	3/20.5	RRIO	4.5	2.2	2.2	3	64	120	105	18	0.725	3 pA	SOIC/LFCSP	0.85
Bipolar	AD8519	12	2.7/12	SS	8	2.9	1.1	2	70 ²	60	94	10	1.200	300 nA	SC70/SOT-23/SOIC	0.94
	AD8529														MSOP/SOIC	1.24

*Prerelease

¹ RRIO: rail-to-rail input/output, RRO: rail-to-rail output, SS: single supply (IVR includes -V_{SS}).

² Check data sheet for test conditions and actual product specification—may be different for single/dual/quad amplifiers for part numbers with ² mark.

Precision Amplifiers ($V_{OS} < 1 \text{ mV}$, Bandwidth $< 50 \text{ MHz}$)

Low Cost Amplifiers

ADA4666-2: 18 V, Low Power, CMOS RRIO Amplifier

The ADA4666-2 is a dual, rail-to-rail input/output amplifier optimized for lower power budget designs. The ADA4666-2 performance is guaranteed at 3.0 V, 10 V, and 18 V power supply voltages. It is an excellent selection for applications that use single-ended supplies of 3.3 V, 5 V, 10 V, 12 V, and 15 V, and dual supplies of $\pm 2.5 \text{ V}$, $\pm 3.3 \text{ V}$, and $\pm 5 \text{ V}$.

Features

- Low power at high voltage (18 V): 725 μA max
- Low input bias current: 15 pA max
- 4 MHz bandwidth typical
- Offset voltage of 2.2 mV over entire common-mode range
- Single-supply operation: 3 V to 18 V
- Dual-supply operation: $\pm 1.5 \text{ V}$ to $\pm 9 \text{ V}$
- Unity-gain stable

Applications

- Current monitors
- Active filters
- Portable medical equipment
- Buffer/level shifting
- High impedance sensor interface
- Battery-powered instrumentation

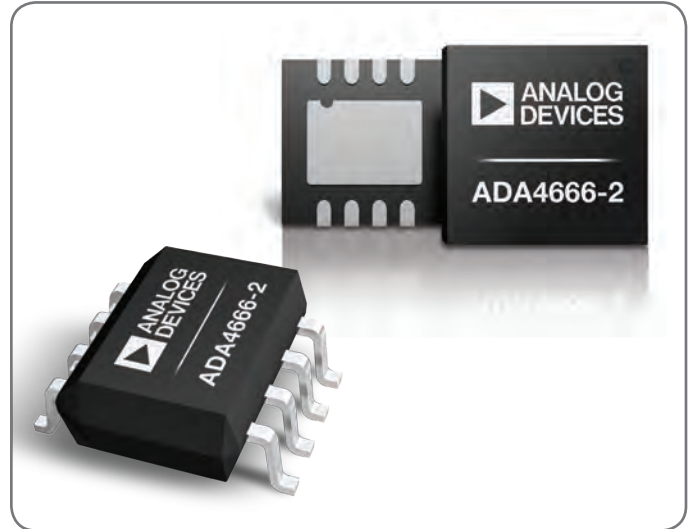

Low Cost Amplifiers

Process	Part Number	No. of Amps	Supply Voltage (Min/Max)	Rail-to-Rail ¹	BW @ A _{cl} Min (MHz)	Slew Rate (V/μs)	V _{os} Max (mV)	TcV _{os} (μV/°C Typ)	CMRR Min (dB)	PSRR Min (dB)	A _{vo} Min (dB)	Noise (nV/√Hz) @ 1 kHz	I _q /Amp (mA Max)	I _b Max	Packaging	Price @ 1k (DEM \$US)
CMOS	ADA4666-2	2	3/20.5	RRIO	4.5	2.2	2.2	3	64	120	105	18	0.725	3 pA	SOIC/LFCSP	0.85
CMOS	AD8515	1	1.8/6	RRIO	5	2.7	6	4	60	65	113	22	0.550	30 pA	SC70/SOT-23	0.28
CMOS	ADA4665-2	2	5/16	RRIO	1.2	1	6	3	55	70	85	32	0.400	1 pA	MSOP/SOIC	0.70
CMOS	AD8541	1	2.7/6	RRIO	1	0.92	6	4	40	65	86	40	0.045	60 pA	SC70/SOT-23	0.27
	AD8542	2													MSOP/SOIC	0.38
	AD8544	4													SOIC/TSSOP	0.54
CMOS	AD8531	1	2.7/6	RRIO	3	5	25	20	38	45	83	45	0.700	50 pA	SC70/SOT-23	0.27
	AD8532	2													MSOP/SOIC	0.43
	AD8534	4													SOIC/TSSOP	0.60
CMOS	AD8591	1	2.7/6	RRIO	3	5	25	20	38	45	83	45	0.700	50 pA	SOT-23	0.29
	AD8592	2													SOIC	0.39
	AD8594	4													SOIC/TSSOP	0.57
JFET	ADTL082A	2	±4/±18		5	20	5.5	10	80	80	100	16	1.800	100 pA	MSOP/SOIC	0.43
	ADTL084A	4													SOIC/TSSOP	0.92
CMOS	AD8602	2	2.7/6	RRIO	8.2	5.2	6	2	56	56	86	33	1.200	200 pA	MSOP/SOIC	0.44
	AD8604	4													SOIC/TSSOP	0.90
CMOS	AD8613	1	1.8/5.5	RRIO	0.4	0.1	2.2	1	68	67	107	25	0.040	1 pA	SC70/SOT-23	0.46
	AD8617	2													MSOP/SOIC	0.71
	AD8619	4													SOIC/TSSOP	1.11
CMOS	AD8691	1	2.7/6	SS	10	5	2	1.3	70	80	108	8	1.050	1 pA	SC70/SOT-23	0.44
	AD8692	2													MSOP/SOIC	0.60
	AD8694	4													SOIC/TSSOP	0.80
CMOS	ADA4505-1	1	1.8/5.5	RRIO	0.050	0.006	3	2	90	100	105	65	0.010	2 pA	Micro CSP/SOT-23	0.41
	ADA4505-2	2													Micro CSP/MSOP	0.57
	ADA4505-4	4													Micro CSP/TSSOP	1.01
CMOS	ADA4692-2	2	2.7/6	SS	3.6	1.3	2.5	1	75	80	95	16	0.225	5 pA	SOIC/LFCSP	0.55
	ADA4692-4	4													TSSOP	0.85
Bipolar	AD8565	1	4.5/16	RRIO	5	6	10	5	54	70	69	26	0.850	600 nA	SC70	0.56
	AD8566	2													MSOP	0.71
	AD8567	4													LFCSP/TSSOP	0.93
CMOS	ADA4691-2	2	2.7/6	SS	3.6	1.3	2.5	1	75	80	95	16	0.225	5 pA	WLCSP/LFCSP	0.57
	ADA4691-4	4													LFCSP	0.90
CMOS	AD8505	1	1.8/5.5	RRIO	0.095	0.013	2.5	2	90	100	105	45	0.020	10 pA	Micro CSP/SOT-23	0.47
	AD8506	2													Micro CSP/MSOP	0.57
	AD8508	4													Micro CSP/TSSOP	1.02
CMOS	AD8646	2	2.7/6	RRIO	24	11	2.5	1.8	67	63	104	8	1.500	1 pA	MSOP/SOIC	0.61
	AD8648	4													SOIC/TSSOP	0.88
CMOS	AD8601A	1	2.7/6	RRIO	8.2	5.2	0.5	2	74	67	89	33	1.200	60 pA	SOT-23	0.62
	AD8602A	2													MSOP/SOIC	0.83
	AD8604A	4													SOIC/TSSOP	1.13
CMOS	AD8603	1	1.8/6	RRIO	0.4	0.1	0.3	1	85	80	112	25	0.040	1 pA	SOT-23	0.68
	AD8607	2													MSOP/SOIC	1.02
	AD8609	4													SOIC/TSSOP	1.85
CMOS	AD8605	1	2.7/6	RRIO	10	5	0.3	1	85	80	109	8	1.200	1 pA	Micro CSP/SOT-23	0.68
	AD8606	2													Micro CSP/MSOP	1.19
	AD8608	4													Micro CSP/TSSOP	1.58
CMOS	AD8502	2	1.8/5.5	RRIO	0.007	0.004	3	5	67	85	98	190	0.001	10 pA	SOT-23	0.70
	AD8504	4													TSSOP	1.00

¹ RRIO: rail-to-rail input/output, RRO: rail-to-rail output, SS: single supply (IVR includes -V_{ss}).

High Speed Amplifiers (BW > 50 MHz)

Differential Amplifiers

ADA4940-1/ADA4940-2: Ultralow Power, Low Distortion ADC Driver

The ADA4940-1 and ADA4940-2 are low noise, low distortion fully differential amplifiers with very low power consumption. They are an ideal choice for driving low power, high resolution, high performance SAR and Σ - Δ analog-to-digital converters (ADCs) with resolutions up to 16 bits from dc to 1 MHz on only 1.25 mA of quiescent current. The adjustable level of the output common-mode voltage allows the ADA4940-1/ADA4940-2 to match the input common-mode voltage of multiple ADCs. The internal common-mode feedback loop provides exceptional output balance, as well as suppression of even-order harmonic distortion products.

Features

- Small signal bandwidth: 260 MHz
- Ultralow power: 1.25 mA
- Extremely low harmonic distortion
 - -122 dB THD at 50 kHz
 - -96 dB THD at 1 MHz
- Low input voltage noise: 3.9 nV/ $\sqrt{\text{Hz}}$
- 0.35 mV maximum offset voltage
- Balanced outputs
- Settling time to 0.1%: 34 ns
- Rail-to-rail output: $-V_S + 0.1 \text{ V}$ to $+V_S - 0.1 \text{ V}$
- Adjustable output common-mode voltage
- Flexible power supplies: 3 V to 7 V (LFCSP)
- Disable pin to reduce power consumption
- ADA4940-1 is available in LFCSP and SOIC packages

Applications

- Low power PulSAR[®]/SAR ADC drivers
- Single-ended-to-differential conversion
- Differential buffers
- Line drivers
- Medical imaging
- Industrial process controls
- Portable electronics

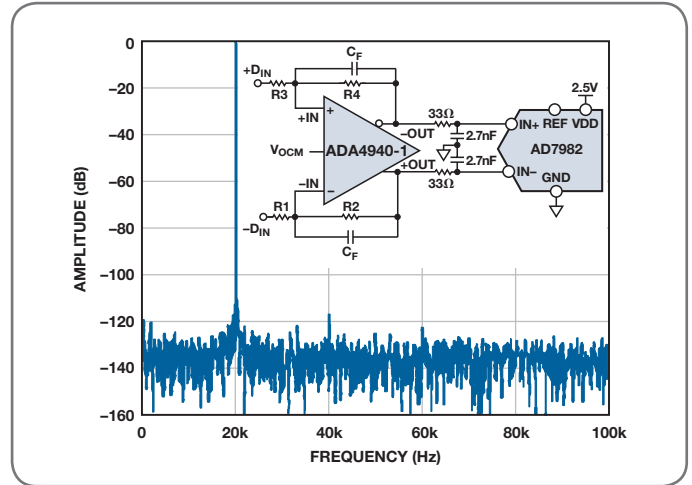

Voltage noise spectral density.

Differential Amplifiers

Part Number	No. of Amps	Disable	Supply Voltage (V)	Rail-to-Rail ¹	A _{CL} Min	BW @ A _{CL} Min (MHz)	Slew Rate (V/ μ s)	Distortion SFDR ¹ @ BW		Noise (nV/ $\sqrt{\text{Hz}}$)	V _{OS} Max (mV)	I _b (μ A Max)	I _s /Amp (mA Typ)	I _{OUT} (mA)	Temperature Range ²	Packaging	Price @ 1k (OEM \$US)
								(dBc)	(MHz)								
ADA4927-1	1	•	5, ± 5		1	2300	5000	-91	70	1.4	1.3	15	20 mA	65	H	LFCSP	3.79
ADA4927-2	2	•															6.29
ADA4930-1	1	•	3 to 5.25		1	1350	3400	-88	30	1.15	3.1	24	34	30		LFCSP	3.79
ADA4930-2	2	•															6.29
ADA4932-1	1	•	3, 5, ± 5		1	560	2800	-90	20	3.6	2.2	5.2	9.6	80	H	LFCSP	2.95
ADA4932-2	2	•															5.29
ADA4937-1	1	•	3, 5		1	1900	6000	-84	70	2.2	2.5	30	39.5	100	I	LFCSP	3.79
ADA4937-2	2	•															5.69
ADA4938-1	1	•	5, ± 5		1	1000	4700	82	50	2.6	1	18	37	75	I	LFCSP	3.79
ADA4938-2	2	•															5.69
ADA4939-1	1	•	3, 5		2	1400	6800	-77	100	2.3	3.4	26	36.5	100	H	LFCSP	3.79
ADA4939-2	2	•															5.69
ADA4940-1	1	•	3, 5, ± 5	RRO	1	230	90	103	1	3.9	0.25	1	1.25	45	H	SOIC/LFCSP	1.59
ADA4940-2	2	•	3, 5													LFCSP	2.59
ADA4950-1	1	•	3, 5, ± 5		1	750	2900	-98	20	9.2 RTO	2.5	N/A	9.5	114	H	LFCSP	2.99
ADA4950-2	2	•															5.29
AD8139	1	•	3, 5, ± 5	RRO	1	410	800	-85	5	2.25	0.5	8	24.5	100	H5	SOIC/LFCSP	3.75
AD8131	1	•	3, 5, ± 5		2	400	2000	-68	5	25	7	6	11.5	60	H	SOIC/MSOP	1.82
AD8132	1	•	3, 5, ± 5		1	350	1200	-83	5	8	3.5	7	12	70	H5	SOIC/MSOP	1.67
AD8138	1	•	3, 5, ± 5		1	320	1150	-85	20	5	2.5	7	20	95	I	SOIC/MSOP	3.75
AD8137	1	•	3, 5, ± 5	RRO	1	110	450	-90	0.5	8.25	2.6	1	3.2	20	H5	SOIC/LFCSP	1.10
ADA4922-1	1	•	5, ± 5 , ± 12		2	38	260	-99	0.1	12 RTO	1.1	3.5	9.4	40	I	SOIC/LFCSP	3.63
ADA4941-1	1	•	3, 5, ± 5	RRO	2	31	24.5	-110	0.1	10.2 RTO	0.8	3	2.3	25	I	SOIC/LFCSP	2.42
ADA4960-1	1	•	5		2	5000	8700	-73	1000	4.8	20	20	60	17.5	I	LFCSP	6.95

¹ RRIO: rail-to-rail input/output, RRO: rail-to-rail output, SS: single supply (IVR includes $-V_{SS}$).

² Temperature range: H = extended industrial (-40°C to $+125^\circ\text{C}$), I = industrial (-40°C to $+85^\circ\text{C}$).

RTO: referred to output.

High Speed Amplifiers (BW > 50 MHz)

Low Noise/Low Distortion Amplifiers

ADA4896-2/ADA4897-1: Gain Stable, Low Power, 1 nV/√Hz, Rail-to-Rail Output Operational Amplifiers

The ADA4896-2/ADA4897-1 are unity gain stable, low noise, rail-to-rail output, high speed voltage feedback amplifiers that have a quiescent current of 3 mA. With the 1/f noise of 2 nV/√Hz @ 10 Hz and a spurious-free dynamic range of -95 dBc @ 2 MHz, the ADA4896-2/ADA4897-1 are an ideal solution in a variety of applications, including ultrasound, automatic test equipment (ATE), active filters, and 16-bit PuISAR ADC drivers.

Features

- Unity-gain stable
- Ultralow noise: 1 nV/√Hz, 9 pA/√Hz
- Ultralow distortion: -110 dBc at 100 kHz
- High speed
 - -3 dB bandwidth: 200 MHz (G = +1)
 - Slew rate: 100 V/μs
- Offset voltage: 500 μV
- Low input bias current: 10 μA
- Wide supply voltage range: 2.7 V to 10 V
- Supply current: 3 mA

Applications

- Analog-to-digital drivers
- Instrumentation
- Active filters
- IF and baseband amplifiers
- DAC buffers
- Optical electronics
- Ultrasound

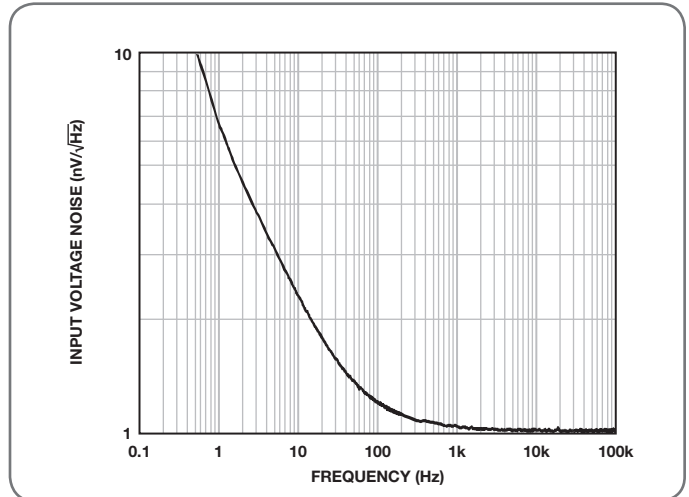

Voltage noise vs. frequency.

Low Noise/Low Distortion Amplifiers

Part Number	No. of Amps	Disable	Supply Voltage (V)	Rail-to-Rail ¹	A _{CL} Min	BW @ A _{CL} Min (MHz)	Slew Rate (V/μs)	Distortion SFDR ¹ @ BW		Noise (nV/√Hz)	V _{OS} Max (mV)	I _B (μA Max)	I _S /Amp (mA Typ)	I _{OUT} (mA)	Temperature Range ²	Packaging	Price @ 1k (OEM \$US)
								(dBc)	(MHz)								
AD8099	1	•	5, ±5		2	700	1350	-92	10	0.95	0.5	1	15	40	H ³	SOIC/LFCSP	2.00
ADA4899-1	1	•	5, ±5		1	600	310	-123	0.5	1	0.23	1	14.7	40	H ³	SOIC/LFCSP	1.91
ADA4857-1	1	•	5, ±5		1	850	2800	-88	10	4.4	4.5	3.3	5	50	H	SOIC/LFCSP	1.49
ADA4857-2	2	•		2.53													
ADA4896-2	2		3 to 10	RRIO	1	200	100	110	0.1	1	0.5	10	3	90	H	LFCSP/MSOP	3.21
ADA4897-1	1	•	3 to 10	RRO	1	200	100	110	0.1	1	0.75	10	3	90	H	SOIC/SOT-23/MSOP	1.89
ADA4897-2	2	•															3.21
ADA4898-1	1		±5, ±12, ±15		1	65	55	-116	0.1	0.9	0.12	0.4	8.1	40	H	SOIC	2.29
ADA4898-2	2			3.21													
ADA4841-1	1	•	2.7, 5, ±5	RRO	1	80	13	-105	0.1	2.1	0.5	5.3	1.2	60	H ³	SOT-23/SOIC MSOP	1.59
ADA4841-2	2	•															2.32
AD8021	1	•	5, ±5, ±12		1	560	130	-93	1	2.1	1	11.3	7.8	70	I	SOIC/MSOP	1.31
AD8022	2		5, ±5, ±12		1	130	50	-95	1	2.5	6	5	4	55	I	SOIC/MSOP	2.38
AD8045	1		5, ±5		1	1000	1350	-95	10	3	1	6.3	16	70	H ³	SOIC/LFCSP	1.41
AD8048	1		5, ±5		2	260	1000	-72	5	3.8	3	3.5	6.6	50	I	SOIC	2.30
AD8047	1		5, ±5		1	250	750	-78	5	5.2	3	3.5	6.6	50	I	SOIC	2.53

¹ RRIO: rail-to-rail input/output, RRO: rail-to-rail output, SS: single supply (IVR includes -V_{SV}).

² Temperature range: H = extended industrial (-40°C to +125°C), I = industrial (-40°C to +85°C).

³ Recommended for automotive (from high speed amplifiers selection guide).

High Speed Amplifiers (BW > 50 MHz)

Low Cost Amplifiers

ADA4891-1/ADA4891-2/ADA4891-3/ADA4891-4: Low Cost CMOS, High Speed, Rail-to-Rail Operational Amplifiers

The ADA4891-1 (single), ADA4891-2 (dual), ADA4891-3 (triple), and ADA4891-4 (quad) are CMOS high speed amplifiers that offer high performance at a low cost. The amplifiers feature true single-supply capability, with an input voltage range that extends 300 mV below the negative rail. They are ideal for imaging applications, such as consumer video, CCD buffers, and contact image sensor and buffers.

Features

- High speed and fast settling
 - -3 dB bandwidth: 220 MHz ($G = +1$)
 - Slew rate: 170 V/ μ s
 - Settling time to 0.1%: 28 ns
- Video specifications ($G = +2$, $R_L = 150 \Omega$)
 - 0.1 dB gain flatness: 25 MHz
 - Differential gain error: 0.05%
 - Differential phase error: 0.25°
- Single-supply operation
 - Wide supply range: 2.7 V to 5.5 V
 - Output swings to within 50 mV of supply rails
- Low distortion: 79 dBc SFDR at 1 MHz

Applications

- Automotive infotainment and driver assistant systems (qualified for automotive applications)
- Imaging
- Active filters
- Coaxial cable drivers
- Clock buffers
- Photodiode preamps

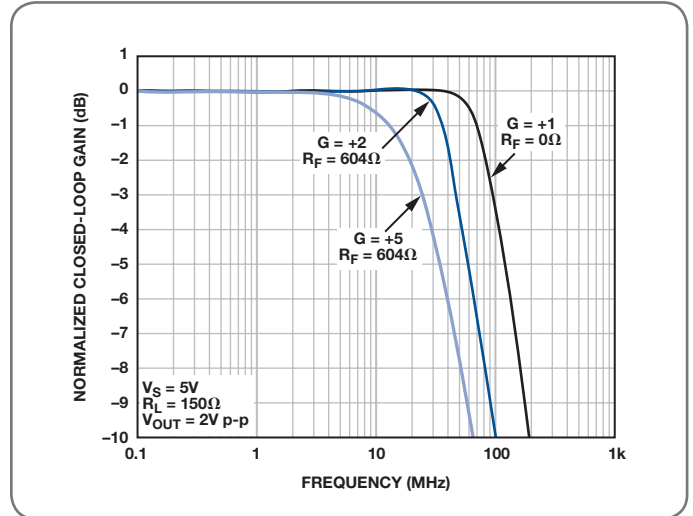

Large signal frequency response vs. gain, $V_S = 5$ V, ADA4891-1/ADA4891-2.

Low Cost Amplifiers

Part Number	No. of Amps	Disable	Supply Voltage (V)	Rail-to-Rail ¹	A_{CL} Min	BW @ A_{CL} Min (MHz)	Slew Rate (V/ μ s)	Distortion SFDR ¹ @ BW		Noise (nV/ \sqrt Hz)	V_{OS} Max (mV)	I_b (μ A Max)	I_S /Amp (mA Typ)	I_{OUT} (mA)	Temperature Range ²	Packaging	Price @ 1k (OEM \$US)
								(dBc)	(MHz)								
ADA4851-1	1	•															0.56
ADA4851-2	2	•	2.7, 5, \pm 5	RRO	1	105	375	-83	1	10	3.5	4	2.9	90	H5	SOT-23/ TSSOP/MSOP	0.70
ADA4851-4	4	•															1.10
AD8038	1	•	3, 5, \pm 5		1	350	425	-90	1	8	3	0.75	1	20	I	SC70/ SOT-23/ SOIC	0.86
AD8039	2	•															1.21
AD8061	1																0.86
AD8063	1	•	2.7, 8	RRO	1	320	650	-62	5	8.5	6	9	6.8	50	I	SOT-23/ SOIC/ MSOP	1.62
AD8062	2																0.86
AD8055	1		\pm 5		1	300	1400	-72	10	6	5	1.2	5.4	60	H5	SOT-23/ SOIC/ MSOP	0.86
AD8056	2																1.62
AD8057	1		3, 5, \pm 5		1	325	1150	-68	5	7	5	2.5	6	30	I5	SOT-23/ SOIC/MSOP	0.86
AD8058	2																1.62
ADA4891-1	1	•															0.49
ADA4891-2	2	•	3, 5	RRO	1	270	166	-80	1	8.8	10	0.002	5	100	H	SOT-23/SOIC/ TSSOP/MSOP	0.69
ADA4891-3	3	•															0.89
ADA4891-4	4	•															1.09

¹ RRO: rail-to-rail input/output, RRO: rail-to-rail output, SS: single supply (IVR includes $-V_{SS}$).

² Temperature range: H = extended industrial (-40°C to $+125^\circ\text{C}$), I = industrial (-40°C to $+85^\circ\text{C}$).

High Speed Amplifiers (BW > 50 MHz)

Rail-to-Rail Input/Output Amplifiers

ADA4805-1: Low Power, High Speed, Operational Amplifier for Driving 16-bit ADC

The ADA4805-1 is a high speed voltage feedback rail-to-rail output amplifier with an exceptionally low quiescent current of 480 μA , making it ideal for low power, high resolution data conversion systems. Despite being low power, the amplifier provides excellent overall performance. It offer high bandwidth of 100 MHz at a gain of 1, high slew rate of 160 $\text{V}/\mu\text{s}$, and a low input offset voltage of 100 μV maximum.

Features

- Dynamic power scaling feature
 - High speed turn-on time: 3 μs (maximum) fully settled
- Ultralow supply current: 500 μA per amplifier
- Supply voltage range: 2.7 V to 10 V
- High speed performance
 - -3 dB bandwidth: 100 MHz
 - Slew rate: 160 $\text{V}/\mu\text{s}$
 - 0.1% settling time: 35 ns
- Rail-to-rail output
- Input common-mode range: $-V_S - 0.1 \text{ V}$ to $+V_S - 1 \text{ V}$
- Low noise: 6.1 $\text{nV}/\sqrt{\text{Hz}}$ at 100 kHz; 0.7 $\text{pA}/\sqrt{\text{Hz}}$ at 100 kHz
- Low distortion: -105 dBc HD2
- Low input bias current: 465 nA typical
- Low input offset voltage; 100 μV (maximum)
- Low input offset voltage drift: 1.8 $\mu\text{V}/^\circ\text{C}$
- Small packaging
 - 6-lead SC70, 6-lead SOT-23

Applications

- High resolution high precision ADC driver
- Battery-powered instrumentation
- Micropower active filters
- Portable point of sales terminals
- Active RFID readers
- Photo multipliers

Rail-to-Rail Input/Output Amplifiers

Part Number	No. of Amps	Disable	Supply Voltage (V)	Rail-to-Rail ¹	A _{CL} Min	BW @ A _{CL} Min (MHz)	Slew Rate (V/ μs)	Distortion		Noise (nV/ $\sqrt{\text{Hz}}$)	V _{OS} Max (mV)	I _B (μA Max)	I _S /Amp (mA Typ)	I _{OUT} (mA)	Temp Range ²	Packaging	Price @ 1k (OEM \$US)
								-105 dBc	0.1 (MHz)								
ADA4805-1	1	•	3.5, ± 5	RRO	1	100	160	-105	0.1	6.1	0.2	0.6	0.5	50	H	SC70/SOT23/LFCSP/MSOP	0.95
AD8031	1		2.7, 5, ± 5	RRIO	1	80	35	-77	0.5	15	1.5	1.2	0.9	15	1	SOT-23/MSOP	1.32
AD8032	2																1.97
ADA4853-1	1	•	3, 5	RRO	1	100	120	-90	1	22	4	1.6	1.4	120	H5	SC70/LFCSP/TSSOP	0.70
ADA4853-2	2	•															0.98
ADA4853-3	3	•															1.19
ADA4855-3	3	•	3, 5	RRO	1	410	870	-84	5	6.8	3	3.8	7.8	40	H	LFCSP	1.39
ADA4856-3	3	•	3, 5	RRO	2	225	800	-92	5	14	3.4	3.8	7.8	7.5	H	LFCSP	1.39
AD8091	1		3, 5, ± 5	RRO	1	110	145	-71	5	16	10	2.5	4.4	45	I	SOT-23/SOIC/MSOP	0.70
AD8092	2																0.90
AD8051	1		3, 5, ± 5	RRO	1	110	170	-72	5	16	11	2.5	4.8	45	H5	SOT-23/SOIC/TSSOP/MSOP	0.86
AD8052	2																1.62
AD8054	4																2.88
AD8029	1	•	2.7, 5, ± 5	RRIO	1	125	62	-74	1	16.5	5	1.3	1.3	20	H	SC70/SOIC/TSSOP/MSOP	0.86
AD8030	2	•															1.21
AD8040	4																1.62
AD8041	1		3, 5, ± 5	RRO	1	170	225	-78	5	15	9.8	3.2	6	50	I	SOIC	1.95
AD8042	2																2.28
AD8044	4																4.00
ADA4850-1	1	•	2.7, 5	RRO	1	175	220	-81	1	10	4.2	4.2	2.5	90	H	LFCSP	0.56
ADA4850-2	2	•															0.70
AD8027	1	•	3, 5, ± 5	RRIO	1	190	100	-120	1	4.3	0.9	6	6.5	25	H5	SOT-23/SOIC/MSOP	1.20
AD8028	2	•															1.91

¹ RRIO: rail-to-rail input/output, RRO: rail-to-rail output, SS: single supply (IVR includes $-V_{SS}$).

² Temp range: H = extended industrial (-40°C to $+125^\circ\text{C}$), I = industrial (-40°C to $+85^\circ\text{C}$).

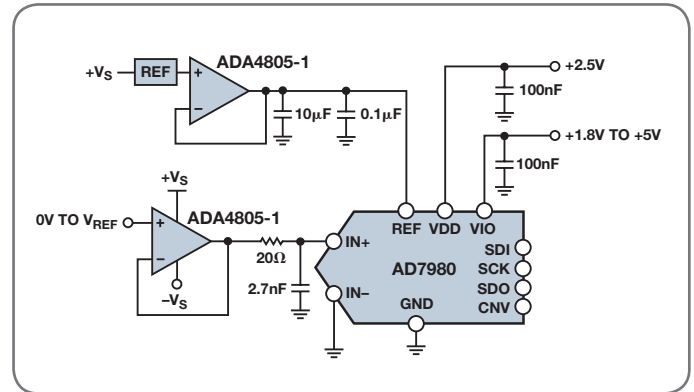

Driving AD7980 16-bit, 1 MSPS SAR ADC with ADA4805-1

High Speed Amplifiers (BW > 50 MHz)

FET Input Amplifiers—FastFET

ADA4817-1/ADA4817-2: Low Noise, 1 GHz FastFET Operational Amplifiers

The ADA4817-1 (single) and ADA4817-2 (dual) are unity-gain stable, ultrahigh speed voltage feedback amplifiers with FET inputs. These amplifiers are developed with ADI's proprietary eXtra Fast complementary Bipolar (XFCB) process, allowing them to achieve ultralow noise and very high input impedances. They are ideal for data acquisition front ends as well as wideband transimpedance applications.

Features

- High speed
 - -3 dB bandwidth (G = 1, R_L = 100 Ω): 1050 MHz
 - Slew rate: 870 V/μs
 - 0.1% settling time: 9 ns
- Low input bias current: 2 pA
- Low input capacitance
 - Common-mode capacitance: 1.3 pF
 - Differential-mode capacitance: 0.1 pF
- Low noise
 - 4 nV/√Hz @ 100 kHz
 - 2.5 fA/√Hz @ 100 kHz
- Low distortion
 - -90 dBc @ 10 MHz (G = 1, R_L = 1 kΩ)
 - Offset voltage: 2 mV maximum

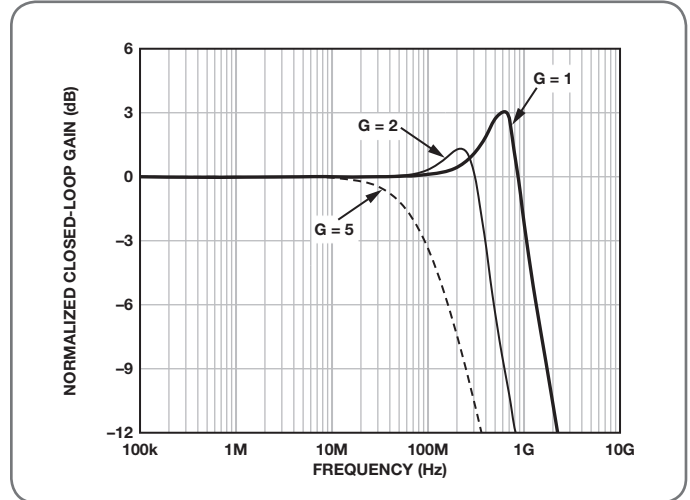

Wideband photodiode preamplifier.

Applications

- Photodiode amplifiers
- Data acquisition front ends
- Instrumentation
- Filters
- ADC drivers
- CCD output buffers

FastFET Amplifiers

Part Number	No. of Amps	Disable	Supply Voltage (V)	Rail-to-Rail ¹	A _{CL} Min	BW @ A _{CL} Min (MHz)	Slew Rate (V/μs)	Distortion SFDR ³ @ BW		Noise (nV/√Hz)	V _{OS} Max (mV)	I _b (μA Max)	I _s /Amp (mA Typ)	I _{OUT} (mA)	Temperature Range ²	Packaging	Price @ 1k (DEM \$US)
								(dBc)	(MHz)								
ADA4817-1	1	•	5, ±5		1	1050	870	-90	10	4	2	20 pA	19	40	H	SOIC/LFCSP	2.95
ADA4817-2	2	•	5, ±5		1	1050	870	-90	10	4	2	20 pA	19	40	H	SOIC/LFCSP	4.98
AD8067	1		5, ±5, ±12	RRO	8	54	500	-95	1	6.6	1	5 pA	6.6	30	I	SOT-23	1.89
AD8065	1		5, ±5, ±12	RRO	1	145	180	-88	1	7	1.5	7 pA	6.4	35	I	SOT-23/MSOP	1.61
AD8066	2		5, ±5, ±12	RRO	1	145	180	-88	1	7	1.5	7 pA	6.4	35	I	SOT-23/MSOP	2.32
AD8033	1		5, ±5, ±12	RRO	1	80	80	-82 ³	1	11	2	11 pA	3.3	25	I	SC70/SOT-23	1.03
AD8034	2		5, ±5, ±12	RRO	1	80	80	-82 ³	1	11	2	11 pA	3.3	25	I	SC70/SOT-23	1.61

¹ RRIO: rail-to-rail input/output, RRO: rail-to-rail output, SS: single supply (IVR includes -V_{SS}).

² Temperature range: H = extended industrial (-40°C to +125°C), I = industrial (-40°C to +85°C).

³ THD: total harmonic distortion.

High Speed Amplifiers (BW > 50 MHz)

Current Feedback Amplifiers

AD8000: 1.5 GHz Ultrahigh Speed Operational Amplifier

The AD8000 is an ultrahigh speed, high performance, current feedback amplifier. Using ADI's proprietary eXtra Fast Complementary Bipolar (XFCB) process, the amplifier can achieve a small signal bandwidth of 1.5 GHz and a slew rate of 4100 V/ μ s.

Features

- High speed
 - 1.5 GHz, -3 dB bandwidth ($G = +1$)
 - 650 MHz, full power bandwidth ($G = +2, V_o = 2$ V p-p)
 - Slew rate: 4100 V/ μ s
 - 0.1% settling time: 12 ns
 - 0.1 dB flatness: 170 MHz
- Low noise: 1.6 nV/ $\sqrt{\text{Hz}}$ input voltage noise
- Low distortion over wide bandwidth
 - 75 dBc SFDR @ 20 MHz
 - 62 dBc SFDR @ 50 MHz
- Input offset voltage: 1 mV typ
- High output current: 100 mA
- Wide supply voltage range: 4.5 V to 12 V
- Supply current: 13.5 mA

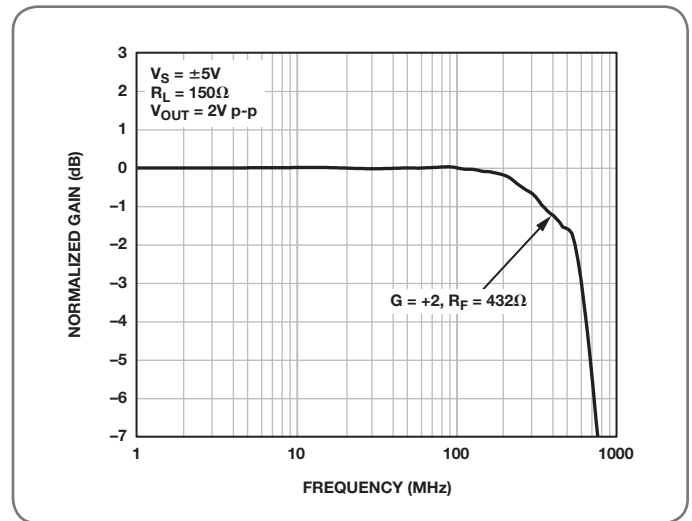

Large signal frequency response.

Applications

- Professional video
- High speed instrumentation
- Video switching
- IF/RF gain stage
- CCD imaging

Current Feedback Amplifiers

Part Number	No. of Amps	Disable	Supply Voltage (V)	Rail-to-Rail ¹	A _{CL} MIN	BW @ A _{CL} MIN (MHz)	Slew Rate (V/ μ s)	Distortion SFDR ¹ @ BW (dBc) (MHz)	Noise (nV/ $\sqrt{\text{Hz}}$)	Noise ³ (pA/ $\sqrt{\text{Hz}}$)	V _{OS} Max (mV)	I _b (μ A Max)	I _q /Amp (mA Typ)	I _{OUT} (mA)	Temperature Range ²	Packaging	Price @ 1k (DEM \$US)
<i>Value</i>																	
ADA4860-1	1	•	5, \pm 5		1	800	790	-75 10	4	1.5/7.7	13	10	6	85	I	SOT-23	0.56
ADA4861-3	3	•	5, \pm 5		1	730	680	-68 10	3.8	1.7/5.5	13	13	6	100	I	SOIC	0.96
ADA4862-3	3	•	5, \pm 5		2	500	1050	-68 10	10.6 (RTO)	1.4	25 (RTO)	1	5.5	75	I	SOIC	0.96
AD8014	1		5, \pm 5		1	480	4000	-70 5	3.5	5	5	15	1.1	50	I	SOT-23/SOIC	1.20
AD8072	2		5, \pm 5		1	100	500	-64 5	3	6	6	12	3.5	30	I	SOIC/MSOP	1.67
AD8073	3		5, \pm 5		1	100	500	-64 5	3	6	6	12	3.5	30	I	SOIC/MSOP	2.18
<i>High Performance</i>																	
ADA4870	1	•	\pm 5, \pm 40		1	70	2500	-70 1	2.1	4.2/47	15	25	32.5	1000	I	PSOP-3	8.50
AD8000	1	•	5, \pm 5		1	1500	4100	-75 20	1.6	3.4/26	10	45	13.5	100	H5	SOIC/LFCSP	1.70
AD8003	3	•	5, \pm 5		1	1500	4100	-75 20	1.6	3.4/26	10	45	13.5	100	H5	SOIC/LFCSP	2.92
AD8009	1		5, \pm 5		1	1000	5500	-38 20	1.9	46/41	5	150	14	175	I	SOT-23/SOIC	1.75
AD8001	1		\pm 5		1	880	1000	-66 5	2	2/18	5.5	25	5	70	I	SOT-23/SOIC	1.49
AD8002	2		\pm 5		1	880	1000	-66 5	2	2/18	5.5	25	5	70	I	SOT-23/SOIC	2.86
AD8007	1		5, \pm 5		1	650	1000	-83 20	2.7	2/23	4	8	9	30	I	SC70/SOT-23/SOIC/MSOP	1.33
AD8008	2		5, \pm 5		1	650	1000	-83 20	2.7	2/23	4	8	9	30	I	SC70/SOT-23/SOIC/MSOP	2.22
AD8011	1		5, \pm 5		1	400	3500	-75 5	2	5	5	15	1	30	I	SOIC	2.30
AD8023	3	•	5, \pm 5		1	400	1200	-78 5	2	14	5	45	6.2	70	I	SOIC	5.20
AD8005	1		5, \pm 5		1	270	1500	-53 5	4	1.1/9.1	30	10	0.4	10	I	SOT-23	1.64
AD8004	4		5, \pm 5		1	250	3000	-78 5	1.5	38	3.5	90	3.5	50	I	SOIC	4.40
ADA4310-1	2	•	5, \pm 5		2	190	820	-95 1	2.9	22	1	6	7.6	250	I	LFCSP/MSOP	1.05
AD8017	2		5, \pm 5		1	160	1600	-78 0.5	1.9	23/21	3	67	7	270	I	SOIC	2.25
AD8013	3	•	5, \pm 5		1	140	1000	-76 5	3.5	12	5	15	4	30	I	SOIC	4.88
<i>With Charge Pump</i>																	
ADA4858-3	3	•	3, 5		1	600	600	-71 5	4	2/9	14	13	19	21	H	LFCSP	1.69
ADA4859-3	3	•	3, 5		2	195	740	-70 5	17 (RTO)	2	25 (RTO)	2	17	19	H	LFCSP	1.69

¹ RRIO: rail-to-rail input/output, RRO: rail-to-rail output, SS: single supply (IVR includes $-V_{SV}$).

² Temperature range: H = extended industrial (-40°C to $+125^\circ\text{C}$), I = industrial (-40°C to $+85^\circ\text{C}$).

³ Noise first entry is noninverting input, second entry is inverting input.

High Speed Amplifiers (BW > 50 MHz)

High Output Current Amplifiers

ADA4870: High Speed, High Voltage, 1 A Output Drive Amplifier

The ADA4870 is a unity-gain stable, high speed current feedback amplifier capable of delivering 1 A of continuous output current. Manufactured on ADI's proprietary high voltage XFCB process, the innovative architecture of the AD4870 enables high performance signal processing solutions in a variety of demanding applications.

Features

- Ideal for driving high capacitive or low resistive loads
- Wide supply range: 10 V to 40 V
- High output current drive: 1 A
- Wide output voltage swing: 37 V swing with 40 V supply
- Large signal -3 dB BW: 45 MHz ($V_{OUT} = 20$ Vp-p, 300 pF load)
- High slew rate: 2500 V/ μ s (peak)
- Low noise: 2.1 nV/ $\sqrt{\text{Hz}}$
- Supply current: 32.5 mA
 - Power down (800 μ A)
- Short-circuit protection
 - Current limit: 1.2 A
- Thermal protection

Applications

- Envelope tracking
- Composite amplifier
- Power FET driver
- Ultrasound
- Piezo driver
- Waveform generation
- ATE
- CCD panel driver
- PIN diode drive

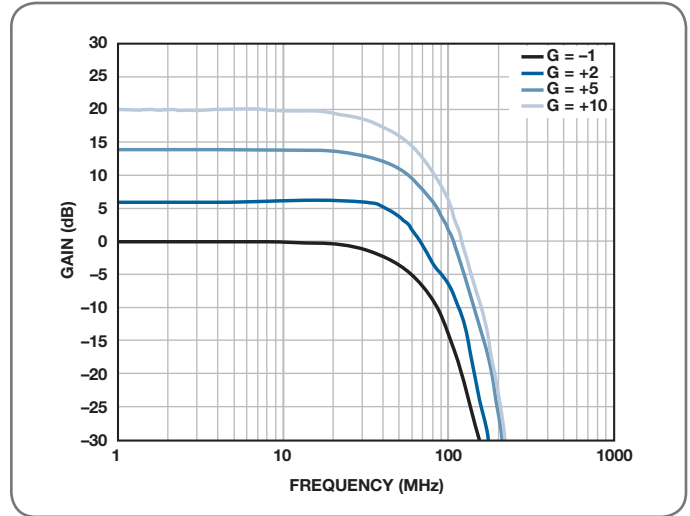

Slew Rate, $V_S = \pm 20$ V, $V_{OUT} = 30$ V p-p $AV = +2$, $R_F = 1.5$ k Ω , $C_L = 300$ pF, $R_S = 5\Omega$

High Output Current Amplifiers

Part Number	No. of Amps	Disable	Supply Voltage (V)	Rail-to-Rail ¹	A _{CL} Min	BW @ A _{CL} Min (MHz)	Slew Rate (V/ μ s)	Distortion SFDR ³ @ BW		Noise (nV/ $\sqrt{\text{Hz}}$)	V _{OS} Max (mV)	I _B (μ A Max)	I _S /Amp (mA Typ)	I _{OUT} (mA)	Temperature Range ²	Packaging	Price @ 1k (OEM \$US)
								(dBc)	(MHz)								
ADA4870	1	•	$\pm 5, \pm 20$		1	70	2500	-70	1	2.1	15	25	32.5	1000	I	PSOP	8.50
AD8397	2		3, 5, $\pm 5, \pm 12$	RRO	1	69	53	-87	0.1	4.5	1	2	5.5	310	I	SOIC	2.32
AD8390A	1	•	$\pm 5, \pm 12$		5	60	300	-82 ³	1	8	3	7	3.8	400	I	LFCSP	1.08
AD8392A	4	•	$\pm 5, \pm 12$		1	40	900	-72 ³	1	4.3	5	15	3.6	400	I	LFCSP/ TSSOP	1.83
ADA4310	2	•	5, ± 6		2	190	820	-95	1	2.9	1	6	7.6	250	I	LFCSP/ MSOP	1.43
AD8017	2		5, ± 5		1	160	1600	-78	0.5	1.9	3	67	7	270	I	SOIC	2.36

¹ RRIO: rail-to-rail input/output, RRO: rail-to-rail output, SS: single supply (IVR includes $-V_{SV}$).

² Temperature range: H = extended industrial (-40°C to $+125^\circ\text{C}$), I = industrial (-40°C to $+85^\circ\text{C}$).

³ THD: total harmonic distortion.

High Speed Amplifiers (BW > 50 MHz)

High Supply Voltage (≥ 12 V)

ADA4898-1/ADA4898-2: High Voltage, Low Noise, Low Distortion, Unity-Gain Stable Op Amps

The ADA4898-1 (single) and ADA4898-2 (dual) are voltage feedback op amps featuring a linear, low noise input stage and internal compensation that achieves high slew rates and low noise. They are ideal for use in 16- and 18-bit systems with power supplies from ± 5 V to ± 16 V. With the wide supply voltage range, low offset voltage, and wide bandwidth, the ADA4898-1 and ADA4898-2 are extremely versatile.

Features

- Ultralow noise
 - $0.9 \text{ nV}/\sqrt{\text{Hz}}$
 - $2.4 \text{ pA}/\sqrt{\text{Hz}}$
 - $1.2 \text{ nV}/\sqrt{\text{Hz}}$ at 10 Hz
- Ultralow distortion: -93 dBc at 500 kHz
- Wide supply voltage range: ± 5 V to ± 16 V
- High speed
 - -3 dB bandwidth: 65 MHz ($G = +1$)
 - Slew rate: $55 \text{ V}/\mu\text{s}$
- Unity-gain stable
- Low input offset voltage: $160 \mu\text{V}$ max

Applications

- Instrumentation
- Active filters
- DAC buffers
- SAR ADC drivers
- Optoelectronics

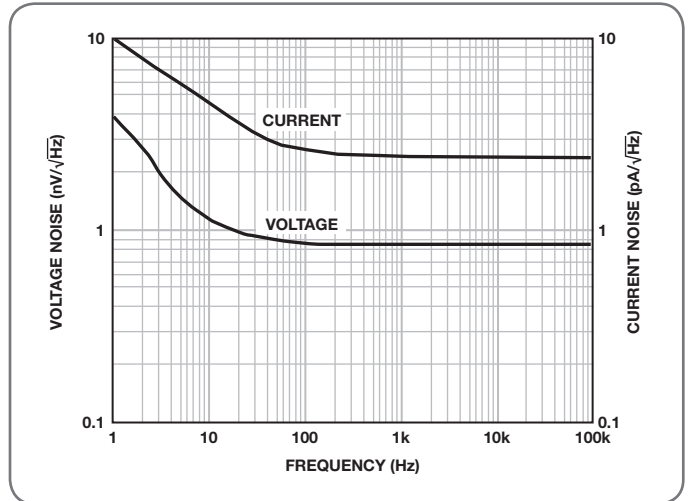

Input voltage noise and current noise frequency.

High Supply Voltage Amplifiers

Part Number	No. of Amps	Disable	Supply Voltage (V)	Rail-to-Rail ¹	A _{CL} Min	BW @ A _{CL} Min (MHz)	Slew Rate (V/ μ s)	Distortion SFDR ¹ @ BW		Noise (nV/ $\sqrt{\text{Hz}}$)	V _{OS} Max (mV)	I _B (μ A Max)	I _B /Amp (mA Typ)	I _{OUT} (mA)	Temperature Range ²	Packaging	Price @ 1k (OEM \$US)
								(dBc)	(MHz)								
ADA4870	1	•	$\pm 5, \pm 40$		1	70	2500	-70	1	2.1	15	25	32.2	1000	I	PSOP-3	8.50
ADA4898-1	1		$\pm 5, \pm 12, \pm 15$		1	65	55	-116	0.1	0.9	0.12	0.4	8.1	40	H	SOIC	2.29
ADA4898-2	2		$\pm 5, \pm 12, \pm 15$		1	65	55	-116	0.1	0.9	0.12	0.4	8.1	40	H	SOIC	3.21
AD829	1		$\pm 5, \pm 12, \pm 15$		1	120	150	-55 ³	1	1.7	1	7	5	32	H	SOIC	2.78
AD818	1		$5, \pm 5, \pm 12, \pm 15$		2	130	450	-78 ³	1	10	2	6.6	7	50	I	SOIC	1.96
AD828	2		$5, \pm 5, \pm 12, \pm 15$		2	130	450	-78 ³	1	10	2	6.6	7	50	I	SOIC	2.43
AD844	1		$\pm 5, \pm 12, \pm 18$		2	60	2000	-86 ³	0.1	2	0.3	0.45	6.5	50	H	SOIC	2.81
AD847	1		$\pm 5, \pm 12, \pm 15$		1	50	300	-92 ³	0.1	15	2	7	4.8	32	H/I	SOIC	2.89
AD827	2		$\pm 5, \pm 12, \pm 15$		1	50	300	-92 ³	0.1	15	2	7	4.8	32	H/I	SOIC	5.89
AD817	1		$5, \pm 5, \pm 12, \pm 15$		1	50	350	-78 ³	1	15	2	6.6	7	50	I	SOIC	1.76
AD826	2		$5, \pm 5, \pm 12, \pm 15$		1	50	350	-78 ³	1	15	2	6.6	7	50	I	SOIC	2.43

¹ RRIO: rail-to-rail input/output, RRO: rail-to-rail output, SS: single supply (IVR includes $-V_{SY}$).

² Temperature range: H = extended industrial (-40°C to $+125^\circ\text{C}$), I = industrial (-40°C to $+85^\circ\text{C}$).

³ THD: total harmonic distortion.

High Speed Amplifiers (BW > 50 MHz)

Clamping Amplifiers

AD8036/AD8037: Low Distortion, Wide Bandwidth, Voltage Feedback Clamp Amps

The AD8036 and AD8037 clamping amplifiers allow the designer to specify a high (V_{CH}) and low (V_{CL}) output clamp voltage. The output signal will clamp at these specified levels. The AD8036 is unity gain stable. The AD8037 is stable at a gain of ≥ 2 . Using a unique patent pending CLAMPIN™ input clamp architecture, these amplifiers offer a 10× improvement in clamp performance compared to traditional output clamping devices. Utilizing voltage feedback architecture, they meet the requirements of many applications that previously depended on current feedback amplifiers.

Features

- Super clamping characteristics
 - 3 mV clamp error
 - 1.5 ns overdrive recovery
 - Minimized nonlinear clamping region
 - 240 MHz clamp input bandwidth
 - ± 3.9 V clamp input range
- Wide bandwidth
 - Small signal—240 MHz (AD8036) and 270 MHz (AD8037)
 - Large signal (4 V p-p) – 195 MHz (AD8036) and 190 MHz (AD8037)
- Good dc characteristics
 - 2 mV offset
 - 10 $\mu\text{V}/^\circ\text{C}$ drift
- Ultralow distortion, low noise
 - -72 dBc typ @ 20 MHz
 - 4.5 nV/ $\sqrt{\text{Hz}}$ input voltage noise
- High speed
 - Slew rate 1500 V/ μs
 - Settling 10 ns to 0.1%, 16 ns to 0.01%
- ± 3 V to ± 5 V supply operations

Applications

- ADC buffer
- IF/RF signal processing
- High quality imaging
- Broadcast video systems
- Video amplifier
- Full wave rectifier

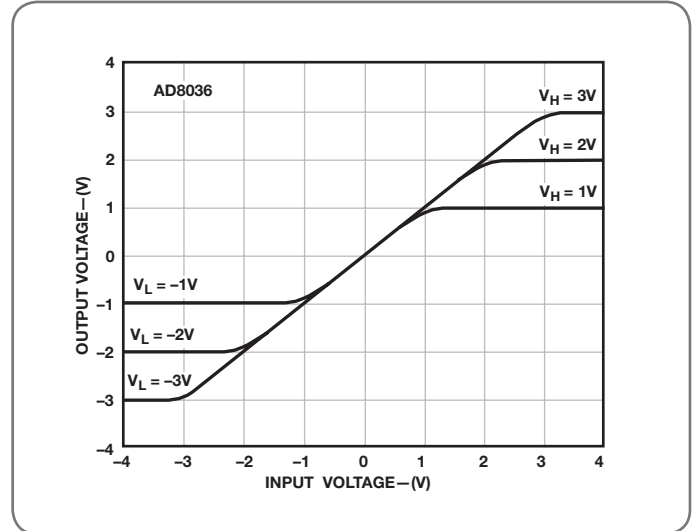

Clamp dc accuracy vs. input voltage.

Clamp Amplifiers

Part Number	No. of Amps	Disable	Supply Voltage (V)	Rail-to-Rail ¹	A_{CL} Min	BW @ A_{CL} Min (MHz)	Slew Rate (V/ μs)	Distortion SFDR ³ @ BW		Noise (nV/ $\sqrt{\text{Hz}}$)	V_{OS} Max (mV)	I_b (μA Max)	I_o /Amp (mA Typ)	I_{OUT} (mA)	Temperature Range ²	Packaging	Price @ 1k (OEM \$US)
								(dBc)	(MHz)								
AD8037	1		65		2	270	1500	-773	10	4.5	7	9	18.5	70	I	SOIC	4.33
AD8036	1		65		1	240	1200	-8 ³	10	6.7	7	10	20.5	70	H/I	SOIC	4.17

¹ RRIO: rail-to-rail input/output, RRO: rail-to-rail output, SS: single supply (IVR includes $-V_S$).

² Temperature range: H = extended industrial (-40°C to $+125^\circ\text{C}$), I = industrial (-40°C to $+85^\circ\text{C}$).

³ THD: total harmonic distortion.

Amplifier and Standard Linear Selection Guide

Instrumentation Amplifiers

AD8422: High Performance, Low Power, Rail-to-Rail Precision Instrumentation Amplifier

The AD8422 is a high precision, low power, low noise, rail-to-rail instrumentation amplifier that delivers the best performance per unit μA in the industry. The AD8422 process signals with ultralow distortion performance that is load independent over its full output range. The AD8422 is the latest generation development of the industry-standard AD620. Employing new process technologies and design techniques, the AD8422 achieves higher dynamic range and lower errors than its predecessors, while consuming less than one-third of the power.

Features

- Low power: 330 μA maximum quiescent current
- Rail-to-rail output
- Low noise and distortion
 - 8 $\text{nV}/\sqrt{\text{Hz}}$ maximum input voltage noise at 1 kHz
 - 0.15 μV p-p RTI noise ($G = 100$)
 - 0.5 ppm nonlinearity with 2 $\text{k}\Omega$ load ($G = 1$)
- Excellent ac specifications
 - 80 dB minimum CMRR at 7 kHz ($G = 1$)
 - 2.2 MHz bandwidth ($G = 1$)
- High precision dc performance (AD8422BRZ)
 - 150 dB minimum CMRR ($G = 1000$)
 - 0.04% maximum gain error ($G = 1000$)
 - 0.3 $\mu\text{V}/^\circ\text{C}$ maximum input offset drift
 - 0.5 nA maximum input bias current
- Wide supply range
 - 3.6 V to 36 V single supply
 - ± 1.8 to ± 18 V dual supply
- Input overvoltage protection: 40 V from opposite supply
- Gain range: 1 to 1000

Applications

- Medical instrumentation
- Industrial process controls
- Strain gages
- Transducer interface
- Precision data acquisition systems
- Channel isolated systems
- Portable instrumentation

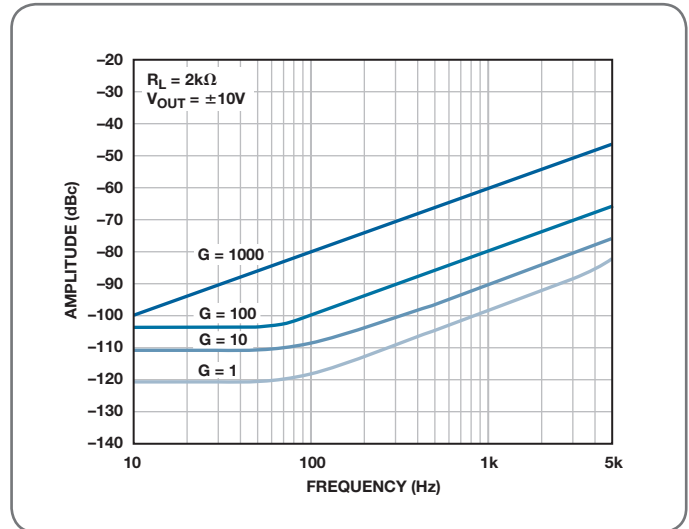

Total harmonic distortion vs. frequency

Instrumentation Amplifiers (continued)

AD8421: 3 nV/√Hz, Low Power Instrumentation Amplifier with High Slew Rate and Fast Settling Time

The AD8421 delivers excellent precision performance with additional benefit of speed. The low cost, low power, extremely low noise, ultralow bias current instrumentation amplifier is ideal for a broad spectrum of signal conditioning and data acquisition applications. The device features extremely high CMRR and excellent noise performance, allowing it to extract low level signals in the presence of high frequency common-mode noise over a wide temperature range. With slew rate of 35 V/μs, and 0.7 μs settling time to 0.01% (G = 1) at 10 MHz bandwidth, the AD8421 amplifies high speed signals and excels in applications that require high channel-count multiplexed systems.

Features

- Low power: 2.3 mA maximum supply current
- Low noise
 - 3.2 nV/√Hz maximum input voltage noise at 1 kHz
 - 200 fA/√Hz current noise at 1 kHz
- Excellent ac specifications
 - 10 MHz bandwidth (G = 1)
 - 2 MHz bandwidth (G = 100)
 - 0.6 μs settling time to 0.001% (G = 10)
 - 80 dB CMRR at 20 kHz (G = 1)
 - 35 V/μs slew rate
- High precision dc performance (AD8421BRZ)
 - 94 dB CMRR minimum (G = 1)
 - 0.2 μV/°C maximum input offset voltage drift
 - 1 ppm/°C maximum gain drift (G = 1)
 - 500 pA maximum input bias current
- Input protected to 40 V from opposite supply
- ±2.5 V to ±18 V dual supply (5 V to 36 V single supply)
- Gain set with a single resistor (G = 1 to 10,000)

Applications

- Multiplexed input applications
- Vibration analysis
- Microphone preamplification
- ADC driver
- Medical instrumentation
- Precision data acquisition

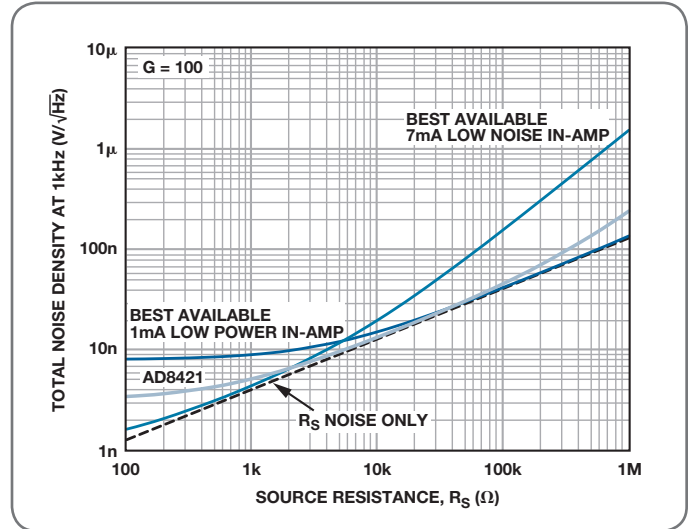

Noise density vs. source resistance.

Instrumentation Amplifiers

Part Number	Package			Rail-to-Rail Output	Supply Current Max (mA)	Operating Voltage Range (V)	CMRR @ 60 Hz G = 1 Min (dB)	Input Offset Voltage TC Max (μV/°C)	Input Offset Voltage (RTI) Max (μV)	Input Bias Current Max (nA)	Input Voltage Noise Density (f = 1 kHz) Max (nV/√Hz)	Settling Time to 0.01% G = 1 Typ (μs)	BW @ G = 1 Typ (kHz)	Gain Range Min to Max (V/V)	Gain Error @ G = 1 Max (%)	Price @ 1k (OEM \$US)
	SOIC	MSOP	DIP													
AD620	•		•		1.3	±2.3 to ±18	73	1	125	2	13	15	1000	1 to 10,000	0.1	3.38
AD621	•		•		1.3	±2.3 to ±18	93 (G = 10)	2.5 (total RTI)	250 (total RTI)	2	17 (total RTI)	12 (G = 10, 100)	800 (G = 10)	10, 100	0.15 (G = 10, 100)	4.34
AD622	•		•		1.3	±2.6 to ±18	66	1	125	5	12 (typ)	10 (to 0.1%)	1000	1 to 1000	0.15	2.56
AD623	•	•	•	•	0.55, 0.48	±2.5 to ±6, 2.7 to 12	70	2	200	25	35 (typ)	30	800	1 to 1000	0.1	1.43
AD627	•		•	•	0.085	±1.1 to ±18, 2.2 to 36	77 (G = 5)	3	200, 250	10	38 (typ)	135 (G = 5), 65 (G = 5)	80 (G = 5)	5 to 1000	0.1 (G = 5)	2.61
AD8220		•		•	0.8	±2.25 to ±18, 4.5 to 36	78	10	250, 300	0.025	17	5, 2.5	1500	1 to 1000	0.06	2.32

Instrumentation Amplifiers (continued)

Part Number	Package			Rail-to-Rail Output	Supply Current Max (mA)	Operating Voltage Range (V)	CMRR @ 60 Hz G = 1 Min (dB)	Input Offset Voltage TC Max ($\mu\text{V}/^\circ\text{C}$)	Input Offset Voltage (RTI) Max (μV)	Input Bias Current Max (nA)	Input Voltage Noise Density (f = 1 kHz) Max (nV/ $\sqrt{\text{Hz}}$)	Settling Time to 0.01% G = 1 Typ (μs)	BW @ G = 1 Typ (kHz)	Gain Range Min to Max (V/V)	Gain Error @ G = 1 Max (%)	Price @ 1k (OEM \$US)	
	SOIC	MSOP	DIP														
AD8221A	•	•			1	± 2.3 to ± 18	80	0.9	70	2	8	10	825	1 to 1000	0.1	2.01	
AD8221B	•				1	± 2.3 to ± 18	90	0.3	25	0.4	8	10	825	1 to 1000	0.02	3.9	
AD8222		16-lead LFCSP			2.2	± 2.3 to ± 18	80	0.4	60	2	8	10	1200	1 to 10,000	0.05	3.63	
AD8223	•	•		•	0.5	± 2.5 to ± 12.5 , 2.7 to 25	82 (G = 5)	4	250	25	35	90 (G = 5)	180 (G = 5)	5 to 1000	0.1	1.05	
AD8224		16-lead LFCSP			•	1.6	± 2.25 to ± 18 , 4.5 to 36	78	10	300	0.025	17	5, 2.5	1500	1 to 1000	0.06	4.17
AD8226	•	•		•	0.425	± 1.35 to ± 18 , 2.2 to 36	86	2	100	27	24	25	1500	1 to 1000	0.015	1.05	
AD8227	•	•		•	0.425	± 1.5 to ± 18 , 2.2 to 36	90 (G = 5)	2	200	27	25	14 (G = 5)	250 (G = 5)	5 to 1000	0.04 (G = 5)	1.04	
AD8228	•	•			1	± 2.3 to ± 18	94 (G = 10)	0.9	90	1.5	8	6 (G = 10)	650 (G = 10)	10, 100	0.07 (G = 10)	3.03	
AD8229	•		•		7	± 4 to ± 17	86	1	100	70	1.1	0.75	15,000	1 to 1000	0.03	150	
AD8295		16-lead LFCSP			2.3	± 2.3 to ± 18	80	0.4	120	2	8	10	1200	1 to 1000	0.05	2.03	
AD8230	•			•	3.5	± 4 to ± 8 , 8 to 16	110 (G = 10)	0.05	10	1	240	—	2 (G = 10)	10 to 1000	0.01	2.99	
AD8231		16-lead LFCSP			•	4.5	± 1.5 to ± 3 , 3 to 6	80	0.05	15	0.5	32	4	2700	1, 2, 4, 8, 16, 32, 64, 128	0.05	1.71
AD8235		11-lead WLCSP			•	0.04	1.8 to 5.5	90 (G = 5)	0.7 (typ)	2.5	0.05	76	444 (G = 5)	23 (G = 5)	5 to 200	0.05 (G = 5)	0.99
AD8236		•		•	0.04	1.8 to 5.5	86 (G = 5)	2.5 (typ)	3.5	0.01	76	444 (G = 5)	23 (G = 5)	5 to 200	0.05 (G = 5)	0.99	
AD8237		•		•	0.13	1.8 to 5.5	106	0.3	75	0.65	68 (typ)	80	200	1 to 1000	0.005	0.93	
AD8250		•			4.5	± 5 to ± 17	80	1.2	200	30	18	0.585	10,000	1, 2, 5, 10	0.03	5.01	
AD8251		•			4.5	± 5 to ± 17	80	1.2	200	30	18	0.615	10,000	1, 2, 4, 8	0.03	5.01	
AD8253		•			5.3	± 5 to ± 17	80	1.2	150	50	10	0.78	10,000	1, 10, 100, 1000	0.03	4.95	
AD8420		•		•	0.08	± 2.7 to ± 18 , 2.7 to 36	100	1	125	27	55 (typ)	3	250	1 to 1000	0.02	0.89	
AD8421A	•	•			2.3	± 2.5 to ± 18	86	0.4	60	2	3.2	0.7	10,000	1 to 10,000	0.02	2.35	
AD8421B	•	•			2.3	± 2.5 to ± 18	94	0.2	25	0.5	3.2	0.7	10,000	1 to 10,000	0.01	4.32	
AD8422A	•	•		•	0.33	± 1.8 to ± 15	86	0.4	60	1	8	13	2200	1 to 1000	0.03	2.1	
AD8422B	•	•		•	0.33	± 1.8 to ± 15	94	0.3	25	0.5	8	13	2200	1 to 1000	0.01	3.49	
AD8426		16-lead LFCSP			•	0.8	± 1.35 to ± 18 , 2.2 to 36	80	2	200	27	27	1000	1 to 1000	0.04	2.2	
AD8428	•				6.8	± 4 to ± 18	130 (G = 2000)	1	100	200	1.5	0.75 (G = 2000)	3500 (G = 2000)	2000	0.2	6.6	
AD8429	•				7	± 4 to ± 18	80	1	150	300	1	0.75	15,000	1 to 10,000	0.05	3.50	
AD8553		•		•	1.2	1.8 to 5.5	100 (G = 10)	0.1	20	1	30	—	1	0.1 to 10,000	0.05 (G = 100)	1.32	

Amplifier and Standard Linear Selection Guide

Current Sense Amplifiers

AD8418A: Bidirectional, Zero-Drift, Current Sense Amplifier

The AD8418A is a high voltage, high resolution, bidirectional, zero-drift current sense amplifier. It features an initial gain of 20 V/V, with a maximum $\pm 0.15\%$ gain error over the entire temperature range. Featuring zero-drift architecture, the device achieves a typical offset drift of $0.1 \mu\text{V}/^\circ\text{C}$ throughout the operating temp range and the common-mode voltage range. The buffered output voltage directly interfaces with any typical converter. The device performs bidirectional current measurements across a shunt resistor in a variety of automotive and industrial applications, including motor control, solenoid control and battery management. Its ability to reject PWM input common-mode voltages along with the zero-drift architecture and built-in EMI filters allow the AD8418A to deliver breakthrough performance for these demanding applications.

Features

- Typical $0.1 \mu\text{V}/^\circ\text{C}$ offset drift
- Max $\pm 400 \mu\text{V}$ voltage offset over full temperature range
- 2.7 V to 5.5 V operating range
- Electromagnetic interference (EMI) filters included
- High common-mode input voltage range
 - $-2 \text{ V to } +70 \text{ V}$ operating
 - $-4 \text{ V to } +85 \text{ V}$ survival
- Initial gain = 20 V/V
- Wide operating range of -40°C to $+125^\circ\text{C}$
- Bidirectional operation
- Available in 8-lead SOIC and MSOP
- Qualified for automotive applications

Applications

- High-side current sensing in
 - Motor controls
 - Solenoid controls
 - Power management
- Low-side current sensing
- Diagnostic protection

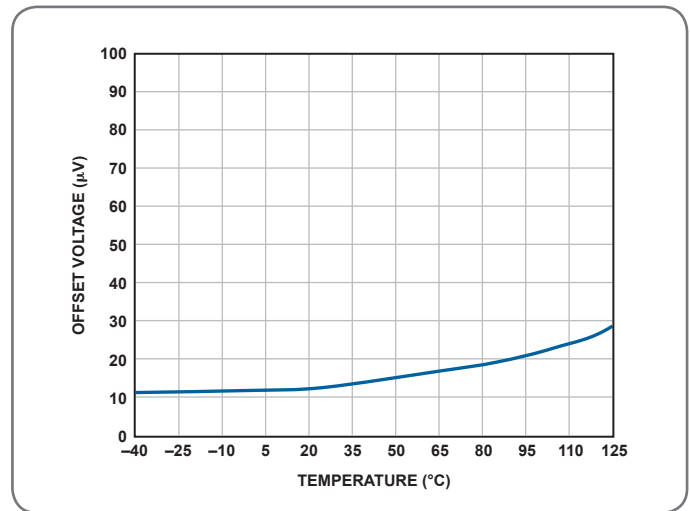

Typical offset drift vs. temperature

Current Sense Amplifiers

Part Number	Package			Common-Mode Voltage Range (V)	Bandwidth @ G = 10 Typ (kHz)	Input Offset Voltage TC Max ($\mu\text{V}/^\circ\text{C}$)	Input Offset Voltage (RTI) Max (μV)	Gain Drift Max (ppm/ $^\circ\text{C}$)	CMRR DC to 1 kHz Min (dB)	Operating Supply Voltage Range (V)	Temperature Range ($^\circ\text{C}$)	Supply Current Max (mA)	Input Voltage Noise Density (f = 1 kHz) Typ (nV/ $\sqrt{\text{Hz}}$)	Gain Range Min to Max (V/V)	Gain Error Max (%)	Price @ 1k (OEM \$US)
	SOIC	MSOP	DIP													
AD8202	•	•		-8 to +28	50	± 10	± 1000	20	82	3.5 to 12	-40 to +125	1	275	20	± 0.3	1.51
AD8203	•	•		-6 to +30	60	± 10	± 1000	20	82	3.5 to 12	-40 to +125	1	300	14	± 0.3	1.37
AD8205/ AD8206		•		-2 to +65	50/100	± 15 (typ)	± 2000	30 (typ)	78	4.5 to 5.5	-40 to +150	2	500	50/20	± 1	1.51/1.37
AD8207	•			-4 to +65	150	± 1	± 400	15	80	3.3 to 5.5	-40 to +125	2.5	500	20	± 0.3	2.29
AD8208/ AD8209	•	•		-2 to +45	20/14	± 20	± 2000	-20	80	4.5 to 5.5	-40 to +125	2	500	20/14	± 0.3	1.67
AD8210	•			-2 to +65	450	± 8	± 1000	20	100	4.5 to 5.5	-40 to +125	2	70	20	± 0.5	1.81
AD8211			5-lead SOT-23	-2 to +65	500	± 12 (typ)	± 1000	-20 (typ)	95	4.5 to 5.5	-40 to +125	2	70	20	± 0.5	0.81
AD8212		•		7 to 65	1000	± 10	± 2000	30	100	7 to 65	-40 to +125	0.75	40	Adjustable	± 1	1.32
AD8213		•		-2 to +65	500	± 12	± 1000	25	95	4.5 to 5.5	-40 to +125	3.75	70	20	± 0.5	2.01
AD8214		•		5 to 65	—	± 15 (typ)	± 3000	—	100	5 to 65	-40 to +125	1.2 (typ)	70	Adjustable	—	0.76
AD8215	•			-2 to +65	450	-15 to +18	± 1000	-15	95	4.5 to 5.5	-40 to +125	2.2	70	20	± 0.15	1.21
AD8216		•		-4 to +65	3000	± 20	± 3000	15	80	4.5 to 5.5	-40 to +125	2	100	3	± 0.4	1.62
AD8217		•		4 to 80	500	± 0.1 (typ)	± 300	± 5 (typ)	90	4 to 80	-40 to +125	0.8	100	20	± 0.35	0.99
AD8218		•		4 to 80	450	± 0.5	± 300	10	90	4 to 80	-40 to +125	0.8	100	20	± 0.3	1.05
AD8219		•		4 to 80	500	± 0.5	± 300	10	90	4 to 80	-40 to +125	0.8	100	60	± 0.3	0.95
AD8417	•	•		-2 to +70	250	± 0.5	± 300	10	90	2.7 to 5.5	-40 to +150	2.7	110	60	± 0.3	0.99
AD8418	•	•		-2 to +70	250	± 0.5	± 300	10	90	2.7 to 5.5	-40 to +125	2.7	110	20	± 0.3	0.89
AD8418A	•	•		-2 to +70	250	± 0.5	± 300	10	90	2.7 to 5.5	-40 to +150	2.7	110	20	± 0.3	0.99

Amplifier and Standard Linear Selection Guide

Difference Amplifiers

AD8479: ± 600 V Common-Mode Voltage Precision Difference Amplifier

The AD8479 is a difference amplifier with a very high input common-mode voltage range. The precision device allows users to accurately measure differential signals in the presence of high common-mode voltages up to ± 600 V. It can replace costly isolation amplifiers in applications that do not require galvanic isolation. The AD8479 operates over a ± 600 V common-mode voltage range and has inputs that are protected from common-mode or differential mode transients up to ± 600 V. It is available in 8-lead SOIC package. The AD8479 is the upgrade version of the industrial standard AD629.

Features

- ± 600 V common-mode voltage range
- Rail-to-rail output
- Fixed gain of 1
- Wide power supply range of ± 2.5 V to ± 18 V
- 550 μ A typical power supply current
- Excellent ac specifications
 - 90 dB minimum CMRR
 - 130 kHz bandwidth
- High accuracy dc performance
 - 5 ppm maximum gain nonlinearity
 - 10 μ A/ $^{\circ}$ C maximum offset voltage drift
 - 5 ppm/ $^{\circ}$ C maximum gain drift

Applications

- High voltage current sensing
- Battery cell voltage monitors
- Power supply current monitors
- Motor controls
- Isolation

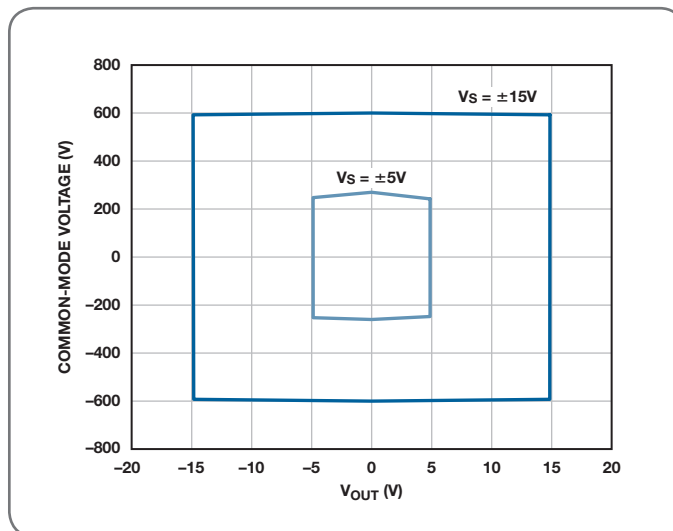

Input common-mode voltage vs. output voltage

Difference Amplifiers

Part Number	Package			Common-Mode Voltage Range (V)	Bandwidth Typ (kHz) ¹	System Input Offset Voltage TC Max (μ / $^{\circ}$ C)	System Input Offset Voltage (RTI) Max (μ V)	Gain Drift Max (ppm/ $^{\circ}$ C)	CMRR DC to 1 kHz Min (dB)	Operating Supply Voltage Range (V)	Temperature Range ($^{\circ}$ C)	Supply Current per Channel Max (mA)	Input Voltage Noise Density Typ (nV/ \sqrt Hz) (f = 1 kHz)	Gain Range Min to Max (V/V)	Gain Error Max (%)	Price @ 1k (OEM \$U.S.) ²
	SOIC	MSOP	DIP													
AD628	•	•		± 120	600	8	1500	5	75	± 2.25 to ± 18 , +4.5 to +36	-40 to +85	1.6	300	0.1 to 100	0.1	1.82
AD629	•		•	± 270	500	10	500	10	86	± 2.5 to ± 18	-40 to +85	1	550	1	0.03	2.9
AD8270		16-lead LFCSP		-VS -0.4 to +VS +0.4	15,000	2 (typ)	1000	10	76	± 2.5 to ± 18	-40 to +85	2.5	38	0.5, 1, 2	0.08	1.91
AD8271		•		-VS -0.4 to +VS +0.4	15,000	2 (typ)	1000	2	80	± 2.5 to ± 18	-40 to +85	2.6	38	0.5, 1, 2	0.02	1.25
AD8273/ AD8274	•	•		3 (-VS +1.5) to 3 (+VS -1.5)	20,000	3 (typ)	700	2-Oct	77	± 2.5 to ± 18	-40 to +85	2.5	26	0.5, 2	0.05/0.03	1.60/1.05
AD8276/ AD8277	•	•		-2 (VS +0.1) to +2 (VS -1.5)	550	2	200	1	86	± 2 to ± 18 , 2 to 36	-40 to +125	0.2	65	1	0.02	0.95/1.60
AD8278/ AD8279	•	•		-3 (VS +0.1) to +3 (VS -1.5)	1000	1	100	1	80	± 2 to ± 18 , 2 to 36	-40 to +125	0.2/0.175	47	0.5, 2	0.02	0.95/1.60
AD8275		•		-12.3 to +12	15,000	7	500	1	86	3.3 to 15	-40 to +85	2.3	40	0.2	0.024	1.6
AD8475		•		-12.5 to +12.5	150,000	2.5 (typ)	500	3	86	3 to 10	-40 to +125	3.2	10	0.4	0.02	1.99
AD8476		•		-2 (VS +0.05) to +2 (VS -0.05)	6000	4	200	1	90	± 1.5 to ± 9 , 3 to 18	-40 to +125	0.33	39	1	0.02	1.99
AMP03	•		•	± 20	3000	—	400	—	80	± 5 to ± 18	-55 to +125	3.5	—	1	0.008	3.10
AD8479A		•		± 600	130	15	3	10	80	± 2.5 to ± 18	-40 to +125	0.65	1600	1	0.02	2.81
AD8479B	•			± 600	130	10	1	5	90	± 2.5 to ± 18	-40 to +125	0.65	1600	1	0.01	4.33

¹ For fixed gain difference amplifier, the bandwidth is specified at this gain. If not fixed gain, then bandwidth at the minimal gain is used.

² USD 1000s, recommended resale, FOB U.S.A.

Amplifier and Standard Linear Selection Guide

Variable Gain Amplifiers (VGA)

AD8338: Low Power, 18 MHz Variable Gain Amplifier

The AD8338 is a variable gain amplifier (VGA) for applications that require a fully differential signal path, low power, low noise, and a well-defined gain over frequency. While the inputs are differential, the device can also be driven with a single-ended source if required. The AD8338 includes additional circuit blocks to enable input offset correction and automatic gain control (AGC), offering users additional versatility. With the addition of a few external passive components, users can customize the gain, bandwidth, input impedance, and noise profile of the part to fit their applications.

The AD8338 uses a single supply voltage of 3.0 V to 5.0 V and is very power efficient, consuming as little as 3 mA quiescent current at mid gain. It is available in a 3 mm × 3 mm, RoHS compliant, 16-lead LFCSP and is specified over the industrial temperature range of -40°C to +85°C.

Features

- Voltage controlled gain range of 0 dB to 80 dB
- 3 mA supply current at gain of 40 dB
- Low frequency (LF) to 18 MHz operation
- Supply range: 3.0 V to 5.0 V
- Low noise: 4.5 nV/√Hz at 80 dB gain
- Fully differential signal path
- Offset correction (offset null) feature
- Internal 1.5 V reference
- 16-lead LFCSP
- Automatic gain control feature
- Wide gain range for high dynamic range signals

Applications

- Front end for inductive telemetry systems
- Ultrasonic signal receivers
- Single compression for driving an ADC
- AGC amplifiers

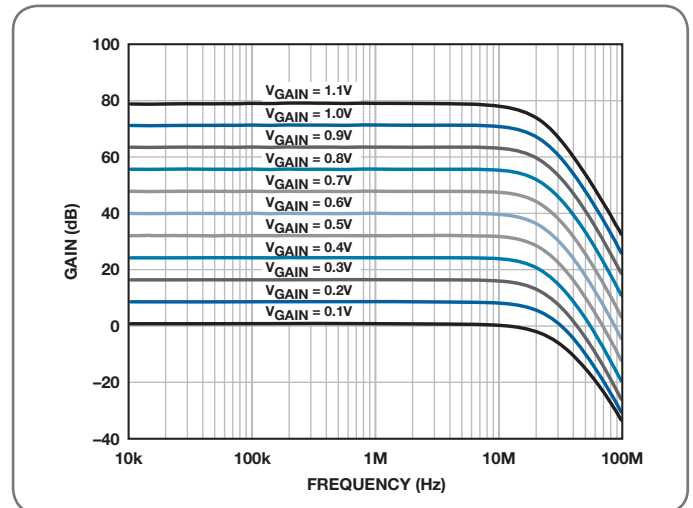

Gain vs. frequency

Variable Gain Amplifiers

Part Number	Number of Amps	Frequency Range to -3 dB MHz	Gain Scaling ¹		Gain Range dB	Gain Accuracy dB	Preamp	E _n nV/√Hz	Output Noise (Max Gain) nV/√Hz	Supply Voltage (V)	Package	Price @ 1k (OEM \$US)
			Linear-in-dB	Linear								
<i>Analog Control</i>												
AD603	1	DC to 90	40	—	-11 to +31 +9 to +51	±0.5	No	1.3	46	±4.75 to ±6.3	SOIC-8/DIP-8	5.58
AD604	2	DC to 40	20 to 40	—	0 to +48 +6 to +54	±0.3	Yes	1.8	200	±5	SOIC-8/DIP-8	16.78
AD605	2	DC to 40	20 to 40	—	-14 to +34 0 to 48	±0.2	No	1.8	94	5	SOIC-8/DIP-8	10.00
AD8264	4	235	20	—	0 to 24	±0.25	Yes	2.3	72	±2.5 to ±5	LFCSP-40	11.95
AD8330	1	DC to 150	33.3	2	-30 to +70	±0.5	No	5	62	2.7 to 6	LFCSP-16 QSOP-16	4.53
AD8331	1	DC to 120	50	—	-5 to +43 +7 to +55	±0.3	Yes	0.8	170	4.5 to 5.5	QSOP-20	5.45
AD8332/ AD8334	2/ 4	DC to 100	50	—	-5 to +43 +7 to +55	±0.3	Yes	0.8	150	4.5 to 5.5	TSSOP-28 LFCSP-32	10.78 14.66
AD8335	4	DC to 85	20	—	-10 to +38 -2 to +46	±0.2	Yes	1.3	80	4.5 to 5.5	LFCSP-64	12.14
AD8336	1	DC to 100	50	—	-14 to +46 0 to 60	±0.2	Yes	3	600	±3 to ±12	LFCSP-16	4.05
AD8337	1	DC to 280	19.7	—	0 to 24	±0.25	Yes	2.2	34	±2.5 to ±5	LFCSP-8	2.49
AD8338	1	DC to 20	80	—	0 to 80	±0.3	No	4.5	—	3.0 to 5.5	LFCSP-16	4.81
AD8340	1	700 to 1000	—	2	-2 to -32	±0.25	No	—	-149 dBm/Hz	4.75 to 5.25	LFCSP-24	7.59
AD8341	1	1.5 GHz to 2.4 GHz	—	2	-4 to -34	±0.25	No	—	-151 dBm/Hz	4.75 to 5.25	LFCSP-24	7.59
AD8367	1	DC to 500	45	—	-2.5 to +42.5	±0.2	No	1.9	—	2.7 to 5.5	TSSOP-14	4.60

¹Gain scaling-analog control: dB/V and V/V; digital control: dB/LSB and V/V/LSB.

Variable Gain Amplifiers (continued)

Part Number	Number of Amps	Frequency Range to -3 dB MHz	Gain Scaling ¹		Gain Range dB	Gain Accuracy dB	Preamp	E _n nV/√Hz	Output Noise (Max Gain) nV/√Hz	Supply Voltage (V)	Package	Price @ 1k (OEM \$US)
			Linear-in-dB	Linear								
<i>Analog Control</i>												
AD8368	1	LF to 800	34	—	-12 to +22	±0.4	No	1.3	-143 dBm/Hz	4.5 to 5.5	LFCSP-24	4.60
ADL5330	1	1 MHz to 3 GHz	22	—	-34 to +22	±1.5	Yes	1.3	-150 dBm/Hz	4.75 to 6	LFCSP-24	5.04
ADL5331	1	1 MHz to 1.2 GHz	Yes	—	-15 to +15	0.09	No	—	-150 dBm/Hz	5	LFCSP-24	5.16
ADL5336	2	LF to 1 GHz	Yes	—	-15 to +20	±0.2	No	—	—	5	LFCSP-32	6.57
ADL5390	2	20 MHz to 2.4 GHz	—	3.5	+5 to -27	±0.25	No	4.7	-149 dBm/Hz	4.75 to 5.25	LFCSP-24	7.59
ADL5391	1	DC to 2.0 GHz	—	1	0 to -42	±0.03	No	—	-133 dBm/Hz	4.5 to 5.5	LFCSP-16	4.95
ADL5390	2	20 MHz to 2.4 GHz	—	3.5	5 to -27	±0.25	No	4.7	-149 dBm/Hz	4.75 to 5.25	LFCSP-24	7.59
ADL5391	1	DC to 2.0 GHz	—	1	0 to -42	±0.5	No	4.7	-133 dBm/Hz	4.5 to 5.5	LFCSP-24	4.95
ADRF6510	2	1 to 30	Yes	—	-5 to 45	—	Yes	—	-130 dBV/Hz	5	LFCSP-32	8.99
ADRF6516	2	1 to 31	Yes	—	-5 to +45	0.2	Yes	—	-141 dBV/Hz	3.3	LFCSP-32	10.30
ADRF6518	2	1 to 63	Yes	—	-6 to +66	±0.1	Yes	—	-104.3 dBV/Hz	3.3	LFCSP-32	11.95
<i>Digital Control</i>												
AD8260	1	230	—	—	30	±0.15 typ	Yes	2.4	38	3.3 to 10	LFCSP-32	3.84
AD8366	2	DC to 500	0.25	—	4.5 to 20.5	—	No	—	—	5	LFCSP-32	6.57
AD8369	1	0.001 to 600	45	—	-5 to +40	±0.5	No	2	—	3.0 to 5.5	TSSOP-16	4.25
AD8370	1	0.001 to 700	—	28	-11 to +17 +6 to +34	±0.5	Yes	2.1	—	2.7 to 5.5	TSSOP-16	4.25
AD8372	2	1 to 130	41	—	-9 to +32	±0.2	No	—	—	4.5 to 5.5	LFCSP-32	6.58
AD8375	1	630	20	—	-4 to +20	±0.2	No	1.9	—	4.5 to 5.5	LFCSP-24	4.54
AD8376	2	700	20	—	-4 to +20	±0.2	No	2	—	4.5 to 5.5	LFCSP-32	6.57
ADL5201	1	700	Yes	—	-11.5 to +20	±0.03	No	—	—	5	LFCSP-24	4.54
ADL5202	2	700	Yes	—	-11.5 to +20	±0.03	No	—	—	5	LFCSP-40	6.57
ADL5240	1	100 MHz to 4 GHz	Yes	—	-13.5 to +18	±0.25	No	—	—	5	LFCSP-32	3.50
ADL5243	1	100 MHz to 4 GHz	Yes	—	+3.5 to +35	±0.25	No	—	—	5	LFCSP-32	5.79
<i>Digitally Controlled Line Drivers</i>												
AD8324	1	100	1	—	-25.5 to +33.5	±1.0	Yes	1.3	157	3.3	LFCSP-20 QSOP-20	1.35
AD8325	1	100	1	—	-29.45 to +30.0	±0.3	Yes	—	—	5	TSSOP-28	3.34
ADA4320-1	1	140	1	—	-27 to +32	±1.0	Yes	0.8	230	5	LFCSP-24	2.15

¹ Gain scaling-analog control: dB/V and V/V; digital control: dB/LSB and V/V/LSB.

Amplifier and Standard Linear Selection Guide

Voltage References—Series Modes

ADR3412/ADR3420/ADR3425/ADR3430/ADR3433/ADR3440/ADR3450: Micropower, High Accuracy Voltage References

The ADR34xx series is a family of low cost, low power, high precision CMOS voltage references, featuring $\pm 0.1\%$ initial accuracy, low operating current and low output noise in a small SOT-23 package. Stability and system reliability are further improved by the low output voltage hysteresis of the device and low long-term output voltage drift. Furthermore, the low operating current of the device (100 μA maximum) facilitates usage in low power devices, and its low output noise helps maintain signal integrity in critical signal processing systems. The ADR34xx series comes in 6 different output voltages (1.2 V, 2.048 V, 2.5 V, 3.0 V, 3.3 V, 4.096 V, and 5.0 V) all of which are specified over the extended industrial temperature range of -40°C to $+125^\circ\text{C}$.

Features

- Initial accuracy: $\pm 0.1\%$ maximum
- Maximum temperature coefficient: 8 ppm/ $^\circ\text{C}$
- Operating temperature range: -40°C to $+125^\circ\text{C}$
- Output current: +10 mA source/−3 mA sink
- Low quiescent current : 100 μA (maximum)
- Low dropout voltage : 250 mV at 2 mA
- Output noise (0.1 Hz to 10 Hz) : <10 $\mu\text{Vp-p}$ at 1.2 V (typical)
- 6-lead SOT-23

Applications

- Precision data acquisition systems
- Industrial instrumentation
- Medical devices
- Battery-powered devices

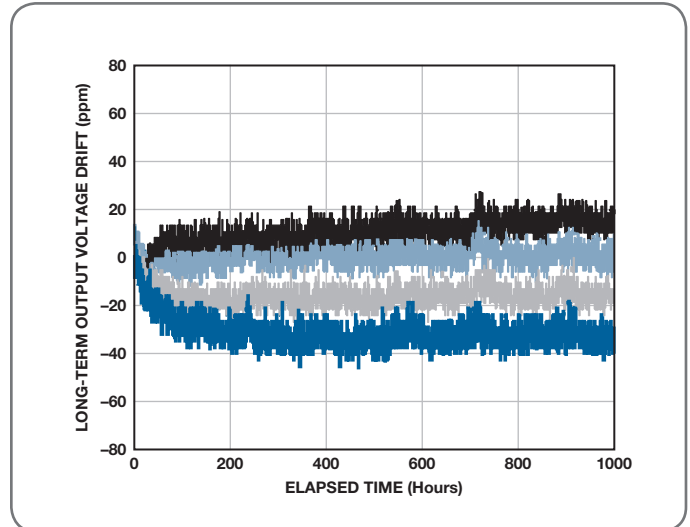

Long-term drift performance.

ADR4520/ADR4525/ADR4530/ADR4533/ADR4540/ADR4550: Ultralow Noise, High Accuracy Voltage References

The ADR45xx series of devices are high precision, low power, low noise voltage references, featuring $\pm 0.02\%$ maximum initial error, excellent temperature stability and low output noise. This family of voltage references employs a new core topology for high accuracy, while offering industry-leading temperature stability and noise performance. The devices' low thermally induced output voltage hysteresis and low long-term output voltage drift also improve system accuracy over time and temperature variations. The ADR45xx series references are available in a wide range of output voltages, in an SOIC package, all of which are specified over the extended industrial temperature range of -40°C to $+125^\circ\text{C}$.

Features

- Maximum temperature coefficient (TCV_{OUT}): 2 ppm/ $^\circ\text{C}$
- Output noise (0.1 Hz to 10 Hz)
 - Less than 1 $\mu\text{V p-p}$ at V_{OUT} of 2.048 V typical
- Initial output voltage error: $\pm 0.02\%$ (maximum)
- Input voltage range: 3 V to 15 V
- Operating temperature: -40°C to $+125^\circ\text{C}$
- Output current: +10 mA source/−10 mA sink
- Low quiescent current: 950 μA (maximum)
- Low dropout voltage: 300 mV at 2 mA (V_{OUT} \geq 3 V)
- 8-lead SOIC package

Applications

- Precision data acquisition systems
- High resolution data converters
- High precision measurement devices
- Industrial instrumentation
- Medical devices
- Automotive batter monitoring

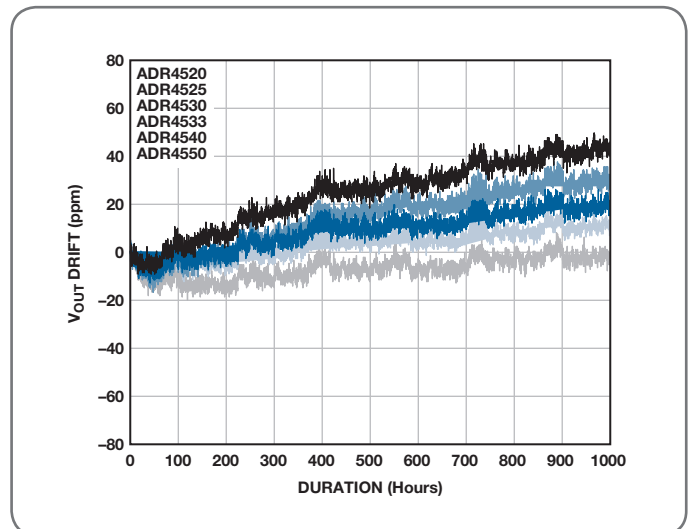

Long-term drift performance.

Series Mode Voltage References

Part Number	Output Voltage (V)	Initial Accuracy (%)	Supply Voltage Range (V)	I _{SY} (μA)	Tempco (ppm/°C)	Output Current Source/Sink (mA)	0.1 Hz to 10 Hz Noise (μV p-p)	Low Dropout Device	Package						Price @ 1k (OEM \$US)
									SC-70	SOT-23	MSOP	TSSOP	SOIC	Other ¹	
ADR130	0.5	0.35, 0.70	2.0 to 18	150	25, 50	4/2	3	•		•					0.92/1.51
ADR130	1	0.35, 0.70	2.0 to 18	150	25, 50	4/2	6	•		•					0.92/1.51
ADR3412	1.2	0.1	2.3 to 5.5	100	8	10/3	8			•					0.93
ADR127	1.25	0.12, 0.24	2.7 to 18	125	9, 25	5/2	9	•		•					1.11/1.83
ADR827	1.25	0.2, 0.4	2.7 to 15	400	15, 30	5/3	8	•			•				1.45
ADR3420	2.048	0.1	2.3 to 5.5	100	8	10/3	15	•		•					0.93
ADR4520	2.048	0.02, 0.04	3 to 15	950	2, 4	10/10	1	•					•		2.45/3.45
ADR430	2.048	0.05, 0.15	4.1 to 18	800	3, 10	10/10	3.5				•		•		2.96/4.34
ADR440	2.048	0.05, 0.15	3 to 18	3750	3, 10	10/5	1	•			•		•		2.78/3.91
ADR360	2.048	0.15, 0.29	2.35 to 15	190	9, 25	5/1	6.8	•		•					0.84/1.29
ADR420	2.048	0.05, 0.15	4.0 to 18	600	3, 10	10	1.75				•		•		2.88/4.43
REF191	2.048	0.1, 0.49	3.0 to 15	45	5, 25	25	20	•					•		1.44/2.59
ADR380	2.048	0.24	2.4 to 18	140	25	5	5	•		•					0.78
ADR3425	2.5	0.1	2.7 to 5.5	100	8	10/3	18	•		•					0.93
ADR3525W	2.5	0.1	2.7 to 5.5	100	5, 8	10/3	18	•			•				1.14/1.90
ADR4525	2.5	0.02, 0.04	3.0 to 15	950	2, 4	10/10	1.25	•					•		2.45/3.45
ADR431	2.5	0.04, 0.12	4.5 to 18	800	3, 10	10/10	3.5				•		•		2.96/4.41
ADR441	2.5	0.04, 0.12	3.0 to 18	3750	3, 10	10/5	1.2	•			•		•		2.78/3.91
ADR361	2.5	0.12, 0.24	2.8 to 15	190	9, 25	5/1	8.25	•		•					0.82/1.29
ADR421	2.5	0.04, 0.12	4.5 to 18	600	3, 10	10	1.75				•		•		2.88/4.43
AD780	2.5	0.04, 0.2	4.0 to 36	1 mA	3, 7	10/10	4						•	•	4.18/6.32
ADR03	2.5	0.1, 0.2	4.5 to 36	1 mA	3, 9, 10, 25	10	6		•	•			•		1.05/2.28
AD584	2.5	0.1, 0.14, 0.3	5.0 to 30	1 mA	10, 15, 30	5	50							•	3.17/6.26
REF192	2.5	0.08, 0.2, 0.4	3.0 to 15	45	5, 10, 25	25	25	•				•	•		1.44/2.59
ADR291	2.5	0.08, 0.12, 0.24	3.0 to 15	15	10, 20, 30	5	8	•				•	•		1.82/5.66
ADR391	2.5	0.16, 0.24	2.8 to 15	140	9, 25	5	5	•		•					0.88/1.35
AD680	2.5	0.2, 0.4	4.5 to 36	280	20, 25, 30	10	10						•	•	1.84/3.47
ADR381	2.5	0.24	2.8 to 18	140	25	5	5	•		•					0.78
AD1582	2.5	0.08, 0.8	2.7 to 12	70	50, 100	5/5	70	•		•					0.62/0.86
REF03	2.5	0.6	4.5 to 33	1.4 mA	50	10/0.5	6						•	•	1.25
ADR3430	3	0.1	3.2 to 5.5	100	8	10/3	22	•		•					0.93
ADR3530W	3	0.1	3.2 to 5.5	100	5, 8	10/3	22	•			•				1.14/1.90
ADR4530	3	0.02, 0.04	3.1 to 15	950	2, 4	10/10	1.6	•					•		2.45/3.45
ADR433	3	0.05, 0.13	5.0 to 18	800	3, 10	10/10	3.75				•		•		2.96/4.41
ADR363	3	0.1, 0.2	3.3 to 15	190	9, 25	5/1	8.7	•		•					0.82/1.29
ADR423	3	0.04, 0.13	5.0 to 18	600	3, 10	10	2				•		•		2.88/4.43
ADR06	3	0.1, 0.2	5.0 to 36	1 mA	3, 9, 25	10	10		•	•			•		1.05/2.17
ADR443	3	0.04, 0.13	3.5 to 18	3750	3, 10	10/5	1.4	•			•		•		2.78/3.91
REF193	3	0.33	3.3 to 15	45	25	25	30	•					•		1.43
AD1583	3	0.1, 1.0	3.2 to 12	70	50, 100	5/5	85	•		•					0.62/0.86
ADR3433	3.3	0.1	3.5 to 5.5	100	8	10/3	25	•		•					0.93
ADR3533W	3.3	0.1	3.5 to 5.5	100	5, 8	10/3	25	•			•				1.14/1.90
ADR4533	3.3	0.02, 0.04	3.4 to 15	950	2, 4	10/10	2.1	•					•		2.45/3.45
REF196	3.3	0.3	3.5 to 15	45	25	25	33	•				•	•		1.44
ADR366	3.3	0.12, 0.25	3.6 to 15	190	9, 25	5/1	9.3	•		•					0.78/1.22
ADR3440	4.096	0.1	4.3 to 5.5	100	8	10/3	29	•		•					0.93
ADR3540W	4.096	0.1	4.3 to 5.5	100	5, 8	10/3	29	•			•				1.14/1.90

¹ DIP, TO-52, TO-99 package offerings.

Series Mode Voltage References (continued)

Part Number	Output Voltage (V)	Initial Accuracy (%)	Supply Voltage Range (V)	I _{SV} (μA)	Tempco (ppm/°C)	Output Current Source/Sink (mA)	0.1 Hz to 10 Hz Noise (μV p-p)	Low Dropout Device	Package						Price @ 1k (OEM \$US)	
									SC-70	SOT-23	MSOP	TSSOP	SOIC	Other ¹		
ADR4540	4.096	0.02, 0.04	4.2 to 15	950	2, 4	10/10	2.7	•						•	2.45/3.45	
ADR434	4.096	0.04, 0.12	6.1 to 18	800	3, 10	10/10	6.25				•			•	2.96/4.41	
REF198	4.096	0.05, 0.12, 0.24	4.5 to 15	45	5, 10, 25	25	40	•					•	•	1.44/2.59	
ADR292	4.096	0.07, 0.1, 0.15	4.5 to 15	15	10, 20, 30	5	12	•				•	•		1.82/5.66	
ADR444	4.096	0.04, 0.13	4.6 to 18	3750	3, 10	10/5	1.8	•			•			•	2.53/3.29	
ADR364	4.096	0.1, 0.2	4.4 to 15	190	9, 25	5/1	11	•		•					0.82/1.29	
ADR392	4.096	0.12, 0.15	4.3 to 15	140	9, 25	5	7	•		•					0.88/\$1.35	
AD1584	4.096	0.1, 0.98	4.3 to 12	70	50, 100	5/5	110	•		•					0.62/0.86	
REF194	4.5	0.04, 0.2	4.75 to 15	45	5, 25	25	45	•						•	1.44/2.37	
ADR3450	5	0.1	5.2 to 5.5	100	8	10/3	35	•		•					0.93	
ADR3550W	5	0.1	5.2 to 5.5	100	5, 8	10/3	35	•				•			1.14/1.90	
ADR4550	5	0.02, 0.04	5.1 to 15	950	2, 4	10/10	2.8	•						•	2.45/3.45	
AD588	±5	0.02, 0.06, 0.1	±18	10 mA	1.5, 3	10/10	6							•	•	18.07
AD586	5	0.04	10.8 to 36	3 mA	2, 5, 10	10/10	4							•	•	3.01/5.07/6.96
ADR435	5	0.04, 0.12	7.0 to 18	800	3, 10	10/10	8				•			•	2.96/4.41	
ADR425	5	0.04, 0.12	7.0 to 18	600	3, 10	10	3.4				•			•	2.88/4.43	
ADR02	5	0.06, 0.1	7.0 to 36	1 mA	3, 9, 10, 25, 40	10	10			•	•			•	1.05/2.28	
AD584	5	0.06, 0.12, 0.3	7.5 to 30	1 mA	5, 15, 30	5/5	50								•	3.17/6.26
REF195	5	0.04, 0.1, 0.2	5.15 to 15	45	5, 10, 25	25	50	•				•	•	•	1.44/2.37	
ADR365	5	0.08, 0.16	5.3 to 15	190	9, 25	5/1	12.8	•		•					0.82/1.26	
ADR445	5	0.04, 0.12	5.5 to 18	3750	3, 10	10/5	2.25	•			•			•	2.78/3.91	
ADR293	5	0.06, 0.2	6.0 to 15	20	8, 25	5	15					•	•		1.90/5.66	
REF02	5	0.3	8.0 to 36	1.4 mA	8.5, 25, 65	10	15							•	•	1.25/2.23
ADR395	5	0.1, 0.12	5.3 to 15	140	9, 25	5	8	•		•					0.88/1.35	
AD1585	5	0.1, 1.0	5.2 to 12	70	50, 100	5/5	140	•		•					0.62/0.86	
AD584	7.5	0.05, 0.1, 0.27	10 to 30	1 mA	5, 15, 30	5/5	50								•	3.17/6.26
AD588	±10	0.05, 0.01, 0.03	12 to 36	10 mA	1.5, 3	10/10	6							•	•	18.07
AD688	±10	0.015, 0.03	±13.5 to 18	12 mA	3, 8	10/10	6							•	•	9.37/30.19
ADR01	10	0.05, 0.1	12 to 36	1 mA	3, 9, 10, 25	10	20			•	•			•	1.05/2.17	
AD587	10	0.05, 0.1	13.5 to 36	4 mA	10, 20	10/10	4							•	•	2.65/3.44
AD581	10	0.05, 0.1, 0.3	13 to 30	1 mA	5, 10, 15, 30	5	40								•	7.14
AD584	10	0.05, 0.1, 0.3	12.5 to 30	1 mA	5, 15, 30	5/5	50								•	3.17/6.26
REF01	10	0.3	12 to 36	1.4 mA	8.5, 25, 65	10	30							•	•	1.24

¹ DIP, TO-52, TO-99 package offerings

Amplifier and Standard Linear Selection Guide

Voltage References—Shunt Mode

ADR5040/ADR5041/ADR5043/ADR5044/ADR5045: Precision, Micropower Shunt Mode Voltage References

The ADR504x series are high precision shunt voltage references, housed in ultrasmall SC70 and SOT-23 packages. These voltage references are multipurpose, easy to use references that can be used in a vast array of applications. They feature low temperature drift, an initial accuracy of better than 0.1%, and fast settling time. The advanced design of the ADR504x series eliminates the need for compensation by an external capacitor, yet the references are stable with any capacitive load. The minimum operating current increases from 50 μA to a maximum of 15 mA. This low operating current and ease of use make these references ideally suited for handheld, battery-powered applications. This family of references is available in output voltages of 2.048 V, 2.5 V, 3.0 V, 4.096 V, and 5.0 V, and has been characterized over the extended temperature range of -40°C to $+125^{\circ}\text{C}$.

Features

- Ultracompact SC70 and SOT-23 packages
- Low temperature coefficient: 75 ppm/ $^{\circ}\text{C}$ (maximum)
- Pin-compatible with LM4040/LM4050
- Initial accuracy: $\pm 0.1\%$
- No external capacitor required
- Wide operating current range: 50 μA to 15 mA
- Extended temperature range: -40°C to $+125^{\circ}\text{C}$
- Qualified for automotive applications

Applications

- Portable, battery-powered equipment
- Automotive
- Power supplies
- Data acquisition systems
- Instrumentation and process control
- Energy management

Shunt Mode Voltage References

Part Number	Output Voltage (V)	Initial Accuracy (%)	Current Range		Tempco (ppm/ $^{\circ}\text{C}$)	Output Impedance (Ω)	0.1Hz to 10 Hz Noise ($\mu\text{V p-p}$)	Package					Price @ 1k (OEM \$US)		
			Min (μA)	Max (mA)				SC-70	SOT-23	MSOP	TSSOP	SOIC		Other ¹	
ADR510	1	0.35	100	10	85	0.3	4		•						0.61
AD589	1.2	1.2	50	5	10, 50, 100	0.6	–						•	•	1.39
ADR512	1.2	0.3	100	10	60	0.3	4		•						0.61
AD1580	1.225	0.08, 0.8	50	10	50, 100	0.5		•	•						0.62/0.86
ADR1581	1.25	0.08, 0.8	60	10	50, 100	0.5	4.5		•						0.61/0.84
ADR1500	1.288	0.2	50	10	220	1	5	•							1.03
ADR5040	2.048	0.1, 0.2	50	15	75, 100	0.2	16.8	•	•						0.30/0.38
ADR5041	2.5	0.1, 0.2	50	15	75, 100	0.2	19.2	•	•						0.30/0.38
ADR525	2.5	0.2, 0.4	50	15	40, 70	0.27	18	•	•						0.49/0.93
ADR5043	3	0.1, 0.2	50	15	75, 100	0.2	25.8	•	•						0.30/0.38
ADR530	3	0.2, 0.4	50	15	40, 70	0.27	22	•	•						0.49/1.01
ADR5044	4.096	0.1, 0.2	50	15	75, 100	0.2	32.2	•	•						0.30/0.38
ADR5045	5	0.1, 0.2	50	15	75, 100	0.2	39.6	•	•						0.30/0.38
ADR550	5	0.2, 0.4	50	15	40, 70	0.27	48	•	•						0.49/0.93

¹DIP, TO-52, or TO-99 package offerings.

Amplifier and Standard Linear Selection Guide

ADC Drivers

ADC driver amplifiers perform many important functions, including buffering, amplitude scaling, single-ended-to-differential and differential-to-single-ended conversion, common-mode offset adjustment, and filtering. ADC drivers have become essential signal conditioning elements in data conversion stages and are key factors in enabling the ADC function to achieve its rated performance.

ADI offers a complete portfolio of driver amplifiers covering a wide-range of SAR, pipeline, and Σ - Δ analog-to-digital converter applications.

ADC Drivers

Part Number	No. of Amps	Supply Voltage (V)	Rail-to-Rail ¹	A _{CL} Min	-3 dB Bandwidth (MHz)	Slew Rate (V/ μ s)	Distortion (2nd) (dBc)	Distortion (3rd) (dBc)	Test Frequency (MHz)	Noise (nV/ \sqrt Hz)	V _{OS} Max (mV)	Supply Current	Packaging	Price @ 1k (OEM \$US)
AD8132	1	2.8/11		1	350	1200	-100	-99	5	8	1	10.7	SOIC/MSOP	1.67
AD8137	1	3/11	RRO	1	110	450	-100	-105	5	8.3	2.6	3.6	LFCSP/SOIC	1.10
AD8138	1	3/11		1	320	1150	-94	-114	5	5	1	20	SOIC/MSOP	3.75
AD8139	1	3/11	RRO	1	410	800	-90	-105	5	2.3	500 μ V	24.5	LFCSP/SOIC	3.75
AD8275	1	3.3/15	RRO	0.2	15	25	-100	-100	100 kHz		500 μ V	1.9	MSOP	1.60
AD8350	1	4/11		5.6	900	2000	-66	-65	50	1.7		28	MSOP/SOIC	2.52
AD8351	1	3/5.5		1	2.2 GHz	13000	-79	-81	70	2.7		28	MSOP	2.68
AD8352	1	3/5.5		2	2.2 GHz	9000	-83	-82	140	2.7	60	37	LFCSP	3.53
AD8366	2	4.75/5.25			600	11000	-96	-90	10			180	LFCSP	6.57
AD8370	1	3/5.5			750	5750	-65	-62	70	2.1		79	TSSOP	4.25
AD8372	2	4.5/5.5			130		-78	-85	65			212	LFCSP	6.58
AD8375	1	4.5/5.5			630	5000	-85	-92	200	1.9		125	LFCSP	4.54
AD8376	2	4.5/5.5			700	5000	-82	-91	200	2		250	LFCSP	6.57
AD8475	1	3/10	RRO	0.4	150	50	-110	-108	100 kHz		200 μ V	3	LFCSP/MSOP	1.99
AD8476	1	3/18	RRO	1	5	10	-120	-130	10 kHz		200 μ V	300 μ A	LFCSP/MSOP	1.99
ADA4922-1	1	5/26		2	38	730	-116	-109	10 kHz	12	1.1	9.4	LFCSP/SOIC	3.63
ADA4927-1	1	4.5/11		1	2.3 GHz	5000	-87	-89	100	1.4	1.3	22.1	LFCSP	3.79
ADA4927-2	2	4.5/11		1	2.3 GHz	5000	-87	-89	100	1.4	1.3	22.1	LFCSP	6.29
ADA4930-1	1	3/5.25		1	1.35 GHz	3400	-104	-101	10	1.2	3.1	34	LFCSP	3.79
ADA4930-2	2	3/5.25		1	1.35 GHz		-104	-101	10	1.2	3.1	34	LFCSP	6.29
ADA4932-1	1	3/11		1	560	410	-104	-120	10	3.6	2.2	9.6	LFCSP	2.95
ADA4932-2	2	3/11		1	560	410	-100	-120	10	3.6	2.2	9.6	LFCSP	5.29
ADA4937-1	1	3.3/5		1	1.9 GHz	6000	-77	-84	100	2.2	2.5	39.5	LFCSP	3.79
ADA4937-2	2	3/5.25		1	1.9 GHz	6000	-77	-84	100	2.2	2.5	39.5	LFCSP	5.69
ADA4938-1	1	4.5/11		1	1 GHz	4700	-82	-82		2.6	1	37	LFCSP	3.79
ADA4938-2	2	4.5/11		1	1 GHz	4700	-82	-82	50	2.6	1	37	LFCSP	5.69
ADA4939-1	1	3/5.25		2	1.4 GHz	6800	-83	-97	70		3.4	37.7		3.79
ADA4939-2	2	3/5.25		2	1.4 GHz	6800	-77	-91	70		3.4	37.7		5.69
ADA4940-1	1	3/7	RRO	1	260	95	-123	-126	50 kHz	3.9	0.4	1.18	LFCSP/SOIC	1.59
ADA4940-2	2	3/7	RRO	1	260	95	-123	-126	50 kHz	3.9	0.4	1.25	LFCSP	2.59
ADA4941-1	1	2.7/12	RRO	2	30	22	-112	-110	100 kHz		0.8	2.3	LFCSP/SOIC	2.42
ADA4950-1	1	3/11		1	750	2900	-98	-99	20		2.5	9.5	LFCSP	2.99
ADA4950-2	2	3/11		1	750	2900	-98	-99	20		2.5	9.5	LFCSP	5.29
ADA4960-1	1	4.75/5.25		2	5 GHz	8700	-73	-72	1 GHz	4.8	20	60	LFCSP	6.95
ADL5201	1	4.75/5.5			700	5500	-89	-97	140			110	LFCSP	4.54
ADL5202	2	4.5/5.5			700	5500	-86	-105	140			210	LFCSP	6.57
ADL5561	1	3/3.6		2	2.9 GHz	9800	-95	-87	140	2.1		40	LFCSP	3.68
ADL5562		3/3.6		2	3.3 GHz	9800	-104	-87	140	2.1		80	LFCSP	3.68
ADL5565	1	2.8/5.2		2	6.75 GHz	11000	-108	-103	100	1.52		80	LFCSP	3.68
ADL5566	2	2.8/5.2		1	4.5 GHz	18000	-94.7	-100	100	1.3		160	LFCSP	6.05
ADRF6510	2	4.75/5.25			30		-43.2	-51.2	1			258	LFCSP	8.99
ADRF6516	2	3.15/3.45			31		-82	-71	1			360	LFCSP	10.30

Amplifier and Standard Linear Products for Special Application

Automotive Grade Products

ADI's automotive grade amplifiers and standard linear products are identified by the "W" suffix immediately after the part number. These products are qualified for automotive applications and meet or exceed the rigorous requirements of the automotive industry.

Automotive Grade Products

Generic Number	Material Number	Package	Material Description	Ambient Temperature Range
<i>Precision Operational Amplifiers</i>				
AD8538	AD8538WAUJZ-R7	5-lead TSOT-N/A	Single, low power autozero amp	-40°C to +125°C
AD8544	AD8544WARZ-R7 AD8544WARZ-RL	14-lead SOIC_N-150_MIL 14-lead SOIC_N-150_MIL	Quad, low power, RR	-40°C to +125°C
AD8601	AD8601WARTZ-R7 AD8601WARTZ-RL AD8601WDRTZ-REEL AD8601WDRTZ-REEL7	5-lead SOT_23-N/A 5-lead SOT_23-N/A 5-lead SOT_23-N/A 5-lead SOT_23-N/A	Single, low cost, 8 MHz, RRIO, 5 V, op amp	-40°C to +125°C
AD8602	AD8602WARZ-R7 AD8602WARZ-RL	8-lead SOIC_N-150_MIL 8-lead SOIC_N-150_MIL	Dual, precision CMOS RR op amp	-40°C to +125°C
AD8617	AD8617WARMZ-REEL AD8617WARZ-R7 AD8617WARZ-RL	8-lead MINI_SO-N/A 8-lead SOIC_N-150_MIL 8-lead SOIC_N-150_MIL	Dual, micropower, low cost, RRIO, 5 V op amp	-40°C to +125°C
AD8619	AD8619WARUZ-R7 AD8619WARUZ-RL	TSSOP 4.4 MM TSSOP 4.4 MM	Quad, micropower, low cost, RRIO, 5 V op amp	-40°C to +125°C
AD8628	AD8628WARTZ-R7 AD8628WARTZ-RL AD8628WARZ-R7 AD8628WARZ-RL AD8628WAUJZ-R7 AD8628WAUJZ-RL	5-lead SOT_23-N/A 5-lead SOT_23-N/A 8-lead SOIC_N-150_MIL 8-lead SOIC_N-150_MIL 5-lead TSOT-N/A 5-lead TSOT-N/A	Single, zero-drift, RRIO, 5 V op amp	-40°C to +125°C
AD8629	AD8629WARZ-R7 AD8629WARZ-RL	8-lead SOIC_N-150_MIL 8-lead SOIC_N-150_MIL	Dual, zero-drift, RRIO, 5 V op amp	-40°C to +125°C
AD8630	AD8630WARZ-R7 AD8630WARZ-RL	14-lead SOIC_N-150_MIL 14-lead SOIC_N-150_MIL	Quad, zero-drift, RRIO, 5 V op amp	-40°C to +125°C
AD8639	AD8639WARZ-R7 AD8639WARZ-RL	8-lead SOIC_N-150_MIL 8-lead SOIC_N-150_MIL	Dual, zero-drift, RRIO, 16 V op amp	-40°C to +125°C
AD8646	AD8646WARMZ-R7 AD8646WARMZ-RL AD8646WARZ-R7 AD8646WARZ-RL	8-lead MINI_SO-N/A 8-lead MINI_SO-N/A 8-lead SOIC_N-150_MIL 8-lead SOIC_N-150_MIL	Dual, 24 MHz, RRIO, 5 V op amp	-40°C to +125°C
AD8648	AD8648WARUZ-R7 AD8648WARUZ-RL	14-lead TSSOP_4.4-4.4_MM 14-lead TSSOP_4.4-4.4_MM	Quad, 24 MHz, RRIO, 5 V op amp	-40°C to +125°C
AD8655	AD8655WARMZ-RL	8-lead MINI_SO-N/A	Single, low noise, RRO, DigiTrim CMOS op amp	-40°C to +125°C
AD8656	AD8656WARMZ-REEL	8-lead MINI_SO-N/A	Dual, low noise, RRO, Digitrim CMOS op amp	-40°C to +125°C
AD8666	AD8666WARZ-R7 AD8666WARZ-RL	8-lead SOIC_N-150_MIL 8-lead SOIC_N-150_MIL	Dual, low cost, low noise, 16 V RR CMOS op amp	-40°C to +125°C
AD8668	AD8668WARUZ-R7 AD8668WARUZ-RL	14-lead TSSOP_4.4-4.4_MM 14-lead TSSOP_4.4-4.4_MM	Quad, low cost, low noise, 16 V RR CMOS op amp	-40°C to +125°C
AD8691	AD8691WAUJZ-R7 AD8691WAUJZ-RL	5-lead TSOT-N/A/5-TSOT-N/A	Single, low noise, CMOS op amp	-40°C to +125°C
AD8692	AD8692WARMZ-REEL	8-lead MINI_SO-N/A	Dual, precision CMOS RR op amp	-40°C to +125°C
AD8694	AD8694WARUZ-R7 AD8694WARUZ-REEL	14-lead TSSOP_4.4-4.4_MM 14-lead TSSOP_4.4-4.4_MM	Quad, precision CMOS RR op amp	-40°C to +125°C
ADA4096-2	ADA4096-2WARMZ-R7 ADA4096-2WARMZ-RL	8-lead MINI_SO-N/A 8-lead MINI_SO-N/A	30 V, micropower, OVP, RRIO op amp	-40°C to +125°C
<i>High Speed Operational Amplifiers</i>				
AD8040	AD8040WARUZ-REEL7	14-lead TSSOP_4.4-4.4_MM	Quad, low power, RRIO op amp	-40°C to +125°C
AD8065	AD8065WARTZ-R7	5-lead SOT_23-N/A	Single, 145 MHz, low noise, 5 to 24 V, FastFET op amp	-40°C to +125°C
AD8132	AD8132WARMZ-R7	8-lead MINI_SO-N/A	350 MHz, high bandwidth, fast slew rate, low cost, differential op amp	-40°C to +125°C
AD8137	AD8137WYCPZ-R7	3 mm × 3 mm × 0.75 mm, 8-lead LFCSP	Low power differential ADC driver	-40°C to +125°C
AD8145	AD8145WYCPZ-R7	5 mm × 5 mm × 0.85 mm, 32-lead LFCSP	High CMRR, triple differential-to-single ended video receiver op amp	-40°C to +125°C
ADA4851-1	ADA4851-1WYRJZ-R7	6-lead SOT_23-N/A	Single, high speed, RR, low cost, 130 MHz op amp	-40°C to +125°C
ADA4851-2	ADA4851-2WYRMZ-R7	8-lead MINI_SO-N/A	Dual, high speed, RR, low cost, 130 MHz op amp	-40°C to +125°C
ADA4851-4	ADA4851-4WYRUZ-R7	14-lead TSSOP_4.4-4.4_MM	Quad, high speed, RR, low cost, 130 MHz op amp	-40°C to +125°C
ADA4830-1	ADA4830-1WBPCZ-R7	3 mm × 3 mm × 0.75 mm, 8-lead LFCSP	Single, high speed, 18 V short-to-battery protection differential amplifier	-40°C to +125°C
ADA4830-2	ADA4830-2WBPCZ-R7	3 mm × 3 mm × 0.75 mm, 16-lead LFCSP	Dual, high speed, 18 V short-to-battery protection differential amplifier	-40°C to +125°C
<i>High Speed Video Amplifiers</i>				
ADA4853-3	ADA4853-3WYCPZ-R7	3 mm × 3 mm × 0.85 mm, 16-lead LFCSP	Triple, RRO, ultralow power disables, video op amp	-40°C to +105°C
ADA4891-1	ADA4891-1WARJZ-R7	5-lead SOT_23-N/A	Single, RR, high speed CMOS, video op amp	-40°C to +125°C
ADA4891-2	ADA4891-2WARMZ-R7	8-lead MINI_SO-N/A	Dual, RR, high speed CMOS, video op amp	-40°C to +125°C
ADA4891-4	ADA4891-4WARUZ-R7	14-lead TSSOP_4.4-4.4_MM	Quad, RR, high speed CMOS, video op amp	-40°C to +125°C
ADA4432-1	ADA4432-1WBPCZ-R7 ADA4432-1WBRJZ-R7	3 mm × 3 mm × 0.75 mm, 8-lead LFCSP 6-lead SOT_23-N/A	High speed, short-to-battery protection, video filter amplifier	-40°C to +125°C
ADA4433-1	ADA4433-1WBPCZ-R7	3 mm × 3 mm × 0.75 mm, 8-lead LFCSP	High speed, short-to-battery protection, video filter amplifier	-40°C to +125°C

Automotive-Grade Products (continued)

Generic Number	Material Number	Package	Material Description	Ambient Temperature Range
<i>Instrumentation Amplifiers</i>				
AD8220	AD8220WARMZ AD8220WARMZ-R7 AD8220WARMZ-RL	8-lead MINI_SO-N/A 8-lead MINI_SO-N/A 8-lead MINI_SO-N/A	FET input, RRO, instrumentation amp	-40°C to +125°C
AD8231	AD8231WACPZ-RL	16-lead LFCSP-4X4X0.85	Low voltage, low drift, digitally programmable instrumentation amp	-40°C to +125°C
<i>Current Shunt Monitors</i>				
AD8210	AD8210WYC-P3 AD8210WYRZ AD8210WYRZ-R7 AD8210WYRZ-RL	0-lead CHIP-N/A 8-lead SOIC_N-150_MIL 8-lead SOIC_N-150_MIL 8-lead SOIC_N-150_MIL	High-side, bidirectional, current shunt monitor	-40°C to +125°C
AD8211	AD8211WYRZ-R7 AD8211WYRZ-RL	5-lead SOT_23-N/A 5-lead SOT_23-N/A	High voltage, current shunt monitor	-40°C to +125°C
AD8212	AD8212WYRMZ AD8212WYRMZ-R7 AD8212WYRMZ-RL	8-lead MINI_SO-N/A 8-lead MINI_SO-N/A 8-lead MINI_SO-N/A	High voltage, current shunt monitor, adjustable gain	-40°C to +125°C
AD8213	AD8213WHRMZ AD8213WHRMZ-R7 AD8213WHRMZ-RL	10-lead MINI_SO-N/A 10-lead MINI_SO-N/A 10-lead MINI_SO-N/A	Dual, high voltage, current shunt monitor	-40°C to +150°C
	AD8213WYRMZ AD8213WYRMZ-R7 AD8213WYRMZ-RL	10-lead MINI_SO-N/A 10-lead MINI_SO-N/A 10-lead MINI_SO-N/A	Dual, high voltage, current shunt monitor	-40°C to +125°C
AD8215	AD8215WYRZ AD8215WYRZ-R7 AD8215WYRZ-RL	8-lead SOIC_N-150_MIL 8-lead SOIC_N-150_MIL 8-lead SOIC_N-150_MIL	High voltage, ±0.3% gain error, current shunt monitor	-40°C to +125°C
<i>Current Sense Amplifiers</i>				
AD8417	AD8417WBRMZ AD8417WBRMZ-RL AD8417WBRZ AD8417WBRZ-RL	8-lead MINI-SO-N/A 8-lead MINI-SO-N/A 8-lead SOIC_N-150_MIL 8-lead SOIC_N-150_MIL	Zero-drift, precision current sense amp	-40°C to +125°C
AD8418	AD8418WBRMZ AD8418WBRMZ-RL AD8418WBRZ AD8418WBRZ-RL	8-lead MINI_SO-N/A 8-lead MINI_SO-N/A 8-lead SOIC_N-150_MIL 8-lead SOIC_N-150_MIL	Zero-drift, precision current sense amp	-40°C to 125°C
AD8418A	AD8418AWBRMZ AD8418AWBRMZ-RL AD8418AWBRZ AD8418AWBRZ-RL	8-lead MINI-SO-N/A 8-lead MINI-SO-N/A 8-lead SOIC_N-150_MIL 8-lead SOIC_N-150_MIL	Zero-drift, precision current sense amp	-40°C to +125°C
<i>Difference Amplifiers</i>				
AD8202	AD8202W-KGD-R7	0-lead CHIP-N/A	High common-mode, voltage difference amp DIE	-40°C to +150°C
	AD8202WYC-P3	0-lead CHIP-N/A	High common-mode, voltage difference amp DIE	-40°C to +125°C
	AD8202WYRZ	8-lead MINI_SO-N/A		
	AD8202WYRMZ-RL	8-lead MINI_SO-N/A	High common-mode, voltage difference amp	-40°C to +125°C
	AD8202WYRZ-RL	8-lead SOIC_N-150_MIL 8-lead SOIC_N-150_MIL		
AD8205	AD8205WHRZ AD8205WHRZ-RL	8-lead SOIC_N-150_MIL 8-lead SOIC_N-150_MIL	42 V, single-supply, difference amp	-40°C to +150°C
	AD8205WYRZ AD8205WYRZ-R7 AD8205WYRZ-RL	8-lead SOIC_N-150_MIL 8-lead SOIC_N-150_MIL 8-lead SOIC_N-150_MIL	42 V, single-supply, difference amp	-40°C to +125°C
	AD8206WHRZ AD8206WHRZ-RL	8-lead SOIC_N-150_MIL 8-lead SOIC_N-150_MIL	Single-supply, high common-mode, difference amp	-40°C to +150°C
AD8206	AD8206WYRZ AD8206WYRZ-R7 AD8206WYRZ-RL	8-lead SOIC_N-150_MIL 8-lead SOIC_N-150_MIL 8-lead SOIC_N-150_MIL	Single-supply, high common-mode, difference amp	-40°C to +125°C
	AD8207WBRZ AD8207WBRZ-R7 AD8207WBRZ-RL	8-lead SOIC_N-150_MIL 8-lead SOIC_N-150_MIL 8-lead SOIC_N-150_MIL	Zero-drift, high voltage, difference amp	-40°C to +125°C
	AD8208WBRMZ AD8208WBRMZ-R7 AD8208WBRMZ-RL	8-lead MINI_SO-N/A 8-lead MINI_SO-N/A 8-lead MINI_SO-N/A	High voltage, precision difference amp	-40°C to +125°C
AD8208	AD8208WBRZ AD8208WBRZ-R7 AD8208WBRZ-RL	8-lead SOIC_N-150_MIL 8-lead SOIC_N-150_MIL 8-lead SOIC_N-150_MIL		
	AD8208WHRZ AD8208WHRZ-RL	8-lead SOIC_N-150_MIL 8-lead SOIC_N-150_MIL	High temperature voltage, precision difference amp	-40°C to +125°C
	AD8209WBRMZ AD8209WBRMZ-R7 AD8209WBRMZ-RL	8-lead MINI_SO-N/A 8-lead MINI_SO-N/A 8-lead MINI_SO-N/A	High voltage, precision difference amp with EMI filter	-40°C to +125°C
	AD8216WYRZ AD8216WYRZ-R7 AD8216WYRZ-RL	8-lead SOIC_N-150_MIL 8-lead SOIC_N-150_MIL 8-lead SOIC_N-150_MIL	3 MHz, bidirectional 65 V difference amplifier	-40°C to +125°C

Automotive-Grade Products (continued)

Generic Number	Material Number	Package	Material Description	Ambient Temperature Range
<i>Integrated Analog Front End</i>				
AD8283	AD8283WBCPZ AD8283WBCPZ-RL	72-lead LFCSP-10X10X0.85	Radar receive path AFE: 6-channel LNA/PGA/AAF with ADC	-40°C to +105°C
AD8284	AD8284WCSVZ AD8284WCSVZ-RL	64-lead TQFP_EP-10X10X1.0	Radar receive path AFE: 4-channel MUX with LNA/PGA/AAF with ADC	-40°C to +105°C
<i>Comparators</i>				
AD8465	AD8465WBCPZ-R7 AD8465WBCPZ-WP	12-lead LFCSP-3X3X0.85 12-lead LFCSP-3X3X0.85	RR, fast, 2.5 V to 5.5 V, single-supply, LVDS comparator	-40°C to +125°C
AD8468	AD8468WBKSZ-R7 AD8468WBKSZ-RL	6-lead SC70-N/A 6-lead SC70-N/A	RRI, TTL/CMOS output, comparator	-40°C to +125°C
AD8469	AD8469WBRMZ AD8469WBRMZ-RL	8-lead MINI_SO-N/A 8-lead MINI_SO-N/A	Single-channel, RRI TTL/CMOS, output comparator	-40°C to +125°C
<i>Current Shunt Comparators</i>				
AD8214	AD8214WYRMZ AD8214WYRMZ-R7 AD8214WYRMZ-RL	8-lead MINI_SO-N/A 8-lead MINI_SO-N/A 8-lead MINI_SO-N/A	High voltage, threshold detection, current shunt comparator	-40°C to +125°C
<i>Precision Voltage References</i>				
ADR01	ADR01WARZ-R7 ADR01WARZ-RL	8-lead SOIC_N-150_MIL 8-lead SOIC_N-150_MIL	Precision band gap voltage reference, 10 V	-40°C to +125°C
ADR02	ADR02WARZ-REEL ADR02WARZ-REEL7	8-lead SOIC_N-150_MIL 8-lead SOIC_N-150_MIL	Precision band gap voltage reference, 5 V, 0.1%, 10 ppm/°C	-40°C to +125°C
ADR03	ADR03WARZ-R7 ADR03WARZ-RL	8-lead SOIC_N-150_MIL 8-lead SOIC_N-150_MIL	Precision band gap voltage reference, 2.5 V	-40°C to +125°C
ADR06	ADR06WARZ-R7 ADR06WARZ-RL	8-lead SOIC_N-150_MIL 8-lead SOIC_N-150_MIL	Precision band gap voltage reference, 3 V	-40°C to +125°C
ADR291	ADR291WFRZ-R7 ADR291WFRZ-RL	8-lead SOIC_N-150_MIL 8-lead SOIC_N-150_MIL	Micropower, precision reference, 2.5 V 15 ppm/°C max TC	-40°C to +125°C
ADR3525	ADR3525WARMZ-R7 ADR3525WBRMZ-R7	8-lead MINI_SO-N/A 8-lead MINI_SO-N/A	Micropower, CMOS precision voltage reference, 2.5 V, 8ppm/°C TC	-40°C to +125°C
ADR3530	ADR3530WARMZ-R7 ADR3530WBRMZ-R7	8-lead MINI_SO-N/A 8-lead MINI_SO-N/A	Micropower, CMOS precision voltage reference, 3 V, 8ppm/°C TC	-40°C to +125°C
ADR3533	ADR3533WARMZ-R7 ADR3533WBRMZ-R7	8-lead MINI_SO-N/A 8-lead MINI_SO-N/A	Micropower, CMOS precision voltage reference, 3.3 V, 8ppm/°C TC	-40°C to +125°C
ADR3540	ADR3540WARMZ-R7 ADR3540WBRMZ-R7	8-lead MINI_SO-N/A 8-lead MINI_SO-N/A	Micropower, CMOS precision voltage reference, 4.096 V, 8ppm/°C TC	-40°C to +125°C
ADR3550	ADR3550WARMZ-R7 ADR3550WBRMZ-R7	8-lead MINI_SO-N/A 8-lead MINI_SO-N/A	Micropower, CMOS precision voltage reference, 5 V, 8ppm/°C TC	-40°C to +125°C
ADR365	ADR365WAUJZ-R7 ADR365WAUJZ-RL	5-lead TSOT-N/A 5-lead TSOT-N/A	Low power, voltage reference 5 V with sink/source capability	-40°C to +125°C
ADR366	ADR366WAUJZ-REEL7	5-lead TSOT-N/A	Low power, voltage reference, 2.5 V, 15 ppm/°C max TC with sinks/source	-40°C to +125°C
ADR392	ADR392WBUJZ-R7	5-lead TSOT-N/A	Precision low drift voltage reference, 4.096 V with shut down	-40°C to +125°C
ADR5041	ADR5041WARTZ-R7 ADR5041WBRTZ-R7	3-lead SOT_23_3-N/A 3-lead SOT_23_3-N/A	Micropower, precision shunt mode, voltage reference, 2.5 V	-40°C to +125°C
ADR5044	ADR5044WARTZ-R7 ADR5044WBRTZ-R7	3-lead SOT_23_3-N/A 3-lead SOT_23_3-N/A	Micropower, precision shunt mode voltage reference, 4.096 V	-40°C to +125°C
ADR512	ADR512WARTZ-R7	3-lead SOT_23_3-N/A	Low noise, precision shunt mode voltage reference, 1.2 V	-40°C to +85°C

RRI0: rail-to-rail input/output; RRO: rail-to-rail output; RRI: rail-to-rail input; RR: rail-to-rail

Amplifier and Standard Linear Products for Special Application

Defense and Aerospace Qualified Products

Analog Devices is committed to the establishment and continuous improvement of world class systems and processes aimed at satisfying our customers' evolving need in aerospace and defense applications.

Defense Qualified Products

Precision			High Speed		
Part Number	Model Number	Description	Part Number	Model Number	Description
OP11	5962-89801012A 5962-8980101CA	Quad matched 741-type op amp	AD830	5962-9313001MPA	Video difference amp
OP27	OP27AJ/883C OP27AZ/883C	Low noise, precision op amp	AD713	5962-9063301MCA	Quad precision, low cost, BiFET op amp
OP77	5962-87738012A 5962-8773802GA 5962-8773802PA	Ultralow offset voltage op amp	AD8001	5962-9459301MPA	800 MHz, 50 mW current feedback amplifier
OP400	5962-8777101M3A 5962-8777101MCA	Quad low offset, low power op amp	AD8004	AD8004SQ	Quad 3000 V/ μ s, 35 mW current feedback amplifier
AD712	AD712SQ/883B	Precision, low cost, high speed, BiFET dual op amp	AD8036	5962-9559701MPA	Unity-gain stable, low distortion, wide bandwidth voltage feedback clamp amps
OP470	5962-88565012A 5962-8856501CA	Very low noise, quad op amp	AD8041	5962-9683901MPA	160 MHz rail-to-rail amplifier with disable
OP270	5962-8872101PA	Very low noise dual op amp	AD810	5962-9313201MPA	Low power video op amp with disable
OP471	5962-88565022A 5962-88565023A 5962-8856502CA	High speed, low noise quad op amp	AD811	5962-9313101M2A 5962-9313101MPA AD811SCHIPS AD811SE/883B AD811SQ/883B	High performance video op amp
AD549	AD549SH/883B	Ultralow input-bias current op amp	AD813	5962-9559601M2A	Single-supply, low power triple video amplifier
OP200	5962-8859301MPA 5962-8859301M2A	Dual low offset, low power operational amplifier	AD827	5962-9211701M2A 5962-9313101MPA AD827SCHIPS AD827SE/883B AD827SQ AD827SQ/883B	High performance video op amp
OP97	5962-8954401PA	Low power, high precision op amp	AD829	5962-9312901M2A 5962-9312901MPA AD829SCHIPS AD829SE/883B AD829SQ AD829SQ/883B	Low noise video op amp
AD713	5962-9063301MCA	Precision, high speed, BiFET quad op amp	AD830	5962-9313001MPA	Video difference amplifier
AD708	AD708SQ/883B	Ultralow offset voltage dual op amp	AD843	5962-9098001M2A 5962-9098001MPA 5962-9098001MXA AD843SCHIPS AD843SH/883B AD843SQ AD843SQ/883B	34 MHz, CBFET fast settling op amp
OP249	5962-9151901M2A 5962-9151901MPA	Dual, precision JFET high speed operational amplifier	AD844	5962-8964401PA AD844SCHIPS AD844SQ AD844SQ/883B	60 MHz, 2000 V/ μ s monolithic op amp
AD704	AD704SE/883B	Picoampere input current quad bipolar op amp	AD845	5962-8964501PA AD845SQ AD845SQ/883B	Precision, 16 MHz CBFET op amp
OP497	5962-9452101M2A	Precision picoampere input current quad operational amplifier	OP249	5962-9151901M2A 5962-9151901MPA OP249AZ	Dual, precision JFET high speed operational amplifier

Aerospace Qualified Products – Precision Op Amps

Part Number	Model Number	Package	Description
<i>Low Offset</i>			
AD8629S	AD8629D703L	10-lead FP	Zero-drift, single-supply, rail-to-rail input/output op amp
AD8671S	5962L0922301VHA	10-lead FP	Single, very low noise, low input bias current op amp
OP07S	5962R9863901VGA	8-lead can	Ultralow offset voltage op amp
	5962R9863901VHA	10-lead FP	
	5962R9863901VPA	8-lead DIP	
	OP07000C	Class K die	
OP22S	OP220903J	8-lead can	Programmable micropower op amp
	5962R9468002VGA	8-lead can	
OP27S	5962R9468002VHA	10-lead FP	Low noise, precision op amp
	5962R9468002V2A	20-lead LCC	
	5962R9468002VPA	8-lead DIP	
	OP484-000C	Class K die	
OP37S	5962-8853701VGA	8-lead can	Low noise, precision high speed op amp
	5962-8853701VPA	8-lead DIP	
OP77S	5962-8773802VGA	8-lead can	Ultralow offset voltage operational amplifier
	5962-8773802VHA	10-lead FP	
	5962-8773802V2A	20-lead LCC	
	5962-8773802VPA	8-lead DIP	
OP200S	5962-8859301V2A	20-lead LCC	Dual low offset, low power op amp
	5962-8859301VPA	8-lead DIP	
OP207S	5962R0821401VCA	14-lead DIP	Dual ultralow V_{OS} matched op amp
OP227S	OP227R903Y	14-lead DIP	Dual low noise, low offset instrumentation op amp
	OP227R903M	14-lead FP	
OP270S	5962-8872101VPA	8-lead DIP	Dual very low noise, precision op amp
	5962-8872101VDA	14-lead FP	
	5962-8872101V2A	20-lead LCC	
	5962R8872101VPA	8-lead DIP	
	5962R8872101VDA	14-lead FP	
	5962R8872101V2A	20-lead LCC	
	OP270R000C	Class K die	
OP400S	5962-8777101VKA	24-lead FP	Quad low offset, low power op amp
	5962-8777101V3A	28-lead LCC	
	5962-8777101VCA	14-lead DIP	
	OP400-000C	Class K die	
OP484S	5962-0051701VCA	14-lead DIP	Rail-to-rail input and output op amp
	5962-0051701VDA	14-lead FP	
	5962R0051701VCA	14-lead DIP	
	5962R0051701VDA	14-lead FP	
	OP484-000C	Class K die	
<i>Low Input Bias</i>			
AD648S	5962-9753501VGA	6-lead can	Dual low power BiFET op amp
	5962-9753501VPA	8-lead DIP	
	5962-9753502VGA	6-lead can	
	5962-9753502VPA	8-lead DIP	
OP12S	OP120903J	8-lead can	Precision low input current operational amplifier
	OP120000C	Class K die	
OP15S	5962R8954203VGA	6-lead can	Precision JFET input op amp
	5962R8954203VHA	10-lead FP	
	5962R8954203VPA	8-lead DIP	
OP16S	5962R8954304VGA	6-lead can	Precision JFET input op amp
	5962R8954304VPA	8-lead DIP	
OP42S	5962-8851301VGA	6-lead can	
	5962-8851301VPA	8-lead DIP	
OP215S	5962-8853801VGA	6-lead can	Dual precision JFET input op amp
	5962-8853801VPA	8-lead DIP	
	5962R8853801VGA	6-lead can	
	5962R8853801VPA	8-lead DIP	
	5962R8853804V2A	20-lead LCC	
	OP215-000C	Class K die	
	OP215R000C	Class K die	

Aerospace Qualified Products – Precision Op Amps

Part Number	Model	Package	Description
<i>Low Input Bias (Continued)</i>			
PM108S	5962R9863701VGA	6-lead can	Low input current operational amplifier
	5962R9863701VHA	10-lead FP	
	5962R9863701VPA	8-lead DIP	
	PM1080000C PM108R000C	Class K die Class K die	
PM155S	5962R9863601VGA 5962R9863601VPA	6-lead can 8-lead DIP	Monolithic JFET input operational amplifier
PM156S	5962R9863602VGA 5962R9863602VPA	6-lead can 8-lead DIP	Monolithic JFET input operational amplifier

Aerospace Qualified Products—High Speed Op Amps

Part Number	Model	Package	Description
<i>Low Noise</i>			
OP467S	5962-9325801VCA	14-lead FP	Quad, high speed, precision op amp
	5962-9325801V2A	20-lead LCC	
	5962R9325801VDA	14-lead FP	
	5962R9325801VCA	14-lead DIP	
OP470S	5962-8856501V2A	20-lead LCC	Very low noise, quad op amp
	5962-8856501VCA	14-lead FP	
	5962R8856501V2A	20-lead LCC	
	5962R8856501VKA	24-lead FP	
	5962R8856501VCA	14-lead DIP	
	OP470-000C OP470R000C	Class K die Class K die	
OP471S	5962-8856502VCA	14-lead DIP	High speed, low noise, quad op amp
	5962R8856502VDA	14-lead FP	
	5962R8856502VKA	24-lead FP	
	5962R8856502VCA	14-lead FP	
<i>Wide Bandwidth</i>			
AD8001S	5962-9459301VPA	8-lead DIP	800 MHz, 50 mW current feedback amplifier
	5962-9459301VHA	10-lead FP	
	5962R9459301VPA	8-lead DIP	
	5962R9459301VHA	10-lead FP	
AD8041S	5962R9683902VPA 5962R9683902VHA AD8041-000C	8-lead DIP 10-lead FP Class K die	160 MHz rail-to-rail amplifier with disable
<i>Differential</i>			
AD8138S	5962R092001VHA	10-lead FP	320 MHz, low distortion differential amplifier

Amplifier and Standard Linear Products for Special Applications

High-Temperature Products

For applications that require signal processing solutions that can operate beyond 125°C, such as engineering designs in oil and gas exploration, geothermal monitoring, and industrial engine control, ADI offers products characterized at elevated temperatures.

ADR225: High Temperature, Low Drift, Micropower 2.5 V Reference

Features

- -40°C to +175°C and -40°C to +210°C packages
- High output current 10 mA
- Low dropout voltage
- Temperature coefficient
 - 30ppm/°C, 8-lead Flatpack
 - 10ppm/°C, 8-lead SOIC

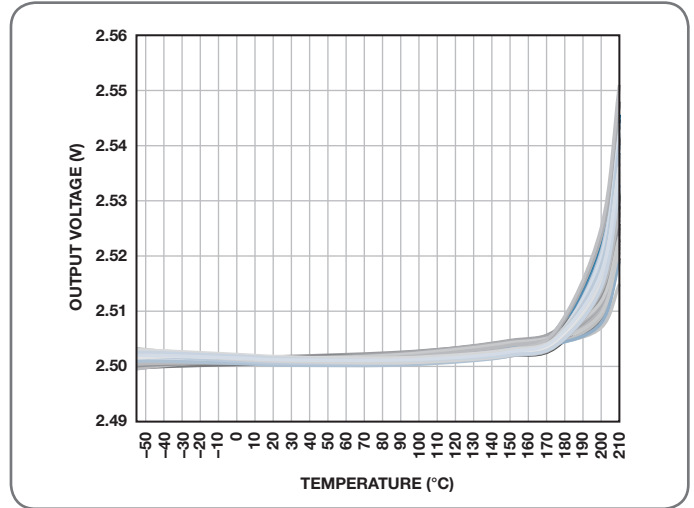

Output voltage (V_{OUT}) vs. temperature, FLATPACK package

AD8634: High Temperature, Low Power Operational Amplifier

Features

- -40°C to +175°C and -40°C to +210°C packages
- Rail-to-rail output
- Gain bandwidth product: 9.7 MHz
- Flexible power supplies: 3 V to 7 V (LFCSP)
- Low power: 1.3 mA maximum

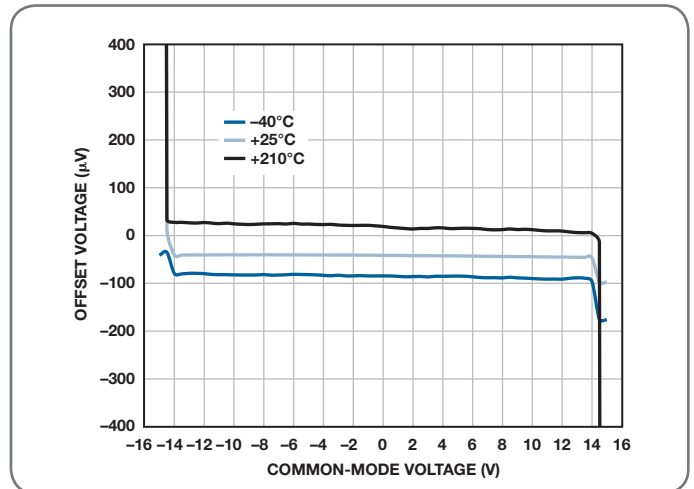

Offset voltage vs. common-mode voltage and temperature, $V_{SY} = \pm 15.0\text{ V}$

AD8229: High Temperature, Low Noise Instrumentation Amplifier

Features

- Guaranteed specifications for -40°C to +210°C
- Low noise: 1 nV/ $\sqrt{\text{Hz}}$
- Low distortion: -130 dBc at 1 kHz, $G = 1$
- Operates from $\pm 4\text{ V}$ to $\pm 17\text{ V}$ supplies

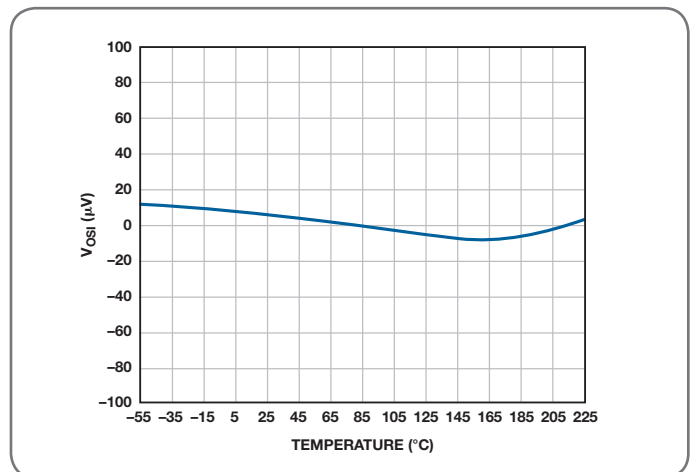

Typical input offset vs. temperature ($G = 100$)

Amplifier and Standard Linear Products for Special Applications

Enhanced Products

Analog Devices is committed to meeting the packaging needs of our customers with advancements including Enhanced Products (Products available with temperature ratings of -40°C to $+105^{\circ}\text{C}$ and -55°C to $+125^{\circ}\text{C}$) and NiPdAu lead finish products.

Amplifier and Standard Linear Enhanced Products Selection Table

Generic Part Number	Description	EP FG Model	Lead Count	Package	Lead Finished
AD712	Dual precision, low cost, high speed BiFET op amp	AD712TRZ-EP-R7	8	SOIC_N	NiPdAu
AD8039	Low power, 350 MHz voltage feedback amplifier	AD8039SARZ-EPR7	8	SOIC_N	NiPdAu
AD8138	Low distortion differential ADC driver	AD8138SRMZ-EP-R7	8	Mini_SO	NiPdAu
AD822	Single-supply, rail-to-rail, low power FET-input op amp	AD822TRZ-EP-R7	8	SOIC_N	NiPdAu
AD8231	Zero-drift, digitally programmable instrumentation amp	AD8231TCPZ-EP-R7	16	LFCSP	NiPdAu
AD8421	3 nV/ $\sqrt{\text{Hz}}$ noise precision instrumentation amp	AD8421TRMZ-EP	8	Mini_SO	NiPdAu
AD8574	Quad, zero-drift, single-supply, rail-to-rail input/output op amp	AD8574TRU-EP-RL	14	TSSOP	SnPb
AD8643	Quad, low power, rail-to-rail output, precision JFET op amp	AD8643TRZ-EP-R7	14	SOIC_N	NiPdAu
ADA4897-1	Single, 1 nV/ $\sqrt{\text{Hz}}$, low power, rail-to-rail output op amp	ADA4897-1SRJZ-EPR7	6	SOT23	NiPdAu
ADA4897-2	Dual, 1 nV/ $\sqrt{\text{Hz}}$, low power, rail-to-rail output op amp	ADA4897-2TRMZ-EP	8	Mini_SO	NiPdAu
ADA4930-1	Ultralow distortion, low voltage ADC driver	ADA4930-1SCPZ-EPRL	16	LFCSP	NiPdAu
ADR01	Ultracompact, precision 10.0 V voltage reference	ADR01TUJZ-EP-R7	5	TSOT	NiPdAu
ADR293	Low noise, micropower 5.0 V precision voltage reference	ADR293TRU-EP-R7	8	TSSOP	SnPb
ADR431	Ultralow noise XFET [®] 2.5 V voltage reference with current sink and source capability	ADR431TRZ-EP-R7	8	SOIC_N	NiPdAu
ADR434	Ultralow noise XFET 4.096 V voltage reference with current sink and source capability	ADR434TRZ-EP-R7	8	SOIC_N	NiPdAu
ADR435	Ultralow noise XFET 5.0 V voltage reference with current sink and source capability	ADR435TRZ-EP-R7	8	SOIC_N	NiPdAu
OP262	Dual, 15 MHz rail-to-rail op amp	OP262TRZ-EP-R7	8	SOIC_N	NiPdAu

Amplifier and Standard Linear Products for Special Applications

Die Products

Bare die products provide design benefits for some applications including board space reduction, temperature rating maximization, ruggedness improvement, and more. Analog Devices offers a wide precision linear portfolio for its die program, which extends to automotive, military and aerospace, and other commercial applications. All die are 100% electrically tested and ADI provides full quality, reliability, failure analysis, and applications support for all products.

Amplifier and Standard Linear Die Products Selection Guide

Model Number	Description	Die Size	Bond Pad Metalization	Packaging
<i>Automotive Grade</i>				
AD8202WYC-P3	High common-mode voltage difference amp	47 × 46	AlCu	Reel
AD8202WYC-P7	High common-mode voltage difference amp	47 × 46	AlCu	Reel
AD8210WYC-P3	High speed bidirectional current shunt amp	60 × 50	AlCu	Reel
AD8694WAC-P3	Low noise CMOS op amp	57 × 53	AlCu	Reel
AD8694WAC-P7	Low noise CMOS op amp	57 × 53	AlCu	Reel
<i>Commercial Grade</i>				
AD532JCHIPS	Multiplier IC	116 × 70	AlCu	Waffle pack
AD534KCHIPS	Multiplier IC	80 × 102	AlCu	Waffle pack
AD536ASCHIPS	RMS/DC converter IC	83 × 135	AlCu	Waffle pack
AD538ACHIPS	Multiplier	194 × 129	AlCu	Waffle pack
AD596ACHIPS	Thermocouple chip	90 × 58	AlCu	Waffle pack
AD603ACHIPS	Variable gain op amp	72 × 93	AlCu	Waffle pack
AD605ACHIPS	Low noise, dual-channel VGA	70 × 117	AlCu	Waffle pack
AD620ACHIPS	Low Power Instrumentation Amp	61 × 109	AlCu	Waffle pack
AD624ACHIPS	Low noise, precision instrumentation amp	103 × 171	AlCu	Waffle pack
AD629AC-WP	High common-mode voltage difference amp	97 × 65	AlCu	Waffle pack
AD744JCHIPS	High speed BiFET op amp	63 × 63	AlCu	Waffle pack
AD8001ACHIPS	High performance, low power video amp	38 × 41	AlCu	Waffle pack
AD8003ACHIPS	1.4 GHz op amp with disable chip	76 × 41	AlCu	Waffle pack
AD8009ACHIPS	1 GHz, 5500 V/mS, low distortion amp	37 × 40	AlCu	Waffle pack
AD8013ACHIPS	Triple, low power video op amp	48 × 74	AlCu	Waffle pack
AD8023ACHIPS	Triple, high output video amp	63 × 71	AlCu	Waffle pack
AD8032ACHIPS	Dual, 2.7 V, 80 MHz rail-to-rail op amp	35 × 61	AlCu	Waffle pack
AD8034ACHIPS	Dual, 85 MHz FET input amp	31 × 76	AlCu	Waffle pack
AD8036ACHIPS	240 MHz, clamped amp gain = 1	41 × 45	AlCu	Waffle pack
AD8037ACHIPS	350 MHz, clamped amp gain = 2	47 × 51	AlCu	Waffle pack
AD8042ACHIPS	Dual, 160 MHz rail-to-rail amp	46 × 65	AlCu	Waffle pack
AD8057ACHIPS	Single, low cost, 350 MHz op amp	32 × 37	AlCu	Waffle pack
AD8058ACHIPS	Dual, low cost, 350 MHz op amp	40 × 45	AlCu	Waffle pack
AD810ACHIPS	High speed, video op amp with disable	62 × 94	AlCu	Waffle pack
AD811ACHIPS	High performance, video op amp	62 × 98	AlCu	Waffle pack
AD813ACHIPS	Triple, low power, video op amp	57 × 124	AlCu	Waffle pack
AD8138ACHIPS	500 MHz, low distortion difference op amp	44 × 45	AlCu	Waffle pack
AD822C-WP	Dual, single-supply, precision amp	71 × 91	AlCu	Waffle pack
AD822-012C	Dual, single-supply, precision amp	66 × 128	AlCu	Waffle pack
AD8221AC-P7	Single, 30 V/36 V instrumentation amp	88 × 62	AlCu	Reel
AD825ACHIPS	High speed, FET input op amp	42 × 69	AlCu	Waffle pack
AD827JCHIPS	Dual, high speed, low power op amp	54 × 125	AlCu	Waffle pack
AD829JCHIPS	High speed, low noise video op amp	54 × 67	AlCu	Waffle pack
AD841JCHIPS	Wideband, unity-gain stable op amp	67 × 99	AlCu	Waffle pack
AD843JCHIPS	35 MHz, CBFET, high speed op amp	67 × 102	AlCu	Waffle pack
AD844ACHIPS	60 MHz, 2000 V/mms wideband op amp	77 × 96	AlCu	Waffle pack
AD845JCHIPS	Precision, 16 MHz, CBFET, high speed op amp	57 × 112	AlCu	Waffle pack
AD847JCHIPS	High speed, low power, monolithic op amp	54 × 67	AlCu	Waffle pack
AD848JCHIPS	High speed, low power, monolithic, 5 stable op amp	54 × 67	AlCu	Waffle pack
AD9631ACHIPS	350 MHz, unity-gain op amp	47 × 51	AlCu	Waffle pack
ADR01-001C	10 V, precision band gap reference	33 × 41	AlCu	Waffle pack
ADR02ACHIPS	5 V, precision band gap reference	33 × 41	AlCu	Waffle pack
AMP01NBC	Low noise, bipolar precision instrumentation amp	116 × 149	AlCu	Waffle pack
AMP04GBC	Unity-gain, low power, bipolar instrumentation amp	79 × 99	AlCu	Waffle pack
OP27NBC	Low noise, precision, bipolar op amp	66 × 95	AlCu	Waffle pack
OP37NBC	Low noise, precision, high speed op amp	70 × 95	AlCu	Waffle pack
OP400GBC	Quad, low power, low offset, bipolar op amp	123 × 181	AlCu	Waffle pack
OP42NBC	High speed, fast settling, precision op amp	74 × 97	AlCu	Waffle pack
OP467GBC	Quad, precision, high speed, low noise op amp	112 × 123	AlCu	Waffle pack
OP77NBC	Ultralow offset voltage, precision op amp	57 × 93	AlCu	Waffle pack
REF43NBC	Precision, low power, 2.5 V reference	65 × 84	AlCu	Waffle pack

Amplifier and Standard Linear Die Products Selection Guide (continued)

Model Number	Description	Die Size	Bond Pad Metalization	Packaging
<i>Known Good Die Grade</i>				
AD8028-KGD-CHIP	Dual, high speed rail-to-rail input/output amp	59 × 54	AlCu	Waffle pack
AD8065-KGD-CHIP	Single, 135 MHz, low noise, FET input amp	34 × 47	AlCu	Waffle pack
ADA4897-2-KGD	1 nV/√Hz, low power op amp	56 × 48	AlCu	Waffle pack
AD8202W-KGD-R7	High common-mode voltage difference amp	46 × 46	AlCu	Reel
AD8229-KGD-CHIPS	Ultralow noise, 210°C, instrumentation amp	69 × 114	AlCu	Waffle pack
<i>High Temperature Grade</i>				
AD8634-KGD	High temperature, dual, rail-to-rail amp	52 × 44	AlSiCu	Waffle pack
ADR225-KGD	High temperature, precision 2.5 V reference	39 × 56	AlCu	Waffle pack
<i>Military/Aerospace Grade</i>				
AD524SCHIPS	Precision, low noise instrumentation amp	103 × 171	AlCu	Waffle pack
AD532SCHIPS	Multiplier IC	70 × 116	AlCu	Waffle pack
AD534SCHIPS	Multiplier IC	80 × 102	AlCu	Waffle pack
AD534TCHIPS	Multiplier IC	80 × 102	AlCu	Waffle pack
AD580TCHIPS	2.5 V reference	46 × 75	AlCu	Waffle pack
AD584TCHIPS	Programmable 10 V reference	63 × 89	AlCu	Waffle pack
AD624SCHIPS	Low noise, precision instrumentation amp	103 × 171	AlCu	Waffle pack
AD630SCHIPS	Modulator/demodulator VGA	89 × 99	AlCu	Waffle pack
AD734SCHIPS	Multiplier IC	93 × 22	AlCu	Waffle pack
AD746SCHIPS	Dual, precision, biFET op amp	70 × 110	AlCu	Waffle pack
AD811SCHIPS	High performance, video op amp	62 × 98	AlCu	Waffle pack
AD827SCHIPS	Dual, high speed, low power op amp	54 × 125	AlCu	Waffle pack
AD829SCHIPS	High speed, low noise, video op amp	54 × 67	AlCu	Waffle pack
AD841SCHIPS	Wideband, unity-gain stable op amp	67 × 99	AlCu	Waffle pack
AD842SCHIPS	Wideband, high speed op amp	67 × 106	AlCu	Waffle pack
AD843SCHIPS	36 MHz CBFET high speed op amp	67 × 102	AlCu	Waffle pack
AD844SCHIPS	61 MHz, 2000 V/mms wideband op amp	77 × 96	AlCu	Waffle pack
AD847SCHIPS	High speed, low power, monolithic op amp	54 × 67	AlCu	Waffle pack
AD848SCHIPS	High speed, low power, monolithic 5 stable op amp	54 × 67	AlCu	Waffle pack

Design Resources

Evaluation Board

Analog Devices provide a variety of amplifier evaluation boards:

- Precision operational amplifier evaluation boards: Analog Devices offers universal precision op amp evaluation boards that are designed and optimized for many circuit configurations allowing the users to best suit their applications. These boards are all RoHs compliant.
- Precision instrumentation amplifiers evaluation boards: Analog Devices provides a line of evaluation boards designed to help users evaluate our instrumentation amplifiers in 8-pin packages: AD62x, AD822x, and AD842x series. User guide UG-261 describes three generic evaluation boards that can be used to evaluate many Analog Devices instrumentation amplifiers. For other instrumentation amplifiers, evaluation boards are available to order on their respective product pages.
- High speed operational amplifier evaluation boards: Analog Devices provide universal evaluation boards for different packaging configurations. Follow the ordering guide on each product page to order high speed op amp evaluation boards. All evaluation boards are “bare,” therefore, it is necessary to order the simplifier and the evaluation board.

SPICE Models

Analog Devices supplies SPICE models that closely duplicate data sheet test measurements. Each SPICE model can be found on the amplifier product page. SPICE models can also be found in National Instruments Multisim, as well as many other circuit simulators.

Circuits from the Lab® Reference Designs

These signal chain designs are commonly used as standalone solutions, or to build more complex, circuits, and subsystems.

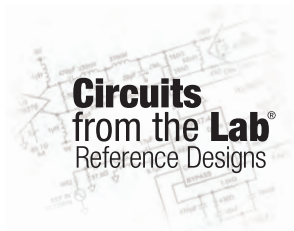

Built and tested for function and performance by ADI's application experts, they offer:

- Comprehensive documentation
- Complete design and integration files
- Factory-tested evaluation hardware

Visit www.analog.com/CircuitsfromtheLab

EngineerZone Support Community



EngineerZone is an online support community for engineers who are using Analog Devices amplifier products to ask questions, share knowledge and search for answers to their design questions. Collaborate with Analog Devices engineers and other designers in this open forum at ez.analog.com

Tools for Evaluating and Selecting ADI Precision Linear Parts

Analog Filter Wizard

The Analog Filter Wizard™ simplifies and speeds up the process of active filter design. The intuitive user interface, well-written help and tutorials provide easy-to-follow guidance for the op amp choice. Visit www.analog.com/filterwizard

Features and Benefits

- Web-based tool with client side modeling enables fast execution speed.
- Extensive built-in op amp models and filter circuits provide actual op amp choice for low-pass, high-pass, or band-pass filter designs.
- Simulates filter performance in real time and provides multiple views including resistor and capacitor tolerances effect.
- Recommends op amp and passive components per user's design to optimize power, noise performance, or voltage range. Alternatively, users can specify op amps and adjust components manually.
- Users can save, share, get design files, or order evaluation board for final results.

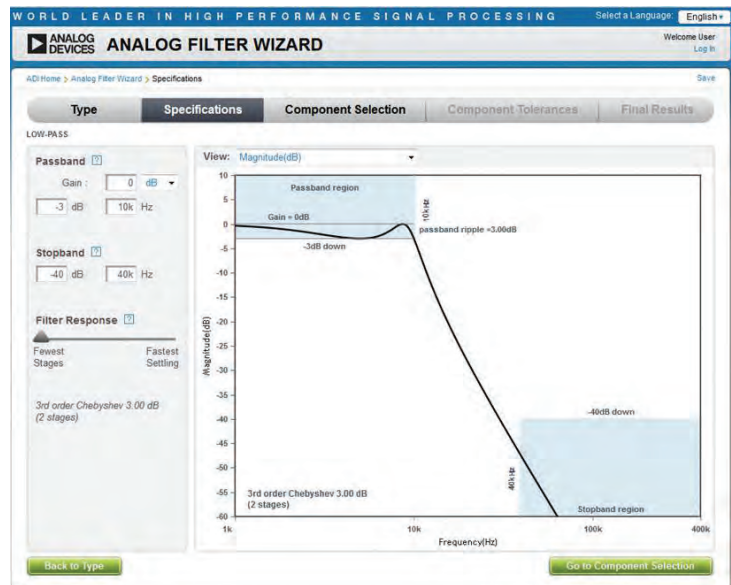

Photodiode Wizard

The Photodiode Wizard speeds up the process of selecting and designing the best circuit for your particular photodiode application. Visit www.analog.com/photodiode

Features and Benefits

- Clean user-interface with extended help/tutorial system simplifies the design process.
- Web-based operation enables fast responsive time with immediate visual feedback.
- Tool provides intelligent selection for “best fit” op amp. Alternatively, users can select from a library of amplifiers. (Tool will group op amps in “recommended,” “not recommended,” and “not allowed” per input specifications and provides reasons for the latter two categories.)
- Simulation results are displayed graphically for step response, frequency response, noise gain, and stability with performance of user-chosen op amp modeled in these graphs.
- Noise performance is shown when designing circuits. SNR and ENOB are visible in “Quick Results” section with SNR tab lists components contributing to the noise.

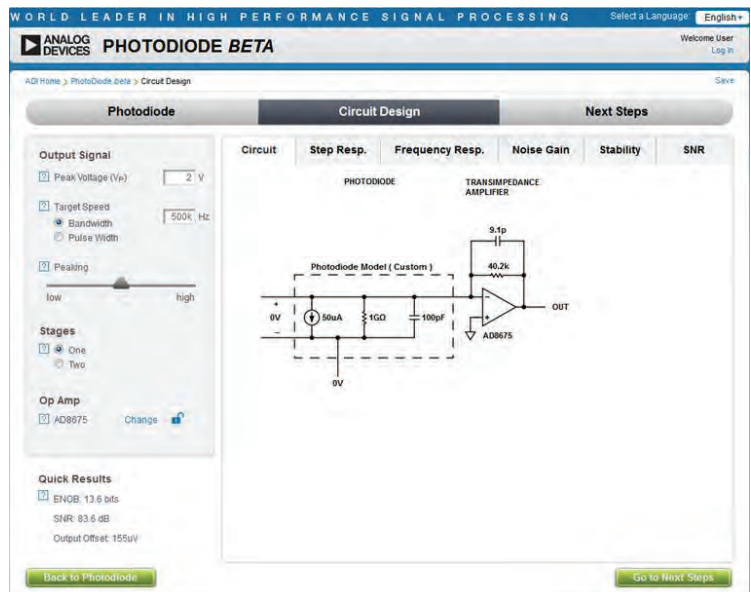

Signal Chain Designer

Signal Chain Designer is an advanced product selection and recommendation toolset. It brings together a powerful search engine, verified product recommendations, tested application circuits, integrated Analog Filter Wizard and Photodiode Wizard, and connects to other Analog Devices engineering tools to provide an easy to use, one stop circuit builder for design engineers. For more information, visit: www.analog.com/SignalChainDesigner

What You Can Expect from Signal Chain Designer Beta:

- Quickly search and confidently select components to build customized signal chains
- Access over 200 tested application circuits and verified product combinations
- Use integrated design tools to further optimize signal chain components
- Download complete design package including custom BOM, documentation, schematics, and Gerber files
- Easily share your designs and order parts or evaluation boards

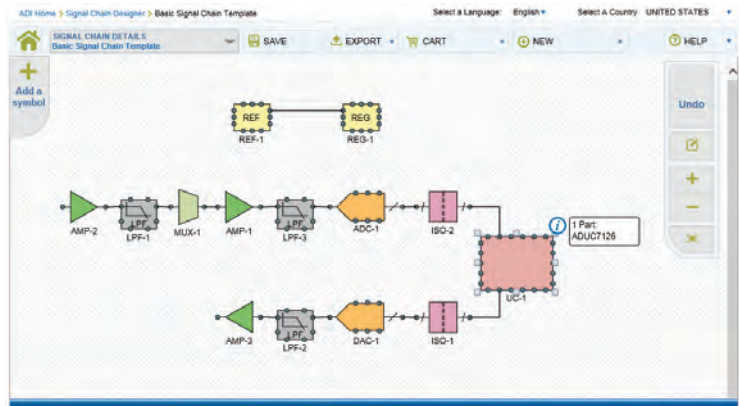

ADI DiffAmpCalc

ADI DiffAmpCalc™ performs all the required differential amplifier calculations, which reduces design risks and further speeds time to market. In addition, designers can quickly and easily calculate gain and component values of a differential amplifier circuit for terminated or unterminated loads, determine the input/output and V_{OCM} voltage range, as well as calculate noise and power dissipation. The tool also prevents you from making mistakes by alerting you when a device parameter has been exceeded. Visit www.analog.com/diffampcalc.

Features and Benefits

- Automate time consuming calculations required to determine optimal levels for gain, termination resistors, power dissipation, noise output, and input common-mode voltage range
- Create unlimited “what if” scenarios as data changes appear in real time
- Intuitive GUI features an interactive dashboard
- Use a “point and click” method for quickly and easily adding and changing data
- Supports ADI’s differential amplifier products including ADA4927, ADA4932, ADA4937, ADA4938, ADA4939, AD8132, AD8137, AD8138, AD8139, and ADA4930

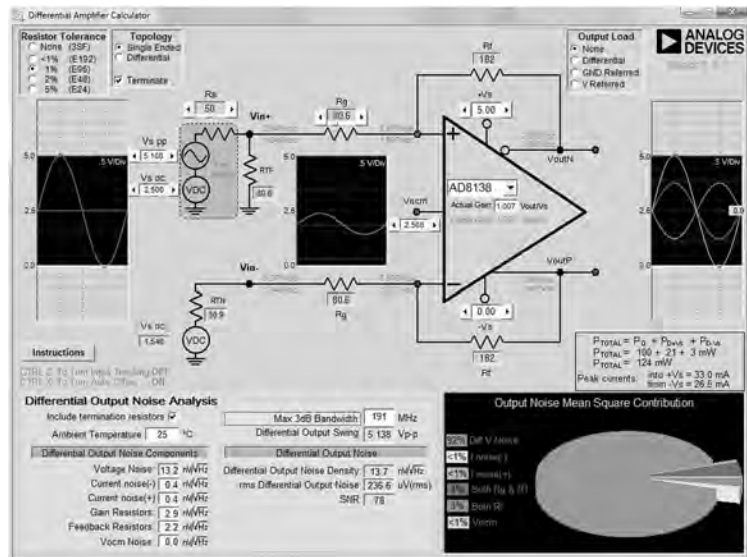

Op Amp Stability for Capacitive Loads

Driving capacitive loads can be challenging for op amps. Stability, bandwidth, and settling time are all concerns when capacitive loads are involved. This tool helps prevent and remedy any potential issues that might arise when driving capacitive loads. This tool is Web-based. Visit www.analog.com/opamp_stability.

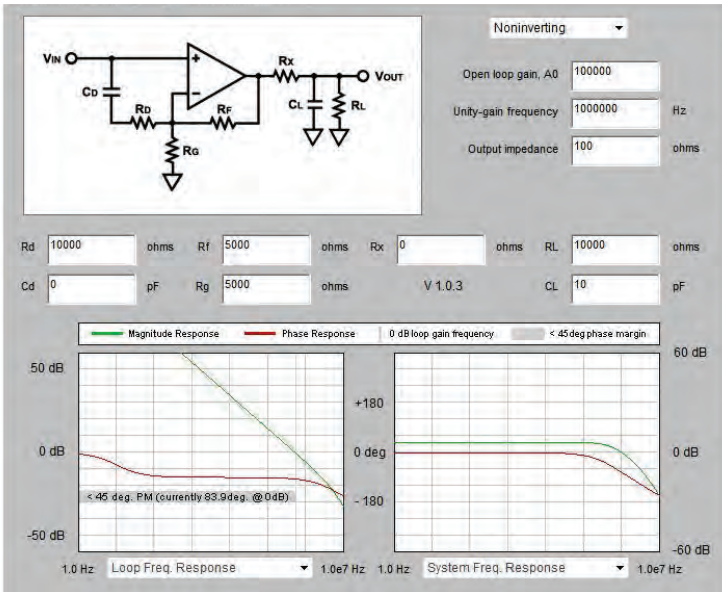

Vrms/dBm/dBu/dBV Calculator

A utility to convert between standard units of power measurement and signal strength, this calculator converts between dBm, dBu, dBV, V_{PEAK} , and Vrms (ANSI T1.523-2001 definitions). dBm is a power ratio relative to 1 mW, dBu and dBV are voltage ratios, relative to 0.775 V and 1 V, respectively. Visit www.analog.com/vrms_dbm_dbu_dbv_calculator.

[Instructions](#) | [Troubleshooting](#)

Application data

Z_D : 50 ohms

Waveform: Sine Wave

Convert

V_{PEAK} : 1 V

V_{RMS} : 0.7071 V

Power: 10 mW

dBm: 10 dBm

dBu: -0.7918 dBu

dBV: -3.01 dBV

Voltage gain =

10 V/V

20 dB

2.303 Np

Calculate

v09.3

Power Dissipation vs. Die Temperature Calculator

This is a calculator for estimating junction temperature from power dissipation and packaging/heatsink characteristics. It computes die power dissipation and temperature for a linearly regulated output from quantities specified under "Parameters." It also computes power dissipated in an external load. Visit www.analog.com/powerdis_vs_dietempcalculator.

[Instructions](#) | [Troubleshooting](#)

Parameters			
T_A	Ambient temp. <input type="text" value="70"/> °C	T_J	Die junction temp. 77.53 °C
V_+	Pos. supply <input type="text" value="+15"/> V	P_{DIE}	Die power dissipation 0.14 W
V_-	Neg. supply <input type="text" value="-15"/> V	P_{LOAD}	Load power 0.01 W
I_Q	Quiescent curr. <input type="text" value="0"/> mA		
V_{OUT}	Load voltage <input type="text" value="1"/> V		
R_L	Load resistance <input type="text" value="100"/> ohms		
V_{GND}	Load ground <input type="text" value="0"/> V		
Theta _{JA} Theta <input type="text" value="53.8"/> °C / W			
<input type="button" value="Calculate"/>			
V 0.9.6			

ADIsimOpAmp

This tool helps with the selection, evaluation and troubleshooting of voltage feedback op amps. It allows a user to select an amplifier, configure a circuit, apply a signal and, evaluate the performance. It is useful for checking an amplifier's specs such as bandwidth, slew rate, input/output range, gain error, load current, stability issues, and dc errors in a given circuit. Visit: www.analog.com/adisimopamp.

Design Tools: ADIsimOpAmp (Amplifier Parametric Evaluation Tool)

[Instructions](#) | [Glossary](#) | [Error Messages](#) | [Submit Feedback](#)

Please Select an Amplifier
Amplifier Selection Tools: (Help)
Enter Part Number | Parametric Search | Selection Wizard | Suggest Amplifier

Powered by 

Select Mode: Inverting Non-inverting Difference

Enter values: (these are default values)

R _{BIAS} : <input type="text" value="0"/> Ω	R _{BIAS} : <input type="text" value="1"/> Ω
R _C : <input type="text" value="1"/> Ω	R _{SERIES} : <input type="text" value="0"/> Ω
R _{FB} : <input type="text" value="1"/> Ω	C _L : <input type="text" value="0"/> nF
V _S : <input type="text" value="5"/> V	R _L : <input type="text" value="100"/> Ω
-V _S : <input type="text" value="-5"/> V	
V _{REF} : <input type="text" value="0"/> V	

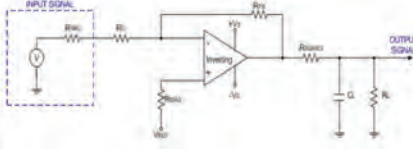

Input Signal



Output Signal



Select Waveform: Sine Triangle DC

Enter values:

Amplitude: V_{pk}

Frequency: Hz

DC Offset: V

Note: This tool uses typical values. Find out how this tool does calculations.

Gain Error: Excluded Included Gain:

DC Errors: Excluded Include Positive Errors Include Negative Errors

Output Voltage: V_(p-p): V_(RMS): V_(DC):

Log

Please Select an Amplifier
Amplifier Selection Tools: (Help)
Enter Part Number | Parametric Search | Selection Wizard | Suggest Amplifier

In-Amp Error Budget Calculator

This calculator helps estimate error contributions in your instrumentation amplifier circuit. Visit: www.analog.com/inamp-error-budget

Interactive Design Tools: Instrumentation Amplifiers : Inamp Error Budget Analysis

AD8225

A tool for estimating error contributions in Analog Devices instrumentation amplifiers.

Instructions | Troubleshooting

Application Parameters

Differential Amplitude, V_{DIFF} mV Common Mode Voltage, V_{CM} V

Gain Operating Temperature, T_A °C

Source Impedance R_{S+} ohms R_{S-} ohms

Error Source	Specification	Calculation	Effect on Absolute Resolution Accuracy at Temp.	Effect on Accuracy
Gain Error	<input type="text" value="0.1"/> %		<input type="text" value=""/> ppm	<input type="text" value=""/> ppm
Gain Drift, G_{TC}	<input type="text" value="5"/> ppm / °C	$G_{TC} * (T_A - 25)$	<input type="text" value=""/> ppm	<input type="text" value=""/> ppm
Gain Nonlinearity	<input type="text" value="0.0010"/> %		<input type="text" value=""/> ppm	<input type="text" value=""/> ppm
Input Offset Voltage, V_{OSI}	<input type="text" value="150"/> μV	V_{OSI} / V_{DIFF}	<input type="text" value=""/> ppm	<input type="text" value=""/> ppm
Input Offset Voltage Drift, V_{OSI_TC}	<input type="text" value="2"/> μV / °C	$(V_{OSI_TC} / V_{DIFF}) * (T_A - 25)$	<input type="text" value=""/> ppm	<input type="text" value=""/> ppm
Output Offset Voltage, V_{OSO}	<input type="text" value="00"/> mV	$V_{OSO} / (GAIN * V_{DIFF})$	<input type="text" value=""/> ppm	<input type="text" value=""/> ppm
Output Offset Voltage Drift, V_{OSO_TC}	<input type="text" value="00"/> μV / °C	$(V_{OSO_TC} / (GAIN * V_{DIFF})) * (T_A - 25)$	<input type="text" value=""/> ppm	<input type="text" value=""/> ppm
Bias Current, I_B	<input type="text" value="1.2"/> nA	$I_B * (R_{S+} + R_{S-}) / V_{DIFF}$	<input type="text" value=""/> ppm	<input type="text" value=""/> ppm
- Source Imbalance Error				
Bias Current Drift, I_{B_TC}	<input type="text" value="3.0"/> pA / °C	$I_{B_TC} * (R_{S+} + R_{S-}) * (T_A - 25) / V_{DIFF}$	<input type="text" value=""/> ppm	<input type="text" value=""/> ppm
- Source Imbalance Drift				
Offset Current, I_{OS}	<input type="text" value="0.5"/> nA	$I_{OS} * MAX(R_{S+}, R_{S-}) / V_{DIFF}$	<input type="text" value=""/> ppm	<input type="text" value=""/> ppm
- Source Resistance + Imbalance Error				
Offset Current Drift, I_{OS_TC}	<input type="text" value="1.5"/> pA / °C	$I_{OS_TC} * MAX(R_{S+}, R_{S-}) * (T_A - 25) / V_{DIFF}$	<input type="text" value=""/> ppm	<input type="text" value=""/> ppm
- Source Resistance + Imbalance Drift				
Common Mode Rejection, CMRR	<input type="text" value="80"/> dB	$V_{CM} / (10^{CMRR/20} * V_{DIFF})$	<input type="text" value=""/> ppm	<input type="text" value=""/> ppm
Noise, RTI (0.1 Hz - 10 Hz)	<input type="text" value="1.5"/> μVp-p		<input type="text" value=""/> ppm	<input type="text" value=""/> ppm
TOTALS			<input type="text" value=""/> ppm	<input type="text" value=""/> ppm

V 1.0.6 CPP3

In-Amp Common-Mode Calculator

The tool calculates the common-mode gain for instrumentation amplifiers using gain, differential voltage, and various other input parameters. It calculates both the internal node voltages and the output voltage of the part. It also calculates the resistor needed for a particular gain or the resulting gain using a certain resistor.

Interactive Design Tools: Instrumentation Amplifiers : Inamp Common-Mode Range / Gain Calculator

AD8422

An online tool to select a value for R_G and determine the maximum differential and common mode voltages allowable.

Instructions | Troubleshooting | Related Information

Positive Supply V

Differential Voltage V_{IN-} V Gain

Common Mode Voltage V_{IN+} V R_G k ohms

Reference Voltage V

Negative Supply V

Equivalent circuit shown
V 1.0.10 / 1.0.10

Voltage Reference Selection and Evaluation Wizard

This tool uses step by step approach to help you find the best voltage reference for your application based on design parameters and estimate its output based on various error sources. Visit: www.analog.com/verf-wizard

This tool helps find the best voltage reference for your application based on design parameters and estimate its output based on various error sources. To search voltage references by additional product parameters, try the [parametric search](#). Also, if you'd like to work offline, try our [downloadable version of the Reference Wizard](#).

Voltage Reference Selection Wizard
Voltage Reference Evaluator

You are currently using the **Voltage Reference Selection Wizard** portion of the tool. Enter your design parameters below and click **Find Parts**. A list of suitable references will be displayed in the table below. Click on the **Evaluate** button within the table to launch the **Voltage Reference Evaluator**.

STEP 1: Enter Input Parameters

Desired Output Voltage (nominal):

Input Voltage (max): V
For a desired output voltage of 5V, input voltage must be between -15 and 40V.

Error Budget: total ppm mV %
Allowable drift range: 5V ± 25.00mV (±0.50%)

Operating Temperature Range: - °C

STEP 2: Browse Suggested References, Evaluate

*The table shows parts which meet the input parameters above. The 'Estimated Vout Drift' is calculated using the initial accuracy, temperature coefficient and output noise. To perform a deeper error budget analysis with more parameters, click the **evaluate** button within the table.*

Search Results: Found 37 part(s) which meet the input criteria. Found an additional 5 close part(s) which are highlighted in red within the table.

Part Number	Vout (V)	Estimated Vout Drift (%)	V _{IN} Min (V)	V _{IN} Max (V)	Initial Accuracy (%)	Temp Coeff (ppm/°C)	Package	Further evaluate this part
ADR445BRZ	5	0.0700	5.5000	18	0.0400	3	SOIC-8	<input type="button" value="Evaluate"/>
ADR425BRZ	5	0.0700	7	18	0.0400	3	SOIC-8	<input type="button" value="Evaluate"/>
ADR425BR	5	0.0700	7	18	0.0400	3	SOIC-8	<input type="button" value="Evaluate"/>

Design Equations—Commonly Used Amplifier Configurations

Voltage Follower

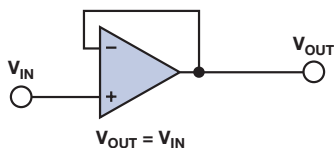

$V_{OUT} = V_{IN}$

**BUFFER HIGH IMPEDANCE SOURCE
TO LOW RESISTANCE LOAD**

Noninverting Op Amp

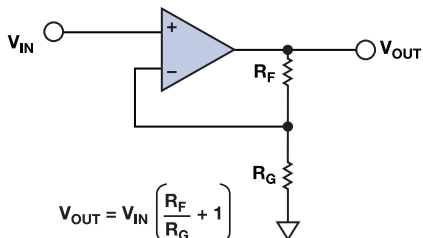

$V_{OUT} = V_{IN} \left(\frac{R_F}{R_G} + 1 \right)$

IN-PHASE SIGNAL AMPLIFICATION

Inverting Op Amp

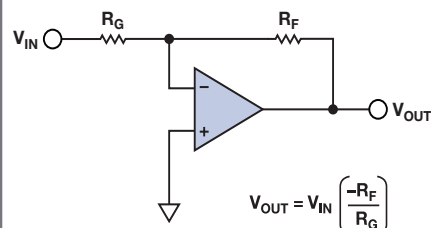

$V_{OUT} = V_{IN} \left(\frac{-R_F}{R_G} \right)$

AMPLIFY AND INVERT INPUT

Voltage Subtractor/ Difference Amplifier

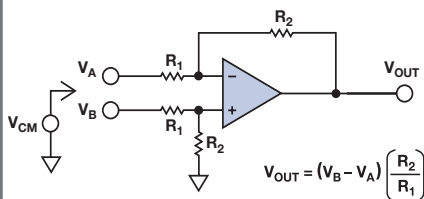

$V_{OUT} = (V_B - V_A) \left(\frac{R_2}{R_1} \right)$

**AMPLIFY THE DIFFERENCE
BETWEEN TWO VOLTAGES,
REJECT COMMON-MODE VOLTAGE**

Voltage Adder

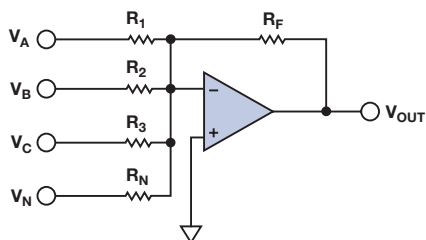

$V_{OUT} = \left(\frac{V_A}{R_1} + \frac{V_B}{R_2} + \frac{V_C}{R_3} + \frac{V_N}{R_N} \right) (-R_F)$

SUM MULTIPLE VOLTAGES

Low-Pass Filter/Integrator

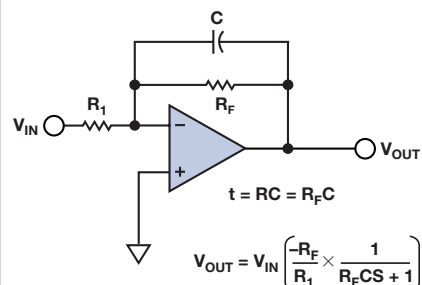

$t = RC = R_F C$

$V_{OUT} = V_{IN} \left(\frac{-R_F}{R_1} \times \frac{1}{R_F C S + 1} \right)$

LIMIT BANDWIDTH OF SIGNAL

High-Pass Filter/Differentiator

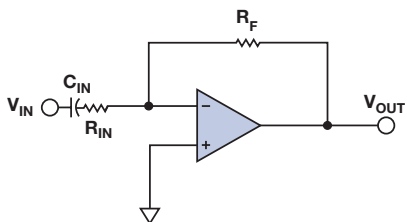

$V_{OUT} = V_{IN} \left(\frac{-R_F}{R_{IN}} \times \frac{R_{IN} C_{IN} S}{R_{IN} C_{IN} S + 1} \right)$

BLOCK DC, AMPLIFY AC

Differential Amplifier

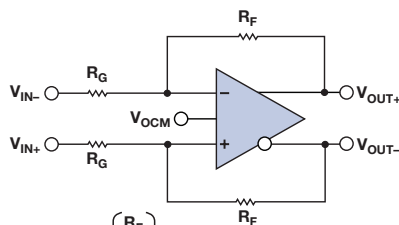

$V_{OUT_{diff}} = \left(\frac{R_F}{R_G} \right) V_{IN}$

$V_{OUT_{cm}} = V_{OCM}$

**DRIVE A DIFFERENTIAL INPUT ADC FROM A
DIFFERENTIAL OR SINGLE-ENDED SOURCE**

Instrumentation Amplifier

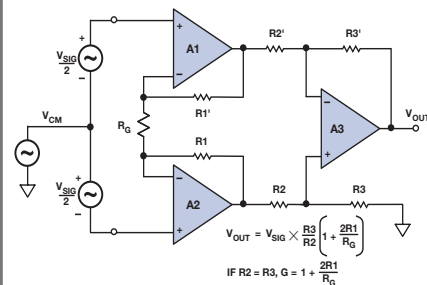

$V_{OUT} = V_{SIG} \times \frac{R_3}{R_2} \left(1 + \frac{2R_1}{R_G} \right)$

IF $R_2 = R_3, G = 1 + \frac{2R_1}{R_G}$

**AMPLIFY LOW LEVEL DIFFERENTIAL SIGNAL,
REJECT COMMON-MODE SIGNAL**

Op Amp Noise for Single-Pole System

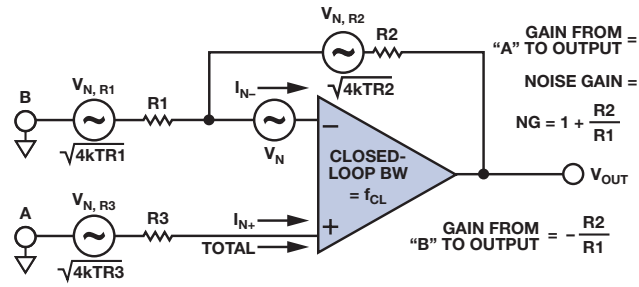

GAIN FROM "A" TO OUTPUT = $1 + \frac{R2}{R1}$
 NOISE GAIN = $NG = 1 + \frac{R2}{R1}$
 GAIN FROM "B" TO OUTPUT = $-\frac{R2}{R1}$

$$RTI \text{ NOISE} = \sqrt{BW} \times \sqrt{V_N^2 + 4kTR3 + 4kTR1 \left(\frac{R2}{R1 + R2}\right)^2 + I_{N+}^2 R3^2 + I_{N-}^2 \left(\frac{R1 \times R2}{R1 + R2}\right)^2 + 4kTR2 \left(\frac{R1}{R1 + R2}\right)^2}$$

RTO NOISE = NG × RTI NOISE
 RTI = REFER TO INPUT
 RTO = REFER TO OUTPUT
 BW = 1.57 f_{CL}

Decibel (dB) Formulas (Equal Impedances)

$$db = 10 \text{ Log } \frac{P_{OUT}}{P_{IN}} = 20 \text{ Log } \frac{V_{OUT}}{V_{IN}} = 20 \text{ Log } \frac{I_{OUT}}{I_{IN}} \text{ (Gain)}$$

Sinusoidal Voltages and Currents

RMS = Root Mean Square = Effective

$$V_{RMS} = 0.707 V_{PEAK} = V_{EFF}$$

$$V_{AVE} = 0.637 V_{PEAK}$$

$$V_{EFF} = 1.11 V_{AVE}$$

$$V_{PEAK} = 1.57 V_{AVE}$$

$$V_{AVE} = 0.9 V_{EFF}$$

Resistor Johnson Noise Formula

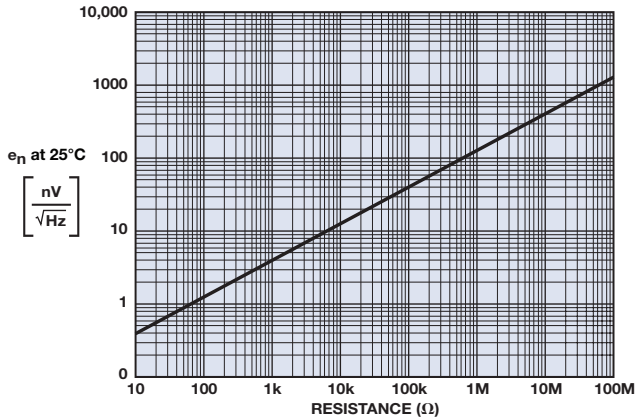

$V_R = \sqrt{4kTRB}$
 where:
 V_R = resistor Johnson Noise spectral density
 k = Boltzmann's constant (1.38×10^{-23} J/K)
 T = absolute temperature in Kelvin
 R = resistance in Ohms
 B = bandwidth in Hz

At 25°C, $4kT = 1.65 \times 10^{-20}$ W/Hz, therefore, $V_R = \sqrt{1.65 \times 10^{-20} RB}$

Ohm's Law (DC Circuits)

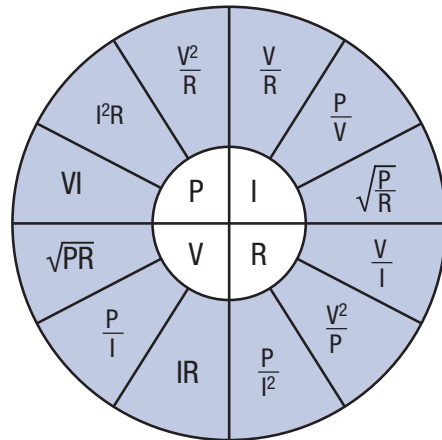

Closed-Loop Frequency Response for Voltage Feedback Amplifiers

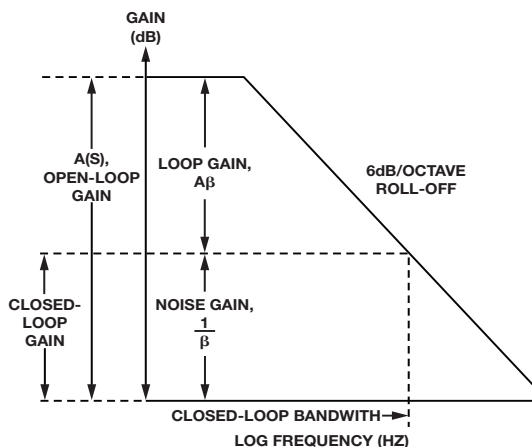

Resistors in Series/Capacitors in Parallel

$$R_{TOTAL} = R_1 + R_2 + R_3 + \dots / C_{TOTAL} = C_1 + C_2 + C_3 + \dots$$

Resistors in Parallel/Capacitors in Series

$$R_{TOTAL} = \frac{1}{\frac{1}{R_1} + \frac{1}{R_2} + \frac{1}{R_3} + \dots} / C_{TOTAL} = \frac{1}{\frac{1}{C_1} + \frac{1}{C_2} + \frac{1}{C_3} + \dots}$$

Two Resistors in Parallel

$$R_{TOTAL} = \frac{R_1 R_2}{R_1 + R_2}$$

Equal Resistors in Parallel

$$R_{TOTAL} = \frac{R}{N}$$

Where R is the value of one of the equal resistors, and N is the number of equal resistors

Reactance Formulas

$$X_C = \frac{1}{2\pi fC}$$

$$X_L = 2\pi fL$$

Impedance Formulas (Series)

$$Z = \sqrt{R^2 + X_L^2} \text{ (Series RL)}$$

$$Z = \sqrt{R^2 + X_C^2} \text{ (Series RC)}$$

$$Z = X_L - X_C \text{ (Series LC)}$$

$$Z = \sqrt{R^2 + (X_L - X_C)^2} \text{ (Series RLC)}$$

$$Z = \frac{V_A}{I}$$

Voltage and Impedance Formulas (Parallel)

$$Z = \frac{RX_L}{\sqrt{R^2 + X_L^2}} \text{ (RL)} \quad Z = \frac{V_A}{I_{LINE}}$$

$$Z = \frac{RX_C}{\sqrt{R^2 + X_C^2}} \text{ (RC)} \quad V_A = V_L = V_C = V_R$$

$$Z = \frac{X_L X_C}{X_L - X_C} \text{ (LC)} \quad V_A = I_{LINE}Z$$

$$Z = \frac{RX}{\sqrt{R^2 + X^2}} \text{ (RLC)}$$

Transformers (Step-Up or Step-Down Ratios)

$$\frac{N_p}{N_s} = \frac{E_p}{E_s} = \frac{I_s}{I_p} = \sqrt{\frac{Z_p}{Z_s}}$$

Common 1% Resistor Values

1% standard values decade multiples are available from 10.0 Ω through 1.00 MΩ (also 1.10 MΩ, 1.20 MΩ, 1.30 MΩ, 1.50 MΩ, 1.60 MΩ, 1.80 MΩ, 2.00 MΩ, and 2.20 MΩ).

Standard base resistor values are given in the following table for the most commonly used tolerance (1%), along with typically available resistance ranges. To determine values other than the base, multiply the base value by 10, 100, 1000, or 10,000.

10.0	10.2	10.5	10.7	11.0	11.3	11.5	11.8	12.1	12.4	12.7	13.0
13.3	13.7	14.0	14.3	14.7	15.0	15.4	15.8	16.2	16.5	16.9	17.4
17.8	18.2	18.7	19.1	19.6	20.0	20.5	21.0	21.5	22.1	22.6	23.2
23.7	24.3	24.9	25.5	26.1	26.7	27.4	28.0	28.7	29.4	30.1	30.9
31.6	32.4	33.2	34.0	34.8	35.7	36.5	37.4	38.3	39.2	40.2	41.2
42.2	43.2	44.2	45.3	46.4	47.5	48.7	49.9	51.1	52.3	53.6	54.9
56.2	57.6	59.0	60.4	61.9	63.4	64.9	66.5	68.1	69.8	71.5	73.2
75.0	76.8	78.7	80.6	82.5	84.5	86.6	88.7	90.9	93.1	95.3	97.6

Common Capacitor Values

pF	pF	pF	pF	μF	μF	μF	μF	μF	μF	μF	μF
1.0	10	100	1000	0.01	0.1	1.0	10	100	1000	10,000	
1.1	11	110	1100								
1.2	12	120	1200								
1.3	13	130	1300								
1.5	15	150	1500	0.015	0.15	1.5	15	150	1500		
1.6	16	160	1600								
1.8	18	180	1800								
2.0	20	200	2000								
2.2	22	220	2200	0.022	0.22	2.2	22	220	2200		
2.4	24	240	2400								
2.7	27	270	2700								
3.0	30	300	3000								
3.3	33	330	3300	0.033	0.33	3.3	33	330	3300		
3.6	36	360	3600								
3.9	39	390	3900								
4.3	43	430	4300								
4.7	47	470	4700	0.047	0.47	4.7	47	470	4700		
5.1	51	510	5100								
5.6	56	560	5600								
6.2	62	620	6200								
6.8	68	680	6800	0.068	0.68	6.8	68	680	6800		
7.5	75	750	7500								
8.2	82	820	8200								
9.1	91	910	9100								



Amplifier Packaging

ADI offers a wide variety of plastic packages from through-hole to surface-mount applications. Many of these plastic packages provide cost-effective solutions to achieving greater board density (surface-mount packages) and high performance. Plastic packages are extensively used in many of today's applications.

Analog Devices offers molded plastic packages and the primary materials are a leadframe, die attach material, bond wire, mold compound, and a Pb-free finish. In order to provide plastic package solutions that do not sacrifice reliability or functionality, Analog Devices continues to improve on the materials used, whether focusing on leadframe composition for increased thermal conductivity, low stress mold compound used for large die applications, or low moisture absorption mold compounds for improved reliability.

Improvements in the small surface-mount packages include the introduction of the devices offered in small body size packages. The following table provides information on smaller plastic packages offered by Analog Devices.

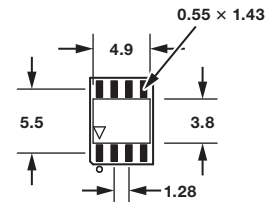
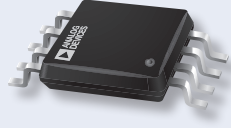
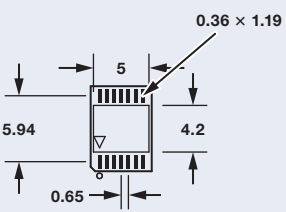
For more information about ADI's packaging, please refer to: www.analog.com/pcb_design_resources.

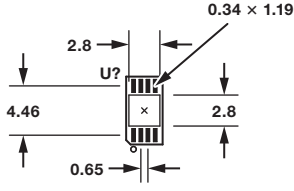
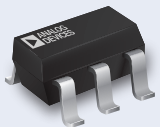
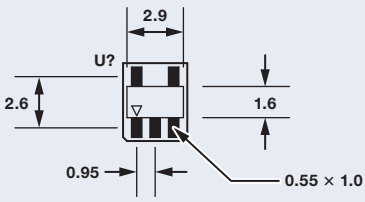
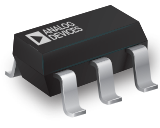
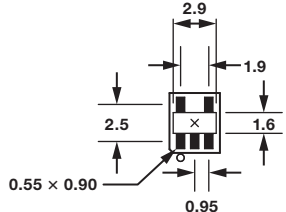
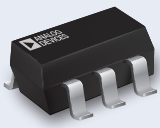
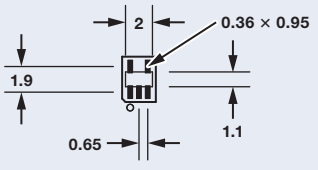
Package Type	Package Dimensions	Package Characteristics	Package Footprint
Small outline integrated circuit (SOIC)	8-lead: 4.0 mm × 6.0 mm × 1.55 mm 14-lead: 8.65 mm × 6.0 mm × 1.55 mm 	<ul style="list-style-type: none"> • Surface-mount package • Solder plate Pb-free finish • Molded package • Package suffix—"R" 	
Thin shrink small outline package (TSSOP)	8-lead: 3.0 mm × 6.4 mm × 1.2 mm 14-lead: 5.0 mm × 6.4 mm × 1.2 mm 	<ul style="list-style-type: none"> • Surface-mount package • Solder plate Pb-free finish • Molded package • Package suffix—"RU" 	
Microsmall outline package (MSOP)	8-lead: 3.0 mm × 4.9 mm × 1.1 mm 10-lead: 3.0 mm × 4.9 mm × 1.1 mm 	<ul style="list-style-type: none"> • Surface-mount package • Solder plate Pb-free finish • Molded package • Package suffix—"RM" 	
Small outline transistor package (SOT-23)	5-lead: 2.9 mm × 2.8 mm × 1.45 mm 6-lead: 2.9 mm × 2.8 mm × 1.45 mm 	<ul style="list-style-type: none"> • Surface-mount package • Solder plate Pb-free finish • Molded package • Package suffix—"RJ" 	
Thin small outline transistor package (TSOT-23)	5-lead: 2.9 mm × 2.8 mm × 1.1 mm 	<ul style="list-style-type: none"> • Surface-mount package • Solder plate Pb-free finish • Molded package • Package suffix—"UJ" 	
Thin shrink small outline transistor package (SC70)	5-lead: 2 mm × 2.1 mm × 1.1 mm 	<ul style="list-style-type: none"> • Surface-mount package • Solder plate Pb-free finish • Molded package • Package suffix—"KS" 	

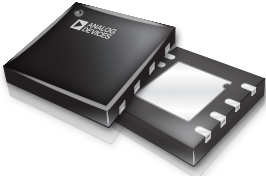
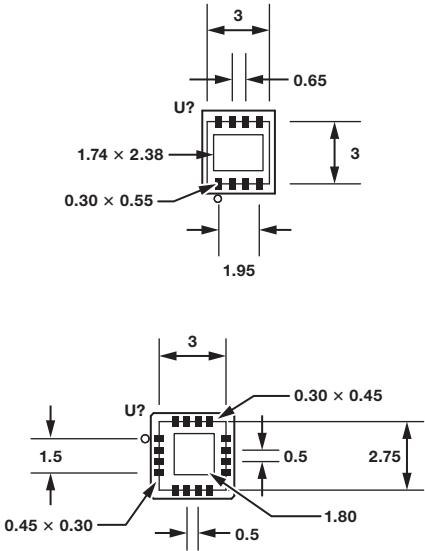
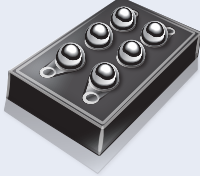
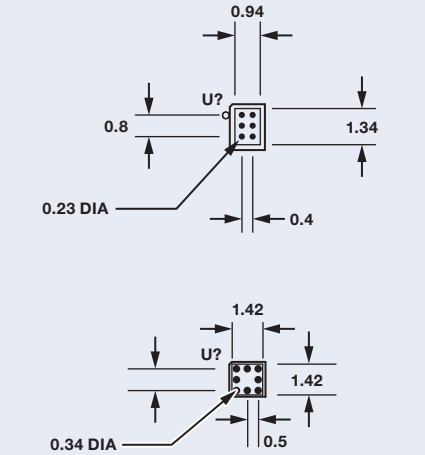
Package Type	Package Dimensions	Package Characteristics	Package Footprint (mm)
Lead frame chip scale package (LFCSP)	<p>8-lead: 2 mm × 2 mm × 0.55 mm; 0.5 mm pitch</p> <p>8-lead: 3 mm × 3 mm × 0.75 mm; 0.5 mm pitch</p> <p>8-lead: 3 mm × 3 mm × 0.85 mm; 0.5 mm pitch</p> <p>10-lead: 1.3 mm × 1.6 mm × 0.55 mm; 0.4 mm pitch</p> <p>10-lead: 2 mm × 2 mm × 0.55 mm; 0.5 mm pitch</p> <p>16-lead: 3 mm × 3 mm × 0.75 mm; 0.5 mm pitch</p> <p>16-lead: 4 mm × 4 mm × 0.75 mm; 0.65 mm pitch</p> 	<ul style="list-style-type: none"> • Surface-mount package • Leadless package • Solder plate Pb-free finish • Molded package • Exposed pad for thermal performance • Package suffix—"CP" 	
Wafer level chip scale package (WLCSP)	<p>6-ball: 0.905 mm × 1.385 mm × 0.6 mm; 0.4 mm pitch</p> <p>8-ball: 1.42 mm × 1.42 mm × 0.595 mm; 0.5 mm pitch</p> <p>9-ball: 1.21 mm × 1.22 mm × 0.6 mm; 0.4 mm pitch</p> <p>14-ball: 1.46 mm × 2.96 mm × 0.595 mm; 0.5 mm pitch</p> 	<ul style="list-style-type: none"> • Surface-mount package • Ball array • Solder ball Pb-free finish • Package suffix—"CB" 	

Op Amp Glossary

Common-Mode Voltage Range (CMVR)

Also known as input voltage range, CMVR is the allowable input voltage range at both inputs before clipping or excessive nonlinearity is seen at the output.

Common-Mode Rejection Ratio (CMRR)

The ratio of the common-mode voltage range (CMVR) to the change in the input offset voltage (ΔV_{OS}) over this range. The result is expressed in dB.
 $CMRR \text{ (dB)} = 20 \log (CMVR/\Delta V_{OS})$

Full Power Bandwidth

The maximum frequency measured at unity gain for which the rated output voltage can be obtained for a sinusoidal signal at rated load without distortion due to slew rate limiting.

Gain Bandwidth Product (GBW)

The product of open-loop gain and bandwidth at a specific frequency.

Input Bias Current (I_b)

The current at the input terminals.

Input Bias Current Drift

The proportional change in input bias current vs. temperature over a specified range of temperature.

Input Offset Current

The difference between the two input currents.

Input Offset Current Drift

The ratio of input offset current change over a specified temperature range, with the output held a constant voltage.

Input Offset Voltage Drift ($T_c V_{OS}$)

The ratio of change in input offset voltage to a change in temperature.

Offset Voltage (V_{OS})

The differential voltage needed across the op amp input terminals to obtain zero output voltage. Offset voltage values range varies by process and design technology:

- Auto-zero op amps: $<1 \mu V$
- Precision op amps: $50 \mu V$ to $500 \mu V$
- Best bipolar op amps: $10 \mu V$ to $25 \mu V$
- Best JFET input op amps: $100 \mu V$ to $1000 \mu V$
- Best bipolar high speed op amps: $100 \mu V$ to $2000 \mu V$
- Untrimmed CMOS op amps: $>2 \text{ mV}$
- DigiTrim® CMOS op amps: $<100 \mu V$ to $1000 \mu V$

Open-Loop Gain (A_{VO})

The ratio of the output voltage to the input offset voltage between the two input pins. The result is expressed in dB. Gain is usually specified only at dc (A_0), but for many applications, such as high speed amplifiers for video and RF, the frequency dependence of gain is also important. For this reason the open loop gain and phase response is published for each amplifier.

Operating Supply Voltage Range

The supply voltage range that can be applied to an amplifier for which it operates within specifications. Many applications implement op amp circuits with balanced dual supplies, while other applications for energy conservation or other reasons, use single-supply. For example, battery power in automotive and marine equipment provides only a single polarity. Even line-powered equipment, such as computers, may have only a single-polarity built-in supply, furnishing 5 V or 12 V dc for the system, or often as low as 1.8 V, with newer applications going even lower.

Power Supply Rejection Ratio (PSRR)

The ratio of the change in power supply voltage to the change in input offset voltage. The result is expressed in dB. $PSRR = 20 \log (\Delta V_{SI}/\Delta V_{OS})$

Settling Time

The amount of time required for an amplifier to settle to some predetermined level of accuracy or percentage of output voltage after the application of a step input.

Slew Rate

The maximum rate of change of output voltage under large signal condition. The result is usually expressed in $V/\mu s$.

Supply Current

The current required from the supply voltage to operate the amplifier with no load.

Small Signal Unity-Gain Frequency

The frequency at which the open-loop gain is unity or 0 dB. This applies only to signals under 200 mV. Due to slew rate limiting, it is not possible to obtain large output voltage swings at high frequencies.

Amplifier Design Technology

Clamp Amplifiers

Clamp amplifiers allow the designer to specify a high (VCH) and low (VCL) output clamp voltage so the output signal will clamp at the specified levels. Analog Devices' unique CLAMPIN™ input clamp architecture offers significant improvement in clamp performance compared to traditional output clamping devices, minimizing clamp error and distortion in the clamp region.

Common-Mode Linearized Amplifiers

Increasing the linear input range of the input stage optimizes operational amplifier large signal distortion. This can be accomplished through the use of architectures such as degenerated differential structures and class AB input stages, both of which increase noise and lower precision. An alternate method is to linearize using a common-mode structure whose noise is rejected by the inherent differential nature of the input stage while also maintaining such precision metrics as CMRR, PSRR, and V_{OS} . Analog Devices has numerous new amplifiers that now feature this new technology and has patented the common-mode linearized input architecture.

Current Feedback Amplifiers

Current feedback amplifiers are primarily used in applications that require very high speed operation, large slew rates, and low distortion. The fundamental concept is based on the fact that, in bipolar transistor circuits, currents can be switched faster than voltages, all other things being equal. Unlike voltage feedback amplifiers (VFB), CFB amplifiers do not have balanced inputs. Instead, the noninverting input is high impedance, and the inverting input is low impedance. The open-loop gain of the CFB is measured in units of Ω (transimpedance gain) rather than V/V as for VFB amplifiers. Also, the value of the feedback resistor plays a direct role in the CFB's stability. Therefore, adhering to the recommended feedback resistor suggested in the data sheet is highly recommended.

Differential Amplifiers

Differential amplifiers allow the process of single-ended input to complementary differential outputs or differential inputs to differential outputs. These amplifiers feature two separate feedback loops to control the differential and common-mode output voltages. Analog Devices' differential amplifiers are configured with a V_{OCM} pin, which can be easily adjusted for setting output common-mode voltage. This provides a convenient solution when interfacing with analog-to-digital converters (ADCs). ADI also offers a series of differential receiver products that convert differential input signals to single-ended output.

Quad Core (H Bridge)

Analog Devices has patented the quad core architecture, which supplies *current on-demand* to charge and discharge the internal dominant pole capacitor, while allowing the quiescent current to be small. This patented architecture enables amplifiers to provide high slew rates with low distortion at low supply currents.

Overvoltage Protection (OVP) Amplifiers

An OVP amplifier is the most robust solution to protect the amplifier and entire circuitry from outside the rail input voltages due to manufacturing shorts, power supply timing, or human error. OVP is able to protect real estate from various unexpected errors, which in turn save time and money. OVP amplifiers require no external circuitry to provide protection.

Zero-Drift Amplifiers

Zero-drift amplifiers dynamically correct the offset voltage to achieve nanovolt-level offsets and extremely low offset drifts due to time and temperature. The $1/f$ noise, seen as a dc error, is also removed. Zero-drift amplifiers provide many benefits to designers, as temperature drift and $1/f$ noise, always nuisances in the system, are otherwise very difficult to eliminate. In addition, zero-drift amplifiers have higher open-loop gain, power supply rejection, and common-mode rejection as compared to standard amplifiers; and their overall output error is less than that obtained by a standard precision amplifier in the same configuration.

Zero Input Crossover Distortion (ZCO) Amplifiers

Traditional rail-to-rail input amplifiers have an input stage that comprises two differential pairs, a p-type and an n-type. During the transition of the input common-mode voltage from the lower to the higher supply voltage, one of the differential pairs turns off and the other turns on. This transition causes crossover distortion. Zero input crossover distortion (ZCO) amplifiers solve this problem by integrating an on-chip charge pump. The charge pump increases the internal supply voltage, thus providing more headroom to the input stage. This allows the input stage to handle a wider range of input voltages (rail-to-rail) without using a second differential pair. As a result, crossover distortion is avoided.

Amplifier Process and Trimming Technology

Process Technology

Bipolar

Bipolar technology delivers the best overall performance amplifiers. It offers high output current drive, high voltage operation, and low noise.

Extremely Fast Complementary Bipolar (XFCB 1.5)

Analog Device's XFCB 1.5 technology is a suite of advanced bipolar fabrication processes that features dielectric isolation, high speed complementary NPNs and PNP's with 3 GHz to 8 GHz frequency transition, precision capacitors, and low temperature-coefficient thin film resistors that can be trimmed at the wafer level. Dielectric isolation allows much tighter spacing between components and removes the possibility of latch-up. Nonlinear device-to-substrate capacitance that limits device speed and distortion performance is eliminated. XFCB1.5 has supply voltage options from 8 V to 26 V; this allows the selection of the fastest devices possible for the required input and output voltage ranges.

XFCB3

Analog Devices' XFCB3 technology features full dielectric isolation, silicon-germanium hetero-junction NPNs with frequency transition up to 50 GHz and double-poly PNP's with frequency transition up to 18 GHz, precision capacitors, and low temperature, coefficient thin film resistors. Minimum feature size is a factor of three less than XFCB1.5. This process family has enabled a new generation of high speed, ultralow distortion differential amplifiers and op amps.

36 V *i*Polar

Analog Devices' *i*Polar™ 36 V precision bipolar process is highly optimized for linear circuits, yielding new levels of performance, size, and value. The *i*Polar process combines the advantages of precision bipolar and JFET with lateral dielectric isolation and modular processing. The transistors on *i*Polar devices have been redesigned from the ground up and are optimized for speed, noise, matching, linearity, and stability at lower power levels. This enables greater signal chain integration without compromising performance.

16 V *i*CMOS Amplifiers

Analog Devices' *i*CMOS industrial manufacturing process technology combines submicron CMOS with high voltage complementary bipolar technologies. It enables the development of a wide range of high performance analog ICs capable of 30 V operation in a smaller footprint. Unlike analog ICs using conventional CMOS processes, *i*CMOS components can tolerate high supply voltages, while providing increased performance, dramatically lower power consumption, and reduced package size. *i*CMOS components tolerate high voltages (greater than 6 V regular CMOS amps) while employing digital design techniques such as auto-zero and DigiTrim technologies.

JFET Input Amplifiers

JFET input amplifiers have the advantage over bipolar devices by having an extremely high input impedance along with low noise performance, making them very useful in amplifier circuits using very small signals such as high source impedance sensors and photodiodes. A typical JFET has a voltage noise slightly larger than a BJT, but its current noise is significantly lower.

Trimming Technology

Laser Trim

When extremely fine adjustment is required, laser trimming is most effective. By controlling the path and speed of the laser beam, the resistor's value can be adjusted to very precise values. Analog Devices pioneered the use of thin film resistors and laser trimming and uses this technology extensively in precision amplifiers, references, and converters.

Zener Zapping

With each zap removing a predefined resistance value, the nature of the trims is discrete. It is most cost-effective for fairly large geometry processes. Analog Devices pioneered the use of Zener-zap trimming and created the industry-standard OP07 precision amplifier.

DigiTrim

Analog Devices' DigiTrim is a patented in-package trimming process that delivers guaranteed high accuracy. This in-package process technology eliminates the need for laser trimming during manufacturing and minimizes the input offset of operational amplifiers.

All prices in this brochure are in USD in quantities greater than 1000, recommended lowest grade resale. FOB U.S.A. Analog Devices Inc. reserves the right to make changes to specifications, prices, and availability.

©2014 Analog Devices, Inc. All rights reserved. Trademarks and registered trademarks are the property of their respective owners.

Printed in the U.S.A.

BR12570-5-10/14

analog.com/amplifiers

**Analog Devices, Inc.
Worldwide Headquarters**

Analog Devices, Inc.
One Technology Way
P.O. Box 9106
Norwood, MA 02062-9106
U.S.A.
Tel: 781.329.4700
(800.262.5643,
U.S.A. only)
Fax: 781.461.3113

**Analog Devices, Inc.
Europe Headquarters**

Analog Devices, Inc.
Wilhelm-Wagenfeld-Str. 6
80807 Munich
Germany
Tel: 49.89.76903.0
Fax: 49.89.76903.157

**Analog Devices, Inc.
Japan Headquarters**

Analog Devices, KK
New Pier Takeshiba
South Tower Building
1-16-1 Kaigan, Minato-ku,
Tokyo, 105-6891
Japan
Tel: 813.5402.8200
Fax: 813.5402.1064

**Analog Devices, Inc.
Asia Pacific Headquarters**

Analog Devices
5F, Sandhill Plaza
2290 Zuchongzhi Road
Zhangjiang Hi-Tech Park
Pudong New District
Shanghai, China 201203
Tel: 86.21.2320.8000
Fax: 86.21.2320.8222

