

Features

- Glass Passivated Chip
- 2000W Peak Pulse Power Capability with a 10/1000 us Waveform
- Low Inductance
- For Bidirectional Devices Add "C" To The Suffix of The Part Number: i.e.SMB20J20CA for 5% Tolerance
- Halogen Free. "Green" Device (Note 1)
- Moisture Sensitivity Level 1
- Lead Free Finish/RoHS Compliant (Note 2) ("P" Suffix Designates RoHS Compliant. See Ordering Information)

Mechanical Data

- Terminals: Solderable Per MIL-STD-750, Method 2026
- Polarity: Color Band Denotes Positive End (cathode) Except Bidirectiona

Maximum Ratings

- Operating Junction Temperature Range: -55°C to +150°C
- Storage Temperature Range: -55°C to +150°C

Electrical Characteristics @ 25°C Unless Otherwise Specified

Peak Pulse Power Surge Current on 10/1000µs Waveform	I_{PP}	See the Table	Note 3
Peak Pulse Power Dissipation	P_{PP}	2000W	Note 3
Power Dissipation on infinite heat sink	P_D	5.0W	$T_L = 75^\circ C$
Peak forward surge current	I_{FSM}	100A	Note 4
Maximum instantaneous forward voltage at 25A for unidirectional only	V_F	5.0V	

- Notes: 1.Halogen free "Green"products are defined as those which contain <900ppm bromine, <900ppm chlorine (<1500ppm total Br + Cl) and <1000ppm antimony compounds.
 2.High Temperature Solder Exemption Applied, see EU Directive Annex 7a.
 3.Non-repetitive current pulse, per Fig.3 and derated above $T_A=25^\circ C$ per Fig.4
 4.Measured on 8.3 ms single half sine-wave or equivalent square wave, duty cycle =4 pulses per minute maximum.

Pin Configuration:

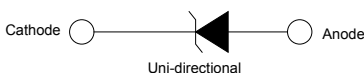

2000 Watt TVS 20 to 58 Volts

SMB (DO-214AA) (LEAD FRAME)

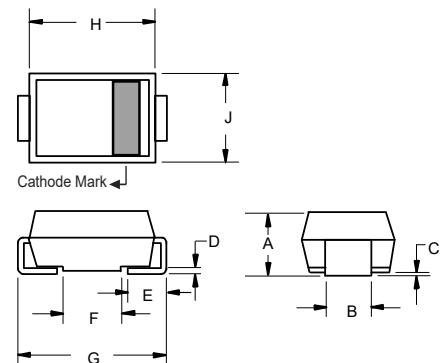

DIM	INCHES		MM		NOTE
	MIN	MAX	MIN	MAX	
A	0.079	0.103	2.00	2.62	
B	0.075	0.087	1.91	2.21	
C	0.002	0.008	0.05	0.20	
D	0.006	0.012	0.15	0.31	
E	0.030	0.060	0.76	1.52	
F	0.065	0.091	1.65	2.32	
G	0.200	0.220	5.08	5.59	
H	0.160	0.191	4.06	4.85	
J	0.130	0.155	3.30	3.94	

Suggested Solder Pad Layout

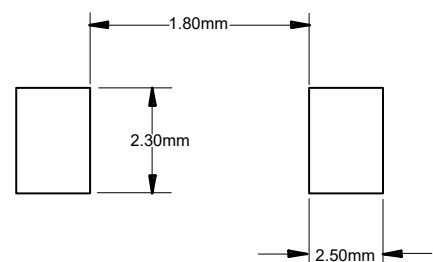

Electrical Characteristics @ 25°C Unless Otherwise Specified

MCC Part Number		Breakdown Voltage V_{BR} @ I_T			Maximum Reverse Leakage I_R @ V_{RWM} (μA)	Working Peak Reverse Voltage V_{RWM} (V)	Maximum Reverse Surge Current I_{PP} (A)	Maximum Clamping Voltage V_C @ I_{PP} (V)	Device Marking Code	
Uni	Bi	Min (V)	Max (V)	I_T (mA)					Uni	Bi
SMB20J20A	SMB20J20CA	22.20	24.50	1	1.0	20.0	61.73	32.4	20LV	20BV
SMB20J22A	SMB20J22CA	24.40	26.90	1	1.0	22.0	56.33	35.5	20LX	20BX
SMB20J24A	SMB20J24CA	26.70	29.50	1	1.0	24.0	51.41	38.9	20LZ	20BZ
SMB20J26A	SMB20J26CA	28.90	31.90	1	1.0	26.0	47.51	42.1	20ME	20CE
SMB20J28A	SMB20J28CA	31.10	34.40	1	1.0	28.0	44.05	45.4	20MG	20CG
SMB20J30A	SMB20J30CA	33.30	36.80	1	1.0	30.0	41.32	48.4	20MK	20CK
SMB20J33A	SMB20J33CA	36.70	40.60	1	1.0	33.0	37.52	53.3	20MM	20CM
SMB20J36A	SMB20J36CA	40.00	44.20	1	1.0	36.0	34.43	58.1	20MP	20CP
SMB20J40A	SMB20J40CA	44.40	49.10	1	1.0	40.0	31.01	64.5	20MR	20CR
SMB20J43A	SMB20J43CA	47.80	52.80	1	1.0	43.0	28.81	69.4	20MT	20CT
SMB20J45A	SMB20J45CA	50.00	55.30	1	1.0	45.0	27.51	72.7	20MV	20CV
SMB20J48A	SMB20J48CA	53.30	58.90	1	1.0	48.0	25.84	77.4	20MX	20CX
SMB20J51A	SMB20J51CA	56.70	62.70	1	1.0	51.0	24.27	82.4	20MZ	20CZ
SMB20J54A	SMB20J54CA	60.00	66.30	1	1.0	54.0	22.96	87.1	20NE	20DE
SMB20J58A	SMB20J58CA	64.40	71.20	1	1.0	58.0	21.37	93.6	20NG	20DG

1. Add suffix ' CA ' after part number to specify Bi-directional devices

Curve Characteristics

FIG1: Peak Pulse Power Rating Curve

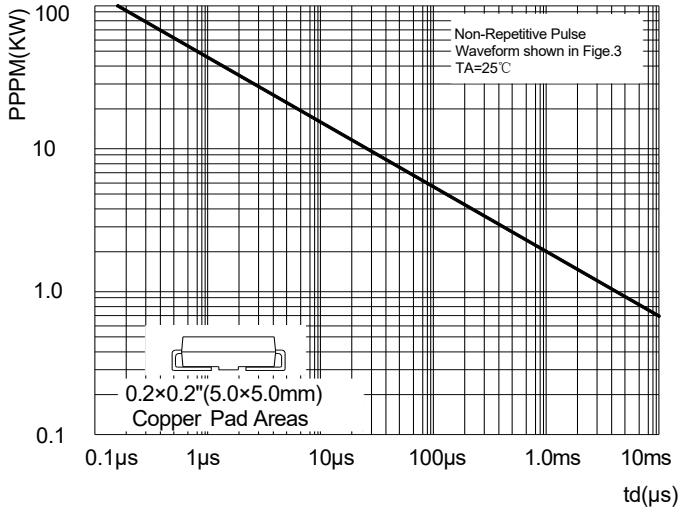

FIG2: Maximum Non-Repetitive Surge Current

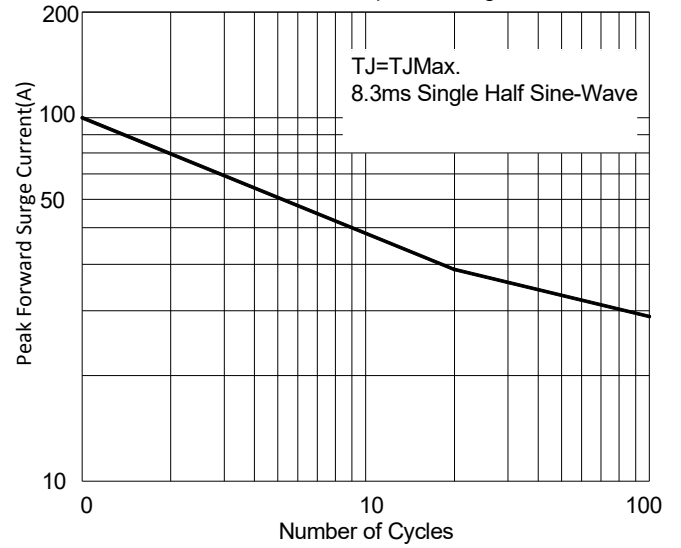

Fig. 3 - Pulse Waveform

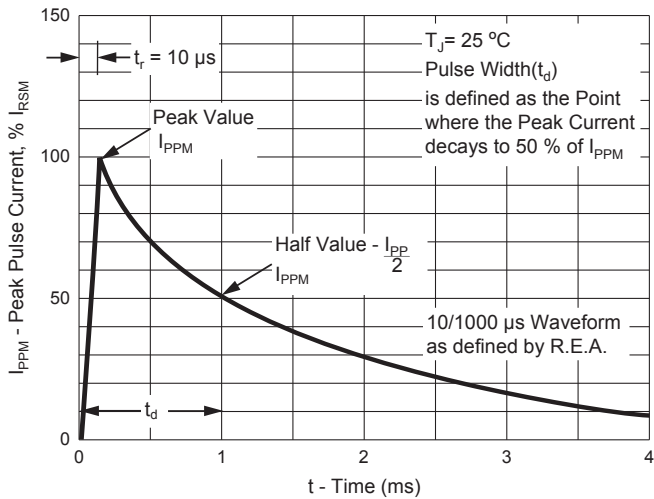
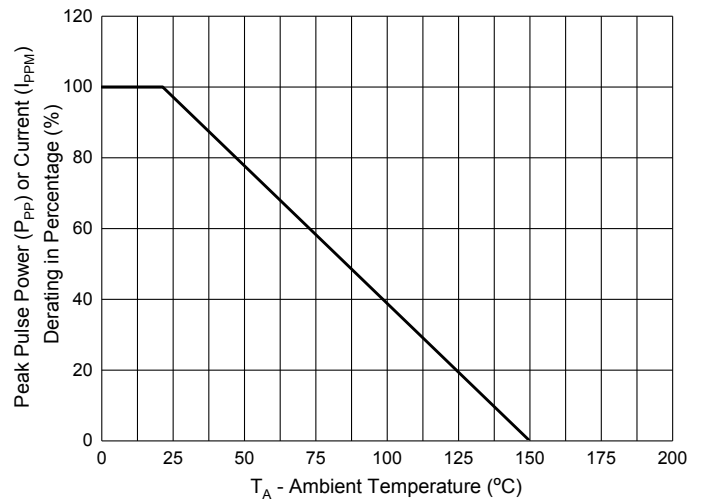

Fig. 4 - Pulse Derating Curve



Ordering Information

Device	Packing
Part Number-TP	Tape&Reel:3Kpcs/Reel

IMPORTANT NOTICE

Micro Commercial Components Corp. reserves the right to make changes without further notice to any product herein to make corrections, modifications, enhancements, improvements, or other changes. **Micro Commercial Components Corp.** does not assume any liability arising out of the application or use of any product described herein; neither does it convey any license under its patent rights, nor the rights of others. The user of products in such applications shall assume all risks of such use and will agree to hold **Micro Commercial Components Corp.** and all the companies whose products are represented on our website, harmless against all damages. **Micro Commercial Components Corp.** products are sold subject to the general terms and conditions of commercial sale, as published at <https://www.mccsemi.com/Home/TermsAndConditions>.

LIFE SUPPORT

MCC's products are not authorized for use as critical components in life support devices or systems without the express written approval of Micro Commercial Components Corporation.

CUSTOMER AWARENESS

Counterfeiting of semiconductor parts is a growing problem in the industry. Micro Commercial Components (MCC) is taking strong measures to protect ourselves and our customers from the proliferation of counterfeit parts. MCC strongly encourages customers to purchase MCC parts either directly from MCC or from Authorized MCC Distributors who are listed by country on our web page cited below. Products customers buy either from MCC directly or from Authorized MCC Distributors are genuine parts, have full traceability, meet MCC's quality standards for handling and storage. **MCC will not provide any warranty coverage or other assistance for parts bought from Unauthorized Sources.** MCC is committed to combat this global problem and encourage our customers to do their part in stopping this practice by buying direct or from authorized distributors.