

Features

- Stable and reliable performance
- Low profile, compact size
- RoHS compliant
- SMT process compatible



Applications

- ISM 2.4 GHz applications
- ZigBee/BLE applications
- Bluetooth earphone systems
- Hand-held devices when WiFi / Bluetooth functions are needed, e.g., Smart phones
- IEEE802.11 b/g/n
- Wireless PCMCIA cards or USB dongles

RoHS Compliant
includes all homogeneous materials
(see part numbering system for details)

Specifications

PN: NAN-CB1B1608AF	
Electrical	
Frequency Range	2400~2500MHz
Center Frequency	2442 MHz
Peak Gain	-0.3 dBi typ.
Efficiency	60% typ.
V.S.W.R	2.5 Max
Polarization	Linear
Impedance	50Ω
Dimensions (mm):	
Body Length (A)	1.6 ± 0.4
Width (B)	0.8 ± 0.3
Thickness (C)	0.3 ± 0.15
Ground Plane	40 mm x 20 mm
Connection Type	SMT

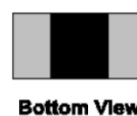
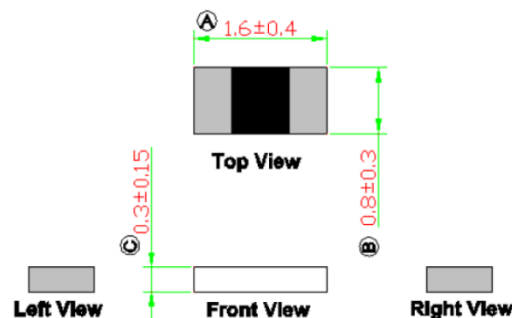
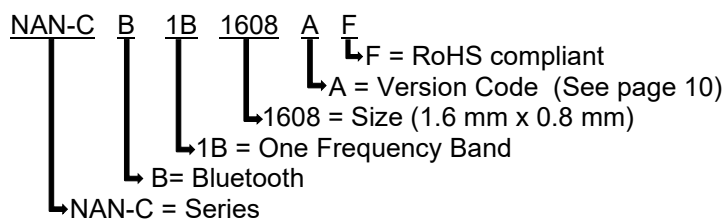

NOTE:
 1. All materials are RoHS compliant.
 2. "A~C" Critical Dimensions.
 3. "()" Reference Dimensions.

Operating & Storage Conditions

Operating	
Maximum Input Power	2W
Operating Temperature	-40°C to 85°C
Storage	
Storage Temperature	-5°C to 40°C
Relative Humidity	20% to 70%
Shelf Life	1 Year

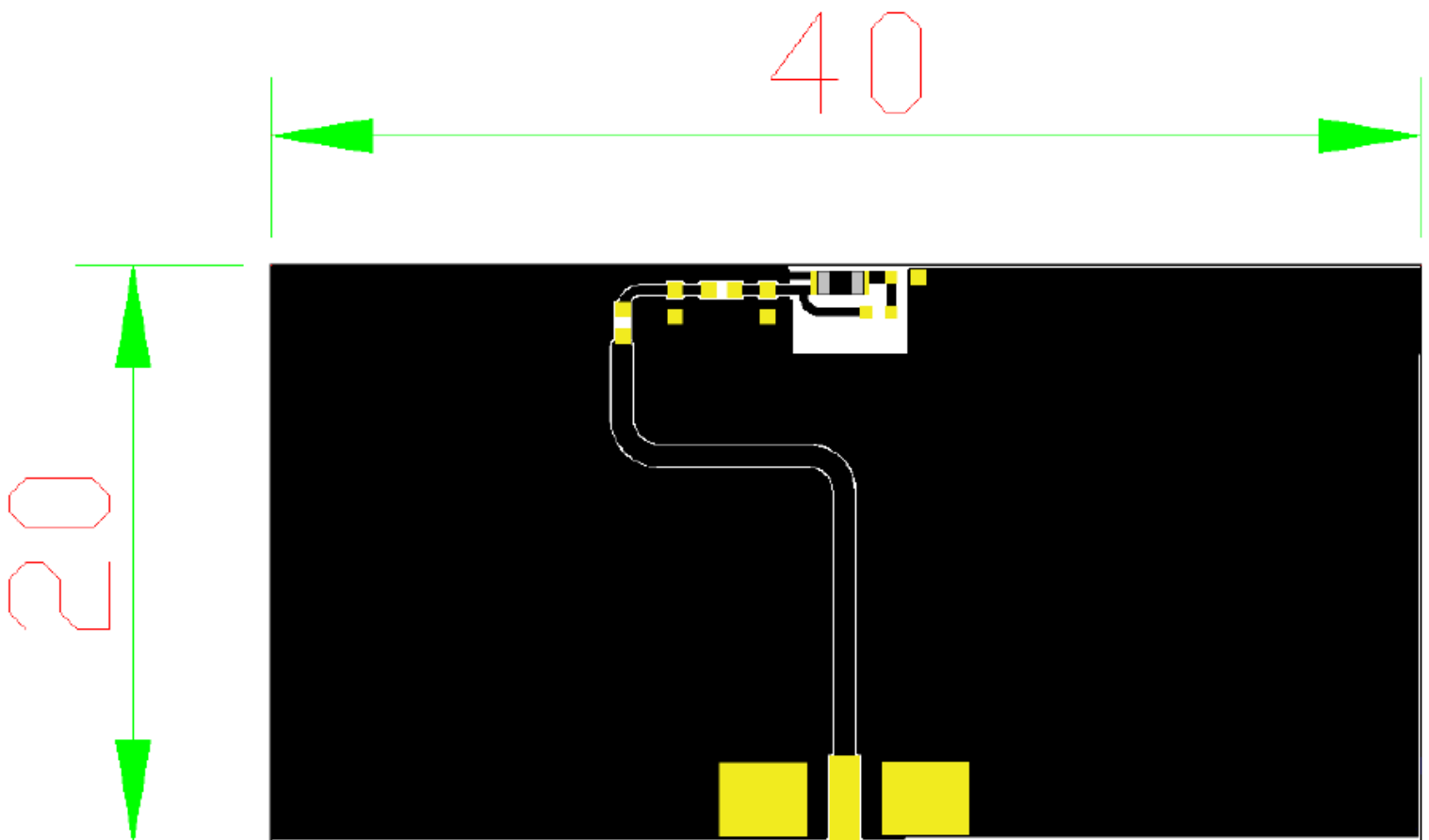
Evaluation Board

Return Loss & V.S.W.R

Return Loss (S₁₁)

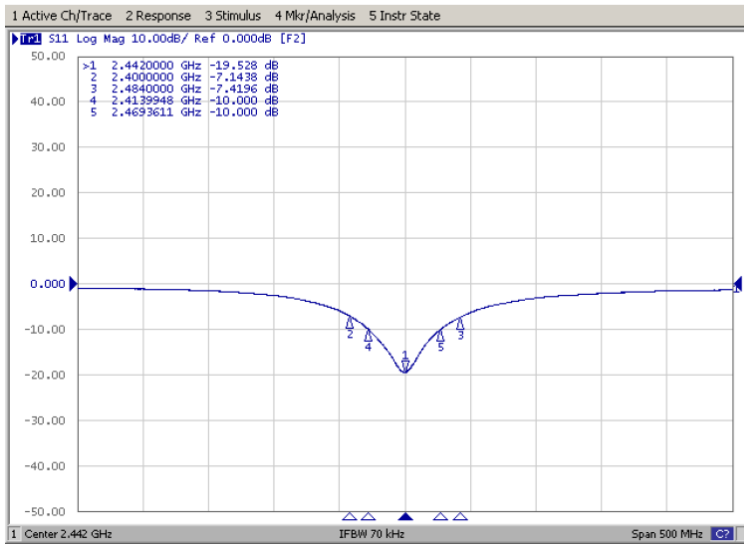

VSWR (S₁₁)

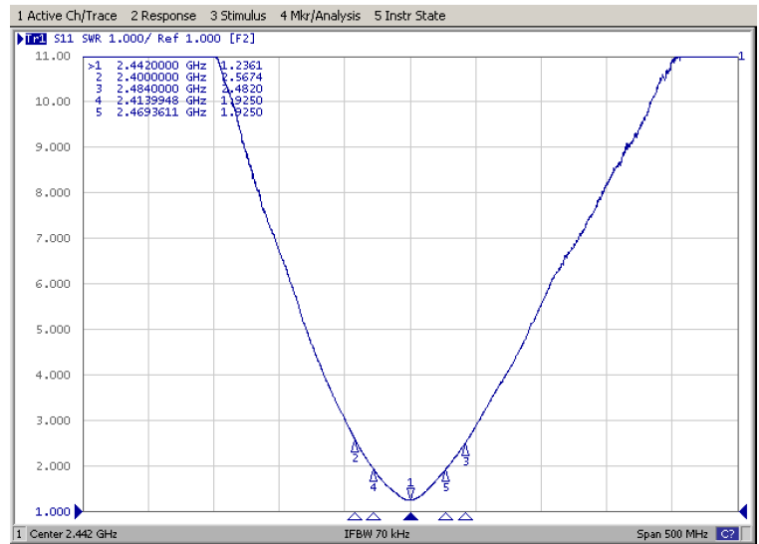

Solder Ground Pattern

The gold areas represent the solder land pattern. Any recommendations on the matching circuit will be provided according to the customer's installation conditions.

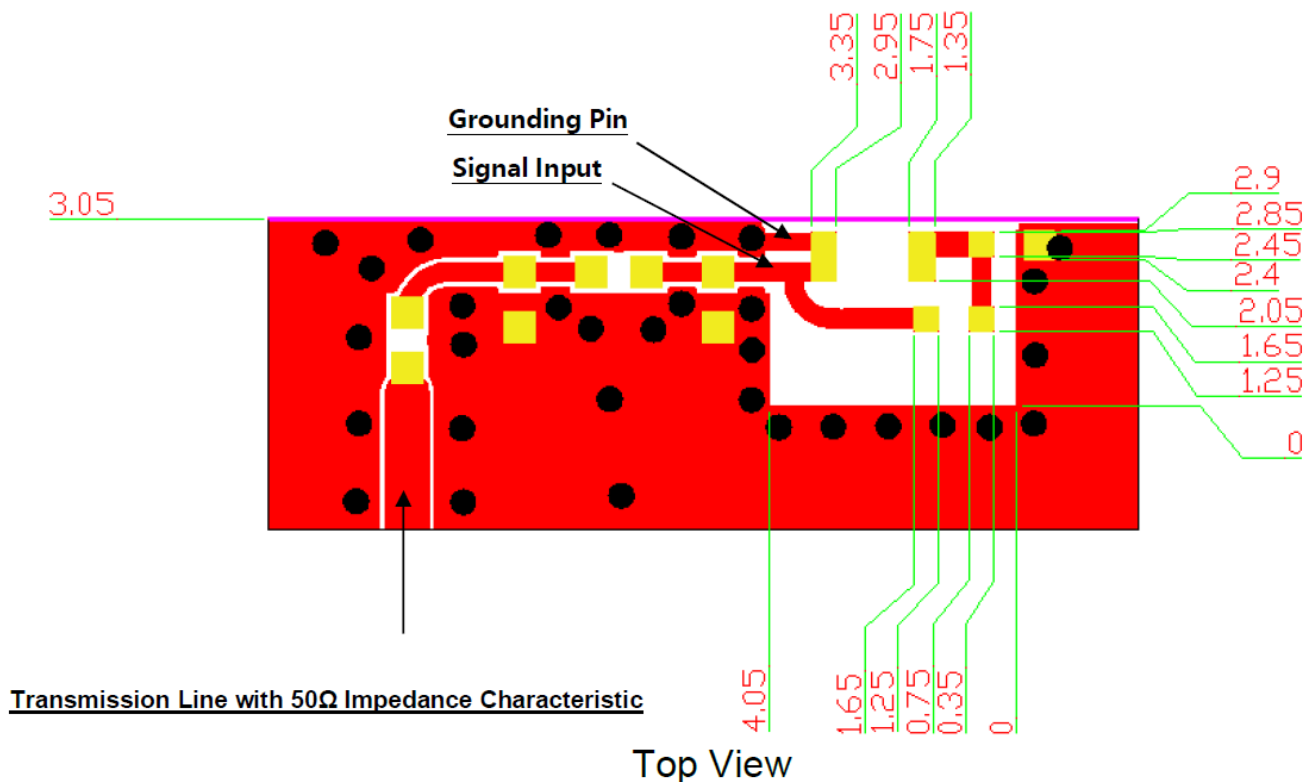

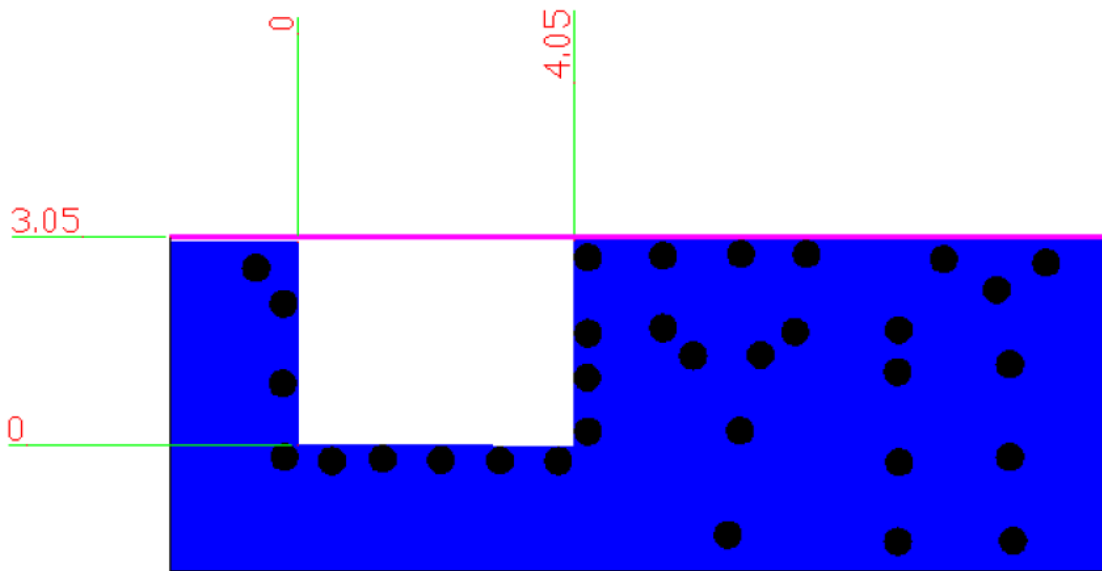

Bottom View

Soldering Conditions

Soldering Profile Limit

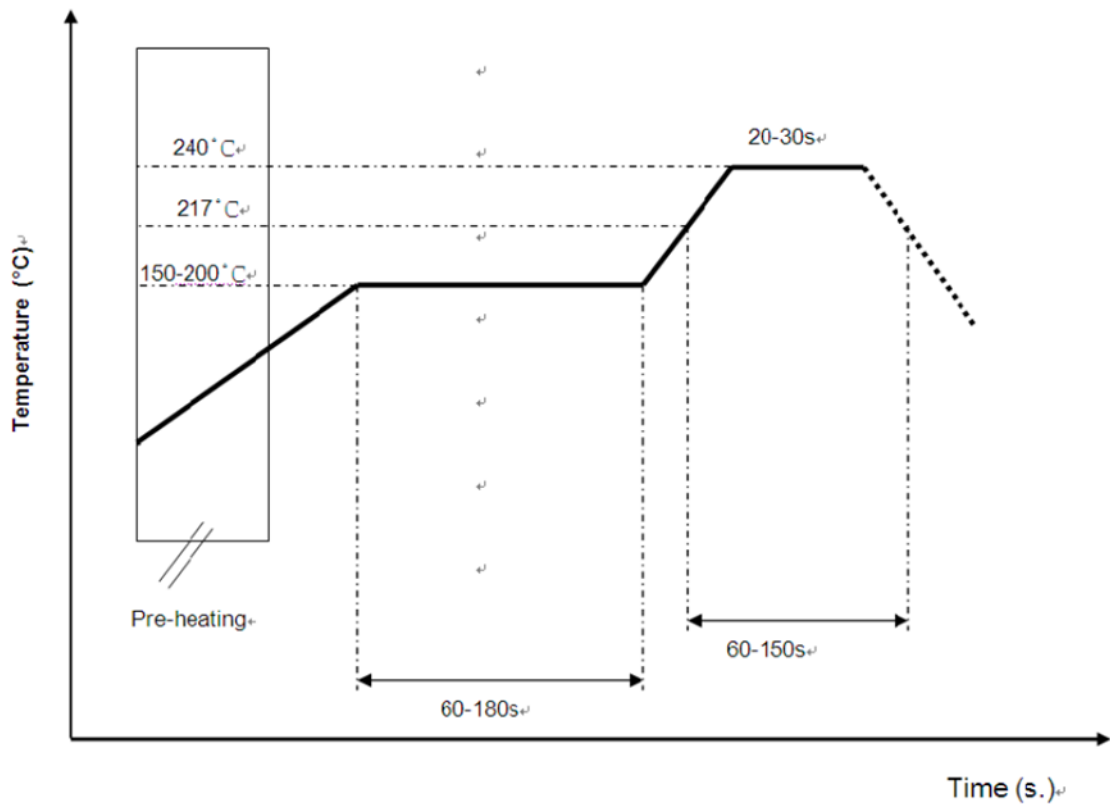

3D Radiation Gain Pattern (with 40 x 20 mm Evaluation Board)

3D Radiation Gain Pattern @ 2442 MHz (unit: dBi)

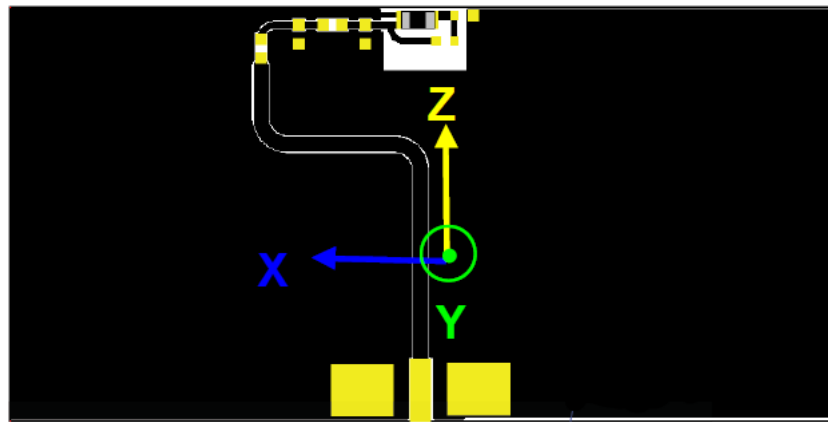
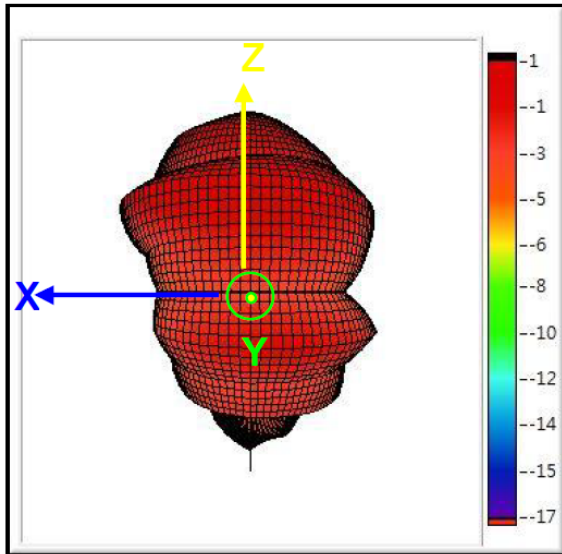
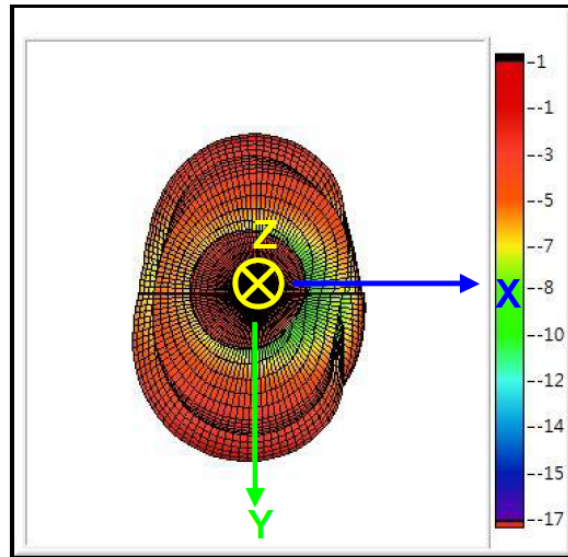
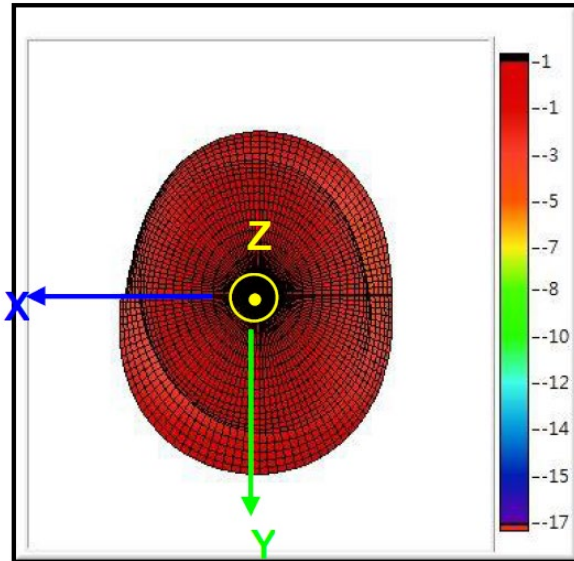

Efficiency Table

Frequency(MHz)	2400	2412	2417	2422	2427	2432	2437	2442	2447	2452	2457	2462	2467	2472	2484	2500
Efficiency(dB)	-3.8	-3.1	-2.9	-2.6	-2.5	-2.4	-2.2	-2.2	-2.3	-2.3	-2.2	-2.3	-2.3	-2.4	-2.7	-4.0
Efficiency(%)	41.8	48.9	51.4	54.6	56.5	58.1	60.1	60.7	58.6	58.3	60.0	59.2	59.0	57.4	53.9	39.5
Peak Gain(dBi)	-2.9	-1.7	-1.2	-0.8	-0.7	-0.7	-0.4	-0.3	-0.4	-0.6	-0.5	-0.7	-0.7	-1.0	-2.5	-3.5

Efficiency Vs. Frequency

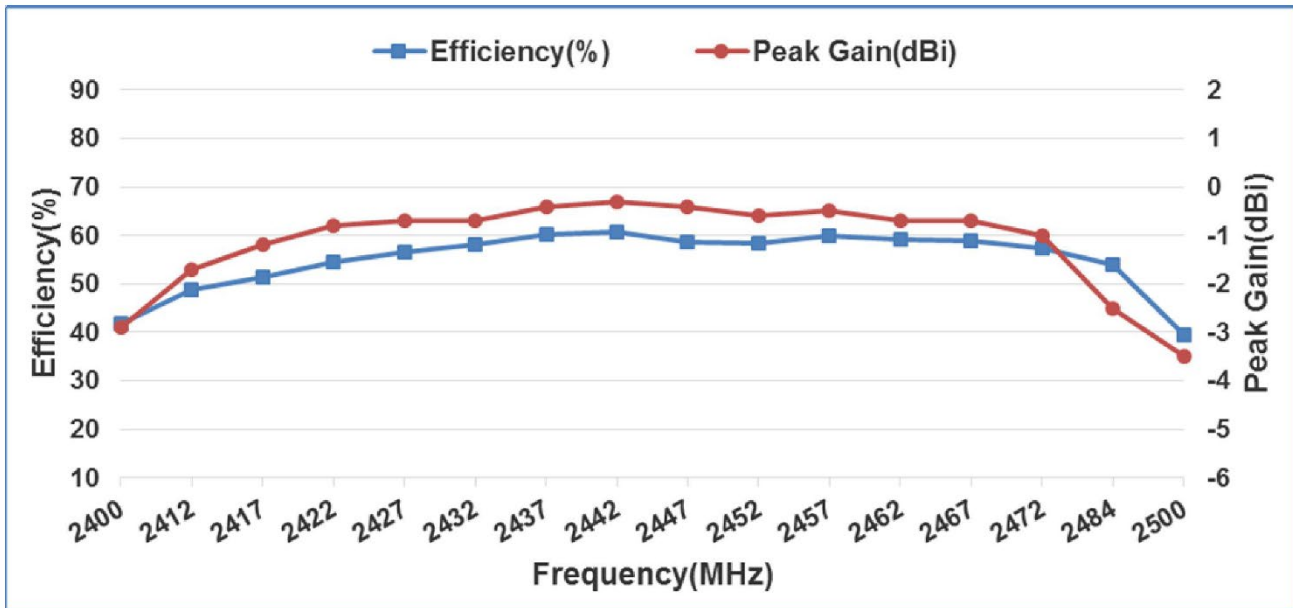

Frequency tuning and Matching circuit

Chip antenna tuning scenario :

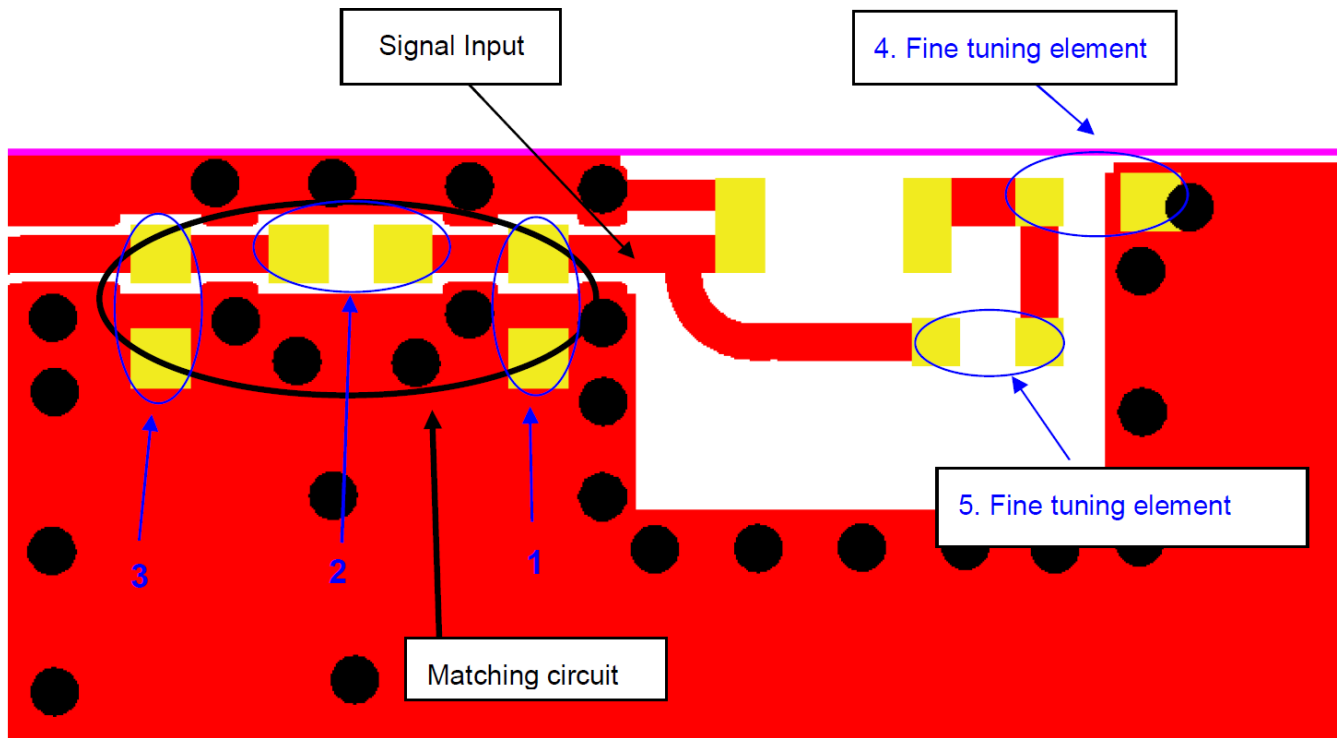

Matching circuit :

The center frequencies will be about 2442 MHz at our standard 40 x 20 mm evaluation board, with the following recommended values of matching and tuning components. *

* = These are typical reference values

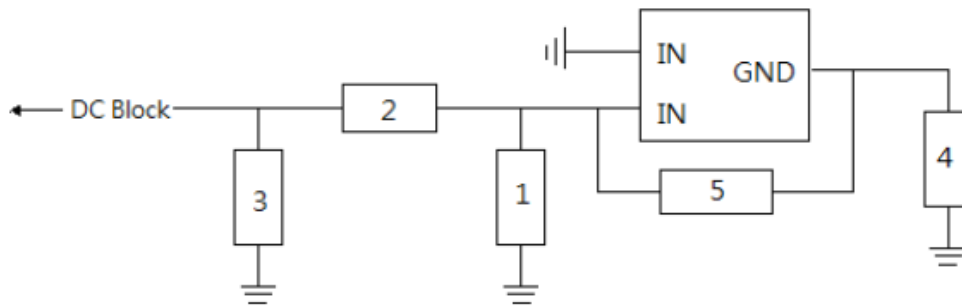

System Matching Circuit Component			
Location	Description	Tolerance	NIC Part Number
1 & 3	N/A	-	-
2	0Ω, (0402)	5%	NRC04ZOTRF
4 Fine Tuning Element	2.2pF, (0402)	±0.1 pF	NMC-Q0402NPO2R2B50TRPE
5 Fine Tuning Element	1.2pF, (0402)	±0.1pF	NMC-Q0402NPO1R2B50TRPE

Reference for Frequency Tuning Element

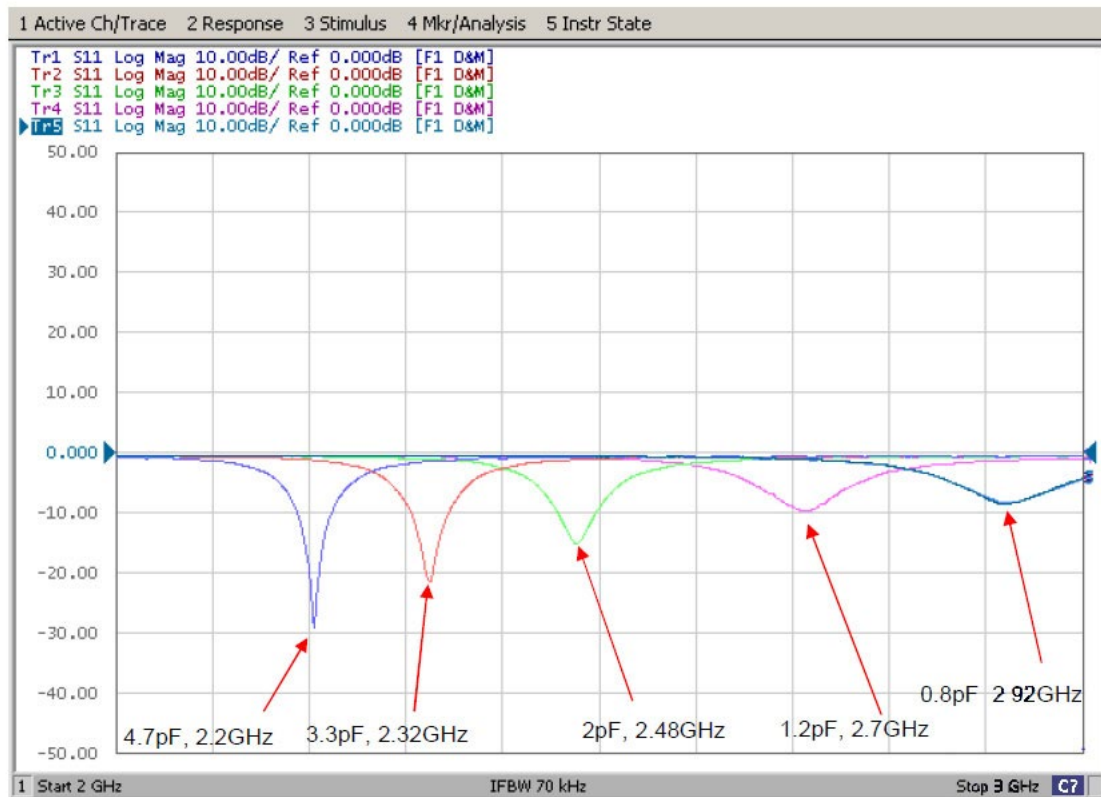
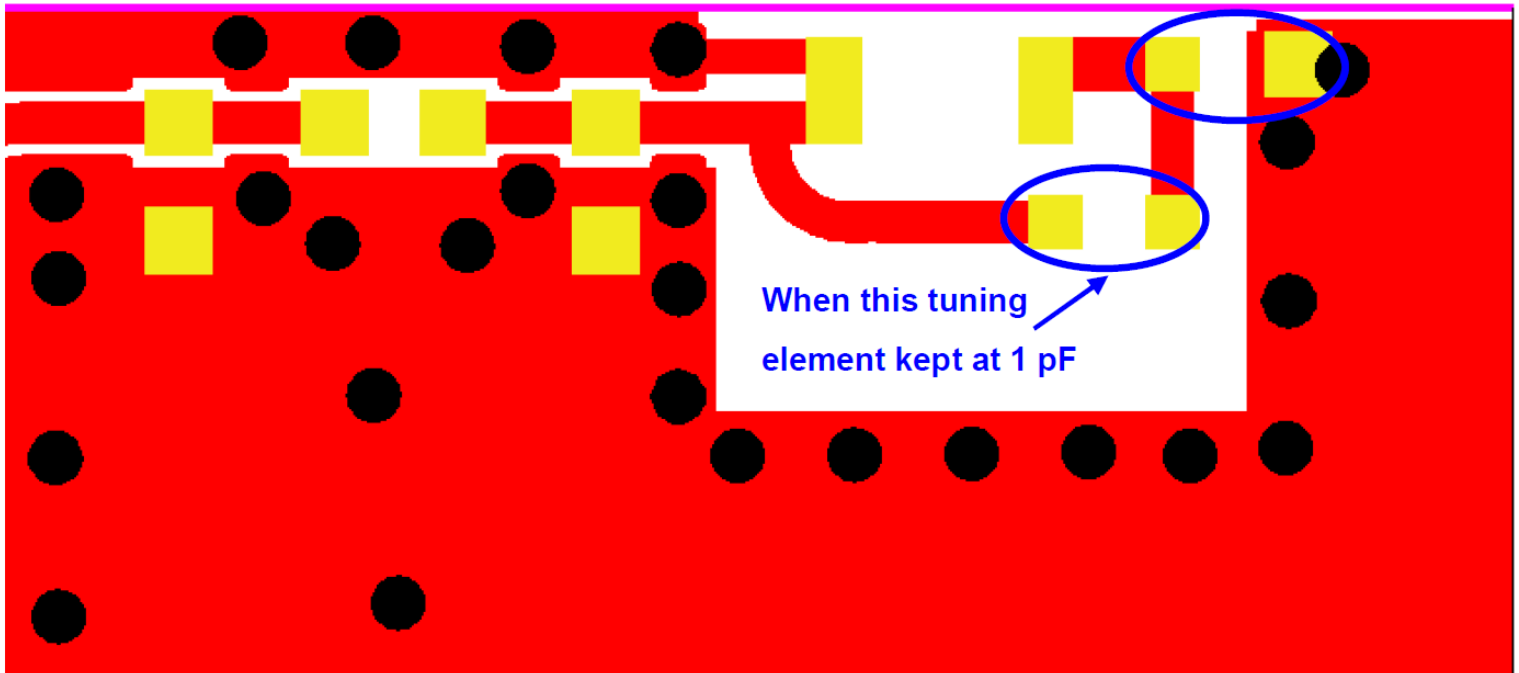

Packing

- (1) Quantity/Reel: 5000 pcs/Reel
- (2) Cardboard tape

a. Tape Drawing

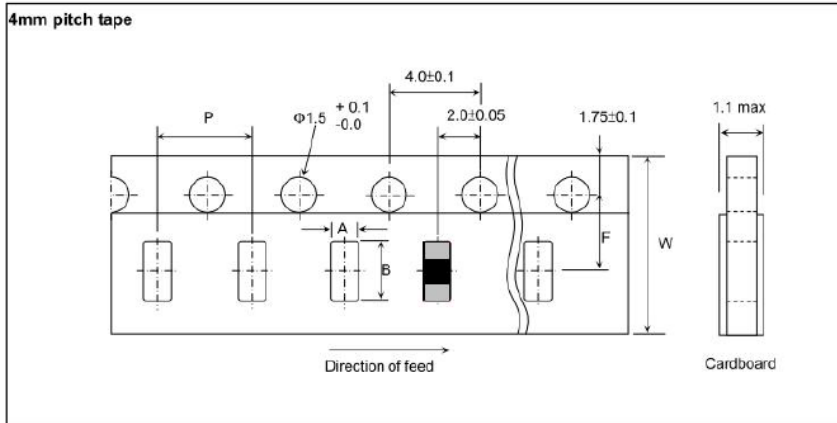

b. Tape Dimensions (unit: mm)

Feature	Specifications	Tolerances
A	1.1	±0.20
B	1.9	±0.20
F	3.5	±0.05
P	4	±0.10
W	8	±0.20

Version History and Status

Version	Date Issued	Details	Status
A	Dec. 11 th , 2020	Initial Release	Supported

Please reach out to NIC for any customization requests and other inquiries:

- NIC Technical Support: tpmg@niccomp.com
- Compliance Support: rohs@niccomp.com