

# Precision SMD VCTCXO

AST3TDA-0000-T

Request Samples



Check Inventory



ESD Sensitive



7.0 x 5.0 x 2.2 mm

RoHS/RoHS II Compliant

MSL Level = 3

## Features

- High stability over industrial temperature range: -40°C to +85°C @ ±280ppb
- HCMOS output
- Voltage-control Functionality

## Applications

- Stratum 3
- Network routers and switches
- COTS Military Radios & other Communication Hardware
- Wireless Communication
- GPS Tracking with Hold-Over Accuracy
- Test & Measurement Equipment
- Autonomous Technologies

## Maximum Ratings

Parameters	Notes
Storage Temperature Range	-55 to +105°C
Supply Voltage	-0.5 to 6V
Control Voltage	0 to 3.3V
ESD, HBM/CDM/MM	4kV/2kV/200V/400V

## Electrical Specifications

Parameters	Min.	Typ.	Max.	Units	Notes
Frequency	38.40			MHz	
Output Waveform	HCMOS				
Operating Temperature	-40		+85	°C	
Storage Temperature	-55		+105	°C	
Frequency Stability over Operating Temperature Range <sup>[Note 1]</sup>	-0.28		+0.28	ppm	
Frequency Stability vs. Supply Voltage Change (V <sub>dd</sub> ±5%)	-0.1		+0.1	ppm	V <sub>cc</sub> =3.3V±5%, V <sub>c</sub> =1.65V
Aging	-1		+1	ppm	First year
	-3		+3	ppm	10 years
Supply Voltage (V <sub>dd</sub> )	3.13	3.3	3.45	V	
Supply Current (I <sub>cc</sub> )			15	mA	@ 25°C, V <sub>cc</sub> =3.3V, O <sub>Load</sub> = 10pF
Start-up Time		2	3	s	
<b>Control Port</b>					
Control Voltage Range (V <sub>c</sub> )	0		3.3	V	
Center Control Voltage (V <sub>c</sub> )		1.65		V	
Modulation Bandwidth		6		kHz	3dB BW
Absolute Pulling Range (APR) <sup>[Note 2]</sup>	-5		+5	ppm	

Note 1: T<sub>A</sub> varied from -40°C to 85°C, measurement referenced to frequency observed with f<sub>ref</sub>=(f<sub>max</sub>+f<sub>min</sub>)/2, V<sub>cc</sub>= 3.3V, V<sub>c</sub>=1.65V, temperature variable speed less than 2°C/min.

Note 2: Sufficient range to correct for initial calibration, 15years aging, temperature, voltage, and load variation



5101 Hidden Creek Ln Spicewood TX 78669  
 Phone: 512-371-6159 | Fax: 512-351-8858  
 For terms and conditions of sales, please visit:  
[www.abracon.com](http://www.abracon.com)

REVISED: 03-14-22

ABRACON IS  
 ISO9001-2015  
 CERTIFIED

# Precision SMD VCTCXO

AST3TDA-0000-T

Request Samples



Check Inventory



ESD Sensitive



7.0 x 5.0 x 2.2 mm  
RoHS/RoHS II Compliant  
MSL Level = 3

## Electrical Specifications *continued*

Parameters	Min.	Typ.	Max.	Units	Notes
Tuning Slope	Positive				
Linearity			10	%	
Port Impedance	10			k $\Omega$	
Phase Noise (@25°C):		-93	-85	dBc/Hz	Offset @10Hz
		-122	-115		Offset @100Hz
		-144	-139		Offset @1kHz
		-163	-155		Offset @10kHz
		-167	-162		Offset @100kHz
		-167	-165		Offset @1MHz
Phase Jitter		70	100	fs	12kHz to 20MHz
V <sub>OH</sub>	2.97			V	V <sub>cc</sub> =3.3V, O <sub>load</sub> =10 pF
V <sub>OL</sub>			0.4	V	V <sub>cc</sub> =3.3V, O <sub>load</sub> =10 pF
Output Load		10		pF	
Duty Cycle	45	50	55	%	@50%
Rise / Fall Time (10%~90%)			10	ns	@25°C

## Typical Phase Noise Characteristics (@ 25°C ± 3°C)

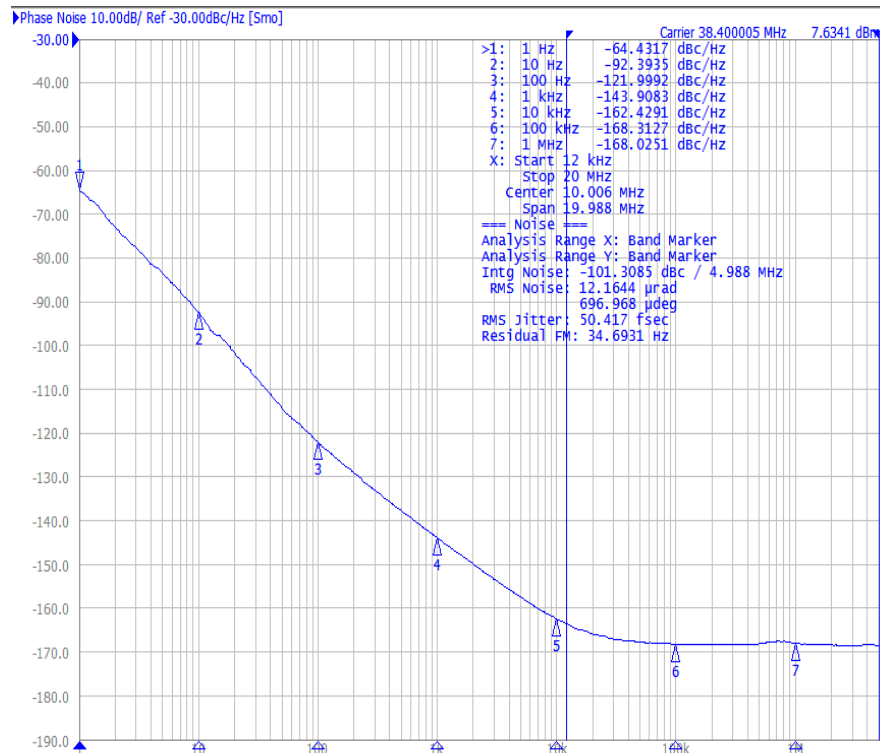

5101 Hidden Creek Ln Spicewood TX 78669  
Phone: 512-371-6159 | Fax: 512-351-8858  
For terms and conditions of sales, please visit:  
www.abracon.com

REVISED: 03-14-22

ABRACON IS  
ISO9001-2015  
CERTIFIED

# Precision SMD VCTCXO

AST3TDA-0000-T

Request Samples



Check Inventory



ESD Sensitive



7.0 x 5.0 x 2.2 mm  
RoHS/RoHS II Compliant  
MSL Level = 3

## Frequency vs. Temperature Characteristics

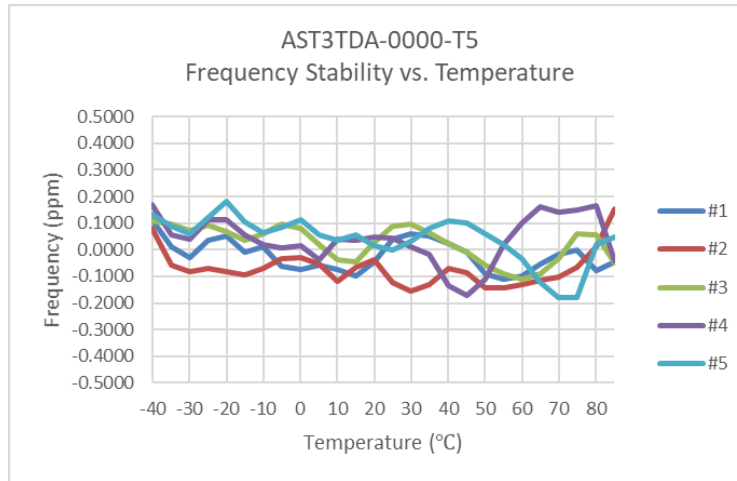

## Frequency Pull vs. Control Voltage (VCTXCO)

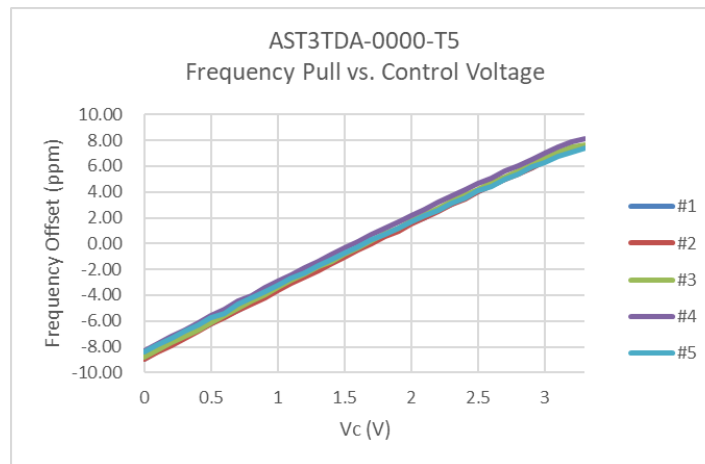

## Part Identification

AST3TDA - 0000 -

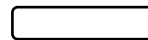

Packaging
Blank: Bulk
T5: 500pcs/reel



5101 Hidden Creek Ln Spicewood TX 78669  
Phone: 512-371-6159 | Fax: 512-351-8858  
For terms and conditions of sales, please visit:  
[www.abracon.com](http://www.abracon.com)

REVISED: 03-14-22

ABRACON IS  
ISO9001-2015  
CERTIFIED

# Precision SMD VCTCXO

AST3TDA-0000-T

Request Samples



Check Inventory



ESD Sensitive



7.0 x 5.0 x 2.2 mm  
RoHS/RoHS II Compliant  
MSL Level = 3

## Mechanical Dimensions

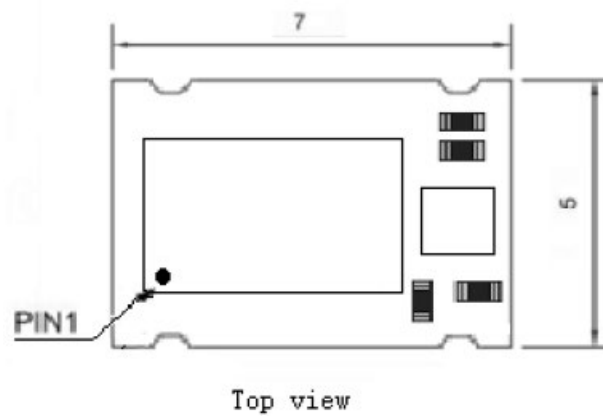
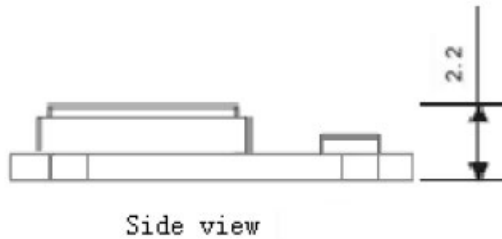
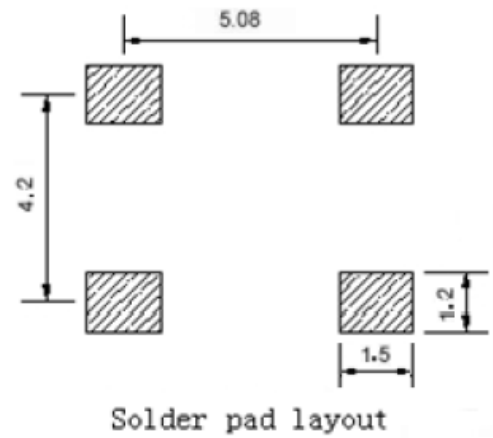
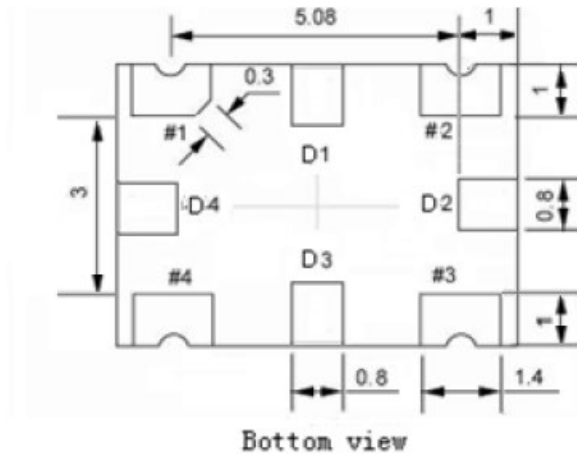

Pin #	Function
D1, D2, D3, D4	No connect
1	Voltage control
2	GND
3	Output
4	Vdd

Dimensions:  
Tolerance  $\pm 0.2$ mm

inches

[mm]

# Precision SMD VCTCXO

AST3TDA-0000-T

Request Samples



Check Inventory



ESD Sensitive



7.0 x 5.0 x 2.2 mm  
RoHS/RoHS II Compliant  
MSL Level = 3

## Test Circuit

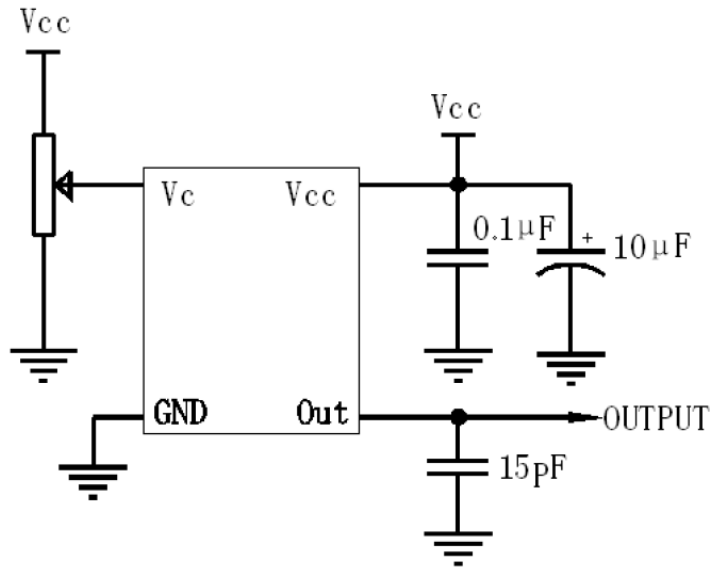

# Precision SMD VCTCXO

AST3TDA-0000-T

Request Samples



Check Inventory



ESD Sensitive



7.0 x 5.0 x 2.2 mm  
RoHS/RoHS II Compliant  
MSL Level = 3

## Reflow Profile [JEDEC J-STD-020]

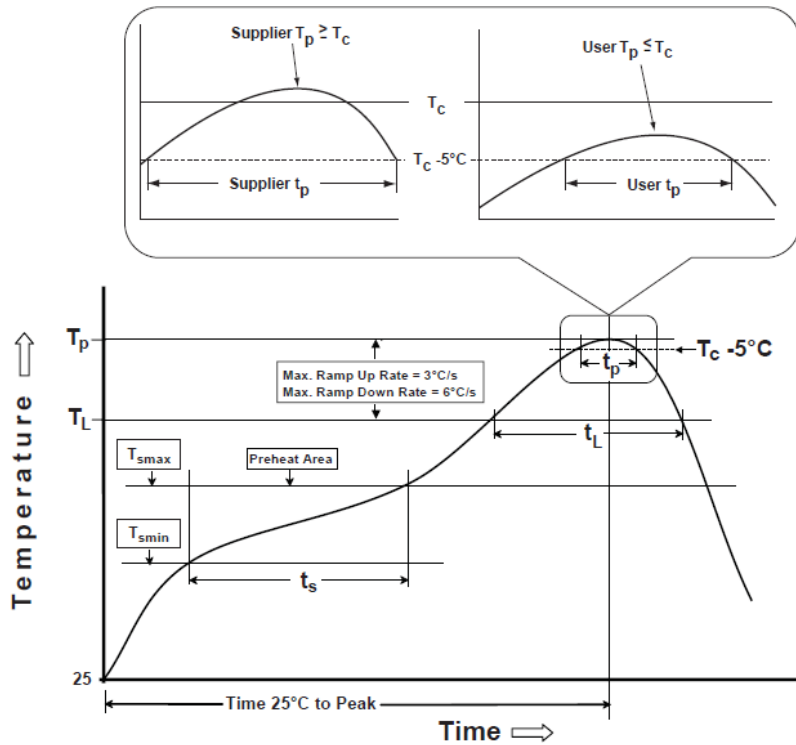

Table 1

### SnPb Eutectic Process Classification Temperatures ( $T_c$ )

Package Thickness	Volume mm <sup>3</sup> <350	Volume mm <sup>3</sup> ≥350
<2.5 mm	235 °C	220 °C
≥2.5 mm	220 °C	220 °C

Table 2

### Pb-Free Process Classification Temperatures ( $T_c$ )

Package Thickness	Volume mm <sup>3</sup> <350	Volume mm <sup>3</sup> 350-2000	Volume mm <sup>3</sup> >2000
<1.6 mm	260 °C	260 °C	260 °C
1.6 mm - 2.5 mm	260 °C	250 °C	245 °C
>2.5 mm	250 °C	245 °C	245 °C

Profile Feature	Sn-Pb Eutectic Assembly	Pb-Free Assembly
Preheat / soak		
Temperature minimum ( $T_{smin}$ )	100°C	150°C
Temperature maximum ( $T_{smax}$ )	150°C	200°C
Time ( $T_{smin}$ to $T_{smax}$ ) ( $t_s$ )	60 - 120 sec.	60 - 120 sec.
Average ramp-up rate ( $T_{smax}$ to $T_p$ )	3°C/sec. max	3°C/sec. max
Liquidous temperature ( $T_L$ )	183°C	217°C
Time at liquidous ( $t_L$ )	60 - 150 sec.	60 - 150 sec.
Peak package body temperature ( $T_p$ )*	see Table 1	see Table 2
Time ( $t_p$ )** within 5°C of the specified classification temperature ( $T_c$ )	20 sec.	30 sec.
Ramp-down rate ( $T_p$ to $T_{smax}$ )	6°C/sec. max	6°C/sec. max
Time 25°C to peak temperature	6 min. max	8 min. max
Reflow cycles	2 max	2 max

\*Tolerance for peak profile temperature ( $T_p$ ) is defined as a supplier minimum and a user maximum.

\*\*Tolerance for time at peak profile temperature ( $t_p$ ) is defined as supplier minimum and a user maximum.

# Precision SMD VCTCXO

AST3TDA-0000-T

Request Samples



Check Inventory



ESD Sensitive



7.0 x 5.0 x 2.2 mm  
RoHS/RoHS II Compliant  
MSL Level = 3

## Packaging

T5:500pcs/reel

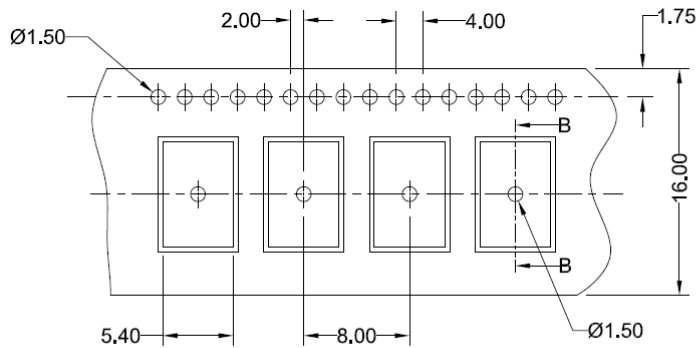

FEEDING (PULL) DIRECTION

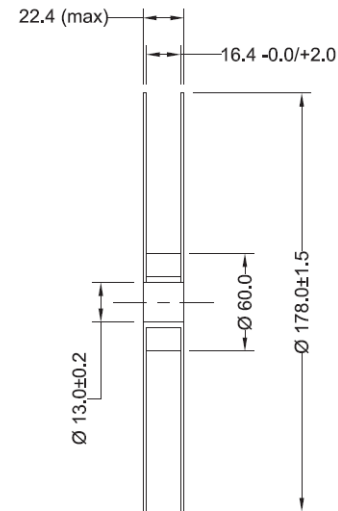
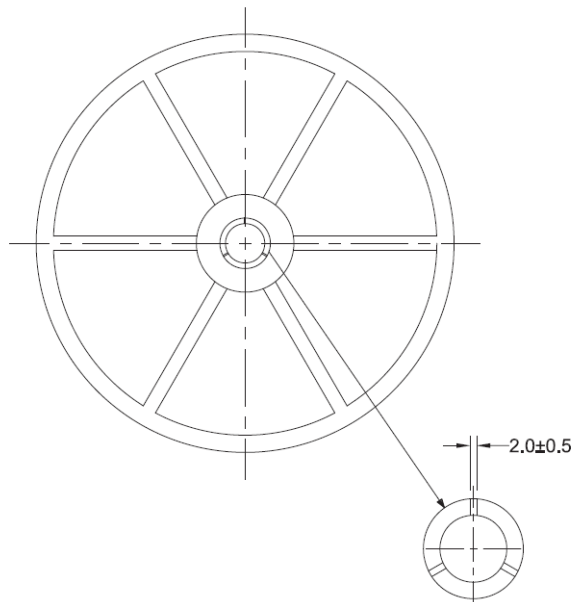
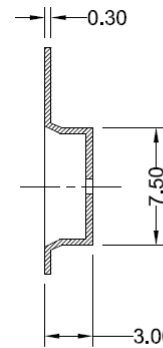

Dimensions: mm

**ATTENTION:** Abracon LLC's products are COTS – Commercial-Off-The-Shelf products; suitable for Commercial, Industrial and, where designated, Automotive Applications. Abracon's products are not specifically designed for Military, Aviation, Aerospace, Life-dependent Medical applications or any application requiring high reliability where component failure could result in loss of life and/or property. For applications requiring high reliability and/or presenting an extreme operating environment, written consent and authorization from Abracon LLC is required. Please contact Abracon LLC for more information.



5101 Hidden Creek Ln Spicewood TX 78669  
Phone: 512-371-6159 | Fax: 512-351-8858  
For terms and conditions of sales, please visit:  
[www.abracon.com](http://www.abracon.com)

REVISED: 03-14-22

ABRACON IS  
ISO9001-2015  
CERTIFIED