



soberton inc.

# EXCITER

## Acoustic Product Specification

Product Number: E-3304



Release | Revision: A/2018

### CONTENTS

This document contains the technical specifications for the exciter

#### Page 1

Specifications

Dimensions

Frequency Response

## Specifications

Specification	Unit	E-3304
AC Impedance	$\Omega$	4±15% at 1000Hz
Rated Input Power	Watt	3.0
Max Input Power	Watt	4.0
Resonant Frequency	Hz	640±20%
Frequency Range	Hz	F0~8.0KHz, average SPL±10dB
Output Sound Pressure Level	dB	99 ±3dB 1.0 Watt/10 cm, AVG. at 0.8, 1.0, 1.2, 1.5KHz
Operating Temperature	°C	-20°C ~ +50°C
Storage Temperature	°C	-40°C ~ +60°C
Dimension	mm	Ø 33.0 x H12.3
Distortion		3% maximum at 1000Hz, 3.0W
Polarity		Diaphragm shall move forward when a positive DC current is applied to the "+" or "Marked" terminal
Load Test		Audio Signal Generator at 3.46 Volt Total 48hrs and 20Hz ~ 20KHz resonant frequency
Abnormal Sound Test		Must be normal tested at 3.46 Volt sine wave

## Dimensions

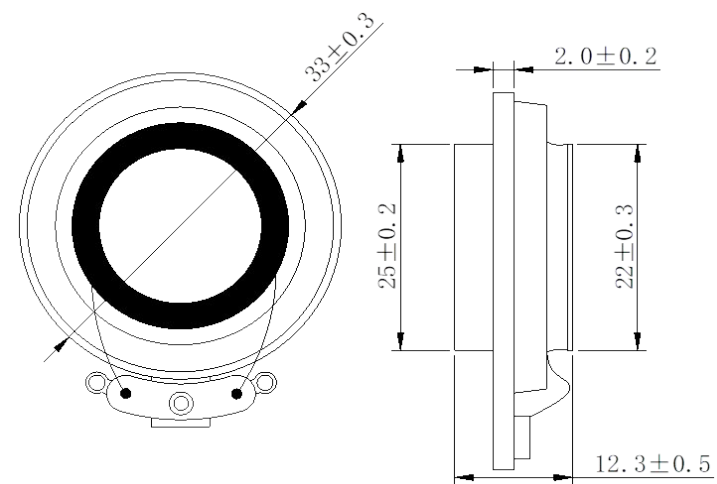

Unit: mm

## Frequency Response

