

TMC 83D 40A - Thermomagnetic device circuit breaker



1010289

<https://www.phoenixcontact.com/us/products/1010289>

Please be informed that the data shown in this PDF document is generated from our Online Catalog. Please find the complete data in the user documentation. Our General Terms of Use for Downloads are valid.

Thermomagnetic device circuit breaker, number of positions: 3, connection method: Screw, cross section: 1 mm²- 35 mm², AWG: 18 - 2, mounting type: DIN rail, Color: gray



Commercial Data

Item number	1010289
Packing unit	1 pc
Note	Made to Order (non-returnable)
Sales Key	CL08
Product Key	CLA125
GTIN	4055626482583
Weight per Piece (including packing)	222.222 g
Weight per Piece (excluding packing)	222.222 g
Customs tariff number	85362010
Country of origin	CN

TMC 83D 40A - Thermomagnetic device circuit breaker



1010289

<https://www.phoenixcontact.com/us/products/1010289>

Technical Data

Product properties

Type	DIN rail module, one-piece
Product type	Thermomagnetic device circuit breakers
Product family	TMC 8
Number of positions	3
Mechanical service life	20000

Electrical properties

Service life electrical	6000
-------------------------	------

General

Operating voltage	240 V AC (Delta)
Rated current I_N	40 A
Tripping method	TM (thermomagnetic)
Rated short-circuit switching capacity I_{cn}	10 kA (IC)
Fuse	D

Connection data

Tightening torque	... 2 Nm
Conductor cross section rigid	1 mm ² ... 35 mm ²
Cross section AWG	18 ... 2 (converted acc. to IEC)
Conductor cross section flexible	1 mm ² ... 35 mm ²
Connection method	Screw
Tightening torque, min	2 Nm
Conductor cross section flexible max.	35 mm ²
Conductor cross section, rigid max.	35 mm ²

Dimensions

Dimensional drawing	
Width	52.9 mm
Height	116 mm
Depth	65.7 mm

Material specifications

Color	gray
-------	------

Environmental and real-life conditions

Ambient conditions

TMC 83D 40A - Thermomagnetic device circuit breaker



1010289

<https://www.phoenixcontact.com/us/products/1010289>

Ambient temperature (operation)	-35 °C ... 70 °C
Humidity test	48 h, 95% RH, 40°C (IEC 60068-2-78)
Shock (operation)	30g (11 ms) (IEC 60068-2-11)
Vibration (operation)	±0.38 mm (10-57 Hz), 5g (57...500 Hz) (IEC 60068-2-6, Fc, sine)

Standards and regulations

Standards/specifications	UL 489
Standards/specifications	IEC 60947-2

Mounting

Mounting type	DIN rail
---------------	----------

Drawings

Diagram

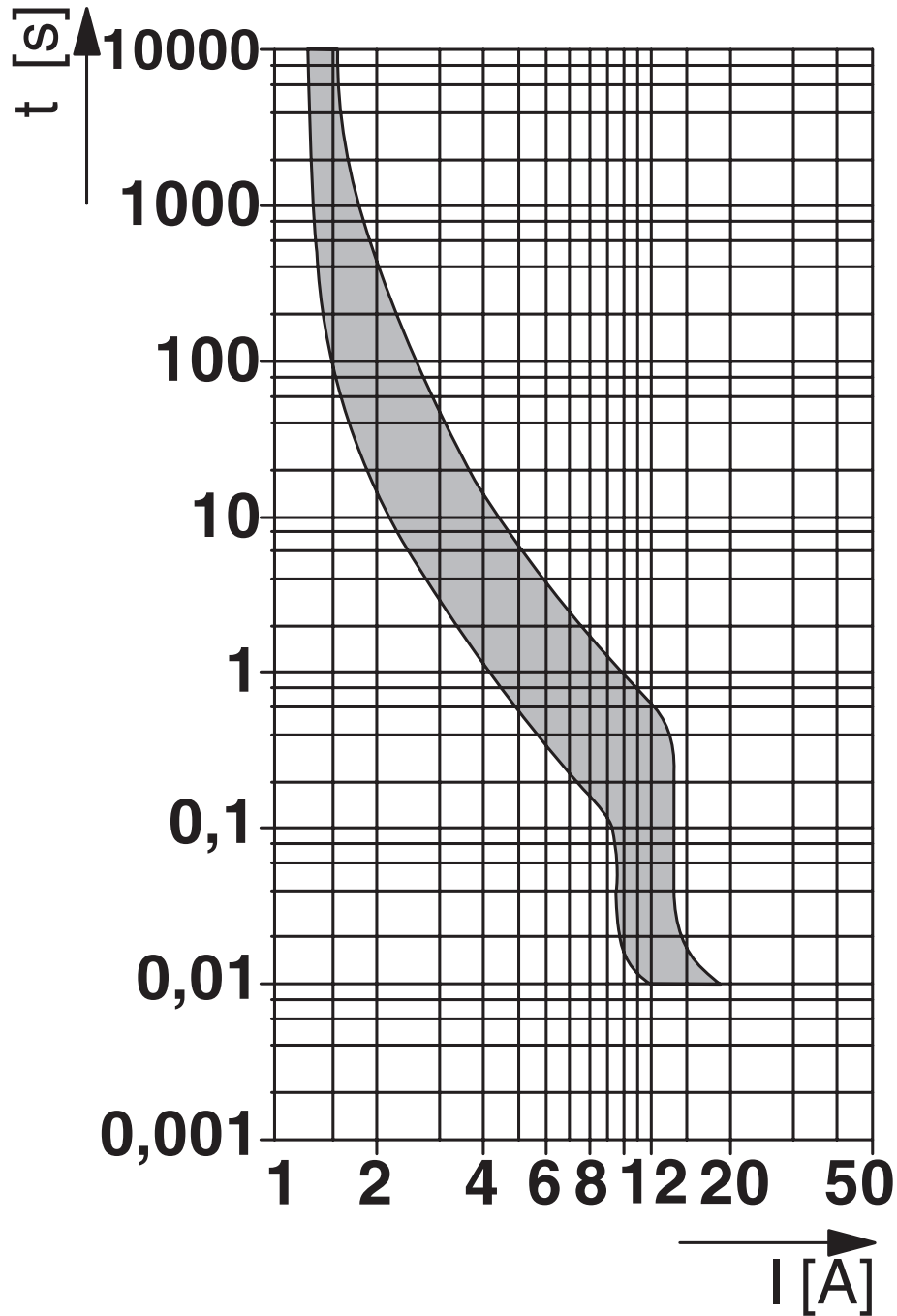

TMC 83D 40A - Thermomagnetic device circuit breaker



1010289

<https://www.phoenixcontact.com/us/products/1010289>

Dimensional drawing

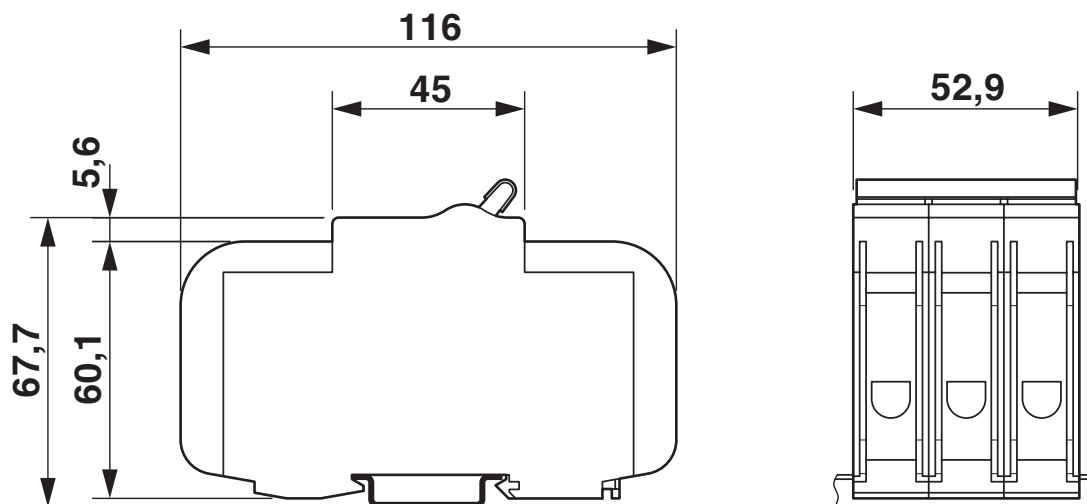

TMC 83D 40A - Thermomagnetic device circuit breaker



1010289

<https://www.phoenixcontact.com/us/products/1010289>

Approvals

 **UL Listed**
Approval ID: FILE E 320373

 **cUL Listed**
Approval ID: FILE E 320373

 **TÜV Rheinland**
Approval ID: R 50531587

TMC 83D 40A - Thermomagnetic device circuit breaker



1010289

<https://www.phoenixcontact.com/us/products/1010289>

Classifications

ECLASS

ECLASS-11.0	27141116
ECLASS-12.0	27141116
ECLASS-13.0	27250113

ETIM

ETIM 7.0	EC000899
----------	----------

UNSPSC

UNSPSC 21.0	39121410
-------------	----------

TMC 83D 40A - Thermomagnetic device circuit breaker



1010289

<https://www.phoenixcontact.com/us/products/1010289>

Environmental Product Compliance

REACH SVHC	Lead 7439-92-1
	Cadmium oxide 1306-19-0

TMC 83D 40A - Thermomagnetic device circuit breaker



1010289

<https://www.phoenixcontact.com/us/products/1010289>

Accessories

TMC 8 B3 80 57 C - Wiring bridge

2907996

<https://www.phoenixcontact.com/us/products/2907996>

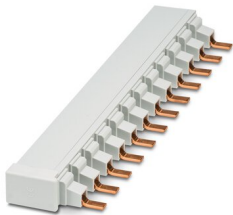

Bus bar for TMC 83... circuit breakers (three phase) 17.8 mm pitch, up to 57 positions. Rated for 80 A (end feed) 600 V AC/DC. UL 508 Listed for connection of UL 489 rated circuit breakers.

TMC 8 B3 80 48 CA - Wiring bridge

2907997

<https://www.phoenixcontact.com/us/products/2907997>

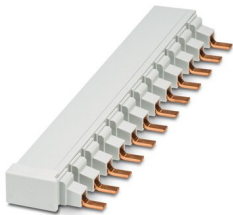

Bus bar for TMC 83... circuit breakers (three phase) with auxilliary switch. 17.8 mm pitch, up to 48 positions. Rated for 80 A (end feed) 600 V AC/DC. UL 508 Listed for connection of UL 489 rated circuit breakers.

TMC 83D 40A - Thermomagnetic device circuit breaker



1010289

<https://www.phoenixcontact.com/us/products/1010289>

TMC 8 B TERM PIN - Terminal adapter

2907998

<https://www.phoenixcontact.com/us/products/2907998>

Feeder terminal adapter for TMC 8..... circuit breaker bus bars. Rated for 1000 V AC/DC, 115 A. Wire range 14...2 AWG. UL Listed for connection to UL 489 rated circuit breakers.



TMC 8 B END CAP - Wiring bridge end cover

2907999

<https://www.phoenixcontact.com/us/products/2907999>

Protective end covers for TMC 8 bus bars



TMC 83D 40A - Thermomagnetic device circuit breaker



1010289

<https://www.phoenixcontact.com/us/products/1010289>

TMC 8 B BUS CAP - Protective cover

2908000

<https://www.phoenixcontact.com/us/products/2908000>

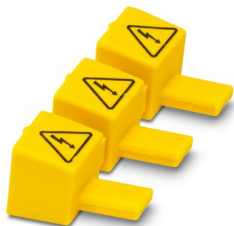

Protective covers for TMC 8 bus bars. Cuttable, three positions, yellow.

TMC 7/8 AUX - Thermomagnetic device circuit breaker

2908219

<https://www.phoenixcontact.com/us/products/2908219>



Thermomagnetic device circuit breaker, number of positions: 1, connection method: Screw, cross section: 1 mm²- 35 mm², AWG: 18 - 2, mounting type: Snaps on to side of circuit breaker, Color: gray

TMC 83D 40A - Thermomagnetic device circuit breaker



1010289

<https://www.phoenixcontact.com/us/products/1010289>

TMC 7/8 ALARM - Thermomagnetic device circuit breaker

2908220

<https://www.phoenixcontact.com/us/products/2908220>



Thermomagnetic device circuit breaker, number of positions: 1, connection method: Screw, cross section: 1 mm²- 35 mm², AWG: 18 - 2, mounting type: Snaps on to side of circuit breaker, Color: gray

TMC 7/8 12VDC SHNT - Thermomagnetic device circuit breaker

2908221

<https://www.phoenixcontact.com/us/products/2908221>



Thermomagnetic device circuit breaker, number of positions: 1, connection method: Screw, cross section: 1 mm²- 35 mm², AWG: 18 - 2, mounting type: Snaps on to side of circuit breaker, Color: gray

TMC 83D 40A - Thermomagnetic device circuit breaker



1010289

<https://www.phoenixcontact.com/us/products/1010289>

TMC 7/8 24VDC SHNT - Thermomagnetic device circuit breaker

2908222

<https://www.phoenixcontact.com/us/products/2908222>



Thermomagnetic device circuit breaker, number of positions: 1, connection method: Screw, cross section: 1 mm²- 35 mm², AWG: 18 - 2, mounting type: Snaps on to side of circuit breaker, Color: gray

TMC 7/8 48VDC SHNT - Thermomagnetic device circuit breaker

2908224

<https://www.phoenixcontact.com/us/products/2908224>



Thermomagnetic device circuit breaker, number of positions: 1, connection method: Screw, cross section: 1 mm²- 35 mm², AWG: 18 - 2, mounting type: Snaps on to side of circuit breaker, Color: gray

TMC 83D 40A - Thermomagnetic device circuit breaker



1010289

<https://www.phoenixcontact.com/us/products/1010289>

TMC 7/8 125VDC SHNT - Thermomagnetic device circuit breaker

2908225

<https://www.phoenixcontact.com/us/products/2908225>



Thermomagnetic device circuit breaker, number of positions: 1, connection method: Screw, cross section: 1 mm²- 35 mm², AWG: 18 - 2, mounting type: Snaps on to side of circuit breaker, Color: gray

TMC 7/8 120VAC SHNT - Thermomagnetic device circuit breaker

2908226

<https://www.phoenixcontact.com/us/products/2908226>



Thermomagnetic device circuit breaker, number of positions: 1, connection method: Screw, cross section: 1 mm²- 35 mm², AWG: 18 - 2, mounting type: Snaps on to side of circuit breaker, Color: gray

TMC 83D 40A - Thermomagnetic device circuit breaker



1010289

<https://www.phoenixcontact.com/us/products/1010289>

TMC 7/8 240VAC SHNT - Thermomagnetic device circuit breaker

2908227

<https://www.phoenixcontact.com/us/products/2908227>



Thermomagnetic device circuit breaker, number of positions: 1, connection method: Screw, cross section: 1 mm²- 35 mm², AWG: 18 - 2, mounting type: Snaps on to side of circuit breaker, Color: gray

TMC 7/8 277VAC SHNT - Thermomagnetic device circuit breaker

2908228

<https://www.phoenixcontact.com/us/products/2908228>



Thermomagnetic device circuit breaker, number of positions: 1, connection method: Screw, cross section: 1 mm²- 35 mm², AWG: 18 - 2, mounting type: Snaps on to side of circuit breaker, Color: gray

TMC 83D 40A - Thermomagnetic device circuit breaker



1010289

<https://www.phoenixcontact.com/us/products/1010289>

EML (10X4)R - Label

0815583

<https://www.phoenixcontact.com/us/products/0815583>



Label, Roll, white, unlabeled, can be labeled with: THERMOMARK E.300 (D)/600 (D), THERMOMARK ROLL 2.0, THERMOMARK ROLL, THERMOMARK ROLL X1, THERMOMARK ROLLMASTER 300/600, THERMOMARK X1.2, mounting type: adhesive, lettering field size: 10 x 4 mm, Number of individual labels: 10000

TML (104X3,8)R - Marker strip

0801833

<https://www.phoenixcontact.com/us/products/0801833>



Marker strip, Roll, white, unlabeled, can be labeled with: THERMOMARK E.300 (D)/600 (D), THERMOMARK ROLL 2.0, THERMOMARK ROLL, THERMOMARK ROLL X1, THERMOMARK ROLLMASTER 300/600, THERMOMARK X1.2, mounting type: adhesive, for terminal block width: 104 mm, lettering field size: 104 x 3.8 mm, Number of individual labels: 2500

Phoenix Contact 2023 © - all rights reserved
<https://www.phoenixcontact.com>

Phoenix Contact USA
586 Fulling Mill Road
Middletown, PA 17057, United States
(+717) 944-1300
info@phoenixcon.com