

APPROVAL SHEET



*Contents in this sheet are subject to change without prior notice.

FEATURES

1. General purpose chip ferrite power inductor for high integration electronics device.
2. Ceramic structure provides high reliability \ high productivity.
3. RoHS compliance.

APPLICATIONS

1. EMI solution for I/O ports.
2. RF choke for DC power supplying to LNA or external antenna.

SHAPE and DIMENSION

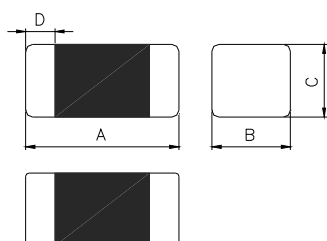

Chip Size	
A	1.60±0.15
B	0.80±0.15
C	0.80±0.15
D	0.30±0.20

Units: mm

Ordering Information

WL	FI	1608	Z0	M	R22	T	B
Product Code	Series	Dimensions	Series extension	Tolerance	Value	Packing Code	
WL: Inductor	FI : Ferrite Chip Inductor	1.6 * 0.8 mm 1608 :EIA 0603	Z0 :STD	M: ±20%	R22 = 0.22 uH 2R2 = 2.2 uH 100 = 10 uH	T = 7" Paper Tape P = 7" Plastic Tape	B:STD

Electrical Characteristics

● WLF11608 series

Walsin Part Number	Inductance (uH)	Tolerance	Q	Test Frequency (MHz)	SRF (MHz) min.	DC Resistance (Ω) max.	Rated Current (mA) max.
WLF11608Z0M47NTB	0.047	M	10	60mV / 50MHz	260	0.30	50
WLF11608Z0M68NTB	0.068	M	10	60mV / 50MHz	250	0.30	50
WLF11608Z0M82NTB	0.082	M	10	60mV / 50MHz	245	0.30	50
WLF11608Z0MR10TB	0.10	M	15	60mV / 25MHz	240	0.50	50
WLF11608Z0MR12TB	0.12	M	15	60mV / 25MHz	205	0.50	50
WLF11608Z0MR15TB	0.15	M	15	60mV / 25MHz	180	0.60	50
WLF11608Z0MR18TB	0.18	M	15	60mV / 25MHz	165	0.60	50
WLF11608Z0MR22TB	0.22	M	15	60mV / 25MHz	150	0.80	50
WLF11608Z0MR27TB	0.27	M	15	60mV / 25MHz	136	0.80	50
WLF11608Z0MR33TB	0.33	M	15	60mV / 25MHz	125	0.85	35
WLF11608Z0MR39TB	0.39	M	15	60mV / 25MHz	110	1.00	35
WLF11608Z0MR47TB	0.47	M	15	60mV / 25MHz	105	1.35	35
WLF11608Z0MR56TB	0.56	M	15	60mV / 25MHz	95	1.55	35
WLF11608Z0MR68TB	0.68	M	15	60mV / 25MHz	80	1.70	35
WLF11608Z0MR82TB	0.82	M	15	60mV / 25MHz	75	2.10	35
WLF11608Z0M1R0TB	1.0	M	30	60mV / 10MHz	70	0.60	25
WLF11608Z0M1R5TB	1.5	M	30	60mV / 10MHz	55	0.80	25
WLF11608Z0M1R8TB	1.8	M	30	60mV / 10MHz	50	0.95	25
WLF11608Z0M2R2TB	2.2	M	30	60mV / 10MHz	45	1.15	15
WLF11608Z0M3R3TB	3.3	M	30	60mV / 10MHz	38	1.55	15
WLF11608Z0M4R7TB	4.7	M	30	60mV / 10MHz	33	2.10	15
WLF11608Z0M100TB	10	M	30	60mV / 2MHz	17	2.55	15

NOTE :TOLERANCE M= ±20%

Characteristic Curve

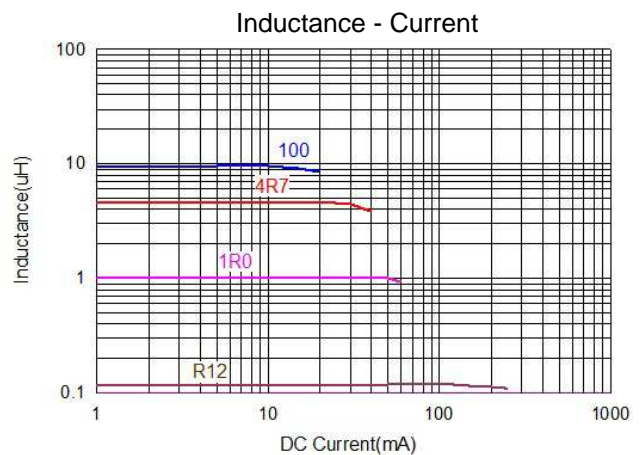
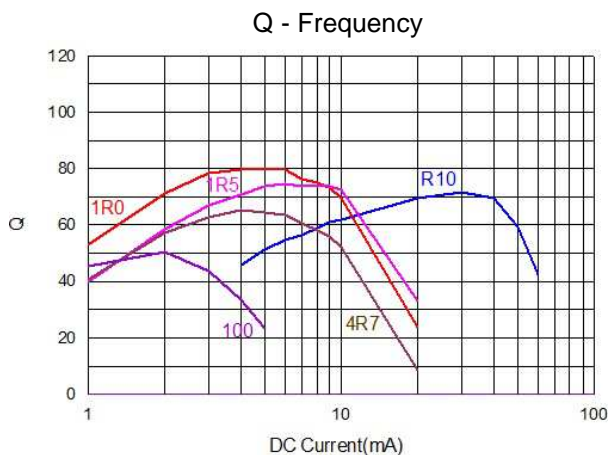

Test condition & Requirements

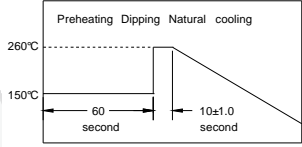
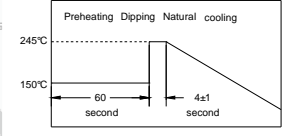
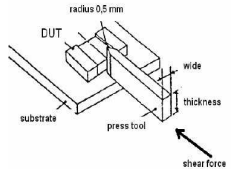
Item	Performance	Test Condition
Operating Temperature	-40~+105°C (Including self-temperature rise)	--
Transportation Storage Temperature	-40~+105°C (on board)	For long storage conditions, please see the Application Notice
Impedance (Z)	Refer to standard electrical characteristics list	Agilent4291
Inductance (Ls)		Agilent E4991
Q Factor		Agilent4287
DC Resistance		Agilent16192
Rated Current		Agilent 4338
Temperature Rise Test	Rated Current < 1A ΔT 20°C Max Rated Current ≥ 1A ΔT 40°C Max	1. Applied the allowed DC current. 2. Temperature measured by digital surface thermometer.
Resistance to Soldering Heat	Appearance : No damage. Impedance : within±15% of initial value Inductance : within±10% of initial value Q : Shall not exceed the specification value. RDC : within ±15% of initial value and shall not exceed the specification value	Preheat: 150°C,60sec. Solder: Sn99.5%-Cu0.5% Solder temperature: 260±5°C Flux for lead free: Rosin. 9.5% Temperature ramp/immersion and immersion rate: 25±6 mm/s Dip time: 10±1sec. Depth: completely cover the termination. 
Solderability	More than 95% of the terminal electrode should be covered with solder. 	Preheat: 150°C,60sec. Solder: Sn99.5%-Cu0.5% Solder temperature: 245±5°C Flux for lead free: Rosin. 9.5% Depth: completely cover the termination. Dip time: 4±1sec.
Terminal strength	Appearance : No damage. Impedance : within±15% of initial value Inductance : within±10% of initial value Q : Shall not exceed the specification value. RDC : within ±15% of initial value and shall not exceed the specification value 	Preconditioning: Run through IR reflow for 2 times.(IPC/JEDEC J-STD-020D Classification Reflow Profiles) Component mounted on a PCB apply a force (>0805:1kg <=0805:0.5kg)to the side of a device being tested. This force shall be applied for 60 +1 seconds. Also the force shall be applied gradually as not to shock the component being tested.
Bending	Appearance : No damage. Impedance : within±10% of initial value Inductance : within±10% of initial value Q : Shall not exceed the specification value. RDC : within ±15% of initial value and shall not exceed the specification value	Shall be mounted on a FR4 substrate of the following dimensions:>=0805:40x100x1.2mm <0805:40x100x0.8mm Bending depth:>=0805:1.2mm <0805:0.8mm Duration of 10 sec for a min.
Vibration Test	Appearance : No damage. Impedance : within±15% of initial value Inductance : within±10% of initial value Q : Shall not exceed the specification value. RDC : within ±15% of initial value and shall not exceed the specification value	Preconditioning: Run through IR reflow for 2 times.(IPC/JEDEC J-STD-020D Classification Reflow Profiles) Oscillation Frequency: 10~2K~10Hz for 20 minutes Equipment : Vibration checker Total Amplitude:1.52mm±10% Testing Time : 12 hours(20 minutes, 12 cycles each of 3 orientations) °

Shock	Appearance : No damage. Impedance : within±15% of initial value Inductance : within±10% of initial value Q : Shall not exceed the specification value. RDC : within ±15% of initial value and shall not exceed the specification value	Test condition:													
		<table border="1"> <thead> <tr> <th>Type</th> <th>Peak Value (g's)</th> <th>Normal duration (D) (ms)</th> <th>Wave form</th> <th>Velocity change (Vj)ft/sec</th> </tr> </thead> <tbody> <tr> <td>SMD</td> <td>1,500</td> <td>0.5</td> <td>Half-sine</td> <td>15.4</td> </tr> <tr> <td>Lead</td> <td>100</td> <td>6</td> <td>Half-sine</td> <td>12.3</td> </tr> </tbody> </table>	Type	Peak Value (g's)	Normal duration (D) (ms)	Wave form	Velocity change (Vj)ft/sec	SMD	1,500	0.5	Half-sine	15.4	Lead	100	6
Type	Peak Value (g's)	Normal duration (D) (ms)	Wave form	Velocity change (Vj)ft/sec											
SMD	1,500	0.5	Half-sine	15.4											
Lead	100	6	Half-sine	12.3											
Item	Performance	Test Condition													
Life test	Appearance: no damage. Impedance: within±15%of initial value. Inductance: within±10%of initial value. Q : Shall not exceed the specification value. RDC : within ±15% of initial value and shall not exceed the specification value	Preconditioning: Run through IR reflow for 2 times.(IPC/JEDEC J-STD-020D Classification Reflow Profiles) Temperature: 125±2°C (bead), 85±2°C (inductor) Applied current: rated current. Duration: 1000±12hrs. Measured at room temperature after placing for 24±2 hrs.													
Load Humidity	Impedance: within±15%of initial value. Inductance: within±10%of initial value. Q : Shall not exceed the specification value. RDC : within ±15% of initial value and shall not exceed the specification value	Preconditioning: Run through IR reflow for 2 times.(IPC/JEDEC J-STD-020D Classification Reflow Profiles) Humidity: 85±2%R.H. Temperature: 85±2°C. Duration: 1000hrs Min. with 100% rated current. Measured at room temperature after placing for 24±2 hrs.													
Thermal shock	Appearance: no damage. Impedance: within±15%of initial value. Inductance: within±10%of initial value. Q : Shall not exceed the specification value. RDC : within ±15% of initial value and shall not exceed the specification value	Preconditioning: Run through IR reflow for 2 times.(IPC/JEDEC J-STD-020D Classification Reflow Profiles) Condition for 1 cycle Step1: -40±2°C 30±5 min. Step2: 25±2°C ≤0.5min Step3: +105±2°C 30±5min. Number of cycles: 500 Measured at room temperature after placing for 24±2 hrs.													
Insulation Resistance	IR>1GΩ	Chip Inductor Only Test Voltage:100±10%V for 30Sec.													

****Derating Curve**

For the ferrite chip bead which withstanding current over 1.5A, as the operating temperature over 85°C, the derating current information is necessary to consider with. For the detail derating of current, please refer to the Derated Current vs. Operating Temperature curve.

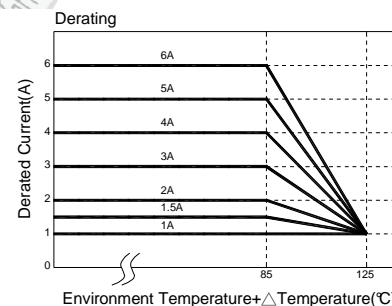

Soldering and Mounting

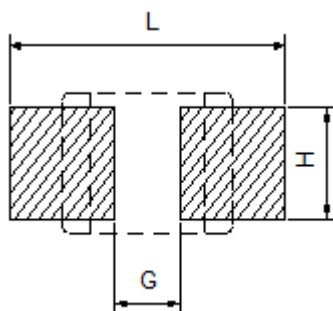

	L (mm)	G (mm)	H (mm)
WLF11608	2.60	0.60	0.80

Soldering

Mildly activated rosin fluxes are preferred. The terminations are suitable for re-flow soldering systems. If hand soldering cannot be avoided, the preferred technique is the utilization of hot air soldering tools.

Note. If wave soldering is used, there will be some risk.
Re-flow soldering temperatures below 240 degrees, there will be non-wetting risk

Lead Free Solder re-flow

Recommended temperature profiles for lead free re-flow soldering in Figure 1. (Referred to J-STD-020C)

Soldering Iron:

Products attachment with a soldering iron is discouraged due to the inherent process control limitations. If a soldering iron must be employed the following precautions are recommended. for Iron Soldering in Figure 2.

- Preheat circuit and products to 150°C
- 350°C tip temperature (max)
- Never contact the ceramic with the iron tip
- 1.0mm tip diameter (max)
- Use a 20 watt soldering iron with tip diameter of 1.0mm
- Limit soldering time to 4~5sec.

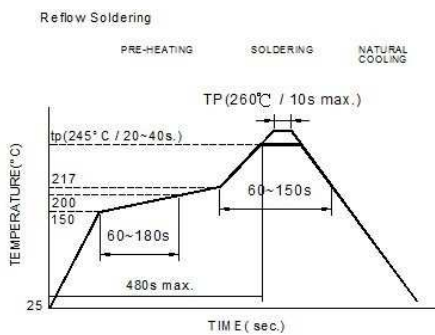

Reflow times: 3 times max.
Fig.1

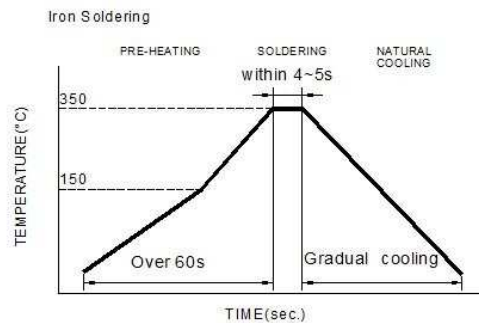

Iron Soldering times : 1 times max.
Fig.2

Packaging Specification

■ Material of taping is paper

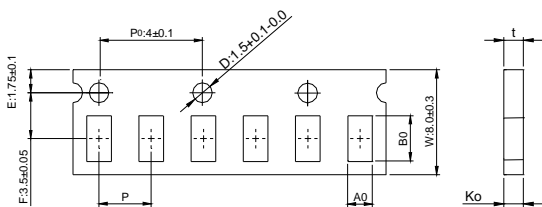

Size	Bo(mm)	Ao(mm)	Ko(mm)	P(mm)	t(mm)
060303	0.70±0.06	0.40±0.06	0.45max	2.0±0.05	0.45max
100505	1.12±0.03	0.62±0.03	0.60±0.03	2.0±0.05	0.60±0.03

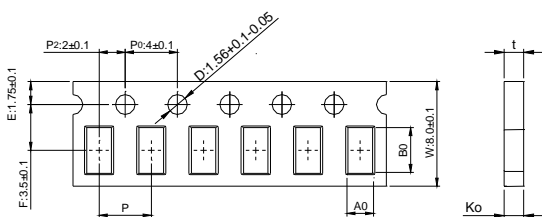

Size	Bo(mm)	Ao(mm)	Ko(mm)	P(mm)	t(mm)
160808	1.80±0.05	0.96+0.05/-0.03	0.95±0.05	4.0±0.10	0.95±0.05
201209	2.10±0.05	1.30±0.05	0.95±0.05	4.0±0.10	0.95±0.05

■ Material of taping is plastic

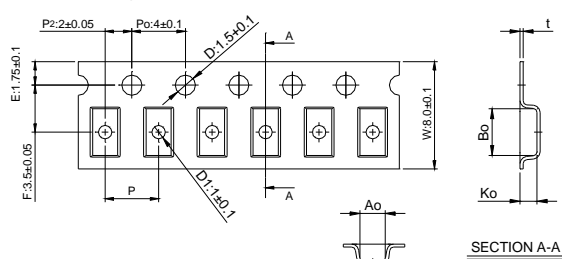

Size	Bo(mm)	Ao(mm)	Ko(mm)	P(mm)	t(mm)	D1(mm)
201212	2.10±0.10	1.28±0.10	1.28±0.10	4.0±0.10	0.22±0.05	1.0±0.10
321611	3.35±0.10	1.75±0.10	1.25±0.10	4.0±0.10	0.23±0.05	1.0±0.10
322513	3.42±0.10	2.77±0.10	1.55±0.10	4.0±0.10	0.22±0.05	1.0±0.10
321609	3.40±0.10	1.77±0.10	1.04±0.10	4.0±0.10	0.22±0.05	1.0±0.10

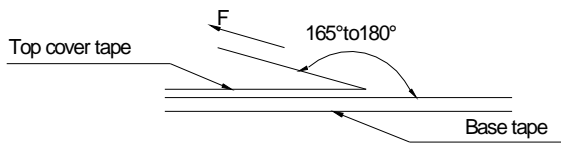

The force for tearing off cover tape is 15 to 60 grams in the arrow direction under the following conditions

Room Temp. (°C)	Room Humidity (%)	Room atm (hPa)	Tearing Speed mm/min
5~35	45~85	860~1060	300

Products meet IPC/JEDEC J-STD-020D standard-MSL, level 1.

Quantity per reel : 4k pcs / reel

