

# LM49270 Boomer® Audio Power Amplifier Series Filterless 2.2W Stereo Class D Audio Subsystem with OCL Headphone Amplifier, 3D Enhancement, and Headphone Sense

Check for Samples: [LM49270](#)

## FEATURES

- Stereo Filterless Class D Amplifier
- Selectable OCL/CC Headphone Amplifier
- Headphone Sense Ability
- TI's 3D Enhancement
- RF Suppression
- I<sup>2</sup>C Control Interface
- 32-Step Digital Volume Control
- 6 Operating Modes
- Output Short Circuit Protection and Thermal Shutdown Protection
- Minimum External Components
- Click and Pop Suppression
- Micro-Power Shutdown
- Independent Speaker and Headphone Volume Controls
- Available in Space-Saving 28 Pin WQFN Package

- Headphone Amplifier:
  - $R_L = 16\Omega$ , THD+N =  $\leq 1\%$  155 mW
  - $R_L = 32\Omega$ , THD+N =  $\leq 1\%$  90 mW
- Shutdown Current 0.02 $\mu$ A

## DESCRIPTION

The LM49270 is a fully integrated audio subsystem designed for stereo multimedia applications. The LM49270 combines a 2.2W stereo Class D amplifier with a 155mW stereo headphone amplifier, volume control, headphone sense, and TI's unique 3D sound enhancement into a single device. The LM49270 uses flexible I<sup>2</sup>C control interface for multiple application requirements.

The filterless stereo class D amplifiers delivers 2.2W/channel into a 4 $\Omega$  load with less than 10% THD+N with a 5V supply. The headphone amplifier features Output Capacitor-less (OCL) architecture that eliminates the output coupling capacitors required by traditional headphone amplifiers.

The IC features a headphone sense input (HPS) that automatically detects the presence of a headphone and configures the device accordingly. The LM49270 can automatically switch from OCL headphone output to a line driver output. If the VOC pin is pulled to GND, the VOC amplifier is disabled and the VOC pin is internally set to GND. This feature allows the LM49270 to be used as a line driver in OCL mode without a GND conflict on the headphone jack sleeve. Additionally, the headphone amplifier can be configured as capacitively coupled (CC).

The LM49270 features a 32 step volume control for the headphone and stereo outputs. The device mode select and volume are controlled through an I<sup>2</sup>C compatible interface.

Output short circuit and thermal shutdown protection prevent the device from being damaged during fault conditions. Superior click and pop suppression eliminates audible transients on power-up/down and during shutdown. The LM49270 is available in a space saving 28-pin, 5x5mm WQFN package.

## APPLICATIONS

- Portable DVD Players
- Smart Phones
- PDAs
- Laptops

## KEY SPECIFICATIONS

- Stereo Class D Amplifier Efficiency:
  - $V_{DD} = 3.3V$ , 450mW/Ch into 8 $\Omega$  84%
  - $V_{DD} = 5V$ , 1W/Ch into 8 $\Omega$  84%
- Quiescent Power Supply Current,  $V_{DD} = 3.3V$ 
  - Speaker Mode 5.5 mA
  - Headphone Mode (OCL) 4 mA
- Power Output/Channel,  $V_{DD} = 5V$ 
  - Class D Speaker Amplifier:
    - $R_L = 4\Omega$ , THD+N =  $\leq 10\%$  2.3 W
    - $R_L = 8\Omega$ , THD+N =  $\leq 1\%$  106 W



Please be aware that an important notice concerning availability, standard warranty, and use in critical applications of Texas Instruments semiconductor products and disclaimers thereto appears at the end of this data sheet.

All trademarks are the property of their respective owners.



These devices have limited built-in ESD protection. The leads should be shorted together or the device placed in conductive foam during storage or handling to prevent electrostatic damage to the MOS gates.

### Typical Application

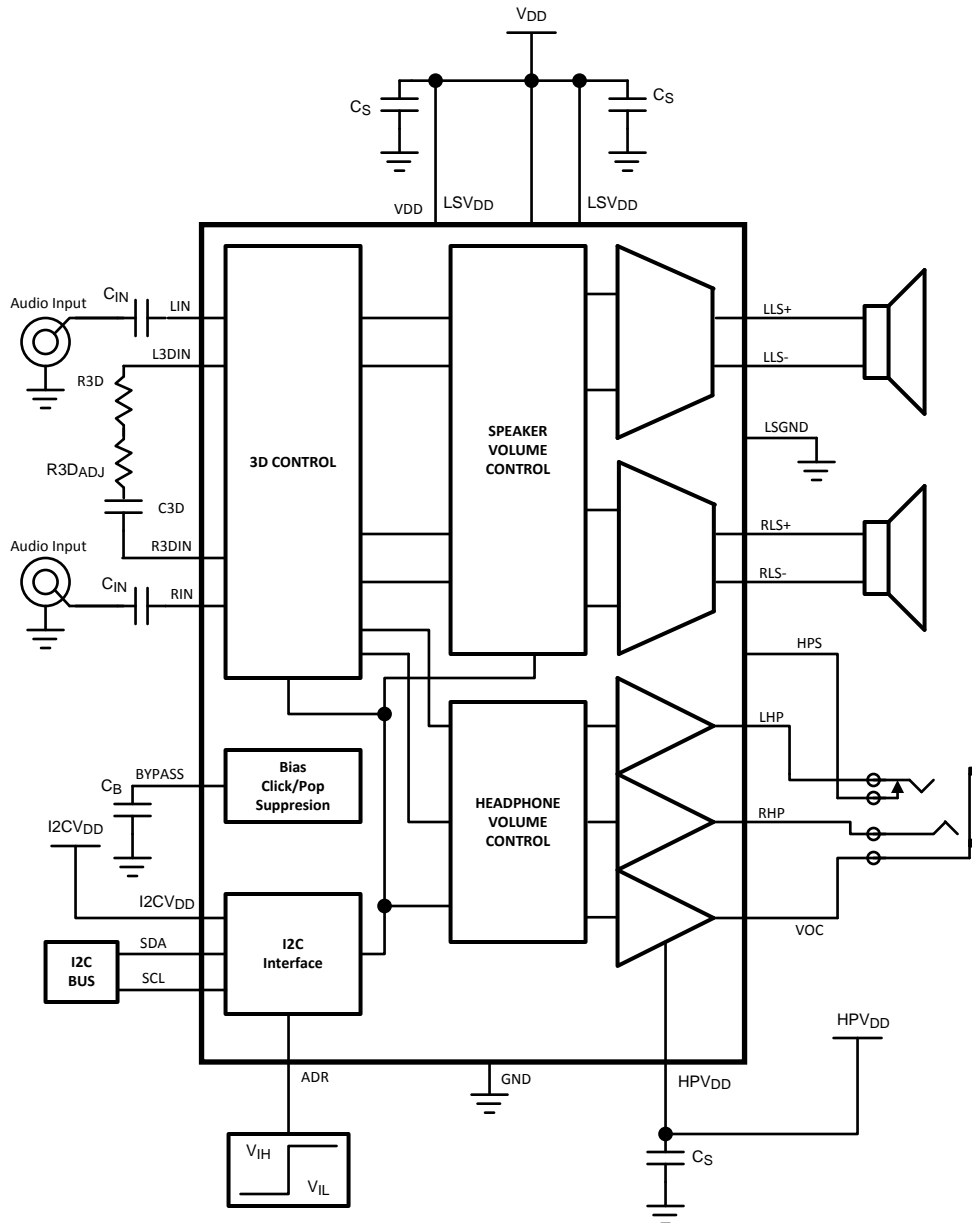
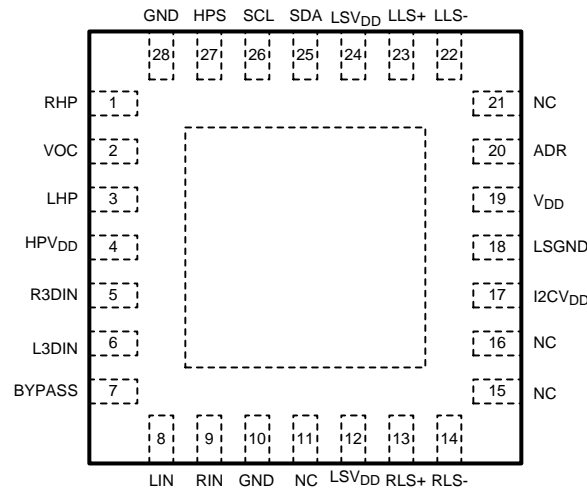

Figure 1. Typical Audio Amplifier Application Circuit

Connection Diagram



**Figure 2. WQFN Package  
5mm x 5mm x 0.8mm  
Top View  
See Package Number RSG0028A**

Pin Descriptions

PIN	NAME	DESCRIPTION
1	RHP	Right channel headphone output
2	VOC	VDD/2 buffer output
3	LHP	Left channel headphone output
4	HPV <sub>DD</sub>	Headphone supply input
5	R3DIN	Right channel 3D input
6	L3DIN	Left channel 3D input
7	BYPASS	Bias bypass
8	LIN	Left channel input
9	RIN	Right channel input
10	GND	Analog ground
11	NC	No connect
12	LSV <sub>DD</sub>	Speaker supply voltage input
13	RLS+	Right channel non-inverting speaker output
14	RLS-	Right channel inverting speaker output
15	NC	No connect
16	NC	No connect
17	I2CV <sub>DD</sub>	I2C supply voltage input
18	LSGND	Speaker ground
19	V <sub>DD</sub>	Power supply
20	ADR	Address
21	NC	No connect
22	LLS-	Left channel inverting speaker output
23	LLS+	Left channel non-inverting speaker output
24	LSV <sub>DD</sub>	Speaker supply voltage input
25	SDA	Serial data input
26	SCL	Serial clock input
27	HPS	Headphone sense input

### Pin Descriptions (continued)

PIN	NAME	DESCRIPTION
28	GND	Headphone ground

### Absolute Maximum Ratings <sup>(1)(2)(3)</sup>

Supply Voltage <sup>(1)</sup>	6.0V
Storage Temperature	-65°C to +150°C
Input Voltage	-0.3V to V <sub>DD</sub> +0.3V
Power Dissipation <sup>(4)</sup>	Internally Limited
ESD Susceptibility <sup>(5)</sup>	2000V
ESD Susceptibility <sup>(6)</sup>	200V
Junction Temperature (T <sub>JMAX</sub> )	150°C
Thermal Resistance	$\theta_{JA}$ 35.1°C/W

- (1) All voltages are measured with respect to the ground pin, unless otherwise specified.
- (2) *Absolute Maximum Ratings* indicate limits beyond which damage to the device may occur. *Operating Ratings* indicate conditions for which the device is functional, but do not ensure specific performance limits. *Electrical Characteristics* state DC and AC electrical specifications under particular test conditions which specify performance limits. This assumes that the device is within the Operating Ratings. Specifications are not ensured for parameters where no limit is given, however, the typical value is a good indication of device performance.
- (3) If Military/Aerospace specified devices are required, please contact the TI Sales Office/ Distributors for availability and specifications.
- (4) The maximum power dissipation must be derated at elevated temperatures and is dictated by T<sub>JMAX</sub>,  $\theta_{JA}$ , and the ambient temperature, T<sub>A</sub>. The maximum allowable power dissipation is P<sub>DMAX</sub> = (T<sub>JMAX</sub> - T<sub>A</sub>) /  $\theta_{JA}$  or the number given in Absolute Maximum Ratings, whichever is lower. For the LM49270 see power derating currents for more information.
- (5) Human body model, 100pF discharged through a 1.5k $\Omega$  resistor.
- (6) Machine Model, 220pF–240pF discharged through all pins.

### Operating Ratings <sup>(1)</sup>

Temperature Range	T <sub>MIN</sub> ≤ T <sub>A</sub> ≤ T <sub>MAX</sub>	-40°C ≤ T <sub>A</sub> ≤ 85°C
Supply Voltage (V <sub>DD</sub> , LSV <sub>DD</sub> , HPV <sub>DD</sub> )		2.4V ≤ V <sub>DD</sub> ≤ 5.5V
I <sup>2</sup> C Voltage (I <sup>2</sup> CV <sub>DD</sub> )		2.4V ≤ I <sup>2</sup> CV <sub>DD</sub> ≤ 5.5V

- (1) All voltages are measured with respect to the ground pin, unless otherwise specified.

**Electrical Characteristics  $V_{DD} = 3.3V$** 

(1) The following specifications apply for Headphone:  $A_V = 0dB$ ,  $R_{L(HP)} = 32\Omega$ ; for Loudspeakers:  $A_V = 6dB$ ,  $R_{L(SP)} = 15\mu H + 8\Omega + 15\mu H$ ,  $f = 1kHz$ , unless otherwise specified. Limits apply for  $T_A = 25^\circ C$ .

Symbol	Parameter	Conditions	LM49270		Units (Limits)
			Typical <sup>(2)</sup>	Limit <sup>(3) (4)</sup>	
$I_{DD}$	Supply Current	$V_{IN} = 0$ , $R_L =$ No Load, Both channels active	5.5	7.6	mA (max)
		Speaker ON, HP OFF	3	4.7	mA (max)
		Speaker OFF, CC HP ON Speaker OFF, OCL HP ON	4	5.75	mA (max)
$I_{SD}$	Shutdown Supply Current		0.02	2	$\mu A$ (max)
$V_{OS}$	Output Offset Voltage	Headphone	10	25	mV (max)
		Speaker	10	60	mV (max)
$P_{OUT}$	Output Power	Speaker Mode, $f = 1kHz$			
		THD+N = 1% $R_L = 4\Omega$ $R_L = 8\Omega$	700 450	400	mW mW (min)
		THD+N = 10% $R_L = 4\Omega$ $R_L = 8\Omega$	870 560		mW mW
		CC Headphone Mode, $f = 1kHz$			
		THD+N = 1% $R_L = 16\Omega$ $R_L = 32\Omega$	60 36	30	mW mW (min)
		THD+N = 10% $R_L = 16\Omega$ $R_L = 32\Omega$	74 55		mW mW
		OCL Headphone Mode, $f = 1kHz$			
		THD+N = 1% $R_L = 16\Omega$ $R_L = 32\Omega$	60 36	30	mW mW (min)
		THD+N = 10% $R_L = 16\Omega$ $R_L = 32\Omega$	73 55		mW mW
		THD+N	Total Harmonic Distortion + Noise	Speaker Mode, $f = 1kHz$ $P_{OUT} = 100mW$ , $R_L = 8\Omega$	0.02
CC Headphone Mode, $f = 1kHz$ $P_{OUT} = 12mW$ , $R_L = 32\Omega$	0.015				%
OCL Headphone Mode, $f = 1kHz$ $P_{OUT} = 12mW$ , $R_L = 32\Omega$	0.02				%
$e_N$	Noise	Speaker Mode, A-Wtg, Input Referred	47		$\mu V$
		CC Headphone Mode, A-Wtg, Input Referred	10		$\mu V$
		OCL Headphone Mode, A-Wtg, Input Referred	11		$\mu V$
$\eta$	Efficiency	Speaker Mode $R_L = 8\Omega$	84		%
Xtalk	Crosstalk	Speaker Mode, $f = 1kHz$ , $V_{IN} = 1V_{p-p}$	71		dB
		CC Headphone Mode, $f = 1kHz$ , $V_{IN} = 1V_{p-p}$	70		dB
		OCL Headphone Mode, $f = 1kHz$ , $V_{IN} = 1V_{p-p}$	55		dB

(1) All voltages are measured with respect to the ground pin, unless otherwise specified.

(2) Typicals are measured at  $25^\circ C$  and represent the parametric norm.

(3) Limits are specified to AOQL (Average Outgoing Quality Level).

(4) Data sheet min and max specification limits are specified by design, test, or statistical analysis.

### Electrical Characteristics $V_{DD} = 3.3V$ (continued)

(1) The following specifications apply for Headphone:  $A_V = 0dB$ ,  $R_{L(HP)} = 32\Omega$ ; for Loudspeakers:  $A_V = 6dB$ ,  $R_{L(SP)} = 15\mu H + 8\Omega + 15\mu H$ ,  $f = 1kHz$ , unless otherwise specified. Limits apply for  $T_A = 25^\circ C$ .

Symbol	Parameter	Conditions	LM49270		Units (Limits)
			Typical <sup>(2)</sup>	Limit <sup>(3) (4)</sup>	
$T_{ON}$	Turn-on Time		30		ms
$T_{OFF}$	Turn-off Time		64		ms
$Z_{IN}$	Input Impedance	Maximum Gain	23.5		k $\Omega$
		Minimum Gain	210		k $\Omega$
$A_V$	Gain	Maximum Gain, Speaker Mode	30		dB
		Minimum Gain, Speaker Mode	-47		dB
		Maximum Gain, Headphone Mode	18		dB
		Minimum Gain, Headphone Mode	-59		dB
PSRR	Power Supply Rejection Ratio	Speaker Mode, $V_{RIPPLE} = 200mVp-p$ Sine $f = 217Hz$ $f = 1kHz$	68 68		dB dB
		Headphone Mode, $V_{RIPPLE} = 200mVp-p$ Sine, CC Mode $f = 217Hz$ $f = 1kHz$	73 73		dB dB
		Headphone Mode, $V_{RIPPLE} = 200mVp-p$ Sine, OCL Mode $f = 217Hz$ $f = 1kHz$	75 79		dB dB
$HPS_{(Th)}$	Headphone Sense Threshold	Detect Headphone		2.9	V (min)
		Detect no Headphone		1.8	V (max)

### Electrical Characteristics $V_{DD} = 5.0V$

(1) The following specifications apply for Headphone"  $A_V = 0dB$ ,  $R_{L(HP)} = 32\Omega$ ; for Loudspeakers:  $A_V = 6dB$ ,  $R_{L(SP)} = 15\mu H + 8\Omega + 15\mu H$ ,  $f = 1kHz$  unless otherwise specified. Limits apply for  $T_A = 25^\circ C$ .

Symbol	Parameter	Conditions	LM49270		Units (Limits)
			Typical <sup>(2)</sup>	Limit <sup>(3) (4)</sup>	
$I_{DD}$	Supply Current	$V_{IN} = 0$ , $R_L =$ No Load, Both channels active	8.5	12.4	mA (max)
		Speaker ON, HP OFF	3.6	5.5	mA (max)
		Speaker OFF, CC HP ON	4.7	6.5	mA (max)
		Speaker OFF, OCL HP ON			
$I_{SD}$	Shutdown Supply Current		0.15	2	$\mu A$ (max)
$V_{OS}$	Output Offset Voltage	Headphone	10	25	mV (max)
		Speaker	10	60	mV (max)

(1) All voltages are measured with respect to the ground pin, unless otherwise specified.

(2) Typicals are measured at  $25^\circ C$  and represent the parametric norm.

(3) Limits are specified to AOQL (Average Outgoing Quality Level).

(4) Data sheet min and max specification limits are specified by design, test, or statistical analysis.

**Electrical Characteristics  $V_{DD} = 5.0V$  (continued)**

(1) The following specifications apply for Headphone"  $A_V = 0dB$ ,  $R_{L(HP)} = 32\Omega$ ,; for Loudspeakers:  $A_V = 6dB$ ,  $R_{L(SP)} = 15\mu H + 8\Omega + 15\mu H$ ,  $f = 1kHz$  unless otherwise specified. Limits apply for  $T_A = 25^\circ C$ .

Symbol	Parameter	Conditions	LM49270		Units (Limits)
			Typical (2)	Limit (3) (4)	
$P_{OUT}$	Output Power	Speaker Mode, $f = 1kHz$ ,			
		THD+N = 1%			W
		$R_L = 4\Omega$	1.75		W
		$R_L = 8\Omega$	1.06		
		THD+N = 10 %			W
		$R_L = 4\Omega$	2.2		W
		$R_L = 8\Omega$	1.35		
		CC Headphone Mode, $f = 1kHz$ ,			
		THD+N = 1%			mW
		$R_L = 16\Omega$	155		mW
$R_L = 32\Omega$	90				
THD+N = 10%			mW		
$R_L = 16\Omega$	177		mW		
$R_L = 32\Omega$	140				
OCL Headphone Mode, $f = 1kHz$ ,					
THD+N = 1%			mW		
$R_L = 16\Omega$	155		mW		
$R_L = 32\Omega$	90				
THD+N = 10%			mW		
$R_L = 16\Omega$	175		mW		
$R_L = 32\Omega$	140				
THD+N	Total Harmonic Distortion + Noise	Speaker Mode, $f = 1kHz$ $P_{OUT} = 100mW$ , $R_L = 8\Omega$	0.03		%
		CC Headphone Mode, $f = 1kHz$ $P_{OUT} = 12mW$ , $R_L = 32\Omega$	0.02		%
		OCL Headphone Mode, $f = 1kHz$ $P_{OUT} = 12mW$ , $R_L = 32\Omega$	0.03		%
$e_N$	Noise	Speaker Mode, A-Wtg, Input Referred	47		$\mu V$
		CC Headphone Mode, A-Wtg, Input Referred	10		$\mu V$
		OCL Headphone Mode, A-Wtg, Input Referred	11		$\mu V$
$\eta$	Efficiency	Speaker Mode $R_L = 8\Omega$	84		%
Xtalk	Crosstalk	Speaker Mode, $f = 1kHz$ , $V_{IN} = 1Vp-p$	-85		dB
		CC Headphone Mode, $f = 1kHz$ , $V_{IN} = 1Vp-p$	-70		dB
		OCL Headphone Mode, $f = 1kHz$ , $V_{IN} = 1Vp-p$	-58		dB
$T_{ON}$	Turn-on Time		43		ms
$T_{OFF}$	Turn-off Time		100		ms
$Z_{IN}$	Input Impedance	Maximum Gain	23.5		k $\Omega$
		Minimum Gain	210		k $\Omega$
$A_V$	Gain	Maximum Gain, Speaker Mode	30		dB
		Minimum Gain, Speaker Mode	-47		dB
		Maximum Gain, Headphone Mode	18		dB
		Minimum Gain, Headphone Mode	-59		dB

**Electrical Characteristics  $V_{DD} = 5.0V$  (continued)**

(1) The following specifications apply for Headphone"  $A_V = 0dB$ ,  $R_{L(HP)} = 32\Omega$ ,: for Loudspeakers:  $A_V = 6dB$ ,  $R_{L(SP)} = 15\mu H + 8\Omega + 15\mu H$ ,  $f = 1kHz$  unless otherwise specified. Limits apply for  $T_A = 25^\circ C$ .

Symbol	Parameter	Conditions	LM49270		Units (Limits)
			Typical (2)	Limit (3) (4)	
PSRR	Power Supply Rejection Ratio	Speaker Mode, $V_{RIPPLE} = 200mVp-p$ Sine $f = 217Hz$ $f = 1kHz$	61 61		dB dB
		Headphone Mode, $V_{RIPPLE} = 200mVp-p$ Sine, CC Mode $f = 217Hz$ $f = 1kHz$	75 74		dB min
		Headphone Mode, $V_{RIPPLE} = 200mVp-p$ Sine, OCL Mode $f = 217Hz$ $f = 1kHz$	78 75		dB dB
$HPS_{(Th)}$	Headphone Sense Threshold	Detect Headphone		4.4	V (min)
		Detect no Headphone		3	V (max)



### Typical Performance Characteristics

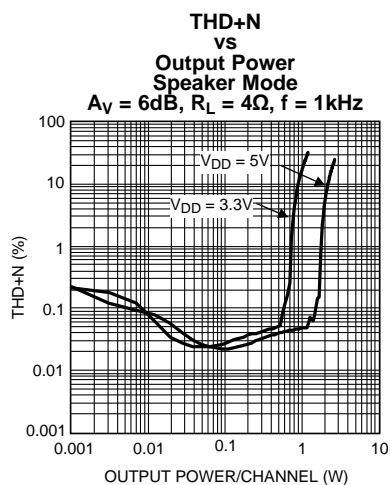

Figure 3.

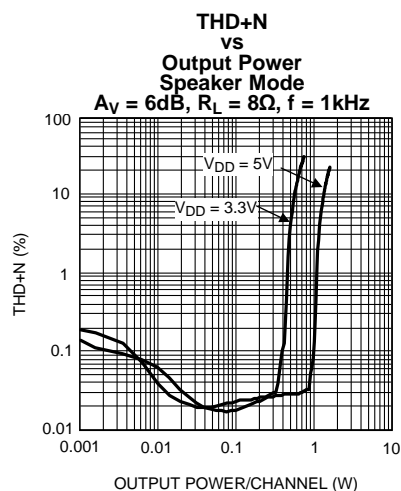

Figure 4.

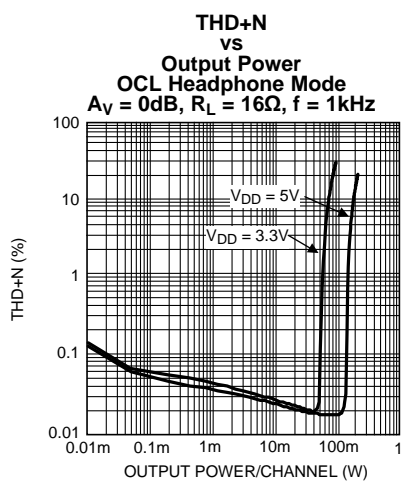

Figure 5.

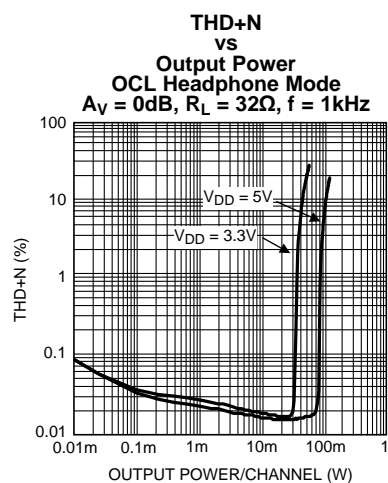

Figure 6.

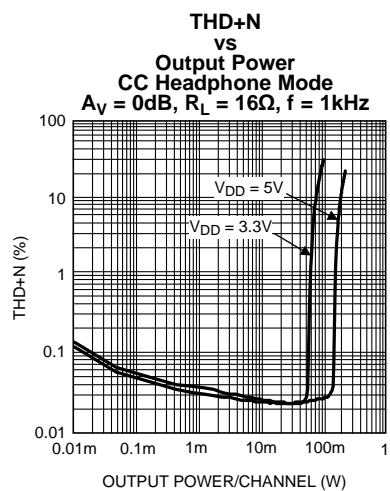

Figure 7.

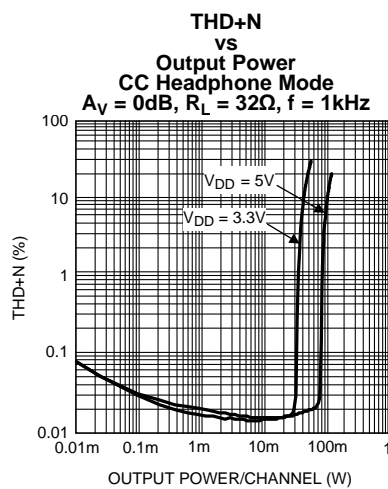
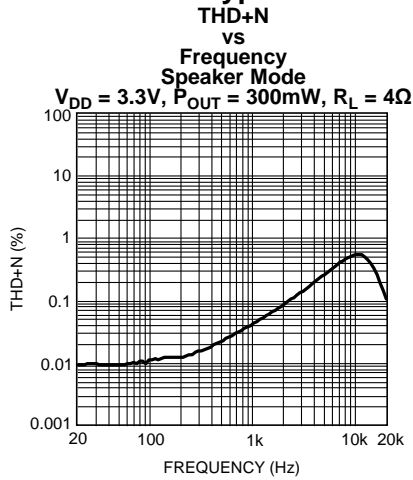
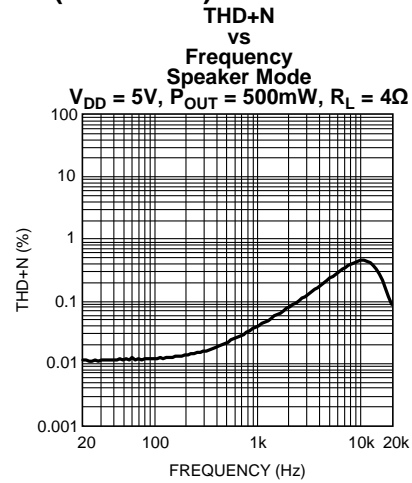

Figure 8.

**Typical Performance Characteristics (continued)**



**Figure 9.**



**Figure 10.**

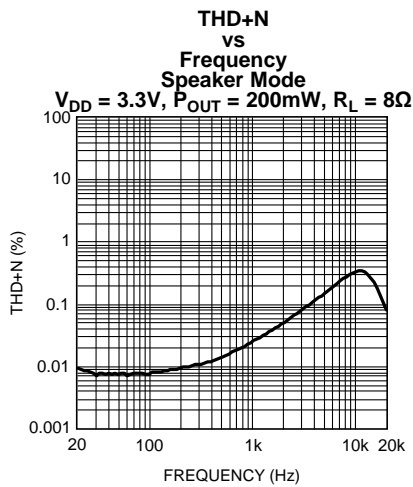

**Figure 11.**

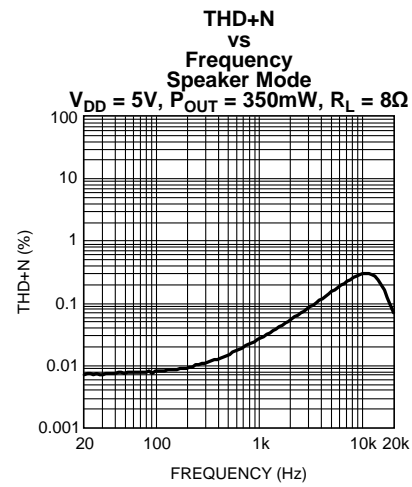

**Figure 12.**

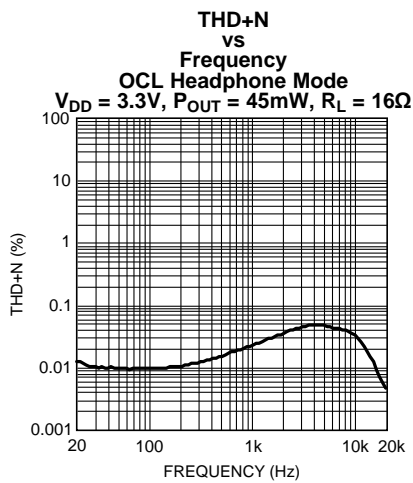

**Figure 13.**

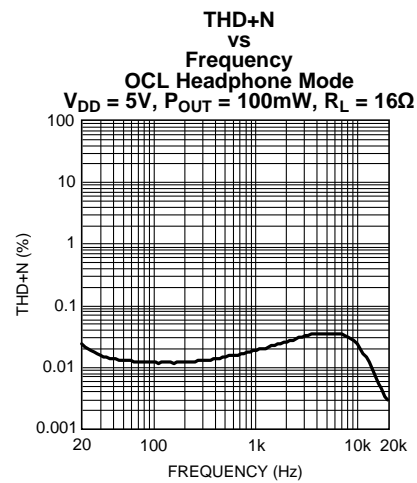

**Figure 14.**

**Typical Performance Characteristics (continued)**

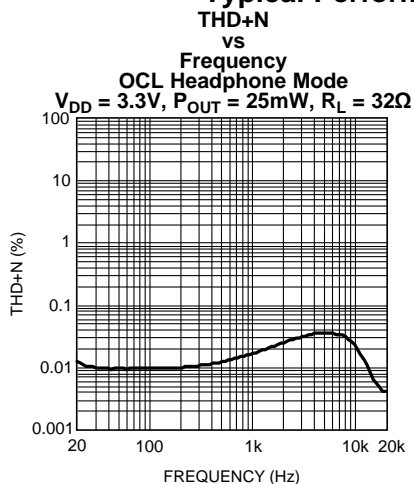

Figure 15.

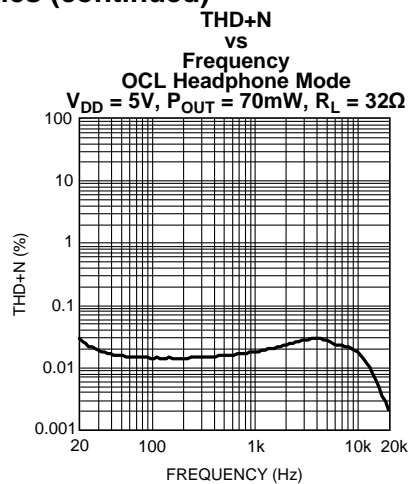

Figure 16.

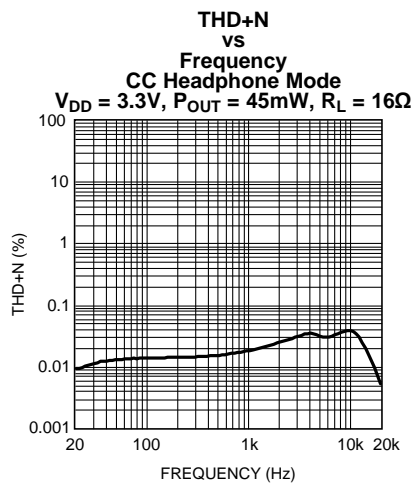

Figure 17.

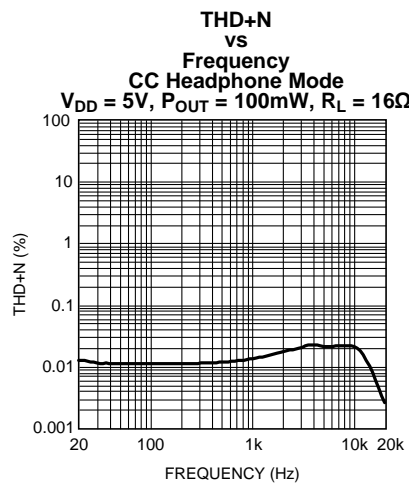

Figure 18.

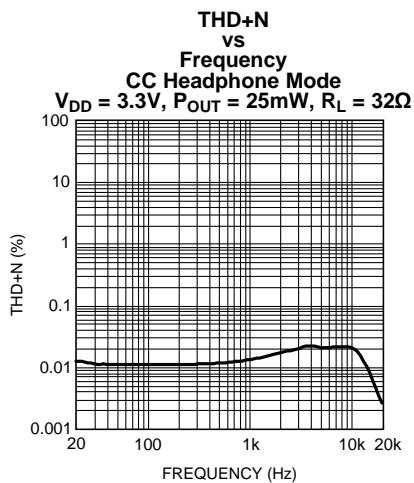

Figure 19.

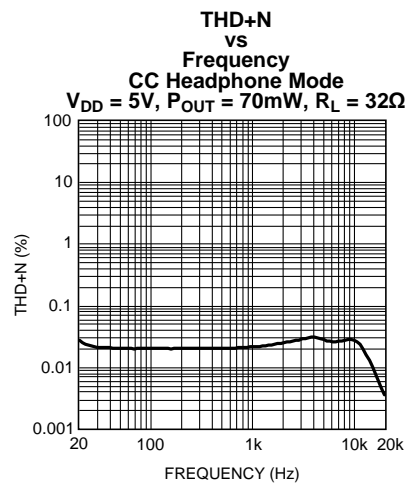

Figure 20.

**Typical Performance Characteristics (continued)**

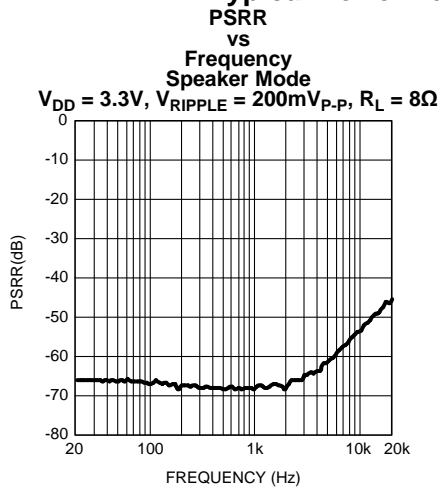

Figure 21.

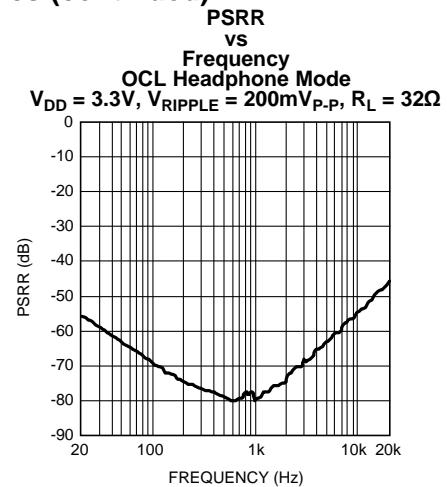

Figure 22.

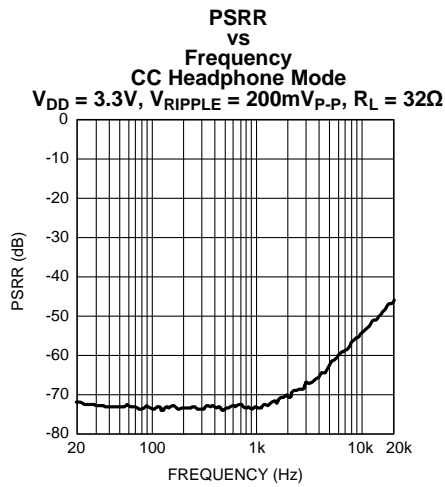

Figure 23.

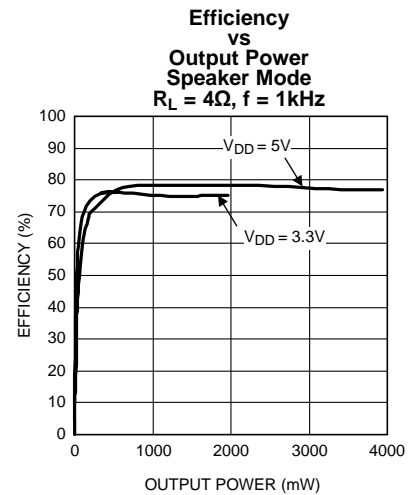

Figure 24.

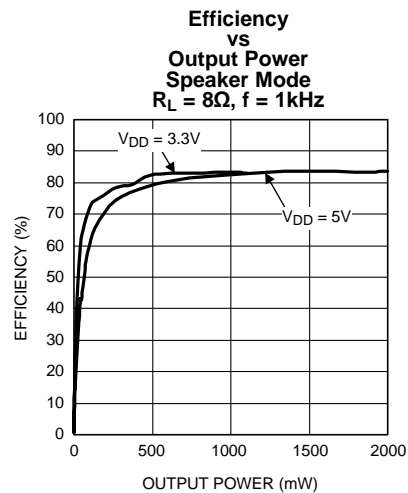

Figure 25.

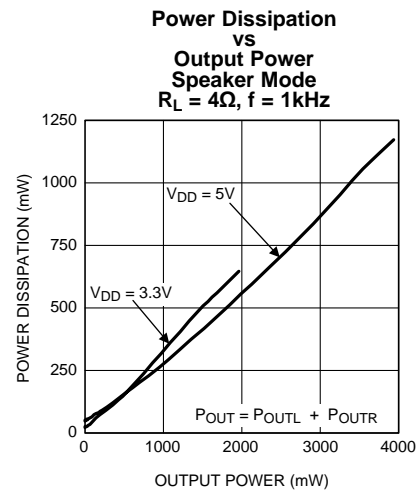

Figure 26.

Typical Performance Characteristics (continued)

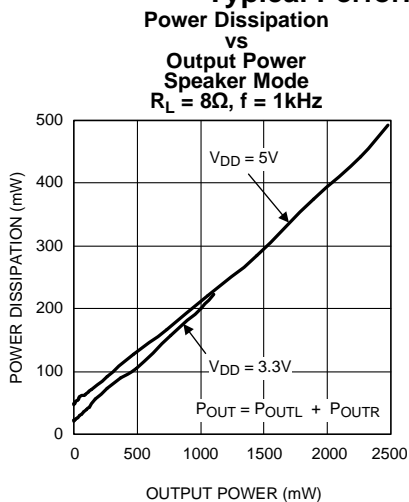

Figure 27.

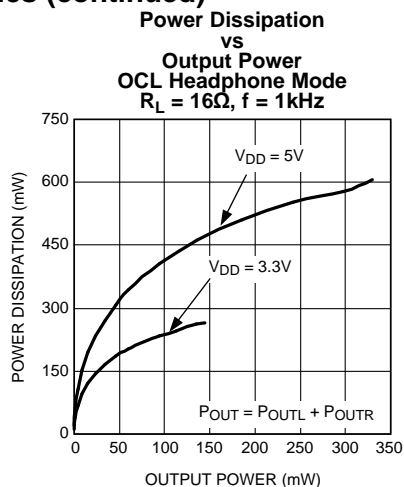

Figure 28.

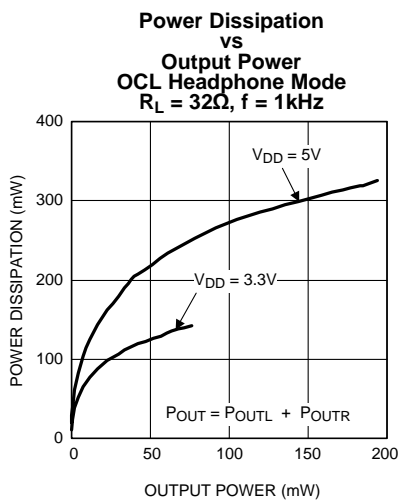

Figure 29.

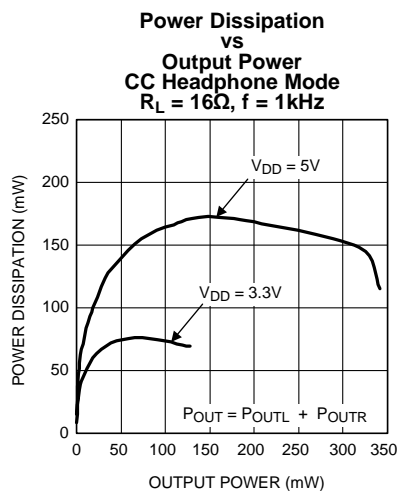

Figure 30.

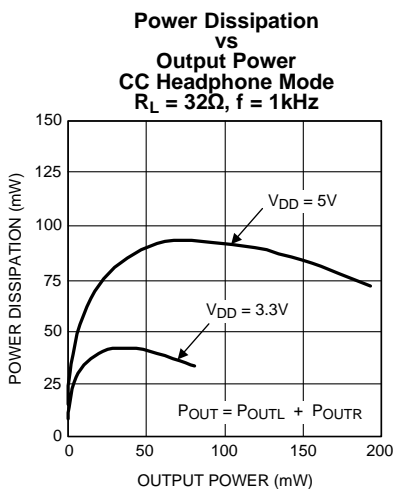

Figure 31.

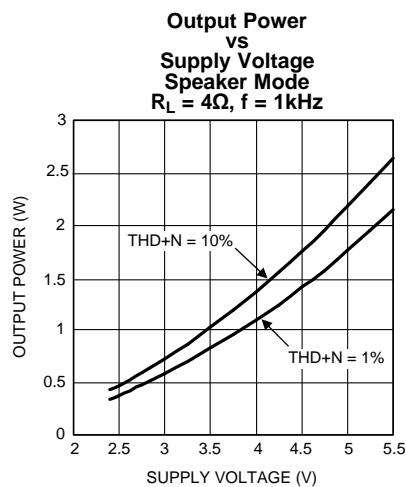

Figure 32.

**Typical Performance Characteristics (continued)**

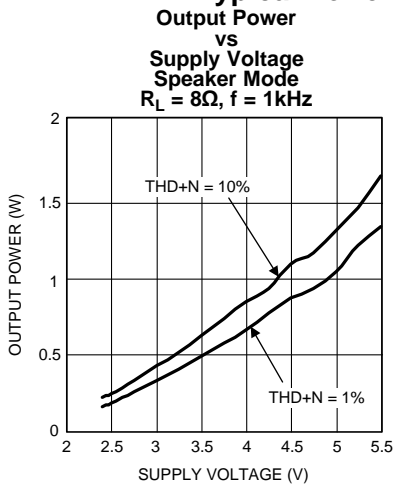

Figure 33.

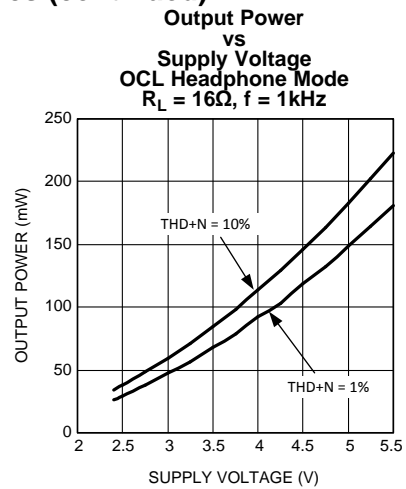

Figure 34.

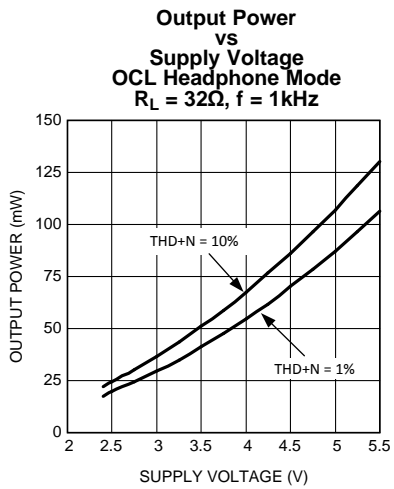

Figure 35.

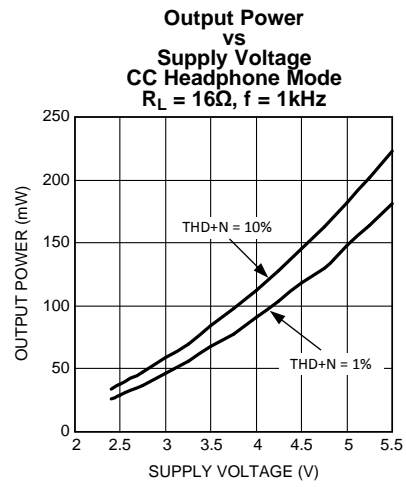

Figure 36.

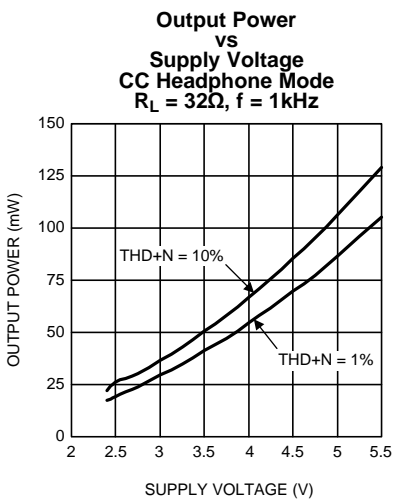

Figure 37.

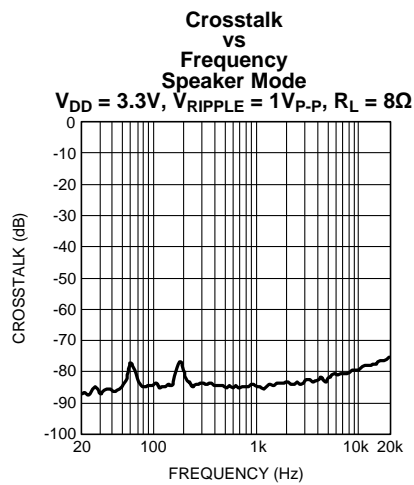

Figure 38.

Typical Performance Characteristics (continued)

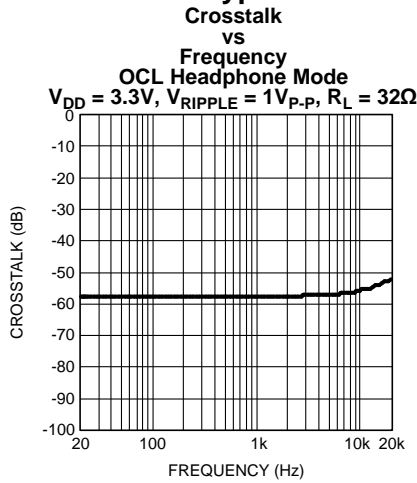

Figure 39.

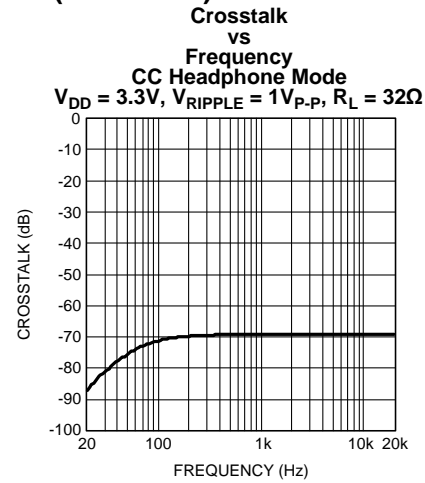

Figure 40.

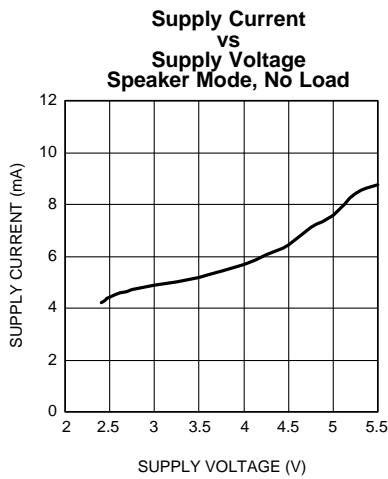

Figure 41.

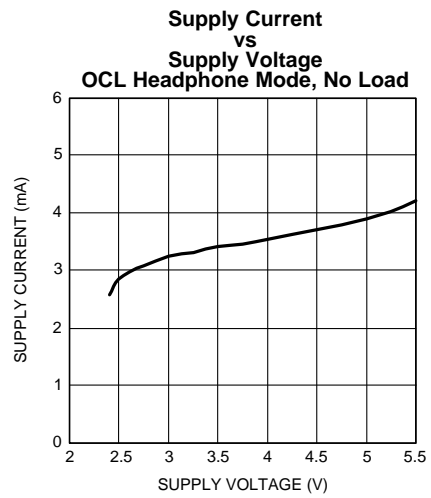

Figure 42.

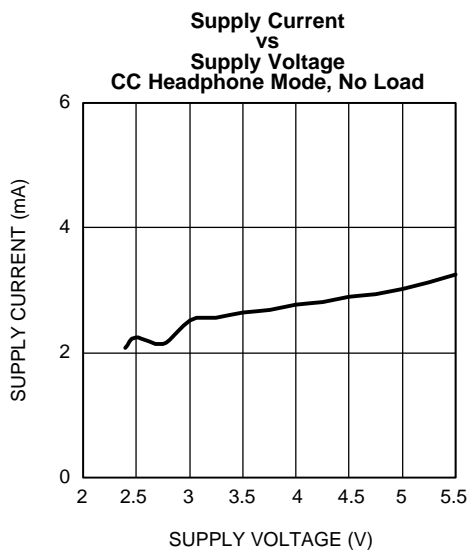

Figure 43.

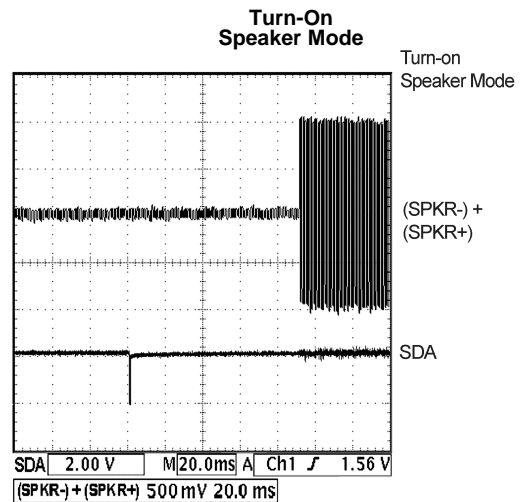

Figure 44.

**Typical Performance Characteristics (continued)**

**Turn-Off  
Speaker Mode**

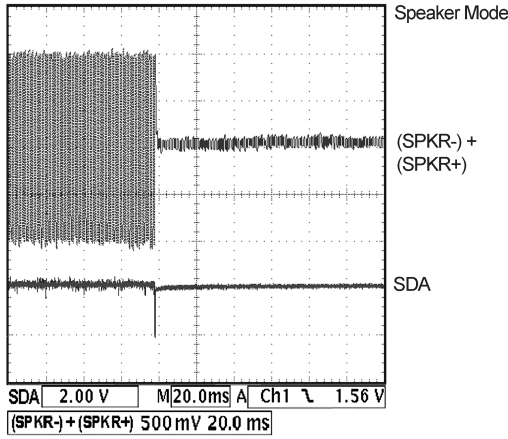

Figure 45.

**Turn-On  
OCL Headphone Mode**

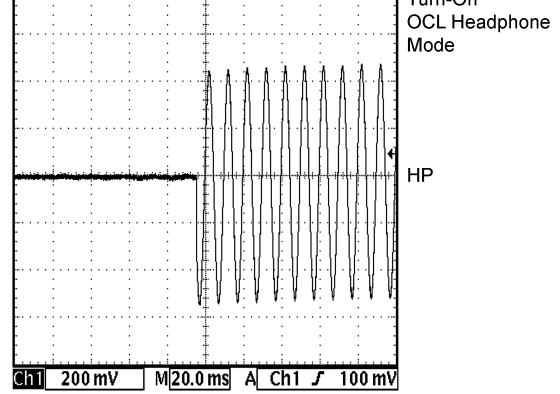

Figure 46.

**Turn-Off  
OCL Headphone Mode**

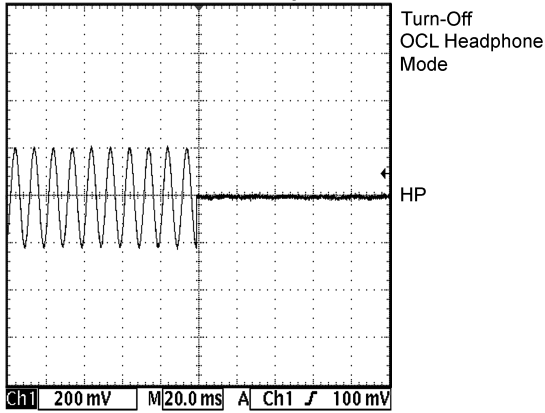

Figure 47.

**Turn-On  
CC Headphone Mode**

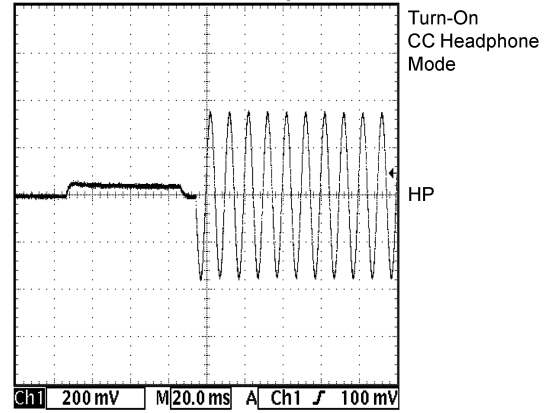

Figure 48.

**Turn-Off  
CC Headphone Mode**

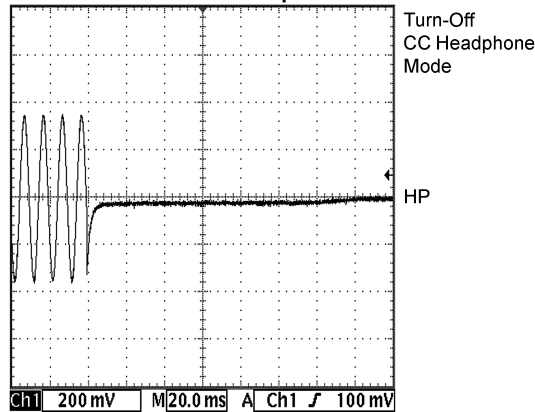

Figure 49.



## APPLICATION INFORMATION

### I<sup>2</sup>C COMPATIBLE INTERFACE

The LM49270 is controlled through an I<sup>2</sup>C compatible serial interface that consists of a serial data line (SDA) and a serial clock (SCL). The clock line is uni-directional. The data line is bi-directional (open-collector), although the LM49270 does not write to the I<sup>2</sup>C bus. The LM49270 and the master can communicate at clock rates up to 400kHz. [Figure 51](#) shows the I<sup>2</sup>C interface timing diagram. The LM49270 is a transmit/receive slave-only device, reliant upon the master to generate a clock signal.

The master device communicates to the LM49270 by transmitting the proper device address followed by a command word. Each transmission sequence is framed by a START condition and a STOP condition. Each word (register address + register content) transmitted over the bus is 8 bits long and is always followed by an acknowledge pulse.

To avoid an address conflict with another device on the I<sup>2</sup>C bus, the LM49270 address is determined by the ADR pin, the state of ADR determines address bit A1 ([Table 1](#)). When ADR = 0, the address is 1111 1000. When ADR = 1 the device address is 1111 1010.

**Table 1. Device Address**

ADR	A7	A6	A5	A4	A3	A2	A1	A0
X	1	1	1	1	1	0	X	0
0	1	1	1	1	1	0	0	0
1	1	1	1	1	1	0	1	0

**Table 2. I<sup>2</sup>C Control Registers**

REG	Register Name	D7	D6	D5	D4	D3	D2	D1	D0
0	Shutdown Control	0	0	—	—	HP3DSEL	LS3DSEL	OCL/CC	PWR_ON
1	Headphone Gain Control	0	1	—	HP4	HP3	HP2	HP1	HP0
2	Speaker Gain Control	1	0	—	LS4	LS3	LS2	LS1	LS0

#### NOTE

OCL/CC = 1 selects OCL mode; OCL/CC = 0 selects cap coupled mode

PWR\_ON = 0 puts part in shutdown

### BUS FORMAT

The I<sup>2</sup>C bus format is shown in [Figure 50](#). The “start” signal is generated by lowering the data signal while the clock is high. The start signal alerts all devices on the bus that a device address is being written to the bus.

The 8-bit device address is written to the bus next, most significant bit first. The data is latched in on the rising edge of the clock. Each address bit must be stable while the clock is high.

After the last address bit is sent, the master device releases the data line, during which time, an acknowledge clock pulse is generated. If the LM49270 receives the address correctly, then the LM49270 pulls the data line low, generating an acknowledge bit (ACK).

Once the master device has registered the ACK bit, the 8-bit register address/data word is sent. Each data bit should be stable while the clock level is high. After the 8-bit word is sent, the LM49270 sends another ACK bit. Following the acknowledgement of the data word, the master device issues a “stop” bit, allowing SDA to go high while the clock signal is high.

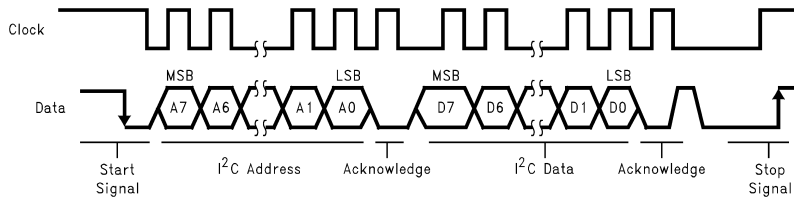
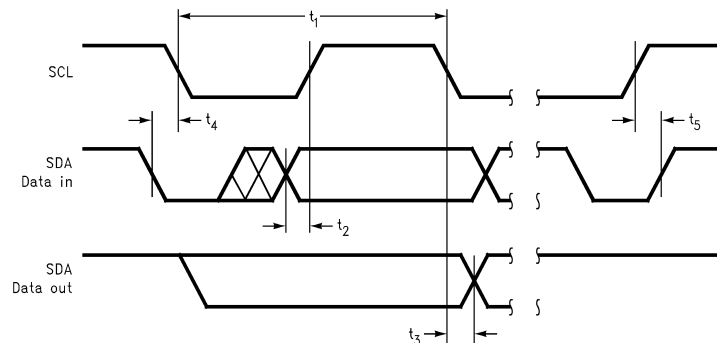
Figure 50. I<sup>2</sup>C Bus FormatFigure 51. I<sup>2</sup>C Timing Diagram

## GENERAL AMPLIFIER FUNCTION

### Class D Amplifier

The LM49270 features a high-efficiency, filterless, Class D stereo amplifier. The LM49270 Class D amplifiers feature a filterless modulation scheme known as Class BD. The differential outputs of each channel switch at 300kHz from  $V_{DD}$  to GND. When there is no input signal applied, the two outputs (LLS+ and LLS-) switch in phase with a 50% duty cycle. Because the outputs of the LM49270 are differential, there is in no net voltage across the speaker, thus no load current during the idle state conserving power.

When an input signal is applied, the duty cycle (pulse width) of each output changes. For increasing output voltages, the duty cycle of LLS+ increases, while the duty cycle of LLS- decreases. For decreasing output voltages, the converse occurs. The duty cycle of LLS- increases while the duty cycle of LLS+ decreases. The difference between the two pulse widths yields the differential output voltage.

### Headphone Amplifier

The LM49270 headphone amplifier features two different operating modes, output capacitor-less (OCL) and capacitor coupled (CC). The OCL architecture eliminates the bulky, expensive output coupling capacitors required by traditional headphone amplifiers. The LM49270 headphone section uses three amplifiers. Two amplifiers drive the headphones while the third (VOC) is set to the internally generated bias voltage (typically  $V_{DD}/2$ ). The third amplifier is connected to the return terminal (sleeve) of the headphone jack. In this configuration, the signal side of the headphones are biased to  $V_{DD}/2$ , the return is biased to  $V_{DD}/2$ , thus there is no net DC voltage across the headphone eliminating the need for an output coupling capacitor. Removing the output coupling capacitors from the headphone signal path reduces component count, reducing system cost and board space consumption, as well as improving low frequency performance and sound quality. The voltage on the return sleeve is not an issue when driving headphones. However, if the headphone output is used as a line out, the  $V_{DD}/2$  can conflict with the GND potential that a line-in would expect on the return sleeve. When the return of the headphone jack is connected to GND, the LM49270 detects an output short circuit condition and the VOC amplifier is disabled preventing damage to the LM49270 and allowing the headphone return to be biased at GND.

### Capacitor Coupled Headphone Mode

In capacitor coupled (CC) mode, the VOC pin is disabled, and the headphone outputs are coupled to the jack through series capacitors, allowing the headphone return to be connected to GND (Figure 52). In CC mode, the LM49270 requires output coupling capacitors to block the DC component of the amplifier output, preventing DC current from flowing to the load. The output capacitor and speaker impedance form a high pass filter with a -3dB roll-off determined by:

$$f_{-3dB} = 1 / 2\pi R_L C_{OUT}$$

Where  $R_L$  is the headphone impedance, and  $C_{OUT}$  is the output coupling capacitor. Choose  $C_{OUT}$  such that  $f_{-3dB}$  is well below the lowest frequency of interest. Setting  $f_{-3dB}$  too high results in poor low frequency performance. Select capacitor dielectric types with low ESR to minimize signal loss due to capacitor series resistance and maximize power transfer to the load.

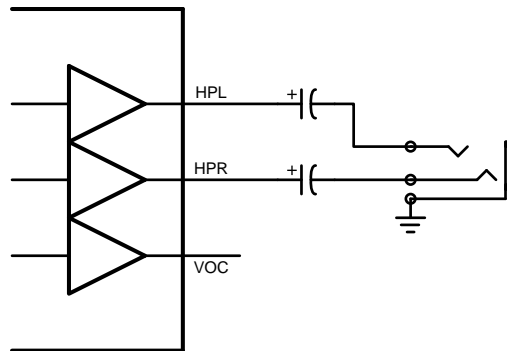

Figure 52. Capacitor Coupled Headphone Mode

### Headphone Sense

The LM49270 features a headphone sense input (HPS) that monitors the headphone jack and configures the device depending on the presence of a headphone. When the HPS pin is low, indicating that a headphone is not present, the LM49270 speaker amplifiers are active and the headphone amplifiers are disabled. When the HPS pin is high, indicating that a headphone is present, the headphone amplifiers are active while the speaker amplifiers are disabled.

### POWER DISSIPATION AND EFFICIENCY

The major benefit of Class D amplifier is increased efficiency versus Class AB. The efficiency of the LM49270 speaker amplifiers is attributed to the output transistors' region of operation. The Class D output stage acts as current steering switches, consuming negligible amounts of power compared to their Class AB counterparts. Most of the power loss associated with the output stage is due to the IR loss of the MOSFET on-resistance ( $R_{DS(ON)}$ ), along with the switching losses due to gate charge.

The maximum power dissipation per headphone channel in Capacitor Coupled mode is given by:

$$P_{DMAX(CC)} = V_{DD}^2 / 2\pi^2 R_L$$

In OCL mode, the maximum power dissipation increases due to the use of a third amplifier as a buffer. The power dissipation is given by:

$$P_{DMAX(OCL)} = V_{DD}^2 / \pi^2 R_L$$

### SHUTDOWN FUNCTION

The LM49270 features a shutdown mode configured through the I<sup>2</sup>C interface. Bit D0 (PWR\_ON) in the Shutdown Control register shuts down/turns on the entire device. Set PWR\_ON = 1 to enable the LM49270, set PWR\_ON = 0 to disable the device.

### AUDIO AMPLIFIER GAIN SETTING

Each channel of the LM49270 features a 32 step volume control. The loudspeaker volume has a range of -47dB to 30dB and the headphone has a range of -59dB to 18dB (see Table 3).

**Table 3. Volume Control**

Volume Step	LS4/HP4	LS3/HP3	LS2/HP2	LS1/HP1	LS0/HP0	LS Gain (dB)	HP Gain (dB)
1	0	0	0	0	0	-47	-59
2	0	0	0	0	1	-36	-48
3	0	0	0	1	0	-28.5	-46.5
4	0	0	0	1	1	-22.5	-34.5
5	0	0	1	0	0	-18	-30
6	0	0	1	0	1	-15	-27
7	0	0	1	1	0	-12	-24
8	0	0	1	1	1	-9	-21
9	0	1	0	0	0	-6	-18
10	0	1	0	0	1	-3	-15
11	0	1	0	1	0	-1.5	-13.5
12	0	1	0	1	1	0	-12
13	0	1	1	0	0	1.5	-10.5
14	0	1	1	0	1	3	-9
15	0	1	1	1	0	4.5	-7.5
16	0	1	1	1	1	6	-6
17	1	0	0	0	0	7.5	-4.5
18	1	0	0	0	1	9	-3
19	1	0	0	1	0	10.5	-1.5
20	1	0	0	1	1	12	0
21	1	0	1	0	0	13.5	1.5
22	1	0	1	0	1	15	3
23	1	0	1	1	0	16.5	4.5
24	1	0	1	1	1	18	6
25	1	1	0	0	0	19.5	7.5
26	1	1	0	0	1	21	9
27	1	1	0	1	0	22.5	10.5
28	1	1	0	1	1	24	12
29	1	1	1	0	0	25.5	13.5
30	1	1	1	0	1	27	15
31	1	1	1	1	0	28.5	16.5
32	1	1	1	1	1	30	18

### 3D ENHANCEMENT

The LM49270 features TI's 3D sound enhancement. 3D sound improves the apparent stereo channel separation whenever the left and right speakers are located close to each other, widening the perceived sound stage in devices with a small form factor that prohibits proper speaker placement.

An external RC network, shown in [Figure 1](#), enables the 3D effect. R3D sets the level of the 3D effect; decreasing the value of R3D will increase the 3D effect. The 3D network acts like a high pass filter C3D sets the frequency response; increasing the value of C3D will decrease the low cutoff frequency at which the 3D effect starts to occur, as shown by this equation:

$$f_{3D(-3dB)} = 1/2\pi(R3D)(C3D) \quad (1)$$

Enabling the 3D effect increases the gain by a multiplication factor of  $(1 + 20k\Omega/R3D)$ . Setting R3D to 20k $\Omega$  results in a 6dB increase (doubling) of the gain, increasing the 3D effect. The level of 3D effect is also dependent on other factors such as speaker placement and the distance from the speakers to the listener. The values of R3D and C3D should be chosen for each application individually, taking into account the physical factors noted before.

## POWER SUPPLIES

The LM49270 uses different supplies for each portion of the device, allowing for the optimum combination of headroom, power dissipation and noise immunity. The speaker amplifier gain stage is powered from  $V_{DD}$ , while the output stage is powered from  $LSV_{DD}$ . The headphone amplifiers, input amplifiers and volume control stages are powered from  $HPV_{DD}$ . The separate power supplies allow the speakers to operate from a higher voltage for maximum headroom, while the headphones operate from a lower voltage, improving power dissipation.  $HPV_{DD}$  may be driven by a linear regulator to further improve performance in noisy environments. The I<sup>2</sup>C portion is powered from  $I^2CV_{DD}$ , allowing the I<sup>2</sup>C portion of the LM49270 to interface with lower voltage digital controllers.

## PROPER SELECTION OF EXTERNAL COMPONENTS

### Audio Amplifier Power Supply Bypassing/Filtering

Proper power supply bypassing is critical for low noise performance and high PSRR. Place the supply bypass capacitor as close to the device as possible. Typical applications employ a voltage regulator with 10 $\mu$ F and 0.1 $\mu$ F bypass capacitors that increase supply stability. These capacitors do not eliminate the need for bypassing of the LM49270 supply pins. A 1 $\mu$ F capacitor is recommended.

### Bypass Capacitor Selection

The LM49270 generates a  $V_{DD}/2$  common-mode bias voltage internally. The BYPASS capacitor,  $C_B$ , improves PSRR and THD+N by reducing noise at the BYPASS node. Use a 1 $\mu$ F capacitor, placed as close to the device as possible for  $C_B$ .

### Audio Amplifier Input Capacitor Selection

Input capacitors,  $C_{IN}$ , in conjunction with the input impedance of the LM49270 forms a high pass filter that removes the DC bias from an incoming signal. The AC-coupling capacitor allows the amplifier to bias the signal to an optimal DC level. Assuming zero source impedance, the -3dB point of the high pass filter is given by:

$$f_{(-3dB)} = 1/2\pi R_{IN} C_{IN} \quad (2)$$

Choose  $C_{IN}$  such that  $f_{-3dB}$  is well below that lowest frequency of interest. Setting  $f_{-3dB}$  too high affects the low-frequency responses of the amplifier. Use capacitors with low voltage coefficient dielectrics, such as tantalum or aluminum electrolytic. Capacitors with high-voltage coefficients, such as ceramics, may result in increased distortion at low frequencies. Other factors to consider when designing the input filter include the constraints of the overall system. Although high fidelity audio requires a flat frequency response between 20Hz and 20kHz, portable devices such as cell phones may only concentrate on the frequency range of the frequency range of the spoken human voice (typically 300Hz to 4kHz). In addition, the physical size of the speakers used in such portable devices limits the low frequency response; in this case, frequencies below 150Hz may be filtered out.

**REVISION TABLE**

<b>Rev</b>	<b>Date</b>	<b>Description</b>
1.0	12/19/06	Initial release.

**PACKAGING INFORMATION**

Orderable Device	Status (1)	Package Type	Package Drawing	Pins	Package Qty	Eco Plan (2)	Lead finish/ Ball material (6)	MSL Peak Temp (3)	Op Temp (°C)	Device Marking (4/5)	Samples
LM49270SQ/NOPB	ACTIVE	WQFN	RSG	28	1000	RoHS & Green	SN	Level-1-260C-UNLIM	-40 to 85	49270SQ	Samples

(1) The marketing status values are defined as follows:

**ACTIVE:** Product device recommended for new designs.

**LIFEBUY:** TI has announced that the device will be discontinued, and a lifetime-buy period is in effect.

**NRND:** Not recommended for new designs. Device is in production to support existing customers, but TI does not recommend using this part in a new design.

**PREVIEW:** Device has been announced but is not in production. Samples may or may not be available.

**OBSOLETE:** TI has discontinued the production of the device.

(2) **RoHS:** TI defines "RoHS" to mean semiconductor products that are compliant with the current EU RoHS requirements for all 10 RoHS substances, including the requirement that RoHS substance do not exceed 0.1% by weight in homogeneous materials. Where designed to be soldered at high temperatures, "RoHS" products are suitable for use in specified lead-free processes. TI may reference these types of products as "Pb-Free".

**RoHS Exempt:** TI defines "RoHS Exempt" to mean products that contain lead but are compliant with EU RoHS pursuant to a specific EU RoHS exemption.

**Green:** TI defines "Green" to mean the content of Chlorine (Cl) and Bromine (Br) based flame retardants meet JS709B low halogen requirements of <=1000ppm threshold. Antimony trioxide based flame retardants must also meet the <=1000ppm threshold requirement.

(3) MSL, Peak Temp. - The Moisture Sensitivity Level rating according to the JEDEC industry standard classifications, and peak solder temperature.

(4) There may be additional marking, which relates to the logo, the lot trace code information, or the environmental category on the device.

(5) Multiple Device Markings will be inside parentheses. Only one Device Marking contained in parentheses and separated by a "-" will appear on a device. If a line is indented then it is a continuation of the previous line and the two combined represent the entire Device Marking for that device.

(6) Lead finish/Ball material - Orderable Devices may have multiple material finish options. Finish options are separated by a vertical ruled line. Lead finish/Ball material values may wrap to two lines if the finish value exceeds the maximum column width.

**Important Information and Disclaimer:** The information provided on this page represents TI's knowledge and belief as of the date that it is provided. TI bases its knowledge and belief on information provided by third parties, and makes no representation or warranty as to the accuracy of such information. Efforts are underway to better integrate information from third parties. TI has taken and continues to take reasonable steps to provide representative and accurate information but may not have conducted destructive testing or chemical analysis on incoming materials and chemicals. TI and TI suppliers consider certain information to be proprietary, and thus CAS numbers and other limited information may not be available for release.

In no event shall TI's liability arising out of such information exceed the total purchase price of the TI part(s) at issue in this document sold by TI to Customer on an annual basis.

**TAPE AND REEL INFORMATION**

**QUADRANT ASSIGNMENTS FOR PIN 1 ORIENTATION IN TAPE**

\*All dimensions are nominal

Device	Package Type	Package Drawing	Pins	SPQ	Reel Diameter (mm)	Reel Width W1 (mm)	A0 (mm)	B0 (mm)	K0 (mm)	P1 (mm)	W (mm)	Pin1 Quadrant
LM49270SQ/NOPB	WQFN	RSG	28	1000	178.0	12.4	5.3	5.3	1.3	8.0	12.0	Q1



**TAPE AND REEL BOX DIMENSIONS**

\*All dimensions are nominal

Device	Package Type	Package Drawing	Pins	SPQ	Length (mm)	Width (mm)	Height (mm)
LM49270SQ/NOPB	WQFN	RSG	28	1000	208.0	191.0	35.0

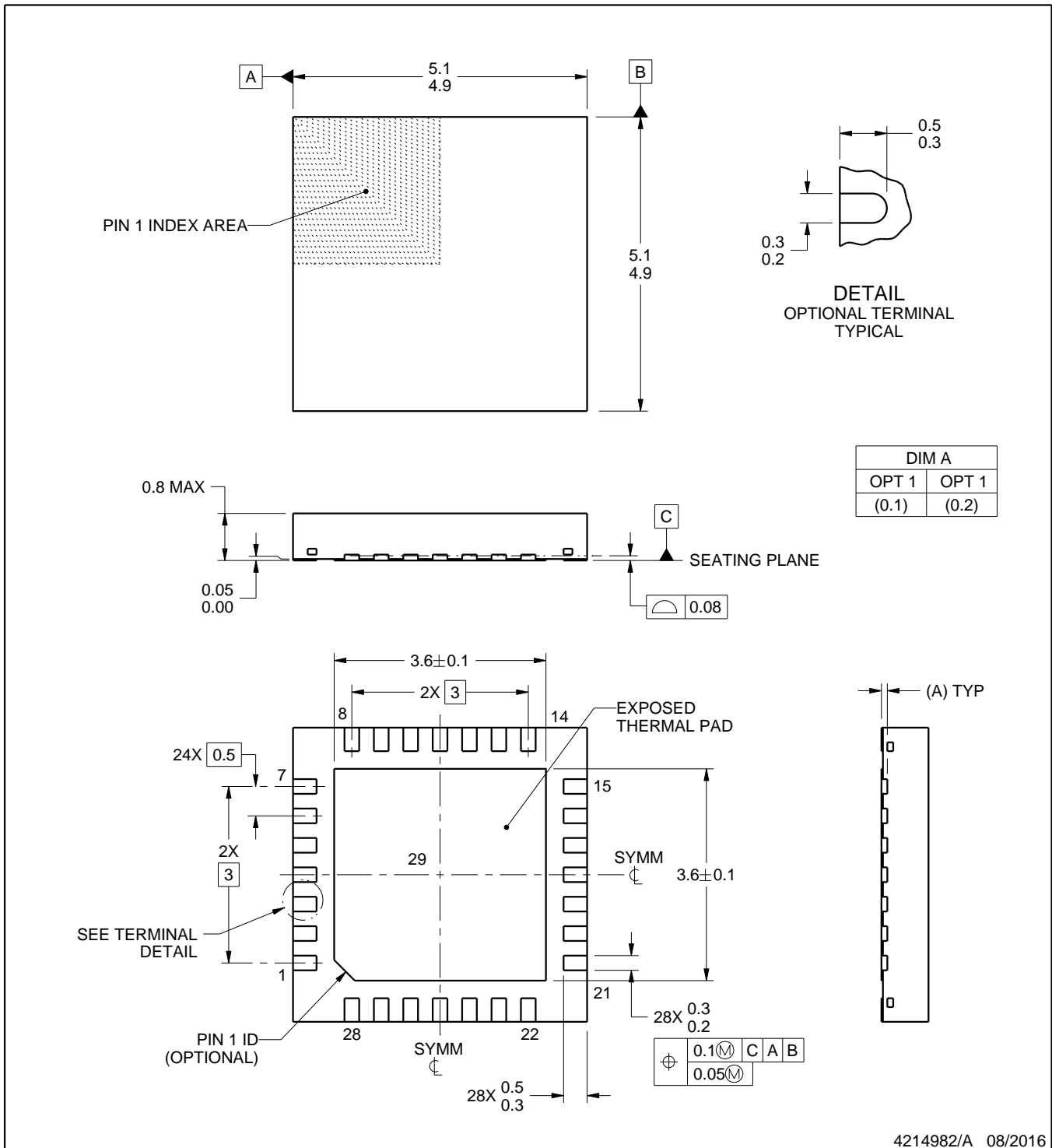
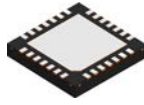

4214982/A 08/2016

NOTES:

1. All linear dimensions are in millimeters. Any dimensions in parenthesis are for reference only. Dimensioning and tolerancing per ASME Y14.5M.
2. This drawing is subject to change without notice.
3. The package thermal pad must be soldered to the printed circuit board for thermal and mechanical performance.

# EXAMPLE BOARD LAYOUT

RSG0028A

WQFN - 0.8 mm max height

PLASTIC QUAD FLATPACK - NO LEAD

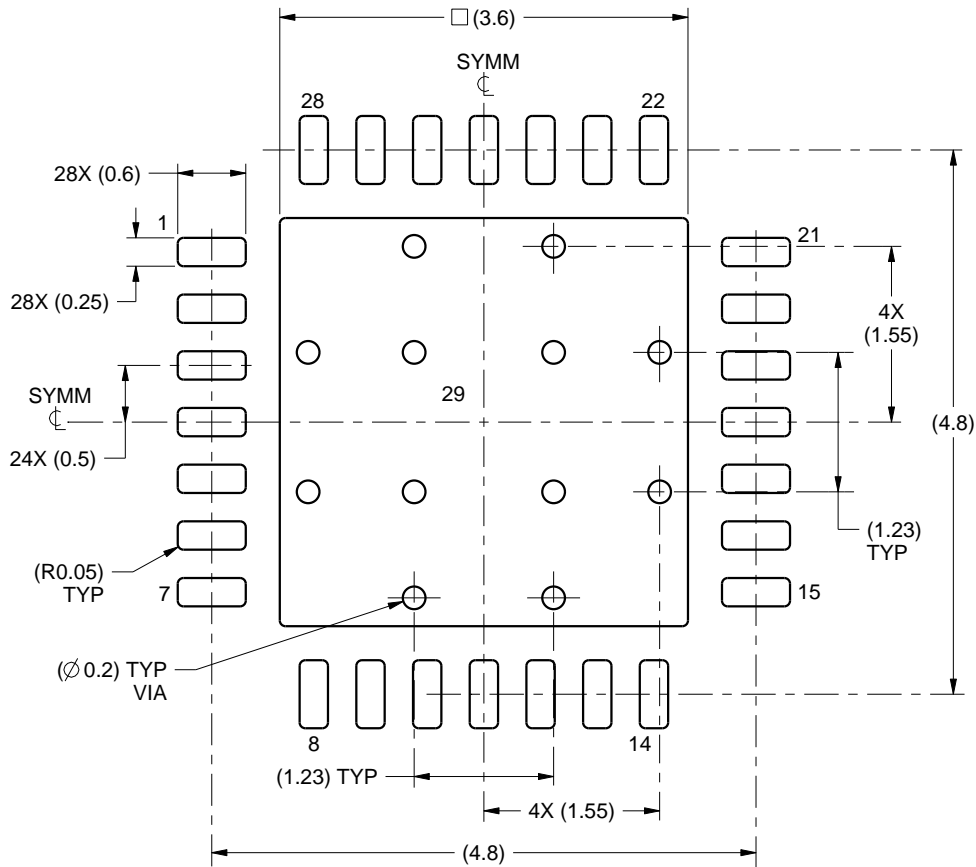

LAND PATTERN EXAMPLE  
SCALE:15X

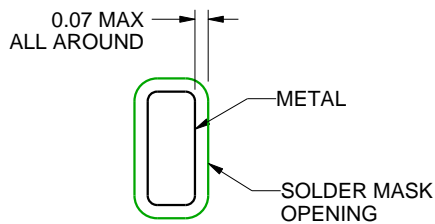

NON SOLDER MASK  
DEFINED  
(PREFERRED)

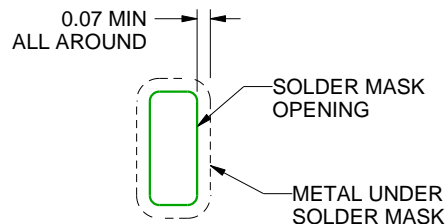

SOLDER MASK  
DEFINED

## SOLDER MASK DETAILS

4214982/A 08/2016

NOTES: (continued)

- This package is designed to be soldered to a thermal pad on the board. For more information, see Texas Instruments literature number SLUA271 ([www.ti.com/lit/sluea271](http://www.ti.com/lit/sluea271)).
- Vias are optional depending on application, refer to device data sheet. If any vias are implemented, refer to their locations shown on this view. It is recommended that vias under paste be filled, plugged or tented.

# EXAMPLE STENCIL DESIGN

RSG0028A

WQFN - 0.8 mm max height

PLASTIC QUAD FLATPACK - NO LEAD

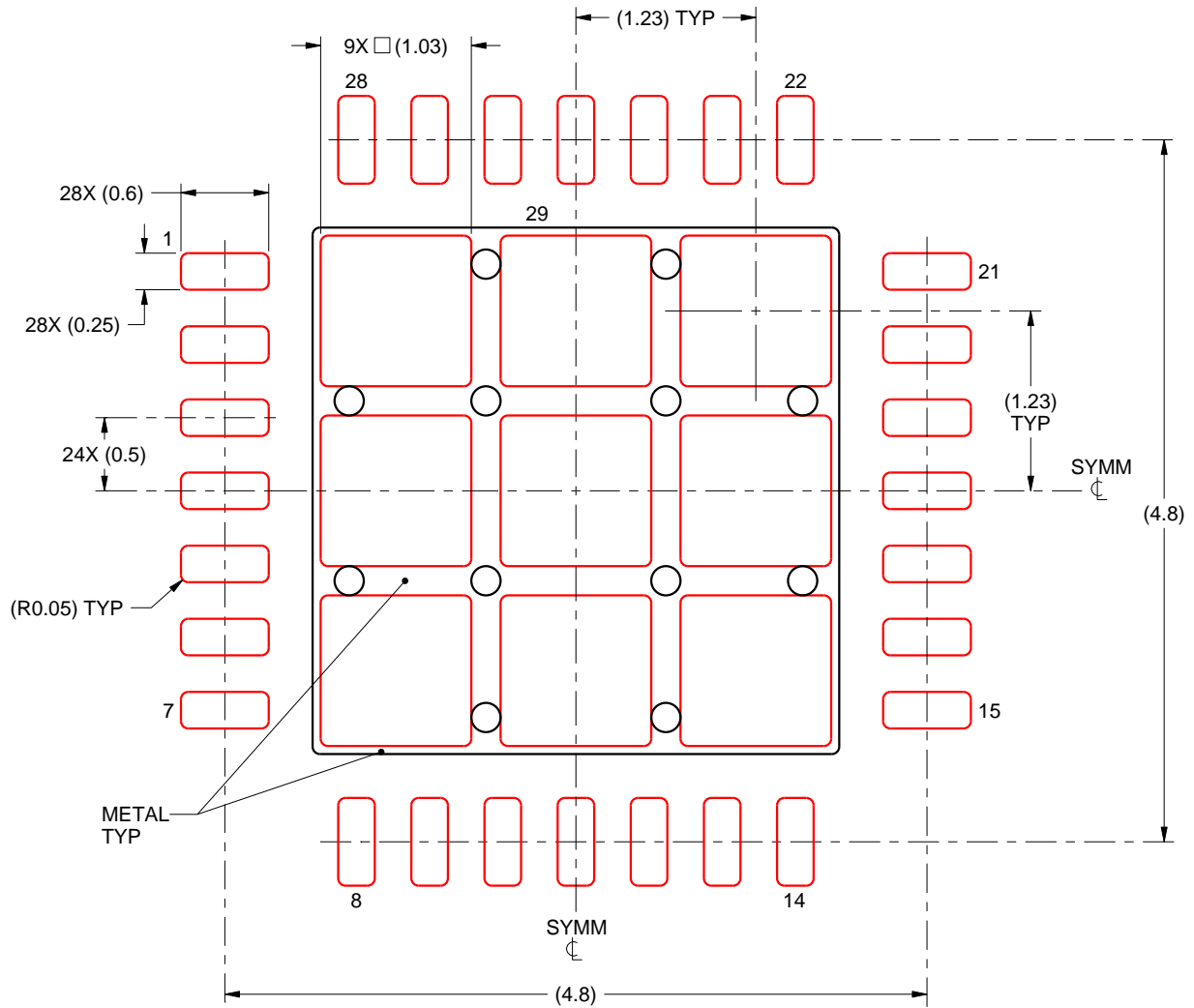

SOLDER PASTE EXAMPLE  
BASED ON 0.125 mm THICK STENCIL

EXPOSED PAD 29  
73.7% PRINTED SOLDER COVERAGE BY AREA UNDER PACKAGE  
SCALE:20X

4214982/A 08/2016

NOTES: (continued)

6. Laser cutting apertures with trapezoidal walls and rounded corners may offer better paste release. IPC-7525 may have alternate design recommendations.

## IMPORTANT NOTICE AND DISCLAIMER

TI PROVIDES TECHNICAL AND RELIABILITY DATA (INCLUDING DATA SHEETS), DESIGN RESOURCES (INCLUDING REFERENCE DESIGNS), APPLICATION OR OTHER DESIGN ADVICE, WEB TOOLS, SAFETY INFORMATION, AND OTHER RESOURCES "AS IS" AND WITH ALL FAULTS, AND DISCLAIMS ALL WARRANTIES, EXPRESS AND IMPLIED, INCLUDING WITHOUT LIMITATION ANY IMPLIED WARRANTIES OF MERCHANTABILITY, FITNESS FOR A PARTICULAR PURPOSE OR NON-INFRINGEMENT OF THIRD PARTY INTELLECTUAL PROPERTY RIGHTS.

These resources are intended for skilled developers designing with TI products. You are solely responsible for (1) selecting the appropriate TI products for your application, (2) designing, validating and testing your application, and (3) ensuring your application meets applicable standards, and any other safety, security, regulatory or other requirements.

These resources are subject to change without notice. TI grants you permission to use these resources only for development of an application that uses the TI products described in the resource. Other reproduction and display of these resources is prohibited. No license is granted to any other TI intellectual property right or to any third party intellectual property right. TI disclaims responsibility for, and you will fully indemnify TI and its representatives against, any claims, damages, costs, losses, and liabilities arising out of your use of these resources.

TI's products are provided subject to [TI's Terms of Sale](#) or other applicable terms available either on [ti.com](http://ti.com) or provided in conjunction with such TI products. TI's provision of these resources does not expand or otherwise alter TI's applicable warranties or warranty disclaimers for TI products.

TI objects to and rejects any additional or different terms you may have proposed.

Mailing Address: Texas Instruments, Post Office Box 655303, Dallas, Texas 75265  
Copyright © 2021, Texas Instruments Incorporated