



± 2g / 4g / 8g Tri-axis Digital Accelerometer Specifications

PART NUMBER:

KX127-1068

Rev. 2.0

05-Jun-2019

Product Description

The KX127-1068 is a tri-axis $\pm 2g$, $\pm 4g$, or $\pm 8g$ silicon micromachined accelerometer with integrated Pedometer, 2048-byte buffer, orientation, Directional-Tap™/Double-Tap™, activity detecting, and Free fall algorithms. The sense element is fabricated using Kionix's proprietary plasma micromachining process technology. Acceleration sensing is based on the principle of a differential capacitance arising from acceleration-induced motion of the sense element, which further utilizes common mode cancellation to decrease errors from process variation, temperature, and environmental stress. The sense element is hermetically sealed at the wafer level by bonding a second silicon lid wafer to the device using a glass frit. A separate ASIC device packaged with the sense element provides signal conditioning, and intelligent user-programmable application algorithms. The accelerometer is delivered in a 2 x 2 x 0.9 mm LGA plastic package operating from a 1.71V – 3.6V DC supply. Voltage regulators are used to maintain constant internal operating voltages over the range of input supply voltages. This results in stable operating characteristics over the range of input supply voltages. I²C or SPI digital protocol is used to communicate with the chip to configure and check for updates to the orientation, Directional-Tap™/Double-Tap™ detection, Free fall detection, Pedometer and activity monitoring algorithms.

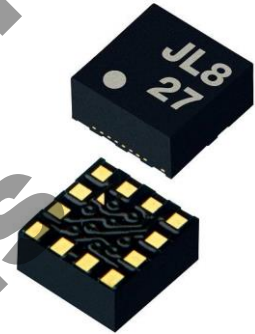

Features

- Small footprint: 2 x 2 x 0.9 mm LGA 12-pin package
- User-configurable g-range up to $\pm 8g$ and Output Data Rate up to 25600Hz
- Integrated pedometer (step counter) with overflow, watermark, and increment interrupts
- High resolution Wake-Up/Back-to-Sleep functions with threshold configurable down to 3.9 mg
- User accessible manufacturer and part ID registers
- Integrated Free fall, Directional-Tap™/Double-Tap™, and Device-orientation Algorithms
- Improved ODR accuracy in Low Power mode over temperature
- Factory Programmed Offset and Sensitivity with improved performance over temperature
- Extra-large embedded 2048-byte FIFO/FILO buffer continues to record data even when being read
- Low Power Consumption with FlexSet™ Performance Optimization
- User-selectable Low Power or High Resolution modes
- Internal voltage regulator
- Digital I²C up to 3.4MHz and Digital SPI up to 10MHz
- RoHS / REACH compliant
- Excellent temperature performance with high shock survivability
- Self-test Function
- Digital High-Pass Filter Outputs



± 2g / 4g / 8g Tri-axis Digital Accelerometer Specifications

PART NUMBER:
KX127-1068
Rev. 2.0
05-Jun-2019

Table of Contents

PRODUCT DESCRIPTION	1
FEATURES	1
TABLE OF CONTENTS	2
FUNCTIONAL DIAGRAM	6
PRODUCT SPECIFICATIONS	7
MECHANICAL	7
ELECTRICAL	8
<i>Start Up Time Profile</i>	9
<i>Current Profile</i>	9
<i>Power-On Procedure</i>	10
ENVIRONMENTAL	11
<i>Handling, Mounting, Soldering</i>	11
<i>Floor Life</i>	11
TERMINOLOGY	12
FUNCTIONALITY	13
APPLICATION SCHEMATIC AND PIN DESCRIPTION	14
<i>Application Schematic</i>	14
<i>Pin Description</i>	14
PACKAGE DIMENSIONS AND ORIENTATION	15
<i>Dimensions</i>	15
<i>Orientation</i>	16
DIGITAL INTERFACE	18
I ² C SERIAL INTERFACE	18
<i>I²C Operation</i>	19
<i>Writing to an 8-bit Register</i>	20
<i>Reading from an 8-bit Register</i>	21
<i>Data Transfer Sequences</i>	22
<i>HS-mode</i>	23
<i>I²C Timing Diagram</i>	24
SPI COMMUNICATIONS	25
<i>4-Wire SPI Interface</i>	25
<i>4-Wire SPI Timing Diagram</i>	26
<i>4-Wire Read and Write Registers</i>	27
<i>3-Wire SPI Interface</i>	28
<i>3-Wire SPI Timing Diagram</i>	29
<i>3-Wire Read and Write Registers</i>	30
EMBEDDED REGISTERS	31
ACCELEROMETER OUTPUTS	32
MAN_ID	33
PART_ID	33
XHP_L	33



± 2g / 4g / 8g Tri-axis Digital Accelerometer Specifications

PART NUMBER:
KX127-1068
Rev. 2.0
05-Jun-2019

XHP_H	33
YHP_L	34
YHP_H	34
ZHP_L	34
ZHP_H	34
XOUT_L	35
XOUT_H	35
YOUT_L	35
YOUT_H	35
ZOUT_L	36
ZOUT_H	36
PED_STP_L AND PED_STP_H	37
COTR	37
WHO_AM_I	37
TSCP	38
TSPP	38
INS1	39
INS2	39
INS3	41
STAT	42
INT_REL	43
CNTL1	43
CNTL2	44
CNTL3	46
CNTL4	47
CNTL5	49
ODCNTL	50
INC1	52
INC2	53
INC3	54
INC4	55
INC5	56
INC6	57
INC7	58
TILT_TIMER	59
TDTRC	59
TDTC	60
TTH	60
TTL	61
FTD	61
STD	62
TLT	62
TWS	63
FFTH	63



± 2g / 4g / 8g Tri-axis Digital Accelerometer Specifications

PART NUMBER:
KX127-1068
Rev. 2.0
05-Jun-2019

FFC	63
FFCNTL	64
TILT_ANGLE_LL	65
TILT_ANGLE_HL	65
HYST_SET	65
LP_CNTL	66
WUFTH, BTSWUFTH AND BTSTH	67
BTSC	67
WUFC	68
PED_STPWM_L AND PED_STPWM_H	68
PED_CNTL1	68
PED_CNTL2	69
PED_CNTL3	70
PED_CNTL4	71
PED_CNTL5	72
PED_CNTL6	72
PED_CNTL7	72
PED_CNTL8	73
PED_CNTL9	73
PED_CNTL10	73
SELF_TEST	74
BUF_CNTL1	75
BUF_CNTL2	76
BUF_STATUS_1 AND BUF_STATUS_2	77
BUF_CLEAR	77
BUF_READ	78
EMBEDDED APPLICATIONS	79
ORIENTATION DETECTION FEATURE	79
<i>Hysteresis</i>	79
<i>Device Orientation Angle (aka Tilt Angle)</i>	80
<i>Tilt Timer</i>	81
MOTION INTERRUPT FEATURE DESCRIPTION	82
<i>Wake-Up function</i>	82
<i>Back-to-Sleep function</i>	84
DIRECTIONAL-TAP DETECTION FEATURE DESCRIPTION	86
<i>Performance Index</i>	86
<i>Single Tap Detection</i>	87
<i>Double-Tap Detection</i>	88
FREE FALL DETECT	89
SAMPLE BUFFER FEATURE DESCRIPTION	91
<i>FIFO Mode</i>	91
<i>Stream Mode</i>	91
<i>Trigger Mode</i>	92
<i>FILO Mode</i>	92



± 2g / 4g / 8g Tri-axis Digital Accelerometer Specifications

PART NUMBER:
KX127-1068
Rev. 2.0
05-Jun-2019

Buffer Operation..... 92
PEDOMETER (STEP COUNTER) FEATURE 98
REVISION HISTORY.....99
APPENDIX100

Not Recommended for New Designs



± 2g / 4g / 8g Tri-axis Digital Accelerometer Specifications

PART NUMBER:
KX127-1068
Rev. 2.0
05-Jun-2019

Functional Diagram

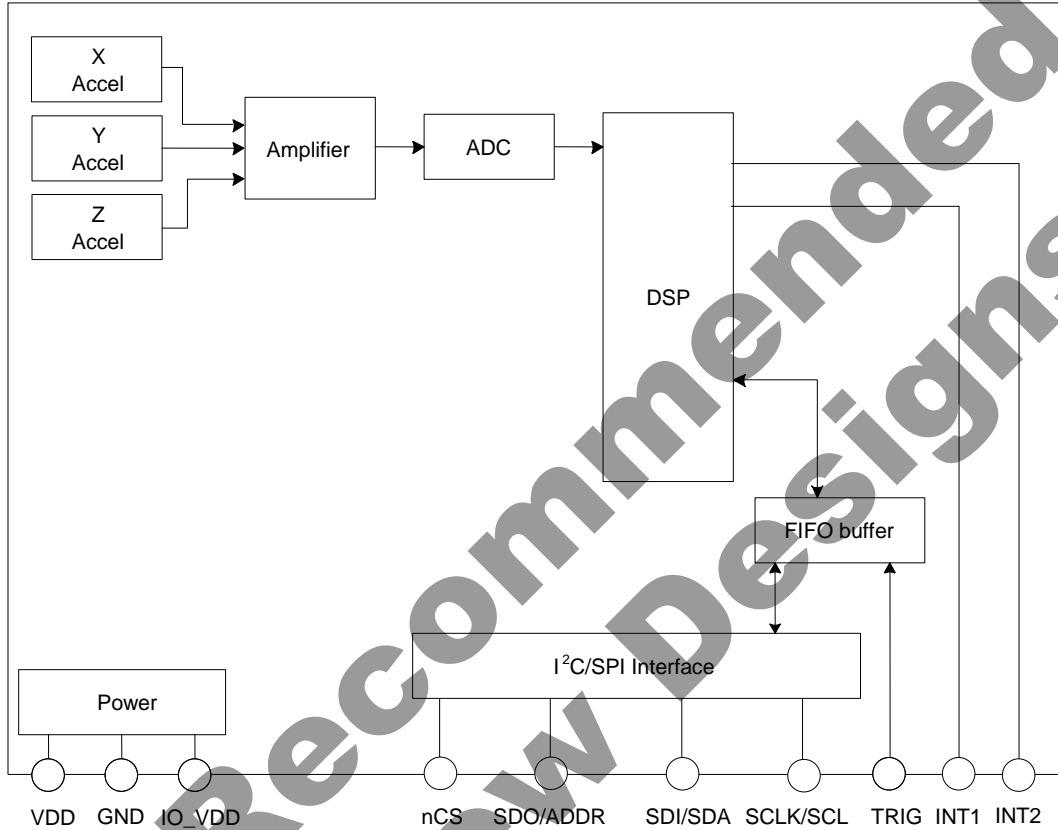



± 2g / 4g / 8g Tri-axis Digital Accelerometer Specifications

PART NUMBER:
KX127-1068
Rev. 2.0
05-Jun-2019

Product Specifications

Mechanical

(specifications are for operation at 2.5V and T = 25C unless stated otherwise)

Parameters		Units	Min	Typical	Max
Operating Temperature Range		°C	-40	-	+85
Zero-g Offset		mg		±25	±90
Zero-g Offset Variation from RT over Temp.		mg/°C		0.2	
Sensitivity ¹ (16 bit)	GSEL1=0, GSEL0=0 (± 2g)	counts/g	15401	16384	17367
	GSEL1=0, GSEL0=1 (± 4g)		7700	8192	8684
	GSEL1=1, GSEL0=0 (± 8g)		3850	4096	4342
Sensitivity (Buffer 8-bit mode) ^{1,2}	GSEL1=0, GSEL0=0 (± 2g)	counts/g	60	64	68
	GSEL1=0, GSEL0=1 (± 4g)		30	32	34
	GSEL1=1, GSEL0=0 (± 8g)		15	16	17
Sensitivity Variation from RT over Temp.		%/°C		0.01	
Positive Self Test Output change on Activation ⁴		g	0.25 (xy) 0.2 (z)	0.5	0.75
Mechanical Signal Bandwidth (-3dB) ⁶		Hz		4000 (xy) 2800 (z)	
Non-Linearity		% of FS		0.6	
Cross Axis Sensitivity		%		2	
Noise ^{3,5}	RMS	mg		0.7	
	Density	µg/√Hz		130	

Table 1: Mechanical Specifications

Notes:

1. Resolution and acceleration ranges are user selectable via I²C or SPI.
2. Sensitivity is proportional to BRES in BUF_CNTL2.
3. Noise varies with Output Data Rate (ODR), and the Average Filter Control settings and can be tested using Kionix FlexSet™ Performance Optimization Tool found at <http://www.kionix.com/flexset>.
4. Requires changing of STPOL bit in INC1 register to 1 prior to performing self-test
5. Measured with ODR=50Hz, IIR_BYPASS=0, LPRO=1 (filter corner frequency set to ODR/2)
6. Signal bandwidth varies with Output Data Rate (ODR), and Low Pass Filter setting. Measured with ODR = 25600Hz, LPRO = 1 settings.



± 2g / 4g / 8g Tri-axis Digital Accelerometer Specifications

PART NUMBER:
KX127-1068
Rev. 2.0
05-Jun-2019

Electrical

(specifications are for operation at 2.5V and T = 25C unless stated otherwise)

Parameters		Units	Min	Typical	Max
Supply Voltage (VDD)	Operating	V	1.71	2.5	3.6
I/O Pads Supply Voltage (IO_VDD)		V	1.7		3.6
Current Consumption	High Resolution Mode (RES = 1)	µA		145	
	Low Power Mode ¹ (RES = 0)			10	
	Standby			0.9	
Output Low Voltage (IO_VDD < 2V) ²		V	-	-	0.2 * IO_VDD
Output Low Voltage (IO_VDD ≥ 2V) ²		V	-	-	0.4
Output High Voltage		V	0.8 * IO_VDD	-	-
Input Low Voltage		V	-	-	0.2 * IO_VDD
Input High Voltage		V	0.8 * IO_VDD	-	-
Start Up Time ³		ms	2		1300
Power Up Time ⁴		ms		20	50
I ² C Communication Rate		MHz			3.4
I ² C Slave Address (7-bit)				0x1E / 0x1F	
WHO_AM_I register value				0x3B	
SPI Communication Rate		MHz			10
Output Data Rate (ODR) ⁵		Hz	0.781	50	25600
Output Signal Bandwidth (-3dB) ⁶		Hz		ODR/9 or ODR/2	

Table 2: Electrical Specifications

Notes:

1. Current varies with Output Data Rate (ODR) as shown in Figure 2, types and number of enabled digital engines, and the Average Filter Control settings that can be tested using Kionix FlexSet™ Performance Optimization Tool found at <http://www.kionix.com/flexset>.
2. For I²C communication, this assumes a minimum 1.5kΩ pull-up resistor on SCL and SDA pins.
3. Start up time is from PC1 set to valid outputs. Time varies with Output Data Rate (ODR) and power mode setting. See Figure 1 for details.
4. Power up time is from VDD valid to device boot completion.
5. User selectable through I²C or SPI.
6. User selectable and dependent on ODR. See ODCNTL register description for details.



± 2g / 4g / 8g Tri-axis Digital Accelerometer Specifications

PART NUMBER:
KX127-1068
Rev. 2.0
05-Jun-2019

Start Up Time Profile

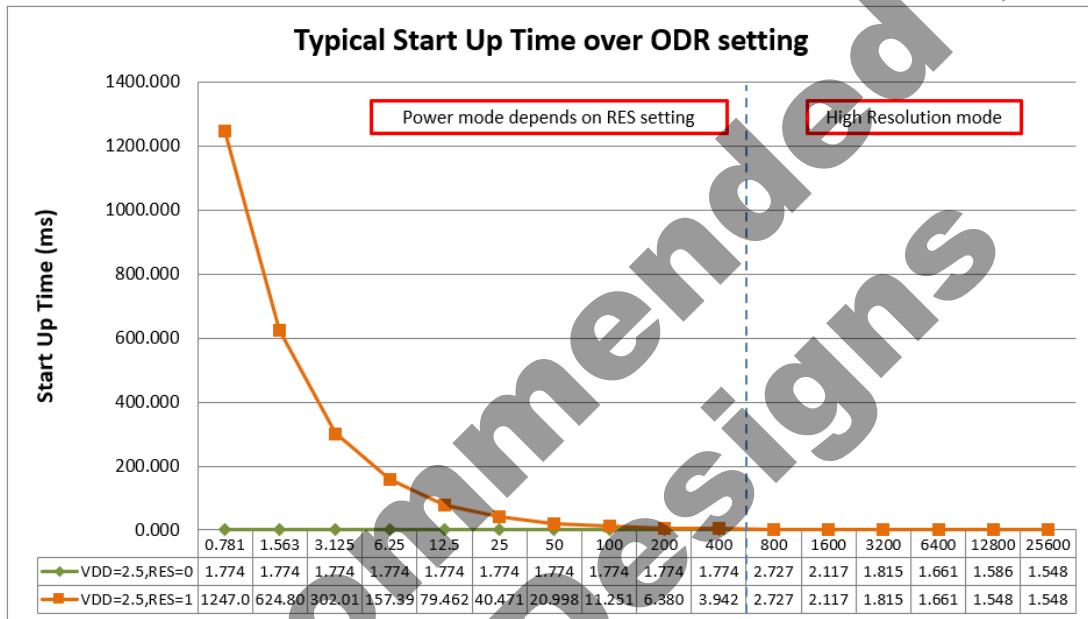

Figure 1: Start Up Time as a function of the Output Data Rate (ODR) and Power Mode Settings

Current Profile

Typical Current Profile (µA)		
ODR (Hz)	High Res	Low Power
Standby	0.9	0.9
0.781	145	1.8
1.563	145	2.0
3.125	145	2.2
6.25	145	3.0
12.5	145	5
25	145	7
50	145	13
100	145	21
200	145	43
400	145	66
800	145	145
1600	145	145
3200	145	145
6400	145	145
12800	145	145
25600	145	145

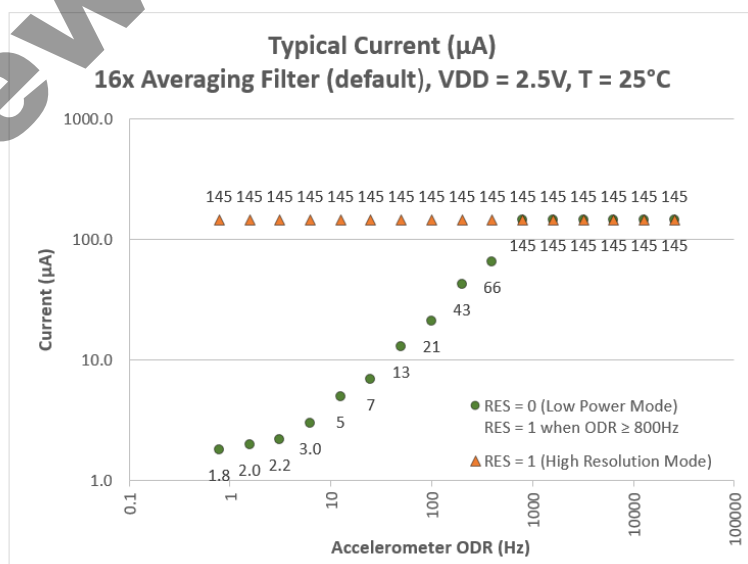

Figure 2: Current as a function of Output Data Rate (ODR) and Power Mode Settings



± 2g / 4g / 8g Tri-axis Digital Accelerometer Specifications

PART NUMBER:

KX127-1068

Rev. 2.0

05-Jun-2019

Power-On Procedure

Proper functioning of power-on reset (POR) is dependent on the specific **VDD**, **VDD_{LOW}**, **T_{VDD}** (rise time), and **T_{VDD_OFF}** profile of individual applications. It is recommended to minimize **VDD_{LOW}**, and **T_{VDD}**, and maximize **T_{VDD_OFF}**. It is also advised that the **VDD** ramp up time **T_{VDD}** be monotonic. Note that the outputs will not be stable until **VDD** has reached its final value.

- ! To assure proper POR, the application should be evaluated over the customer specified range of **VDD**, **VDD_{LOW}**, **T_{VDD}**, **T_{VDD_OFF}** and temperature as POR performance can vary depending on these parameters.

Please refer to Technical Note [TN021 Power-On Procedure](#) for more information.

Not Recommended for New Designs

	± 2g / 4g / 8g Tri-axis Digital Accelerometer Specifications	PART NUMBER: KX127-1068 Rev. 2.0 05-Jun-2019
---	---	---

Environmental

Parameters		Units	Min	Typical	Max
Supply Voltage (VDD)	Absolute Limits	V	-0.3	-	3.6
Operating Temperature Range		°C	-40	-	+85
Storage Temperature Range		°C	-55	-	150
Mech. Shock (powered and unpowered)		g	-	-	5000 for 0.5ms 10000 for 0.2ms
ESD	HBM	V	-	-	2000

Table 3: Environmental Specifications



Caution: ESD Sensitive and Mechanical Shock Sensitive Component, improper handling can cause permanent damage to the device.



This product is in conformance with RoHS directive, REACH regulation, and is Halogen-Free. For the current certificate of compliance, visit www.kionix.com website.

Handling, Mounting, Soldering

For package handling, mounting, and soldering guidelines, see [TN007 Package Handling, Mounting, and Soldering Guidelines](#) technical note.

Floor Life

Factory floor life exposure of the KX127-1068 reels removed from the moisture barrier bag should not exceed a maximum of 168 hours at 30C/60%RH. If this floor life is exceeded, the parts should be dried per the IPC/JEDEC J-STD-033D standard (or latest revision).



± 2g / 4g / 8g Tri-axis Digital Accelerometer Specifications

PART NUMBER:

KX127-1068

Rev. 2.0

05-Jun-2019

Terminology

g

A unit of acceleration equal to the acceleration of gravity at the earth's surface. One thousandth of a g (0.0098 m/s²) is referred to as 1 milli-g (1 mg).

$$1g = 9.8 \frac{m}{s^2}$$

Sensitivity

The sensitivity of an accelerometer is the change in output per unit of input acceleration at nominal VDD and temperature. The term is essentially the gain of the sensor expressed in counts per g (counts/g) or LSB's per g (LSB/g). Occasionally, sensitivity is expressed as a resolution, i.e. milli-g per LSB (mg/LSB) or milli-g per count (mg/count). Sensitivity for a given axis is determined by measurements of the formula:

$$Sensitivity = \frac{(Output@+1g - Output@-1g)}{2g}$$

The sensitivity tolerance describes the range of sensitivities that can be expected from a large population of sensors at room temperature and over life. When the temperature deviates from room temperature (25°C), the sensitivity will vary by the amount shown in Table 1.

Zero-g offset

Zero-g offset or 0-g offset describes the actual output of the accelerometer when no acceleration is applied. Ideally, the output would always be in the middle of the dynamic range of the sensor (content of the XOUT, YOUT, ZOUT registers = 0x00, expressed as a 2's complement number). However, because of mismatches in the sensor, calibration errors, and mechanical stress, the output can deviate from 00. This deviation from the ideal value is called 0-g offset. The zero-g offset tolerance describes the range of 0-g offsets of a population of sensors over the operating temperature range.

Self-test

Self-test allows a functional test of the sensor without applying a physical acceleration to it. When activated, an electrostatic force is applied to the sensor, simulating an input acceleration. The sensor outputs respond accordingly. The self test response should be compared to the product specifications to determine if the MEMS response is within the specified range as indicated in Mechanical Specification table.



± 2g / 4g / 8g Tri-axis Digital Accelerometer Specifications

PART NUMBER:

KX127-1068

Rev. 2.0

05-Jun-2019

Functionality

Sense element

The sense element is fabricated using Kionix's proprietary plasma micromachining process technology. This process technology allows Kionix to create mechanical silicon structures which are essentially mass-spring systems that move in the direction of the applied acceleration. Acceleration sensing is based on the principle of a differential capacitance arising from the acceleration-induced motion. Capacitive plates on the moving mass move relative to fixed capacitive plates anchored to the substrate. The sense element is hermetically sealed at the wafer level by bonding a second silicon lid wafer to the device using a glass frit.

ASIC interface

A separate ASIC device packaged with the sense element provides all of the signal conditioning and communication with the sensor. The complete measurement chain is composed by a low-noise capacitance to voltage amplifier which converts the differential capacitance of the MEMS sensor into an analog voltage that is sent through an analog-to-digital converter. The acceleration data may be accessed through the I²C or SPI digital communications provided by the ASIC. In addition, the ASIC contains all of the logic to allow the user to choose data rates, g-ranges, filter settings, and interrupt logic.

Factory calibration

Kionix trims the offset and sensitivity of each accelerometer by adjusting gain (sensitivity) and 0-g offset trim codes stored in nonvolatile memory (OTP). Additionally, all functional register default values are also programmed into the nonvolatile memory. Every time the device is turned on or a software reset command is issued, the trimming parameters and default register values are downloaded into the volatile registers to be used during active operation. This allows the device to function without further calibration.



± 2g / 4g / 8g Tri-axis Digital Accelerometer Specifications

PART NUMBER:
KX127-1068
Rev. 2.0
05-Jun-2019

Application Schematic and Pin Description

Application Schematic

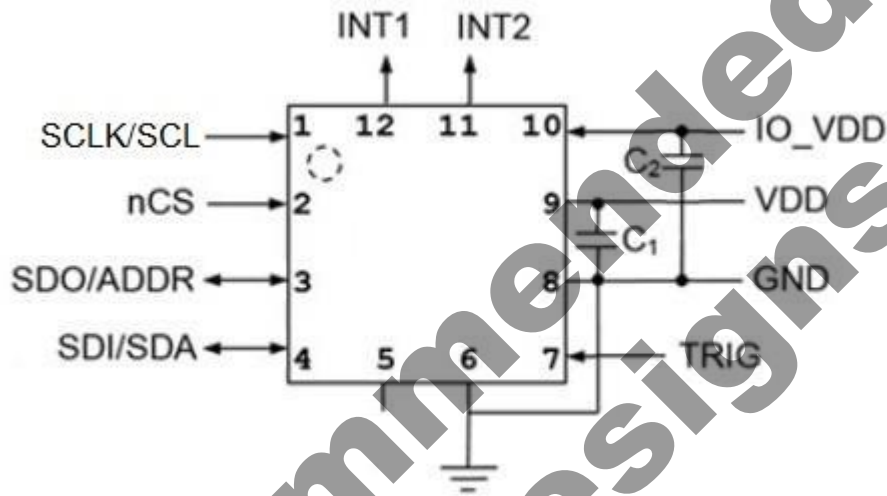

Pin Description

Pin	Name	Description
1	SCLK/SCL	SPI and I2C Serial Clock
2	nCS	Chip Select (active LOW) for SPI communication. Connect to IO_VDD for I2C communication. Do not leave floating.
3	SDO/ADDR	Serial Data Out pin during 4 wire SPI communication and part of the device address during I2C communication. Do not leave floating.
4	SDI/SDA	SPI Data input / I2C Serial Data
5	NC	Not Internally Connected - Can be connected to VDD, IO_VDD, GND or leave floating.
6	GND	Ground
7	TRIG	Trigger pin for FIFO buffer control - Connect to GND when not using external trigger option.
8	GND	Ground
9	VDD	The power supply input. Decouple this pin to ground with a 0.1uF ceramic capacitor.
10	IO_VDD	The power supply input for the digital communication bus. Optionally decouple this pin to ground with a 0.1uF ceramic capacitor.
11	INT2	Physical Interrupt 2 (Push-Pull). The pin is in High-Z state during POR and is driven LOW following POR. Leave floating if not used.
12	INT1	Physical Interrupt 1 (Push-Pull). The pin is in High-Z state during POR and is driven LOW following POR. Leave floating if not used.

Table 4: Pin Description



± 2g / 4g / 8g Tri-axis Digital Accelerometer Specifications

PART NUMBER:
KX127-1068
Rev. 2.0
05-Jun-2019

Package Dimensions and Orientation

Dimensions

2 x 2 x 0.9 mm LGA

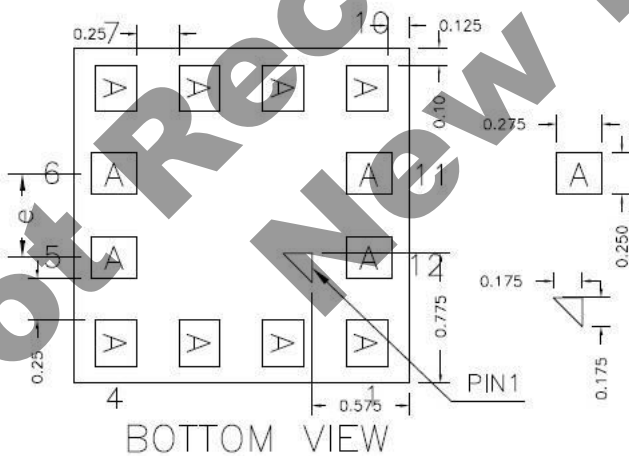
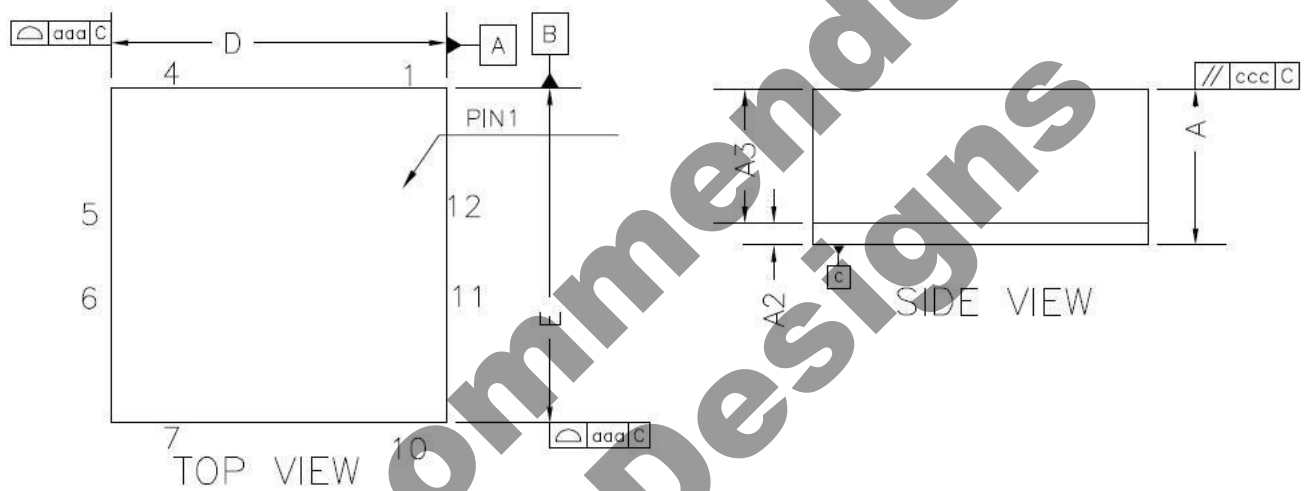

MILLIMETER			
SYMBOL	MIN	NOR	MAX
A	0.86	0.93	1.00
A2	0.10	0.13	0.16
A3	0.76	0.80	0.84
D	1.95	2.00	2.05
E	1.95	2.00	2.05
e	BSC 0.50		
aaa	0.10		
ccc	0.05		

PO-WJA220012-S7_01

All dimensions and tolerances conform to ASME Y14.5M-1994



± 2g / 4g / 8g Tri-axis Digital Accelerometer Specifications

PART NUMBER:
KX127-1068
Rev. 2.0
05-Jun-2019

Orientation

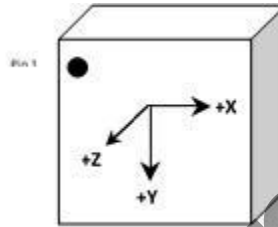

When device is accelerated in +X, +Y or +Z direction, the corresponding output will increase.

Static X/Y/Z Output Response versus Orientation to Earth's surface (1g): GSEL1=0, GSEL0=0 (±2g)

Position	1		2		3		4		5		6	
Diagram									Top Bottom		Bottom Top	
Resolution (bits)	16	8	16	8	16	8	16	8	16	8	16	8
X (counts)	0	0	+16384	+64	0	0	-16384	-64	0	0	0	0
Y (counts)	-16384	-64	0	0	+16384	+64	0	0	0	0	0	0
Z (counts)	0	0	0	0	0	0	0	0	+16384	+64	-16384	-64
X-Polarity	0		+		0		-		0		0	
Y-Polarity	-		0		+		0		0		0	
Z-Polarity	0		0		0		0		+		-	



Earth's Surface



± 2g / 4g / 8g Tri-axis Digital Accelerometer Specifications

PART NUMBER:
KX127-1068
Rev. 2.0
05-Jun-2019

Static X/Y/Z Output Response versus Orientation to Earth's surface (1g): GSEL1=0, GSEL0=1 (±4g)

Position	1		2		3		4		5		6	
Diagram									Top Bottom		Bottom Top	
Resolution (bits)	16	8	16	8	16	8	16	8	16	8	16	8
X (counts)	0	0	+8192	+32	0	0	-8192	-32	0	0	0	0
Y (counts)	-8192	-32	0	0	+8192	+32	0	0	0	0	0	0
Z (counts)	0	0	0	0	0	0	0	0	+8192	+32	-8192	-32
X-Polarity	0		+		0		-		0		0	
Y-Polarity	-		0		+		0		0		0	
Z-Polarity	0		0		0		0		+		-	



Earth's Surface

Static X/Y/Z Output Response versus Orientation to Earth's surface (1g): GSEL1=1, GSEL0=0 (±8g)

Position	1		2		3		4		5		6	
Diagram									Top Bottom		Bottom Top	
Resolution (bits)	16	8	16	8	16	8	16	8	16	8	16	8
X (counts)	0	0	+4096	+16	0	0	-4096	-16	0	0	0	0
Y (counts)	-4096	-16	0	0	+4096	+16	0	0	0	0	0	0
Z (counts)	0	0	0	0	0	0	0	0	+4096	+16	-4096	-16
X-Polarity	0		+		0		-		0		0	
Y-Polarity	-		0		+		0		0		0	
Z-Polarity	0		0		0		0		+		-	

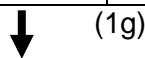

Earth's Surface

	± 2g / 4g / 8g Tri-axis Digital Accelerometer Specifications	PART NUMBER: KX127-1068 Rev. 2.0 05-Jun-2019
---	---	---

Digital Interface

The Kionix KX127 digital accelerometer can communicate via the I²C and SPI digital serial interface protocols. This allows for easy system integration by eliminating analog-to-digital converter requirements and by providing direct communication with system micro-controllers.

The serial interface terms and descriptions as indicated in Table 5 will be observed throughout this document.

Term	Description
Transmitter	The device that transmits data to the bus.
Receiver	The device that receives data from the bus.
Master	The device that initiates a transfer, generates clock signals, and terminates a transfer.
Slave	The device addressed by the Master.

Table 5: Serial Interface Terminologies

I²C Serial Interface

As previously mentioned, the KX127 can communicate on an I²C bus. I²C is primarily used for synchronous serial communication between a Master device and one or more Slave devices. The Master, typically a micro controller, provides the serial clock signal and addresses Slave devices on the bus. The KX127 always operates as a Slave device during standard Master-Slave I²C operation.

I²C is a two-wire serial interface that contains a Serial Clock (SCL) line and a Serial Data (SDA) line. SCL is a serial clock that is provided by the Master, but can be held LOW by any Slave device, putting the Master into a wait condition. SDA is a bi-directional line used to transmit and receive data to and from the interface. Data is transmitted MSB (Most Significant Bit) first in 8-bit per byte format, and the number of bytes transmitted per transfer is unlimited. The I²C bus is considered free when both lines are HIGH.

The I²C interface is compliant with high-speed mode, fast mode and standard mode I²C protocols.



± 2g / 4g / 8g Tri-axis Digital Accelerometer Specifications

PART NUMBER:
KX127-1068
Rev. 2.0
05-Jun-2019

I²C Operation

Transactions on the I²C bus begin after the Master transmits a start condition (S), which is defined as a HIGH-to-LOW transition on the data line while the SCL line is held HIGH. The bus is considered busy after this condition. The next byte of data transmitted after the start condition contains the Slave Address (SAD) in the seven MSBs (Most Significant Bits), and the LSB (Least Significant Bit) tells whether the Master will be receiving data '1' from the Slave or transmitting data '0' to the Slave. When a Slave Address is sent, each device on the bus compares the seven MSBs with its internally stored address. If they match, the device considers itself addressed by the Master. The KX127 Slave Address is comprised of a user programmable part, a factory programmable part, and a fixed part, which allows for connection of multiple accelerometers to the same I²C bus. The Slave Address associated with the KX127 is 00111YX, where the user programmable bit X, is determined by the assignment of ADDR pin to GND or IO_VDD. Also, the factory programmable bit Y is set at the factory. **For KX127-1068, the factory programmable bit Y is fixed to 1** (contact your Kionix sales representative for list of available devices). Table 6 lists possible I²C addresses for KX127-1068. It is possible to have up to four accelerometers on a shared I²C bus as shown in Figure 3 (i.e. two KX127-1068 accelerometers and two additional accelerometers with the factory programmable bit Y set to 0).

Description	Address Pad	7-bit Address	Address	<7>	<6>	<5>	<4>	<3>	Y		X	
									<2>	<1>	<0>	<0>
I2C Wr	GND	0x1E	0x3C	0	0	1	1	1	1	0	0	0
I2C Rd	GND	0x1E	0x3D	0	0	1	1	1	1	0	1	1
I2C Wr	IO_VDD	0x1F	0x3E	0	0	1	1	1	1	1	1	0
I2C Rd	IO_VDD	0x1F	0x3F	0	0	1	1	1	1	1	1	1

Table 6: I²C Slave Addresses for KX127-1068

It is mandatory that receiving devices acknowledge (ACK) each transaction. Therefore, the transmitter must release the SDA line during this ACK pulse. The receiver then pulls the data line LOW so that it remains stable LOW during the HIGH period of the ACK clock pulse. A receiver that has been addressed, whether it is Master or Slave, is obliged to generate an ACK after each byte of data has been received. To conclude a transaction, the Master must transmit a stop condition (P) by transitioning the SDA line from LOW to HIGH while SCL is HIGH. The I²C bus is now free. Note that if the KX127 is accessed through I²C protocol before the startup is finished a NACK signal is sent.



± 2g / 4g / 8g Tri-axis Digital Accelerometer Specifications

PART NUMBER:
KX127-1068
Rev. 2.0
05-Jun-2019

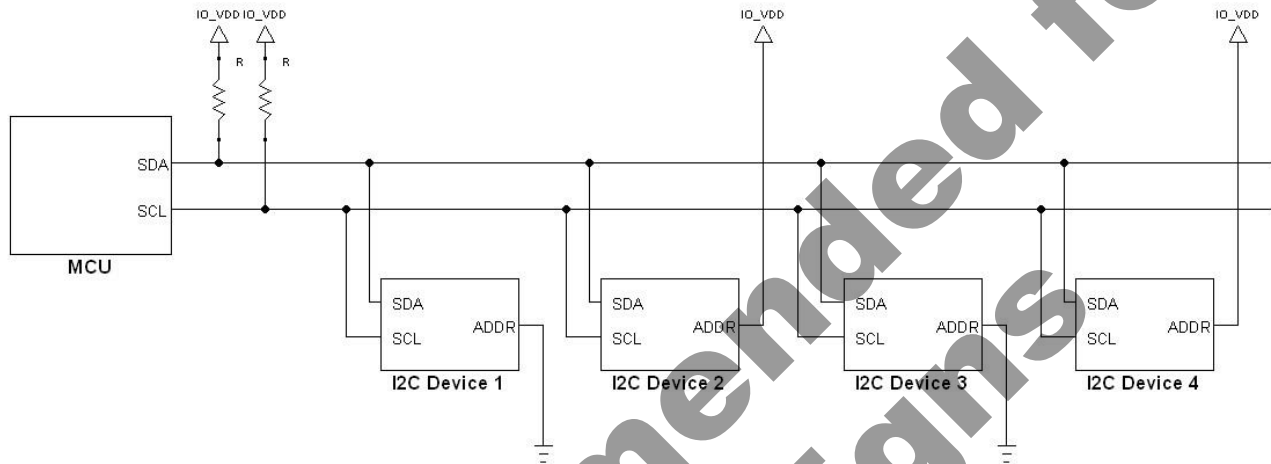

I2C Device	Part Number	ADDR Pin	Slave Address	Bit Y (Bit 1 in 7-bit address)
1	KX127-1068	GND	0x1E	Factory Set to 1
2	KX127-1068	IO_VDD	0x1F	Factory Set to 1
3	*KXMMM	GND	0x1C	Factory Set to 0
4	*KXMMM	IO_VDD	0x1D	Factory Set to 0

* KXMMM – contact Kionix sales representative for list of compatible devices

Figure 3: Multiple KX127 Accelerometers on a Shared I²C Bus

Writing to an 8-bit Register

Upon power up, the Master must write to the KX127's control registers to set its operational mode. Therefore, when writing to a control register on the I²C bus, as shown Sequence 1, the following protocol must be observed: After a start condition, SAD+W transmission, and the KX127 ACK has been returned, an 8-bit Register Address (RA) command is transmitted by the Master. This command is telling the KX127 to which 8-bit register the Master will be writing the data. Since this is I²C mode, the LSB of the RA command should always be zero (0). The KX127 acknowledges the RA and the Master transmits the data to be stored in the 8-bit register. The KX127 acknowledges that it has received the data and the Master transmits a stop condition (P) to end the data transfer. The data sent to the KX127 is now stored in the appropriate register. The KX127 automatically increments the received RA commands and, therefore, multiple bytes of data can be written to sequential registers after each Slave ACK as shown in Sequence 2.

****Note**** If a STOP condition is sent on the least significant bit of write data or the following master acknowledge cycle, the last write operation is not guaranteed and it may alter the content of the affected registers.

	± 2g / 4g / 8g Tri-axis Digital Accelerometer Specifications	PART NUMBER: KX127-1068 Rev. 2.0 05-Jun-2019
---	---	---

Reading from an 8-bit Register

When reading data from a KX127 8-bit register on the I²C bus, as shown in Sequence 3 on the next page, the following protocol must be observed: The Master first transmits a start condition (S) and the appropriate Slave Address (SAD) with the LSB set at '0' to write. The KX127 acknowledges and the Master transmits the 8-bit RA of the register it wants to read. The KX127 again acknowledges, and the Master transmits a repeated start condition (Sr). After the repeated start condition, the Master addresses the KX127 with a '1' in the LSB (SAD+R) to read from the previously selected register. The Slave then acknowledges and transmits the data from the requested register. The Master does not acknowledge (NACK) it received the transmitted data, but transmits a stop condition to end the data transfer. Note that the KX127 automatically increments through its sequential registers, allowing data to be read from multiple registers following a single SAD+R command as shown below in Sequence 4 on the following page. Reading data from a buffer read register is a special case because if register address (RA) is set to buffer read register (BUF_READ) in Sequence 4, the register auto-increment feature is automatically disabled. Instead, the Read Pointer will increment to the next data in the buffer, thus allowing reading multiple bytes of data from the buffer using a single SAD+R command.

****Note**** Accelerometer's output data should be read in a single transaction using the auto-increment feature to prevent output data from being updated prior to intended completion of the read transaction.

Not Recommended for New Designs



± 2g / 4g / 8g Tri-axis Digital Accelerometer Specifications

PART NUMBER:
KX127-1068
Rev. 2.0
05-Jun-2019

Data Transfer Sequences

The following information clearly illustrates the variety of data transfers that can occur on the I²C bus and how the Master and Slave interact during these transfers. Table 7 defines the I²C terms used during the data transfers.

Term	Definition
S	Start Condition
Sr	Repeated Start Condition
SAD	Slave Address
W	Write Bit
R	Read Bit
ACK	Acknowledge
NACK	Not Acknowledge
RA	Register Address
Data	Transmitted/Received Data
P	Stop Condition

Table 7: I²C Terms

Sequence 1: The Master is writing one byte to the Slave.

Master	S	SAD + W		RA		DATA		P
Slave			ACK		ACK			ACK

Sequence 2: The Master is writing multiple bytes to the Slave.

Master	S	SAD + W		RA		DATA		DATA		P
Slave			ACK		ACK			ACK		ACK

Sequence 3: The Master is receiving one byte of data from the Slave.

Master	S	SAD + W		RA		Sr	SAD + R			NACK	P
Slave			ACK		ACK			ACK	DATA		

Sequence 4: The Master is receiving multiple bytes of data from the Slave.

Master	S	SAD + W		RA		Sr	SAD + R			ACK		NACK	P
Slave			ACK		ACK			ACK	DATA		DATA		



± 2g / 4g / 8g Tri-axis Digital Accelerometer Specifications

PART NUMBER:
KX127-1068
Rev. 2.0
05-Jun-2019

HS-mode

To enter the 3.4MHz high speed mode of communication, the device must receive the following sequence of conditions from the master: a Start condition followed by a Master code (00001XXX) and a Master Non-acknowledge. Once recognized, the device switches to HS-mode communication. Read/write data transfers then proceed as described in the sequences above. Devices return to the FS-mode after a STOP occurrence on the bus.

Sequence 5: HS-mode data transfer of the Master writing multiple bytes to the Slave.

Speed	FS-mode			HS-mode								FS-mode
Master	S	M-code	NACK	Sr	SAD + W		RA		DATA		P	
Slave						ACK		ACK		ACK		

n bytes + ack.

Sequence 6: HS-mode data transfer of the Master receiving multiple bytes of data from the Slave.

Speed	FS-mode			HS-mode			
Master	S	M-code	NACK	Sr	SAD + W		RA
Slave						ACK	ACK

Speed	HS-mode							FS-mode
Master	Sr	SAD + R					NACK	P
Slave			ACK	DATA	ACK	DATA		

(n-1) bytes + ack.



± 2g / 4g / 8g Tri-axis Digital Accelerometer Specifications

PART NUMBER:
KX127-1068
Rev. 2.0
05-Jun-2019

I²C Timing Diagram

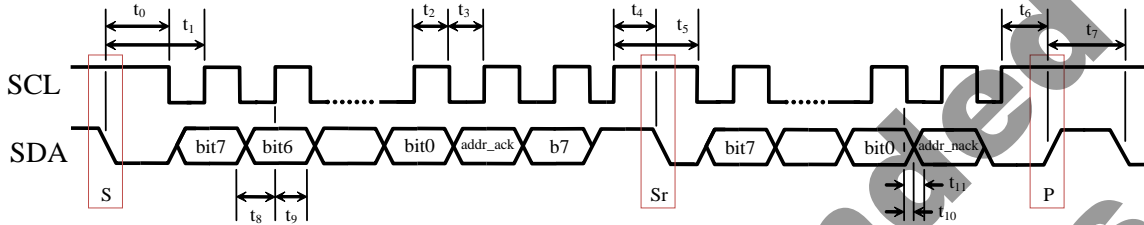

Number	Description	MIN	MAX	Units
t ₀	SDA LOW to SCL LOW transition (Start event)	50	-	ns
t ₁	SDA LOW to first SCL rising edge	100	-	ns
t ₂	SCL pulse width: HIGH	100	-	ns
t ₃	SCL pulse width: LOW	100	-	ns
t ₄	SCL HIGH before SDA falling edge (Start Repeated)	50	-	ns
t ₅	SCL pulse width: HIGH during a S/Sr/P event	100	-	ns
t ₆	SCL HIGH before SDA rising edge (Stop)	50	-	ns
t ₇	SDA pulse width: HIGH	25	-	ns
t ₈	SDA valid to SCL rising edge	50	-	ns
t ₉	SCL rising edge to SDA invalid	50	-	ns
t ₁₀	SCL falling edge to SDA valid (when slave is transmitting)	-	100	ns
t ₁₁	SCL falling edge to SDA invalid (when slave is transmitting)	0	-	ns
Note	Recommended I ² C CLK	2.5	-	μs

Table 8: I²C Timing (Fast Mode)

	± 2g / 4g / 8g Tri-axis Digital Accelerometer Specifications	PART NUMBER: KX127-1068 Rev. 2.0 05-Jun-2019
---	---	---

SPI Communications

4-Wire SPI Interface

The KX127 also utilizes an integrated 4-Wire Serial Peripheral Interface (SPI) for digital communication. The SPI interface is primarily used for synchronous serial communication between one Master device and one or more Slave devices. The Master, typically a micro controller, provides the SPI clock signal (SCLK) and determines the state of Chip Select (nCS). The KX127 always operates as a Slave device during standard Master-Slave SPI operation.

4-wire SPI is a synchronous serial interface that uses two control and two data lines. With respect to the Master, the Serial Clock output (SCLK), the Data Output (SDI or MOSI) and the Data Input (SDO or MISO) are shared among the Slave devices. The Master generates an independent Chip Select (nCS) for each Slave device that goes LOW at the start of transmission and goes back HIGH at the end. The Slave Data Output (SDO) line, remains in a high-impedance (hi-z) state when the device is not selected, so it does not interfere with any active devices. This allows multiple Slave devices to share a master SPI port as shown in Figure 4.

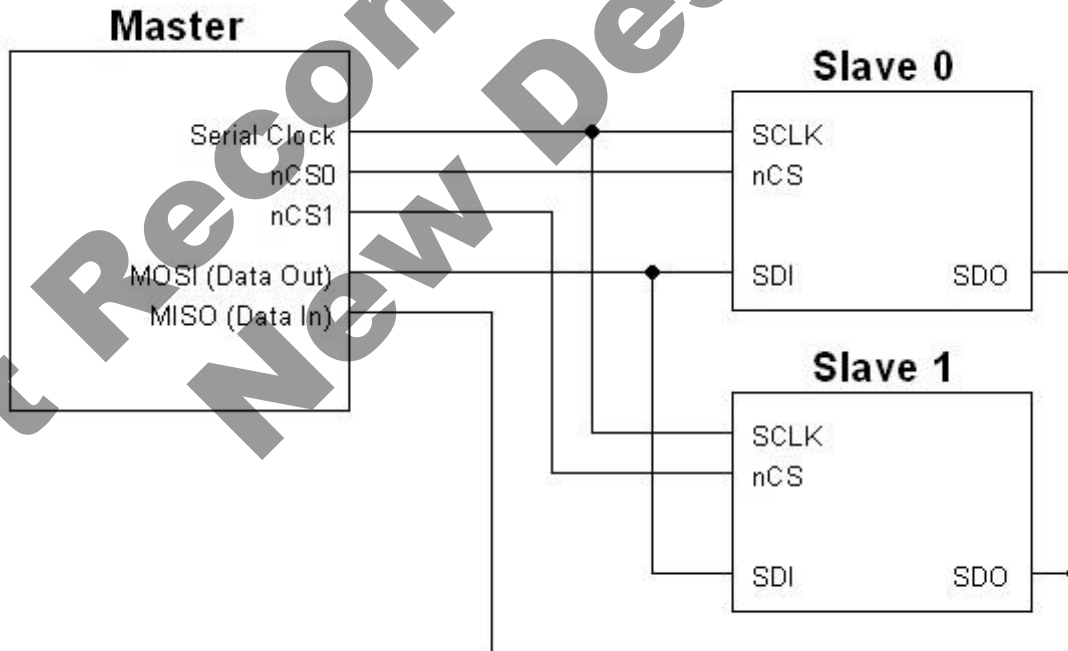

Figure 4. 4-wire SPI Connections



± 2g / 4g / 8g Tri-axis Digital Accelerometer Specifications

PART NUMBER:
KX127-1068
Rev. 2.0
05-Jun-2019

4-Wire SPI Timing Diagram

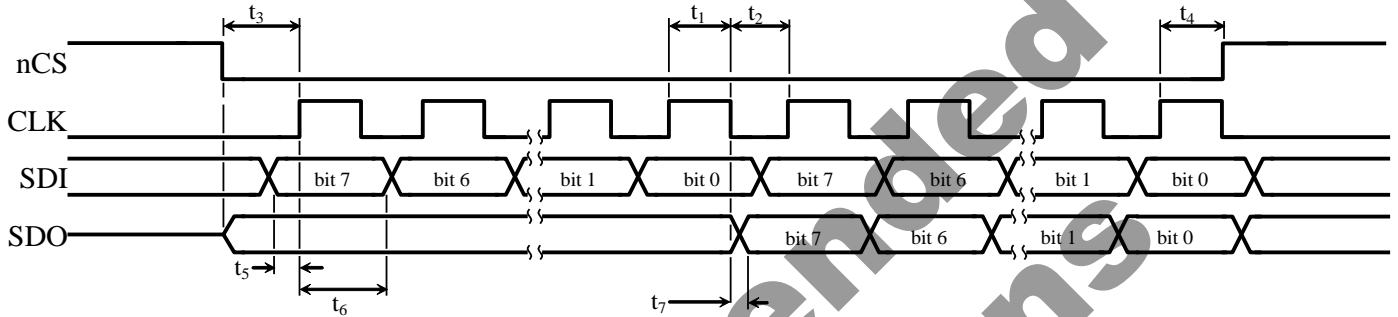

Number	Description	MIN	MAX	Units
t ₁	CLK pulse width: HIGH	45		ns
t ₂	CLK pulse width: LOW	45		ns
t ₃	nCS LOW to first CLK rising edge	20		ns
t ₄	nCS LOW after the final CLK rising edge to nCS HIGH	20		ns
t ₅	SDI valid to CLK rising edge	10		ns
t ₆	CLK rising edge to SDI invalid	10		ns
t ₇	CLK falling edge to SDO valid		35	ns

Table 9: 4-Wire SPI Timing

Notes

1. t₇ is only present during reads.
2. Timings are for VDD of 1.8V to 3.6V with 1kΩ pull-up resistor and maximum 20pF load capacitor on SDO.



± 2g / 4g / 8g Tri-axis Digital Accelerometer Specifications

PART NUMBER:
KX127-1068
Rev. 2.0
05-Jun-2019

4-Wire Read and Write Registers

The registers embedded in the KX127 accelerometer have 8-bit addresses. Upon power up, the Master must write to the accelerometer's control registers to set its operational mode. On the falling edge of nCS, a 2-byte command is written to the appropriate control register. The first byte initiates the write to the appropriate register, and is followed by the user-defined, data byte. The MSB (Most Significant Bit) of the register address byte will indicate "0" when writing to the register and "1" when reading from the register. This operation occurs over 16 clock cycles. All commands are sent MSB first. The host must return nCS HIGH for at least one clock cycle before the next data request. However, when data is being read from a buffer read register (BUF_READ), the nCS signal can remain LOW until the buffer is read. Figure 5 shows the timing diagram for carrying out an 8-bit register write operation.

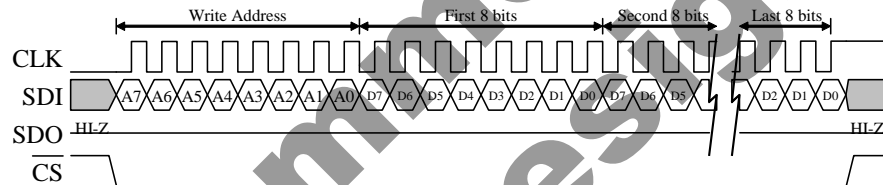

Figure 5: Timing Diagram for 8-Bit Register Write Operation

In order to read an 8-bit register, an 8-bit register address must be written to the accelerometer to initiate the read. The MSB of this register address byte will indicate "0" when writing to the register and "1" when reading from the register. Upon receiving the address, the accelerometer returns the 8-bit data stored in the addressed register. This operation also occurs over 16 clock cycles. All returned data is sent MSB first, and the host must return nCS HIGH for at least one clock cycle before the next data request. Figure 6 shows the timing diagram for an 8-bit register read operation.

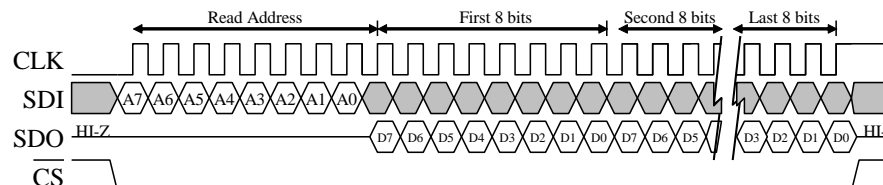

Figure 6: Timing Diagram for 8-Bit Register Read Operation



± 2g / 4g / 8g Tri-axis Digital Accelerometer Specifications

PART NUMBER:
KX127-1068
Rev. 2.0
05-Jun-2019

3-Wire SPI Interface

The KX127 also utilizes an integrated 3-Wire Serial Peripheral Interface (SPI) for digital communication. 3-wire SPI is a synchronous serial interface that uses two control lines and one data line. With respect to the Master, the Serial Clock output (SCLK), the Data Output/Input (SDI) are shared among the Slave devices. The Master generates an independent Chip Select (nCS) for each Slave device that goes LOW at the start of transmission and goes back HIGH at the end. This allows multiple Slave devices to share a master SPI port as shown in Figure 7.

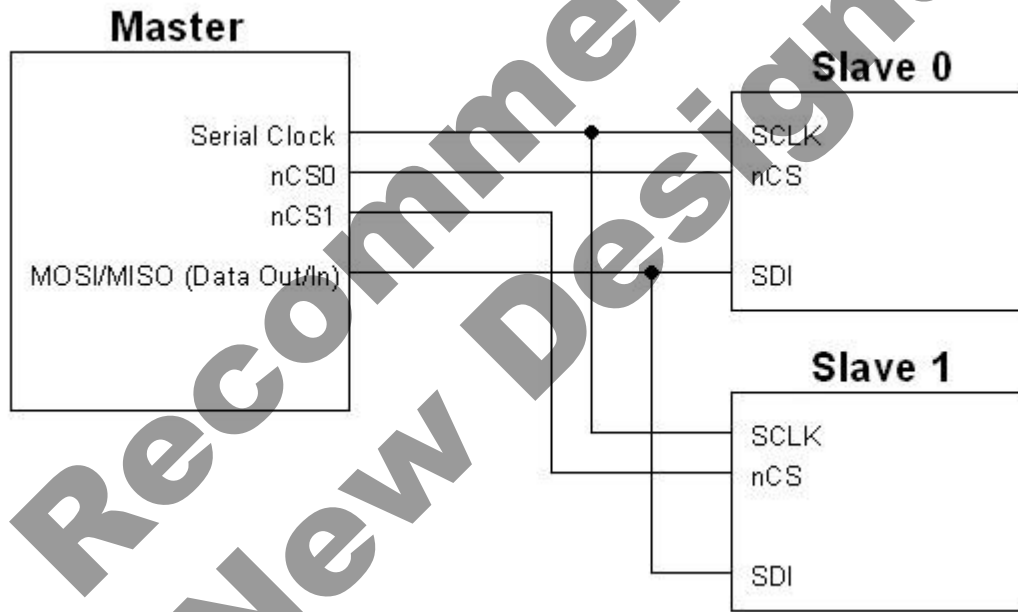

Figure 7: 3-wire SPI Connections



± 2g / 4g / 8g Tri-axis Digital Accelerometer Specifications

PART NUMBER:
KX127-1068
Rev. 2.0
05-Jun-2019

3-Wire SPI Timing Diagram

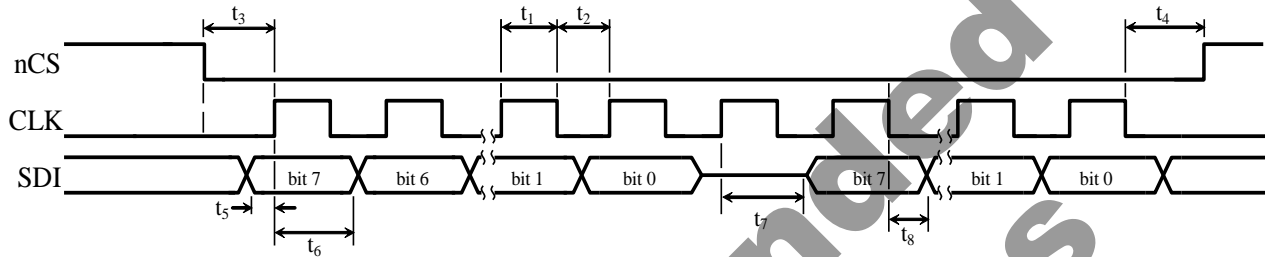

Number	Description	MIN	MAX	Units
t ₁	CLK pulse width: HIGH	45	-	ns
t ₂	CLK pulse width: LOW	45	-	ns
t ₃	nCS LOW to first CLK rising edge	20	-	ns
t ₄	nCS LOW after the final CLK falling edge to nCS HIGH	20	-	ns
t ₅	SDI valid to CLK rising edge	10	-	ns
t ₆	CLK rising edge to SDI input invalid	10	-	ns
t ₇	CLK extra clock cycle rising edge to SDI output becomes valid	-	-	ns
t ₈	CLK falling edge to SDI output becomes valid	-	35	ns

Table 10: 3-Wire SPI Timing

Notes

- t₇ and t₈ are only present during reads
- Timings are for VDD of 1.8V to 3.6V with 1kΩ pull-up resistor and maximum 20pF load capacitor on SDI.
- The SDO/ADDR pin is configured in a high-impedance input-state, and must be externally tied to GND or IO_VDD



± 2g / 4g / 8g Tri-axis Digital Accelerometer Specifications

PART NUMBER:
KX127-1068
Rev. 2.0
05-Jun-2019

3-Wire Read and Write Registers

The registers embedded in the KX127 accelerometer have 8-bit addresses. Upon power up, the Master must write to the accelerometer's control registers to set its operational mode. On the falling edge of nCS, a 2-byte command is written to the appropriate control register. The first byte initiates the write to the appropriate register, and is followed by the user-defined, data byte. The MSB (Most Significant Bit) of the register address byte will indicate "0" when writing to the register and "1" when reading from the register. A read operation occurs over 17 clock cycles and a write operation occurs over 16 clock cycles. All commands are sent MSB first. The host must return nCS HIGH for at least one clock cycle before the next data request. However, when data is being read from a buffer read register (BUF_READ), the nCS signal can remain LOW until the buffer is read. Figure 8 shows the timing diagram for carrying out an 8-bit register write operation.

****NOTE**** If a STOP condition is sent on the least significant bit of write data or the following master acknowledge cycle, the last write operation is not guaranteed and it would cause unexpected register write.

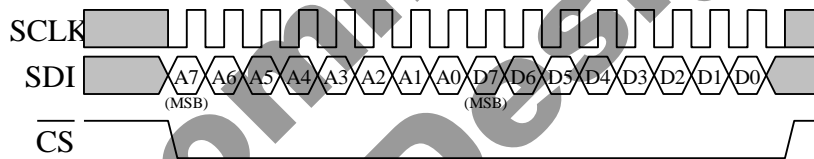

Figure 8: Timing Diagram for 8-Bit Register Write Operation

In order to read an 8-bit register, an 8-bit register address must be written to the accelerometer to initiate the read. The MSB of this register address byte will indicate "0" when writing to the register and "1" when reading from the register. Upon receiving the address, the accelerometer returns the 8-bit data stored in the addressed register. For 3-wire read operations, one extra clock cycle between the address byte and the data output byte is required. Therefore, this operation occurs over 17 clock cycles. All returned data is sent MSB first, and the host must return nCS HIGH for at least one clock cycle before the next data request. Figure 9 shows the timing diagram for an 8-bit register read operation.

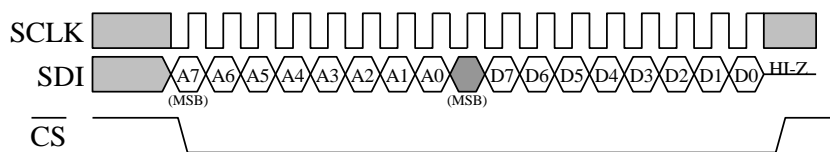

Figure 9: Timing Diagram for 8-Bit Register Read Operation



± 2g / 4g / 8g Tri-axis Digital Accelerometer Specifications

PART NUMBER:
KX127-1068
Rev. 2.0
05-Jun-2019

Embedded Registers

The KX127 has 78 embedded 8-bit registers that are accessible by the user. This section contains the addresses for all embedded registers and describes bit functions of each register. Table 11 provides a listing of the accessible 8-bit registers and their addresses.

Address	Register Name	R/W	Address	Register Name	R/W	Address	Register Name	R/W
00	MAN_ID	R	1C	CNTL3 ³	R/W	38-3B	Kionix Reserved ²	
01	PART_ID	R	1D	CNTL4 ³	R/W	3C	WUFTH ³	R/W
02	XHPL ¹	R	1E	CNTL5 ³	R/W	3D	BTSWUFTH ³	R/W
03	XHPH ¹	R	1F	ODCNTL ³	R/W	3E	BTSTH ³	R/W
04	YHPL ¹	R	20	INC1 ³	R/W	3F	BTSC ³	R/W
05	YHPH ¹	R	21	INC2 ³	R/W	40	WUFC ³	R/W
06	ZHPL ¹	R	22	INC3 ³	R/W	41	PED_WM_L ³	R/W
07	ZHPH ¹	R	23	INC4 ³	R/W	42	PED_WM_H ³	R/W
08	XOUTL	R	24	INC5 ³	R/W	43	PED_CNTL1 ³	R/W
09	XOUTH	R	25	INC6 ³	R/W	44	PED_CNTL2 ³	R/W
0A	YOUTL	R	26	INC7 ³	R/W	45	PED_CNTL3 ³	R/W
0B	YOUTH	R	27	TILT_TIMER ³	R/W	46	PED_CNTL4 ³	R/W
0C	ZOUTL	R	28	TDTRC ³	R/W	47	PED_CNTL5 ³	R/W
0D	ZOUTH	R	29	TDTC ³	R/W	48	PED_CNTL6 ³	R/W
0E	PED_STPL	R	2A	TTH ³	R/W	49	PED_CNTL7 ³	R/W
0F	PED_STPH	R	2B	TTL ³	R/W	4A	PED_CNTL8 ³	R/W
10	COTR	R	2C	FTD ³	R/W	4B	PED_CNTL9 ³	R/W
11	WHO_AM_I	R	2D	STD ³	R/W	4C	PED_CNTL10 ³	R/W
12	TSCP	R	2E	TLT ³	R/W	4D	SELF_TEST	W
13	TSPP	R	2F	TWS ³	R/W	4E - 59	Kionix Reserved ²	
14	INS1	R	30	FFTH ³	R/W	5A	BUF_CNTL1 ³	R/W
15	INS2	R	31	FFC ³	R/W	5B	BUF_CNTL2 ³	R/W
16	INS3	R	32	FFCNTL ³	R/W	5C	BUF_STATUS_1	R
17	STAT	R	33	Kionix Reserved ²		5D	BUF_STATUS_2	R
18	Kionix Reserved ²		34	TILT_ANGLE_LL ³	R/W	5E	BUF_CLEAR	W
19	INT_REL	R	35	TILT_ANGLE_HL ³	R/W	5F	BUF_READ	R
1A	CNTL1 ³	R/W	36	HYST_SET ³	R/W			
1B	CNTL2 ³	R/W	37	LP_CNTL ³	R/W			

Note¹: In addition of setting PC=1, HPE in CNTL4 needs to be set HIGH to enable high-pass data outputs

Note²: Reserved registers should not be written

Note³: When changing the contents of these registers, the PC1 bit in CNTL1 must first be set to "0".

Table 11: Register Map



± 2g / 4g / 8g Tri-axis Digital Accelerometer Specifications

PART NUMBER:
KX127-1068
Rev. 2.0
05-Jun-2019

Register Descriptions

Accelerometer Outputs

These registers contain up to 16-bits of valid acceleration data for each axis. However, the user may choose to read only the 8 MSB thus reading an effective 8-bit resolution. When BRES bit is set to 0 in BUF_CNTL2 register, the 8 MSB is the only data recorded in the buffer. The data is updated every user-defined ODR period, is protected from overwrite during each read, and can be converted from digital counts to acceleration (g) per Table 12. The register acceleration output binary data is represented in 2's complement format. For example, if N = 16 bits, then the Counts range is from -32768 to 32767, and if N = 8 bits, then the Counts range is from -128 to 127.

16-bit Register Data (2's complement)	Equivalent Counts in decimal	Range = ±2g	Range = ±4g	Range = ±8g
0111 1111 1111 1111	32767	+1.99994g	+3.99988g	+7.99976g
0111 1111 1111 1110	32766	+1.99988g	+3.99976g	+7.99951g
...
0000 0000 0000 0001	1	+0.00006g	+0.00012g	+0.00024g
0000 0000 0000 0000	0	0.00000g	0.00000g	0.00000g
1111 1111 1111 1111	-1	-0.00006g	-0.00012g	-0.00024g
...
1000 0000 0000 0001	-32767	-1.99994g	-3.99988g	-7.99976g
1000 0000 0000 0000	-32768	-2.00000g	-4.00000g	-8.00000g

8-bit Register Data (2's complement)	Equivalent Counts in decimal	Range = ±2g	Range = ±4g	Range = ±8g
0111 1111	127	+1.98438g	+3.96875g	+7.93750g
0111 1110	126	+1.96875g	+3.93750g	+7.87500g
...
0000 0001	1	+0.01563g	+0.03125g	+0.06250g
0000 0000	0	0.0000g	0.0000g	0.0000g
1111 1111	-1	-0.01563g	-0.03125g	-0.06250g
...
1000 0001	-127	-1.98438g	-3.96875g	-7.93750g
1000 0000	-128	-2.00000g	-4.00000g	-8.00000g

Table 12: Acceleration (g) Calculation



± 2g / 4g / 8g Tri-axis Digital Accelerometer Specifications

PART NUMBER:
KX127-1068
Rev. 2.0
05-Jun-2019

MAN_ID

A burst read (reading using the auto-increment) of 4 bytes starting at address 00, returns the manufacturing ID: "K" "i" "o" "n" in ASCII codes "0x4B" "0x69" "0x6F" "0x6E".

R	R	R	R	R	R	R	R
MANID7	MANID6	MANID5	MANID4	MANID3	MANID2	MANID1	MANID0
Bit7	Bit6	Bit5	Bit4	Bit3	Bit2	Bit1	Bit0
Address: 0x00							

PART_ID

A burst read (reading using the auto-increment) of 2 bytes starting at address 01, returns Who_Am_I value ("WAI") as the first byte (LSB) and a 2nd byte (MSB) that returns silicon specific ID.

R	R	R	R	R	R	R	R
PARTID7	PARTID6	PARTID5	PARTID4	PARTID3	PARTID2	PARTID1	PARTID0
Bit7	Bit6	Bit5	Bit4	Bit3	Bit2	Bit1	Bit0
Address: 0x01							

Note: A burst read (reading using the auto-increment) of 6 bytes starting at address 00, returns the MAN_ID followed by the 2 bytes of PART_ID

XHP_L

X-axis high-pass filter accelerometer output least significant byte. Data is updated at the ODR frequency determined by OWUF in CNTL3 and is available when HPE bit is set to 1 in CNTL4 register. 2's complement data format is used. Data is protected while reading using auto increment mode.

R	R	R	R	R	R	R	R
XHP7	XHP6	XHP5	XHP4	XHP3	XHP2	XHP1	XHP0
Bit7	Bit6	Bit5	Bit4	Bit3	Bit2	Bit1	Bit0
Address: 0x02							

XHP_H

X-axis high-pass filter accelerometer output most significant byte. Data is updated at the ODR frequency determined by OWUF in CNTL3 and is available when HPE bit is set to 1 in CNTL4 register. 2's complement data format is used. Data is protected while reading using auto increment mode.

R	R	R	R	R	R	R	R
XHP15	XHP14	XHP13	XHP12	XHP11	XHP10	XHP9	XHP8
Bit7	Bit6	Bit5	Bit4	Bit3	Bit2	Bit1	Bit0
Address: 0x03							



± 2g / 4g / 8g Tri-axis Digital Accelerometer Specifications

PART NUMBER:
KX127-1068
Rev. 2.0
05-Jun-2019

YHP_L

Y-axis high-pass filter accelerometer output least significant byte. Data is updated at the ODR frequency determined by OWUF in CNTL3 and is available when HPE bit is set to 1 in CNTL4 register. 2's complement data format is used. Data is protected while reading using auto increment mode.

R	R	R	R	R	R	R	R
YHP7	YHP6	YHP5	YHP4	YHP3	YHP2	YHP1	YHP0
Bit7	Bit6	Bit5	Bit4	Bit3	Bit2	Bit1	Bit0
Address: 0x04							

YHP_H

Y-axis high-pass filter accelerometer output most significant byte. Data is updated at the ODR frequency determined by OWUF in CNTL3 and is available when HPE bit is set to 1 in CNTL4 register. 2's complement data format is used. Data is protected while reading using auto increment mode.

R	R	R	R	R	R	R	R
YHP15	YHP14	YHP13	YHP12	YHP11	YHP10	YHP9	YHP8
Bit7	Bit6	Bit5	Bit4	Bit3	Bit2	Bit1	Bit0
Address: 0x05							

ZHP_L

Z-axis high-pass filter accelerometer output least significant byte. Data is updated at the ODR frequency determined by OWUF in CNTL3 and is available when HPE bit is set to 1 in CNTL4 register. 2's complement data format is used. Data is protected while reading using auto increment mode.

R	R	R	R	R	R	R	R
ZHP7	ZHP6	ZHP5	ZHP4	ZHP3	ZHP2	ZHP1	ZHP0
Bit7	Bit6	Bit5	Bit4	Bit3	Bit2	Bit1	Bit0
Address: 0x06							

ZHP_H

Z-axis high-pass filter accelerometer output most significant byte. Data is updated at the ODR frequency determined by OWUF in CNTL3 and is available when HPE bit is set to 1 in CNTL4 register. 2's complement data format is used. Data is protected while reading using auto increment mode.

R	R	R	R	R	R	R	R
ZHP15	ZHP14	ZHP13	ZHP12	ZHP11	ZHP10	ZHP9	ZHP8
Bit7	Bit6	Bit5	Bit4	Bit3	Bit2	Bit1	Bit0
Address: 0x07							



± 2g / 4g / 8g Tri-axis Digital Accelerometer Specifications

PART NUMBER:
KX127-1068
Rev. 2.0
05-Jun-2019

XOUT_L

X-axis accelerometer output least significant byte. Data is updated at the ODR frequency determined by OSA in ODCNTL register. 2's complement data format is used. Data is protected while reading using auto increment mode.

R	R	R	R	R	R	R	R
XOUT7	XOUT6	XOUT5	XOUT4	XOUT3	XOUT2	XOUT1	XOUT0
Bit7	Bit6	Bit5	Bit4	Bit3	Bit2	Bit1	Bit0
Address: 0x08							

XOUT_H

X-axis accelerometer output most significant byte. Data is updated at the ODR frequency determined by OSA in ODCNTL register. 2's complement data format is used. Data is protected while reading using auto increment mode.

R	R	R	R	R	R	R	R
XOUT15	XOUT14	XOUT13	XOUT12	XOUT11	XOUT10	XOUT9	XOUT8
Bit7	Bit6	Bit5	Bit4	Bit3	Bit2	Bit1	Bit0
Address: 0x09							

YOUT_L

Y-axis accelerometer output least significant byte. Data is updated at the ODR frequency determined by OSA in ODCNTL register. 2's complement data format is used. Data is protected while reading using auto increment mode.

R	R	R	R	R	R	R	R
YOUT7	YOUT6	YOUT5	YOUT4	YOUT3	YOUT2	YOUT1	YOUT0
Bit7	Bit6	Bit5	Bit4	Bit3	Bit2	Bit1	Bit0
Address: 0x0A							

YOUT_H

Y-axis accelerometer output most significant byte. Data is updated at the ODR frequency determined by OSA in ODCNTL register. 2's complement data format is used. Data is protected while reading using auto increment mode.

R	R	R	R	R	R	R	R
YOUT15	YOUT14	YOUT13	YOUT12	YOUT11	YOUT10	YOUT9	YOUT8
Bit7	Bit6	Bit5	Bit4	Bit3	Bit2	Bit1	Bit0
Address: 0x0B							



± 2g / 4g / 8g Tri-axis Digital Accelerometer Specifications

PART NUMBER:
KX127-1068
Rev. 2.0
05-Jun-2019

ZOUT_L

Z-axis accelerometer output least significant byte. Data is updated at the ODR frequency determined by OSA in ODCNTL register. 2's complement data format is used. Data is protected while reading using auto increment mode.

R	R	R	R	R	R	R	R
ZOUT7	ZOUT6	ZOUT5	ZOUT4	ZOUT3	ZOUT2	ZOUT1	ZOUT0
Bit7	Bit6	Bit5	Bit4	Bit3	Bit2	Bit1	Bit0
Address: 0x0C							

ZOUT_H

Z-axis accelerometer output most significant byte. Data is updated at the ODR frequency determined by OSA in ODCNTL register. 2's complement data format is used. Data is protected while reading using auto increment mode.

R	R	R	R	R	R	R	R
ZOUT15	ZOUT14	ZOUT13	ZOUT12	ZOUT11	ZOUT10	ZOUT9	ZOUT8
Bit7	Bit6	Bit5	Bit4	Bit3	Bit2	Bit1	Bit0
Address: 0x0D							

Not Recommended for New Designs



± 2g / 4g / 8g Tri-axis Digital Accelerometer Specifications

PART NUMBER:
KX127-1068
Rev. 2.0
05-Jun-2019

PED_STP_L and PED_STP_H

16-bit pedometer step counter register. The 16-bit counter value is cleared when PED_STP_H register is read. Note, these registers are read-protected. If a step occurs during a read of these registers, the new step will be added after the read completes.

R	R	R	R	R	R	R	R	PED_STP_L
STP7	STP6	STP5	STP4	STP3	STP2	STP1	STP0	
Bit7	Bit6	Bit5	Bit4	Bit3	Bit2	Bit1	Bit0	
								Address: 0x0E

R	R	R	R	R	R	R	R	PED_STP_H
STP15	STP14	STP13	STP12	STP11	STP10	STP9	STP8	
Bit7	Bit6	Bit5	Bit4	Bit3	Bit2	Bit1	Bit0	
								Address: 0x0F

COTR

The Command Test Response (COTR) register is used to verify proper integrated circuit functionality. The value of this register will change from a default value of 0x55 to 0xAA when COTC bit in CNTL2 register is set. After reading 0xAA from this register, the byte value returns to the default value of 0x55 and COTC bit in CNTL2 register is cleared.

R	R	R	R	R	R	R	R	
COTR7	COTR6	COTR5	COTR4	COTR3	COTR2	COTR1	COTR0	Reset Value
Bit7	Bit6	Bit5	Bit4	Bit3	Bit2	Bit1	Bit0	01010101
								Address: 0x10

WHO_AM_I

This register can be used for supplier recognition, as it can be factory written to a known byte value. WHO_AM_I is also the first byte (LSB) of the PART_ID. The default value is 0x3B.

R	R	R	R	R	R	R	R	
WAI7	WAI6	WAI5	WAI4	WAI3	WAI2	WAI1	WAI0	Reset Value
Bit7	Bit6	Bit5	Bit4	Bit3	Bit2	Bit1	Bit0	00111011
								Address: 0x11



± 2g / 4g / 8g Tri-axis Digital Accelerometer Specifications

PART NUMBER:
KX127-1068
Rev. 2.0
05-Jun-2019

Tilt Position Registers

These two registers report previous and current position data that is updated at the user-defined ODR frequency determined by OTP<1:0> in CNTL3. Data is protected during register read. Table 13 describes the reported position for each bit value.

TSCP

The Tilt Status Current Position (TSCP) register reports the current tilt position.

R	R	R	R	R	R	R	R	
0	0	LE	RI	DO	UP	FD	FU	Reset Value
Bit7	Bit6	Bit5	Bit4	Bit3	Bit2	Bit1	Bit0	00100000
								Address: 0x12

TSPP

The Tilt Status Previous Position (TSPP) register reports previous tilt position.

R	R	R	R	R	R	R	R	
0	0	LE	RI	DO	UP	FD	FU	Reset Value
Bit7	Bit6	Bit5	Bit4	Bit3	Bit2	Bit1	Bit0	00100000
								Address: 0x13

Bit	Description
LE	Left State (X-)
RI	Right State (X+)
DO	Down State (Y-)
UP	Up State (Y+)
FD	Face-Down State (Z-)
FU	Face-Up State (Z+)

Table 13: Tilt Position



± 2g / 4g / 8g Tri-axis Digital Accelerometer Specifications

PART NUMBER:
KX127-1068
Rev. 2.0
05-Jun-2019

Interrupt Source Registers

These three registers report interrupt state changes. This data is updated when a new interrupt event occurs and each application's result is latched until the interrupt release register is read.

INS1

The Interrupt Source 1 (INS1) register contains 2 step counter interrupts and contains the Tap/Double-Tap™ axis specific interrupts. Data is updated at the ODR settings determined by OTDT<2:0> in CNTL3.

R	R	R	R	R	R	R	R
STPOVI	STPWMI	TLE	TRI	TDO	TUP	TFD	TFU
Bit7	Bit6	Bit5	Bit4	Bit3	Bit2	Bit1	Bit0
							Address: 0x14

STPOVI – Step counter Overflow interrupt. This bit is cleared when the interrupt latch release register (INT_REL) is read

STPWMI – Step counter Watermark interrupt. This bit is cleared when either the PED_STPL or PED_STPH step count registers is read.

Bit	Description
TLE	X Negative (X-) Reported
TRI	X Positive (X+) Reported
TDO	Y Negative (Y-) Reported
TUP	Y Positive (Y+) Reported
TFD	Z Negative (Z-) Reported
TFU	Z Positive (Z+) Reported

Table 14: Directional-Tap™ Reporting

INS2

This register tells which function caused an interrupt.

R	R	R	R	R	R	R	R
FFS	BFI	WMI	DRDY	TDTS1	TDTS0	STPINCI	TPS
Bit7	Bit6	Bit5	Bit4	Bit3	Bit2	Bit1	Bit0
							Address: 0x15

FFS – Free fall. This bit is cleared when the interrupt latch release register (INT_REL) is read.

FFS = 0 – No Free fall

FFS = 1 – Free fall has activated the interrupt



± 2g / 4g / 8g Tri-axis Digital Accelerometer Specifications

PART NUMBER:
KX127-1068
Rev. 2.0
05-Jun-2019

BFI – Buffer Full Interrupt. Automatically cleared when at least one sample is read from the buffer or following the write to BUF_CLEAR register.

BFI = 0 – Buffer is not full

BFI = 1 – Buffer is full

WMI – The Watermark Interrupt bit is set to 1 when FIFO has filled up to the value stored in the SMP_TH <9:0> bits. when in FIFO, FILO, or Stream mode. Not used in Trigger mode. This bit is automatically cleared when FIFO is read and the SMP_LEV<10:0> returns to a value below the value stored in the SMP_TH <9:0> bits, or following the write to BUF_CLEAR register.

WMI = 0 – Buffer watermark has not been exceeded

WMI = 1 – Buffer watermark has been exceeded

DRDY – The Data Ready bit indicates that new acceleration data (0x08 to 0x0D) is available. This bit is cleared when acceleration data is read or the interrupt latch release register (INT_REL) is read.

DRDY = 0 - new acceleration data not available

DRDY = 1 - new acceleration data available

TDTS1, TDTS0 – The Tap/Double-Tap™ Status bits indicate whether a tap event has occurred and what kind. The status bits are cleared when interrupt release register INT_REL is read.

TDTS1	TDTS0	Event
0	0	No Tap
0	1	Single Tap
1	0	Double Tap
1	1	undefined

STPINCI – The Step counter Increment Interrupt bit is cleared when the interrupt latch release register (INT_REL) is read.

STPINCI = 1 – Step counter value has incremented

STPINCI = 0 – No step detected

TPS – The Tilt Position Status bit is cleared when the interrupt release register INT_REL is read.

TPS = 0 – Position has not changed

TPS = 1 – Position has changed



± 2g / 4g / 8g Tri-axis Digital Accelerometer Specifications

PART NUMBER:
KX127-1068
Rev. 2.0
05-Jun-2019

INS3

The Interrupt Source 3 (INS3) register reports the interrupt status of the Wake-Up and Back-to-Sleep functions, as well as the axis and direction of the Wake-Up detected motion.

R	R	R	R	R	R	R	R
WUFS	BTS	XNWU	XPWU	YNWU	YPWU	ZNWU	ZPWU
Bit7	Bit6	Bit5	Bit4	Bit3	Bit2	Bit1	Bit0
Address: 0x16							

WUFS – The Wake-Up Function Status interrupt bit is cleared when the interrupt latch release register (INT_REL) is read.

WUFS = 1 – Motion is above the wake-up threshold WUFTH<10:0>

WUFS = 0 – Motion is below the wake-up threshold WUFTH<10:0>

BTS – Back-to-Sleep interrupt. This bit is cleared when the interrupt latch release register (INT_REL) is read.

BTS = 1 – Motion is below the back-to-sleep threshold BTSTH <10:0>

BTS = 0 – Motion is above the back-to-sleep threshold BTSTH <10:0>

Bit	Description
XNWU	X Negative (X-) Reported
XPWU	X Positive (X+) Reported
YNWU	Y Negative (Y-) Reported
YPWU	Y Positive (Y+) Reported
ZNWU	Z Negative (Z-) Reported
ZPWU	Z Positive (Z+) Reported

Table 15: Motion Detection Reporting



± 2g / 4g / 8g Tri-axis Digital Accelerometer Specifications

PART NUMBER:
KX127-1068
Rev. 2.0
05-Jun-2019

STAT

The Status Register reports the status of whether the interrupt is present.

R	R	R	R	R	R	R	R
0	0	0	INT	0	0	0	WAKE
Bit7	Bit6	Bit5	Bit4	Bit3	Bit2	Bit1	Bit0
Address: 0x17							

INT – The INT bit reports the combined (OR) interrupt information of all features. If BFI and WMI bits in INS2 register and STPWMI in INS1 register are 0, the INT bit is set to 0 when INT_REL register is read. If WMI or BFI bit in INS2 register or STPWMI bit in INS1 register are 1, INT bit remains at 1 until these bits are cleared by either FIFO/FILO buffer read in case of WMI/BFI bits or when either the low byte of the step counter (PED_STP_L) or the high byte of the step counter (PED_STP_H) is read in case of STPWMI bit.

INT = 0 – interrupt event has not occurred

INT = 1 – interrupt event has occurred

WAKE – The WAKE bit reports the current state of the KX127

WAKE = 0 – Back-To-Sleep state

WAKE = 1 – Wake state

Note: Wake is the default state at power-up, shown in STAT register. For wake engine only operation, set MAN_SLEEP bit to 1 in CNTL5 register to put KX127 in sleep state for the first time.



± 2g / 4g / 8g Tri-axis Digital Accelerometer Specifications

PART NUMBER:
KX127-1068
Rev. 2.0
05-Jun-2019

INT_REL

Interrupt Release (INT_REL) register: Latched interrupt source information reported in INS1, INS2, and INS3 registers is cleared and physical interrupt latched pin is changed to its inactive state when this register is read. However, WMI, BFI bits in INS2 register and STPWMI bit in INS1 register are not cleared by this command. Furthermore, INT bit in STAT will not be cleared by reading this register if WMI or BFI bits in INS2 register or STPWMI bit in INS1 register are set to 1. Read value is dummy.

R	R	R	R	R	R	R	R
0	0	0	0	0	0	0	0
Bit7	Bit6	Bit5	Bit4	Bit3	Bit2	Bit1	Bit0
Address: 0x19							

CNTL1

Control register 1. Read/write control register that controls the main feature set.

R/W	R/W	R/W	R/W	R/W	R/W	R/W	R/W	Reset Value
PC1	RES	DRDYE	GSEL1	GSEL0	TDTE	PDE	TPE	00000000
Bit7	Bit6	Bit5	Bit4	Bit3	Bit2	Bit1	Bit0	00000000
Address: 0x1A								

PC1 – The PC1 bit controls the operating mode of the KX127.

PC1 = 0 – Standby mode

PC1 = 1 – operating mode (Low Power or High Resolution)

RES – The RES bit determines the performance mode of the KX127. The noise varies with ODR, RES and different LP_CNTL settings possibly reducing the effective resolution. Note that to change the value of this bit, the PC1 bit must first be set to “0”.

RES = 0 – Low Power mode (higher noise, lower current, 16-bit output data)

RES = 1 – High Resolution mode (lower noise, higher current, 16-bit output data)

DRDYE – The Data Ready Enable bit enables the reporting of the availability of new acceleration data as an interrupt. Note that to change the value of this bit, the PC1 bit must first be set to “0”.

DRDYE = 0 – availability of new acceleration data is not reflected as an interrupt

DRDYE = 1 – availability of new acceleration data is reflected as an interrupt



± 2g / 4g / 8g Tri-axis Digital Accelerometer Specifications

PART NUMBER:
KX127-1068
Rev. 2.0
05-Jun-2019

GSEL1, GSEL0 – The G-Select bits allow to select the acceleration range of the accelerometer outputs per Table 16. Note that to change the value of this bit, the PC1 bit must first be set to “0”.

GSEL1	GSEL0	Range
0	0	±2g
0	1	±4g
1	X	±8g

Table 16: Selected Acceleration Range

TDTE – The Tap/Double-Tap™ Enable bit enables the Directional-Tap™ function that will detect single and double tap events. Note that to change the value of this bit, the PC1 bit must first be set to “0”.

TDTE = 0 – Tap/Double-Tap™ disabled
 TDTE = 1 – Tap/Double-Tap™ enabled

PDE – The Pedometer Enable bit enables the pedometer (step-counter) engine. Note that to change the value of this bit, the PC1 bit must first be set to “0”.

PDE = 0 – Pedometer engine disabled
 PDE = 1 – Pedometer engine enabled

TPE – The Tilt Position Enable bit enables the Tilt Position function that will detect changes in device orientation. Note that to change the value of this bit, the PC1 bit must first be set to “0”.

TPE = 0 – Tilt Position function disabled
 TPE = 1 – Tilt Position function enabled

CNTL2

The Control 2 (CNTL2) register primarily controls tilt position state enabling. If a tilt direction bit’s state is set to one (1), a transition into the corresponding orientation state will generate an interrupt. If it is set to zero (0), a transition into the corresponding orientation state will not generate an interrupt. Note that to properly change the value of this register, the PC1 bit in CNTL1 must first be set to “0”.

R/W	R/W	R/W	R/W	R/W	R/W	R/W	R/W	Reset Value
SRST	COTC	LEM	RIM	DOM	UPM	FDM	FUM	00111111
Bit7	Bit6	Bit5	Bit4	Bit3	Bit2	Bit1	Bit0	
Address: 0x1B								



± 2g / 4g / 8g Tri-axis Digital Accelerometer Specifications

PART NUMBER:

KX127-1068

Rev. 2.0

05-Jun-2019

SRST – The Software Reset bit initiates software reset, which performs the RAM reboot routine. This bit will remain 1 until the RAM reboot routine is finished. Please refer to Technical Note [TN021 Power-On Procedure](#) for more information on software reset.

SRST = 0 – no action

SRST = 1 – start POR / RAM reboot routine

Note for I²C Communication: Setting SRST = 1 will NOT result in an ACK, since the part immediately enters the RAM reboot routine. NACK may be used to confirm this command.

COTC – The Command Test Control bit is used to verify proper ASIC functionality.

COTC = 0 – no action

COTC = 1 – sets COTR register to 0xAA. When COTR register is then read, sets COTC bit to 0 and sets COTR register to 0x55.

LEM, RIM, DOM, UPM, FDM, FUM – these bits control the tilt axis mask. Per Table 17, if a direction's bit is set to one (1), tilt in that direction will generate an interrupt. If it is set to zero (0), tilt in that direction will not generate an interrupt.

Bit	Description
LEM	Left state enable (X-)
RIM	Right state enable (X+)
DOM	Down state enable (Y-)
UPM	Up state enable (Y+)
FDM	Face-Down state enable (Z-)
FUM	Face-Up state enable (Z+)

Table 17: Tilt Direction Axis Mask



± 2g / 4g / 8g Tri-axis Digital Accelerometer Specifications

PART NUMBER:
KX127-1068
Rev. 2.0
05-Jun-2019

CNTL3

The Control 3 (CNTL3) register sets the output data rates for Tilt, Directional-Tap™, and the Motion Wake-Up digital engines. The output data rate set in this register and the averaging filter control settings set in LP_CNTL register, will influence overall performance of the digital engines and the power consumption of the accelerometer. Note that to properly change the value of this register, the PC1 bit in CNTL1 register must first be set to “0”.

R/W	R/W	R/W	R/W	R/W	R/W	R/W	R/W	Reset Value
OTP1	OTP0	OTDT2	OTDT1	OTDT0	OWUF2	OWUF1	OWUF0	10011000
Bit7	Bit6	Bit5	Bit4	Bit3	Bit2	Bit1	Bit0	
Address: 0x1C								

OTP1, OTP0 – The ODR Tilt bits set the output data rate for the Tilt Position function per Table 18. The default Tilt Position ODR is 12.5Hz.

OTP1	OTP0	Output Data Rate
0	0	1.563Hz
0	1	6.25Hz
1	0	12.5Hz
1	1	50Hz

Table 18: Tilt Position Function Output Data Rate

OTDT2, OTDT1, OTDT0 – The ODR Tap/Double-Tap™ bits set the output data rate for the Directional-Tap™ function per Table 19. The default Directional-Tap™ ODR is 400Hz.

OTDT2	OTDT1	OTDT0	Output Data Rate
0	0	0	50Hz
0	0	1	100Hz
0	1	0	200Hz
0	1	1	400Hz
1	0	0	12.5Hz
1	0	1	25Hz
1	1	0	800Hz
1	1	1	1600Hz

Table 19: Directional-Tap™ Function Output Data Rate



± 2g / 4g / 8g Tri-axis Digital Accelerometer Specifications

PART NUMBER:
KX127-1068
Rev. 2.0
05-Jun-2019

OWUF2, OWUF1, OWUF0 – The ODR Wake-Up Function bits set the output data rate for the general motion detection function and the high-pass filtered outputs per Table 20.

The default Motion Wake-Up ODR is 0.781Hz.

Note: OWUF<2:0> setting needs to be less than or equal to OSA<3:0> to avoid irregular resulting acceleration ODR's.

OWUF2	OWUF1	OWUF0	Output Data Rate
0	0	0	0.781Hz
0	0	1	1.563Hz
0	1	0	3.125Hz
0	1	1	6.250Hz
1	0	0	12.5Hz
1	0	1	25Hz
1	1	0	50Hz
1	1	1	100Hz

Table 20: Motion Wake-Up Function Output Data Rate

CNTL4

The Control 4 (CNTL4) register 4 provides more feature set control. Note that to properly change the value of this register, the PC1 bit in CNTL1 must first be set to "0".

R/W	R/W	R/W	R/W	R/W	R/W	R/W	R/W	Reset Value
C_MODE	TH_MODE	WUFE	BTSE	HPE	OBTS2	OBTS1	OBTS0	01000000
Bit7	Bit6	Bit5	Bit4	Bit3	Bit2	Bit1	Bit0	
Address: 0x1D								

C_MODE – The Counter Mode bit defines debounce counter operation

C_MODE = 0 – debounce counter is in clear mode

C_MODE = 1 – debounce counter is in decrement mode

TH_MODE – The Threshold Mode bit defines the type of the wake / back-to-sleep threshold

TH_MODE = 0 – absolute threshold

TH_MODE = 1 – relative threshold

WUFE – The Wake-Up Function Enable bit enables the Wake-up engine

WUFE = 0 – Wake-up engine is disabled

WUFE = 1 – Wake-up engine is enabled



± 2g / 4g / 8g Tri-axis Digital Accelerometer Specifications

PART NUMBER:
KX127-1068
Rev. 2.0
05-Jun-2019

BTSE – The Back-to-Sleep Enable bit enables the Back-to-Sleep engine
BTSE = 0 – disabled
BTSE = 1 – enable

HPE – The High-Pass Enable bit enables the High-pass outputs XHP, YHP, ZHP
HPE = 0 – high-pass outputs disabled
HPE = 1 – high-pass outputs enabled

OBTS2, OBTS1, OBTS0 – The ODR Back-To-Sleep bits set the output data rate (per Table 21) at which the back-to-sleep (motion detection) performs its function during wake state.

The default Back-to-sleep ODR is 0.781Hz.

Note: OBTS<2:0> setting needs to be less than or equal to OSA<3:0> to avoid irregular resulting acceleration ODR's.

OBTS2	OBTS1	OBTS0	Output Data Rate
0	0	0	0.781Hz
0	0	1	1.563Hz
0	1	0	3.125Hz
0	1	1	6.250Hz
1	0	0	12.5Hz
1	0	1	25Hz
1	1	0	50Hz
1	1	1	100Hz

Table 21: Motion Back-to-Sleep Function Output Data Rate



± 2g / 4g / 8g Tri-axis Digital Accelerometer Specifications

PART NUMBER:
KX127-1068
Rev. 2.0
05-Jun-2019

CNTL5

The Control 5 (CNTL5) register provides additional controls for wake-sleep engine. Note that to properly change the value of this register, the PC1 bit in CNTL1 must first be set to "0".

R/W	R/W	R/W	R/W	R/W	R/W	R/W	R/W	
0	0	0	0	0	0	MAN_WAKE	MAN_SLEEP	Reset Value
Bit7	Bit6	Bit5	Bit4	Bit3	Bit2	Bit1	Bit0	0000001
Address: 0x1E								

MAN_WAKE – The manual wake overwrite bit

MAN_WAKE = 0 – default

MAN_WAKE = 1 – forces wake state (bit is self-cleared)

MAN_SLEEP – The manual sleep overwrite bit

MAN_SLEEP = 0 – default

MAN_SLEEP = 1 – forces sleep state (bit is self-cleared)

Notes:

1. For having both WUF & BTS engine which has a wake state, if there is a wake interrupt, no additional wake interrupt is received until part is put back to sleep manually (using man_sleep bit) or using the BTS interrupt.
2. Wake is the default state at power-up, shown in STAT register. For wake engine only operation, set MAN_SLEEP bit to 1 in CNTL5 register to put KX127 in sleep state for the first time.

	± 2g / 4g / 8g Tri-axis Digital Accelerometer Specifications	PART NUMBER:
		KX127-1068
		Rev. 2.0
		05-Jun-2019

ODCNTL

The ODR Control (ODCNTL) register is responsible for configuring Output Data Rate (ODR) and low-pass filter settings. Note that to properly change the value of this register, the PC1 bit in CNTL1 register must first be set to “0”.

R/W	R/W	R/W	R/W	R/W	R/W	R/W	R/W	
IIR_BYPASS	LPRO	0	0	OSA3	OSA2	OSA1	OSA0	Reset Value
Bit7	Bit6	Bit5	Bit4	Bit3	Bit2	Bit1	Bit0	00000010
Address: 0x1F								

IIR_BYPASS filter bypass mode

IIR_BYPASS = 0 – filtering applied (default)

IIR_BYPASS = 1 – filter bypassed. This setting may reduce the resolution of the output data.

LPRO low-pass filter roll off control

LPRO = 0 – filter corner frequency set to ODR/9 (default)

LPRO = 1 – filter corner frequency set to ODR/2

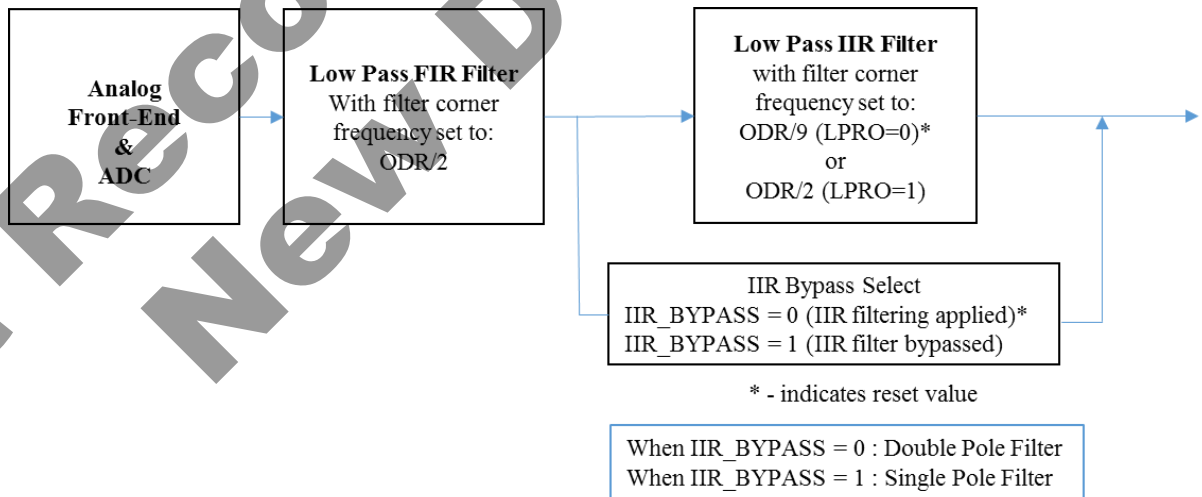

Figure 10: Low-Pass Filter Design and Control Circuitry



± 2g / 4g / 8g Tri-axis Digital Accelerometer Specifications

PART NUMBER:
KX127-1068
Rev. 2.0
05-Jun-2019

OSA3, OSA2, OSA1, OSA0 – The OSA <3:0> bits set the acceleration output data rate (ODR). The default ODR is 50Hz.

OSA3	OSA2	OSA1	OSA0	Output Data Rate
0	0	0	0	12.5Hz*
0	0	0	1	25Hz*
0	0	1	0	50Hz*
0	0	1	1	100Hz*
0	1	0	0	200Hz*
0	1	0	1	400Hz*
0	1	1	0	800Hz
0	1	1	1	1600Hz
1	0	0	0	0.781Hz*
1	0	0	1	1.563Hz*
1	0	1	0	3.125Hz*
1	0	1	1	6.25Hz*
1	1	0	0	3200Hz**
1	1	0	1	6400Hz**
1	1	1	0	12800Hz**
1	1	1	1	25600Hz**

Table 22: Accelerometer Output Data Rates (ODR)

* Low Power mode available, all other data rates will default to High Resolution mode

Not Recommended for New Designs



± 2g / 4g / 8g Tri-axis Digital Accelerometer Specifications

PART NUMBER:
KX127-1068
Rev. 2.0
05-Jun-2019

INC1

The Interrupt Control 1 (INC1) register controls the settings for the physical interrupt pin INT1, the Self-test function, and 3-wire SPI interface. Note that to properly change the value of this register, the PC1 bit in CNTL1 register must first be set to “0”.

R/W	R/W	R/W	R/W	R/W	R/W	R/W	R/W	
PW11	PW10	IEN1	IEA1	IEL1	Reserved	STPOL	SPI3E	Reset Value
Bit7	Bit6	Bit5	Bit4	Bit3	Bit2	Bit1	Bit0	00010000
Address: 0x20								

PW1<1:0> – Pulse interrupt 1 width configuration.

- 00 = 50 μ sec (10 μ sec if OSA > 1600Hz)
- 01 = 1 * OSA period
- 10 = 2 * OSA periods
- 11 = 4 * OSA periods

When PW1 > 0, Interrupt source auto-clearing (ACLR1=1) should be set to keep consistency between the internal status and the physical interrupt.

IEN1 enables/disables the physical interrupt pin INT1

- IEN1 = 0 – physical interrupt pin is disabled
- IEN1 = 1 – physical interrupt pin is enabled

IEA1 Interrupt active level control for interrupt pin INT1

- IEA1 = 0 – polarity of the physical interrupt pin is active LOW
- IEA1 = 1 – polarity of the physical interrupt pin is active HIGH

IEL1 Interrupt latch control for physical interrupt pin INT1

- IEL1 = 0 – the physical interrupt pin latches until it is cleared by reading INT_REL. (excludes BFI, WMI, STPWMI).
- IEL1 = 1 – the physical interrupt pin will transmit one pulse configurable by PWSEL1

STPOL sets the polarity of Self-test.

- STPOL = 0 – Negative
- STPOL = 1 – Positive

SPI3E sets the 3-wire SPI interface (set to 0 when I²C communication is used)

- SPI3E = 0 – disabled
- SPI3E = 1 – enabled



± 2g / 4g / 8g Tri-axis Digital Accelerometer Specifications

PART NUMBER:
KX127-1068
Rev. 2.0
05-Jun-2019

INC2

The Interrupt Control 2 (INC2) register defines interrupt behavior for the Wake-Up Function (WUF) and Back-to-Sleep (BTS) engines. Note that to properly change the value of this register, the PC1 bit in CNTL1 must first be set to “0”.

R/W	R/W	R/W	R/W	R/W	R/W	R/W	R/W	Reset Value
Reserved	AOI	XNWUE	XPWUE	YNWUE	YPWUE	ZNWUE	ZPWUE	00111111
Bit7	Bit6	Bit5	Bit4	Bit3	Bit2	Bit1	Bit0	
Address: 0x21								

Reserved – this bit is reserved, and its value should not be changed.

AOI – AND-OR configuration on motion detection

AOI = 0 – OR combination between selected directions

AOI = 1 – AND combination between selected axes

Ex. If all directions are enabled,

Active state in OR configuration = (XN || XP || YN || YP || ZN || ZP)

Active state in AND configuration = (XN || XP) && (YN || YP) && (ZN || ZP)

XNWUE – X Negative (X-) mask for WUF and BTS

XNWUE = 0 - WUF/BTS ignores (X-) axis

XNWUE = 1 - enable the (X-) interrupt source

XPWUE – X Positive (X+) mask for WUF and BTS

XPWUE = 0 - WUF/BTS ignores (X+) axis

XPWUE = 1 - enable the (X+) interrupt source

YNWUE – Y Negative (Y-) mask for WUF and BTS

YNWUE = 0 - WUF/BTS ignores (Y-) axis

YNWUE = 1 - enable the (Y-) interrupt source

YPWUE – Y Positive (Y+) mask for WUF and BTS

YPWUE = 0 - WUF/BTS ignores (Y+) axis

YPWUE = 1 - enable the (Y+) interrupt source

ZNWUE – Z negative (Z-) mask for WUF and BTS

ZNWUE = 0 - WUF/BTS ignores (Z-) axis

ZNWUE = 1 - enable the (Z-) interrupt source

ZPWUE – Z positive (Z+) mask for WUF and BTS

ZPWUE = 0 - WUF/BTS ignores (Z+) axis

ZPWUE = 1 - enable the (Z+) interrupt source



± 2g / 4g / 8g Tri-axis Digital Accelerometer Specifications

PART NUMBER:
KX127-1068
Rev. 2.0
05-Jun-2019

INC3

The Interrupt Control 3 (INC3) register controls which axis and direction of Tap/Double-Tap™ can cause an interrupt. If a direction's bit is set to one (1), a single or double tap in that direction will generate an interrupt. If it is set to zero (0), a single or double tap in that direction will not generate an interrupt. Note that to properly change the value of this register, the PC1 bit in CNTL1 must first be set to "0".

R/W	R/W	R/W	R/W	R/W	R/W	R/W	R/W	
0	TMEN	TLEM	TRIM	TDOM	TUPM	TFDM	TFUM	Reset Value
Bit7	Bit6	Bit5	Bit4	Bit3	Bit2	Bit1	Bit0	00111111
								Address: 0x22

TMEN – enables/disables alternate tap masking scheme
 TMEN = 0 – alternate tap masking scheme disabled
 TMEN = 1 – alternate tap masking scheme enabled

TLEM – Tap Left (X-) state mask
 TLEM = 0 – Tap engine ignores (X-) axis
 TLEM = 1 – Enable the (X-) interrupt source

TRIM – Tap Right (X+) state mask
 TRIM = 0 – Tap engine ignores (X+) axis
 TRIM = 1 – Enable the (X+) interrupt source

TDOM – Tap Down (Y-) state mask
 TDOM = 0 – Tap engine ignores (Y-) axis
 TDOM = 1 – Enable the (Y-) interrupt source

TUPM – Tap Up (Y+) state mask
 TUPM = 0 – Tap engine ignores (Y+) axis
 TUPM = 1 – Enable the (Y+) interrupt source

TFDM – Tap Face Down (Z-) state mask
 TFDM = 0 – Tap engine ignores (Z-) axis
 TFDM = 1 – Enable the (Z-) interrupt source

TFUM – Tap Face Up (Z+) state mask
 TFUM = 0 – Tap engine ignores (Z+) axis
 TFUM = 1 – Enable the (Z+) interrupt source



± 2g / 4g / 8g Tri-axis Digital Accelerometer Specifications

PART NUMBER:
KX127-1068
Rev. 2.0
05-Jun-2019

INC4

The Interrupt Control 4 (INC4) register controls routing of an interrupt reporting to physical interrupt pin INT1. Note that to properly change the value of this register, the PC1 bit in CNTL1 must first be set to "0".

R/W	R/W	R/W	R/W	R/W	R/W	R/W	R/W	Reset Value
FFI1	BFI1	WMI1	DRDY11	BTSI1	TDTI1	WUF11	TPI1	00000000
Bit7	Bit6	Bit5	Bit4	Bit3	Bit2	Bit1	Bit0	

Address: 0x23

FFI1 – Free fall interrupt reported on physical interrupt pin INT1

FFI1 = 0 – disable

FFI1 = 1 – enable

BFI1 – Buffer full interrupt reported on physical interrupt pin INT1

BFI = 0 – disable

BFI = 1 – enable

WMI1 - Watermark interrupt reported on physical interrupt pin INT1

WMI1 = 0 – disable

WMI1 = 1 – enable

Note: WMI, BFI, and STPWMI are level triggered interrupt source. If the valid condition persists, and the interrupt stays enabled, the interrupt will block any further interrupts from other sources from triggering the INT1 pin. In order to let other interrupt sources through, WMI/BFI/STPWMI needs to be cleared once detected.

DRDY11 – Data ready interrupt reported on physical interrupt pin INT1

DRDY11 = 0 – disable

DRDY11 = 1 – enable

BTSI1 – Back-to-Sleep interrupt reported on physical interrupt pin INT1

BTSI1 = 0 – disable

BTSI1 = 1 – enable

TDTI1 - Tap/Double Tap interrupt reported on physical interrupt pin INT1

TDTI1 = 0 – disable

TDTI1 = 1 – enable

WUF11 – Wake-Up (motion detect) interrupt reported on physical interrupt pin INT1

WUF11 = 0 – disable

WUF11 = 1 – enable

TPI1 – Tilt position interrupt reported on physical interrupt pin INT1

TPI1 = 0 – disable

TPI1 = 1 – enable



± 2g / 4g / 8g Tri-axis Digital Accelerometer Specifications

PART NUMBER:
KX127-1068
Rev. 2.0
05-Jun-2019

INC5

The Interrupt Control 5 (INC5) register controls the settings for the physical interrupt pin INT2. Note that to properly change the value of this register, the PC1 bit in CNTL1 must first be set to "0".

R/W	R/W	R/W	R/W	R/W	R/W	R/W	R/W	Reset Value
PW21	PW20	IEN2	IEA2	IEL2	0	ACLR2	ACLR1	00010000
Bit7	Bit6	Bit5	Bit4	Bit3	Bit2	Bit1	Bit0	
Address: 0x24								

PW2<1:0> – Pulse interrupt 2 width configuration

00 = 50 μ sec (10 μ sec if OSA > 1600Hz)

01 = 1 * OSA period

10 = 2 * OSA periods

11 = 4 * OSA periods

When PW2 > 0, Interrupt source auto-clearing (ACLR2=1) is strongly recommended to keep consistency between the internal status and the physical interrupt.

IEN2 enables/disables the physical interrupt pin INT2

IEN2 = 0 – physical interrupt pin is disabled

IEN2 = 1 – physical interrupt pin is enabled

IEA2 Interrupt active level control for interrupt pin INT2

IEA2 = 0 – polarity of the physical interrupt pin is active LOW

IEA2 = 1 – polarity of the physical interrupt pin is active HIGH

IEL2 Interrupt latch control for interrupt pin INT2

IEL2 = 0 – the physical interrupt pin latches until it is cleared by reading INT_REL. (excludes BFI, WMI, STPWMI).

IEL2 = 1 – the physical interrupt pin will transmit one pulse configurable by PW2

ACLR2 – Latched interrupt source information(INS1-INS3) is cleared and physical interrupt-2 latched pin is changed to its inactive state at pulse interrupt-2 trailing edge. Note: WMI, BFI, and STPWMI are not auto-cleared by a pulse interrupt trailing edge.

ACLR2 = 0 – disable

ACLR2 = 1 – enable

ACLR1 – Latched interrupt source information(INS1-INS3) is cleared and physical interrupt-1 latched pin is changed to its inactive state at pulse interrupt-1 trailing edge. Note: WMI, BFI, and STPWMI are not auto-cleared by a pulse interrupt trailing edge.

ACLR1 = 0 – disable

ACLR1 = 1 – enable



± 2g / 4g / 8g Tri-axis Digital Accelerometer Specifications

PART NUMBER:
KX127-1068
Rev. 2.0
05-Jun-2019

INC6

The Interrupt Control 6 (INC6) register controls routing of interrupt reporting to physical interrupt pin INT2. Note that to properly change the value of this register, the PC1 bit in CNTL1 must first be set to "0".

R/W	R/W	R/W	R/W	R/W	R/W	R/W	R/W	Reset Value
FFI2	BFI2	WMI2	DRDYI2	BTSI2	TDTI2	WUFI2	TPI2	00000000
Bit7	Bit6	Bit5	Bit4	Bit3	Bit2	Bit1	Bit0	
Address: 0x25								

FFI2 – Free fall interrupt reported on physical interrupt pin INT2

FFI2 = 0 – disable

FFI2 = 1 – enable

BFI2 – Buffer full interrupt reported on physical interrupt pin INT2

BF2 = 0 – disable

BF2 = 1 – enable

WMI2 – Watermark interrupt reported on physical interrupt pin INT2

WMI2 = 0 – disable

WMI2 = 1 – enable

Note: WMI, BFI, and STPWMI are level triggered interrupt source. If the valid condition persists, and the interrupt stays enabled, the interrupt will block any further interrupts from other sources from triggering the INT2 pin. In order to let other interrupt sources through, WMI/BFI/STPWMI needs to be cleared once detected.

DRDYI2 – Data ready interrupt reported on physical interrupt pin INT2

DRDYI2 = 0 – disable

DRDYI2 = 1 – enable

BTSI2 – Back-to-Sleep interrupt reported on physical interrupt pin INT2

BTSI2 = 0 – disable

BTSI2 = 1 – enable

TDTI2 – Tap/Double Tap interrupt reported on physical interrupt pin INT2

TDTI2 = 0 – disable

TDTI2 = 1 – enable

WUFI2 – Wake-Up (motion detect) interrupt reported on physical interrupt pin INT2

WUFI2 = 0 – disable

WUFI2 = 1 – enable

TPI2 – Tilt position interrupt reported on physical interrupt pin INT2

TPI2 = 0 – disable

TPI2 = 1 – enable



± 2g / 4g / 8g Tri-axis Digital Accelerometer Specifications

PART NUMBER:
KX127-1068
Rev. 2.0
05-Jun-2019

INC7

The Interrupt Control 7 (INC7) register controls the pedometer (step counter) engine. Note that to properly change the value of this register, the PC1 bit in CNTL1 must first be set to "0".

R/W	R/W	R/W	R/W	R/W	R/W	R/W	R/W	
0	STPOVI2	STPWMI2	STPINCI2	0	STPOVI1	STPWMI1	STPINCI1	Reset Value
Bit7	Bit6	Bit5	Bit4	Bit3	Bit2	Bit1	Bit0	00000000
Address: 0x26								

Please note, that the STPWMI is a level triggered interrupt source (same as BFI, WMI). Any mechanism to clear the INS register bits will fail as long as the condition persists. If the condition persists and the STPWMI interrupt stays enabled, the level triggered interrupt will block any further interrupts from other sources from triggering the pin. In order to let other interrupt sources through, STPWMI needs to be set LOW once detected. STPINCI and STPOVI are momentary events that do not persist.

STPOVI2 – Step counter overflow interrupt reported on physical interrupt pin INT2
 STPOVI2 = 0 – disable
 STPOVI2 = 1 – enable

STPWMI2 – Step counter watermark interrupt reported on physical interrupt pin INT2
 STPWMI2 = 0 – disable
 STPWMI2 = 1 – enable

STPINCI2 – Step counter increment interrupt reported on physical interrupt pin INT2
 STPINCI2 = 0 – disable
 STPINCI2 = 1 – enable

STPOVI1 – Step counter overflow interrupt reported on physical interrupt pin INT1
 STPOVI1 = 0 – disable
 STPOVI1 = 1 – enable

STPWMI1 – Step counter watermark interrupt reported on physical interrupt pin INT1
 STPWMI1 = 0 – disable
 STPWMI1 = 1 – enable

STPINCI1 – Step counter increment interrupt reported on physical interrupt pin INT1
 STPINCI1 = 0 – disable
 STPINCI1 = 1 – enable



± 2g / 4g / 8g Tri-axis Digital Accelerometer Specifications

PART NUMBER:
KX127-1068
Rev. 2.0
05-Jun-2019

TILT_TIMER

This register is the initial count register for the tilt position state timer (0 to 255 counts). Every count is calculated as 1/ODR delay period, where the ODR is user-defined per Table 18. Note that to properly change the value of this register, the PC1 bit in CNTL1 must first be set to "0".

R/W	R/W	R/W	R/W	R/W	R/W	R/W	R/W	
TSC7	TSC6	TSC5	TSC4	TSC3	TSC2	TSC1	TSC0	Reset Value
Bit7	Bit6	Bit5	Bit4	Bit3	Bit2	Bit1	Bit0	00000000
								Address: 0x27

TDTRC

The Tap/Double-Tap™ Report Control (TDTRC) register is responsible for enabling/disabling reporting of Tap/Double-Tap™ events. Note that to properly change the value of this register, the PC1 bit in CNTL1 register must first be set to "0".

R/W	R/W	R/W	R/W	R/W	R/W	R/W	R/W	
0	0	0	0	0	0	DTRE	STRE	Reset Value
Bit7	Bit6	Bit5	Bit4	Bit3	Bit2	Bit1	Bit0	00000011
								Address: 0x28

DTRE – enables/disables the double tap interrupt

DTRE = 0 – do not update INS1 or TDTS<1:0> in INS2 register if double tap occurs.

DTRE = 1 – update INS1 and TDTS <1:0> in INS2 with double tap events.

STRE – enables/disables single tap interrupt

STRE = 0 – do not update INS1 or TDTS<1:0> in INS2 register if single tap occurs.

STRE = 1 – update INS1 and TDTS <1:0> in INS2 with single tap events.



± 2g / 4g / 8g Tri-axis Digital Accelerometer Specifications

PART NUMBER:
KX127-1068
Rev. 2.0
05-Jun-2019

TDTC

The Tap/Double-Tap™ Counter (TDTC) register contains counter information for the detection of a double tap event. When the Directional-Tap™ ODR is 400Hz or less, every count is calculated as 1/ODR delay period. When the Directional-Tap™ ODR is 800Hz, every count is calculated as 2/ODR delay period. When the Directional-Tap™ ODR is 1600Hz, every count is calculated as 4/ODR delay period. The Directional-Tap™ ODR is user-defined per Table 19. The TDTC counts starts at the beginning of the first tap and it represents the minimum time separation between the first tap and the second tap in a double tap event. More specifically, the second tap event must end outside of the TDTC. The Kionix recommended default value is 0.3 seconds (0x78). Note that to properly change the value of this register, the PC1 bit in CNTL1 must first be set to “0”.

R/W	R/W	R/W	R/W	R/W	R/W	R/W	R/W	
TDTC7	TDTC6	TDTC5	TDTC4	TDTC3	TDTC2	TDTC1	TDTC0	Reset Value
Bit7	Bit6	Bit5	Bit4	Bit3	Bit2	Bit1	Bit0	01111000
Address: 0x29								

TTH

The Tap Threshold High (TTH) register represents the 8-bit jerk high threshold to determine if a tap is detected. The value is compared against the upper 8 bits of the 4g output value (independent of the actual g-range setting of the device). Though this is an 8-bit register, the register value is internally multiplied by two to set the high threshold. This multiplication results in a range of 0 to 510 with a resolution of two counts. The Performance Index (PI) is the jerk signal that is expected to be less than this threshold, but greater than the TTL threshold during single and double tap events. Equation 1 shows how to calculate the Performance Index. The Kionix recommended default value is 203 (0xCB). See [AN078 Getting Started](#) for recommended settings. Note that to properly change the value of this register, the PC1 bit in CNTL1 register must first be set to “0”.

$$X' = X \text{ (current)} - X \text{ (previous)}$$

$$Y' = Y \text{ (current)} - Y \text{ (previous)}$$

$$Z' = Z \text{ (current)} - Z \text{ (previous)}$$

$$PI = |X'| + |Y'| + |Z'|$$

Equation 1: Performance Index

R/W	R/W	R/W	R/W	R/W	R/W	R/W	R/W	
TTH7	TTH6	TTH5	TTH4	TTH3	TTH2	TTH1	TTH0	Reset Value
Bit7	Bit6	Bit5	Bit4	Bit3	Bit2	Bit1	Bit0	11001011
Address: 0x2A								



± 2g / 4g / 8g Tri-axis Digital Accelerometer Specifications

PART NUMBER:
KX127-1068
Rev. 2.0
05-Jun-2019

TTL

The Tap Threshold Low (TTL) register represents the 8-bit (0– 255) jerk low threshold to determine if a tap is detected. The value is compared against the upper 8 bits of the 4g output value (independent of the actual g-range setting of the device). The Performance Index (PI) is the jerk signal that is expected to be greater than this threshold and less than the TTH threshold during single and double tap events. The Kionix recommended default value is 26 (0x1A). See [AN078 Getting Started](#) for recommended settings. Note that to properly change the value of this register, the PC1 bit in CNTL1 register must first be set to “0”

R/W	R/W	R/W	R/W	R/W	R/W	R/W	R/W	
TTL7	TTL6	TTL5	TTL4	TTL3	TTL2	TTL1	TTL0	Reset Value
Bit7	Bit6	Bit5	Bit4	Bit3	Bit2	Bit1	Bit0	00011010
Address: 0x2B								

FTD

This register contains counter information for the detection of any tap event. When the Directional-Tap™ ODR is 400Hz or less, every count is calculated as 1/ODR delay period. When the Directional-Tap™ ODR is 800Hz, every count is calculated as 2/ODR delay period. When the Directional-Tap™ ODR is 1600Hz, every count is calculated as 4/ODR delay period. The Directional-Tap™ ODR is user-defined per Table 19. To ensure that only tap events are detected, these time limits are used. A tap event must be above the performance index threshold for at least the low limit (FTDL0 – FTDL2) and no more than the high limit (FTDH0 – FTDH4). The Kionix recommended default value for the high limit is 0.05 seconds and for the low limit is 0.005 seconds (0xA2). Note that to properly change the value of this register, the PC1 bit in CNTL1 must first be set to “0”.

R/W	R/W	R/W	R/W	R/W	R/W	R/W	R/W	
FTDH4	FTDH3	FTDH2	FTDH1	FTDH0	FTDL2	FTDL1	FTDL0	Reset Value
Bit7	Bit6	Bit5	Bit4	Bit3	Bit2	Bit1	Bit0	10100010
Address: 0x2C								



± 2g / 4g / 8g Tri-axis Digital Accelerometer Specifications

PART NUMBER:
KX127-1068
Rev. 2.0
05-Jun-2019

STD

This register contains counter information for the detection of a double tap event. When the Directional-Tap™ ODR is 400Hz or less, every count is calculated as 1/ODR delay period. When the Directional-Tap™ ODR is 800Hz, every count is calculated as 2/ODR delay period. When the Directional-Tap™ ODR is 1600Hz, every count is calculated as 4/ODR delay period. The Directional-Tap™ ODR is user-defined per Table 19. To ensure that only tap events are detected, this time limit is used. This register sets the total amount of time that the two taps in a double tap event can be above the PI threshold (TTL). The Kionix recommended default value for STD is 0.09 seconds (0x24). Note that to properly change the value of this register, the PC1 bit in CNTL1 must first be set to “0”.

R/W	R/W	R/W	R/W	R/W	R/W	R/W	R/W	Reset Value
STD7	STD6	STD5	STD4	STD3	STD2	STD1	STD0	00100100
Bit7	Bit6	Bit5	Bit4	Bit3	Bit2	Bit1	Bit0	
Address: 0x2D								

TLT

This register contains counter information for the detection of a tap event. When the Directional-Tap™ ODR is 400Hz or less, every count is calculated as 1/ODR delay period. When the Directional-Tap™ ODR is 800Hz, every count is calculated as 2/ODR delay period. When the Directional-Tap™ ODR is 1600Hz, every count is calculated as 4/ODR delay period. The Directional-Tap™ ODR is user-defined per Table 19. To ensure that only tap events are detected, this time limit is used. This register sets the total amount of time that the tap algorithm will count samples that are above the PI threshold (TTL) during a potential tap event. It is used during both single and double tap events. However, reporting of single taps on the physical interrupt pin INT1 or INT2 will occur at the end of the TWS. The Kionix recommended default value for TLT (TDT Latency Timer) is 0.1 seconds (0x28). Note that to properly change the value of this register, the PC1 bit in CNTL1 must first be set to “0”.

R/W	R/W	R/W	R/W	R/W	R/W	R/W	R/W	Reset Value
TLT7	TLT6	TLT5	TLT4	TLT3	TLT2	TLT1	TLT0	00101000
Bit7	Bit6	Bit5	Bit4	Bit3	Bit2	Bit1	Bit0	
Address: 0x2E								



± 2g / 4g / 8g Tri-axis Digital Accelerometer Specifications

PART NUMBER:
KX127-1068
Rev. 2.0
05-Jun-2019

TWS

This register contains counter information for the detection of single and double taps. When the Directional-Tap™ ODR is 400Hz or less, every count is calculated as 1/ODR delay period. When the Directional-Tap™ ODR is 800Hz, every count is calculated as 2/ODR delay period. When the Directional-Tap™ ODR is 1600Hz, every count is calculated as 4/ODR delay period. The Directional-Tap™ ODR is user-defined per Table 19. It defines the time window for the entire tap event, single or double, to occur. Reporting of single taps on the physical interrupt pin INT1 or INT2 will occur at the end of this tap window. The Kionix recommended default value for TWS is 0.4 seconds (0xA0). Note that to properly change the value of this register, the PC1 bit in CNTL1 must first be set to “0”.

R/W	R/W	R/W	R/W	R/W	R/W	R/W	R/W	
TWS7	TWS6	TWS5	TWS4	TWS3	TWS2	TWS1	TWS0	Reset Value
Bit7	Bit6	Bit5	Bit4	Bit3	Bit2	Bit1	Bit0	10100000
Address: 0x2F								

FFTH

The Free Fall Threshold (FFTH) register contains the threshold of the Free fall detection. This value is compared to the top 8 bits of the accelerometer 8g output (independent of the actual g-range setting of the device). See [AN078 Getting Started](#) for recommended settings. Note that to properly change the value of this register, the PC1 bit in CNTL1 must first be set to “0”.

R/W	R/W	R/W	R/W	R/W	R/W	R/W	R/W	
FFTH7	FFTH6	FFTH5	FFTH4	FFTH3	FFTH2	FFTH1	FFTH0	Reset Value
Bit7	Bit6	Bit5	Bit4	Bit3	Bit2	Bit1	Bit0	00000000
Address: 0x30								

FFC

The Free Fall Counter (FFC) register contains the counter setting of the Free fall detection. Every count is calculated as 1/ODR delay period where ODR is a Free fall ODR set by OFFI<2:0> bits in FFCNTL register. Note that to properly change the value of this register, the PC1 bit in CNTL1 register must first be set to “0”.

R/W	R/W	R/W	R/W	R/W	R/W	R/W	R/W	
FFC7	FFC6	FFC5	FFC4	FFC3	FFC2	FFC1	FFC0	Reset Value
Bit7	Bit6	Bit5	Bit4	Bit3	Bit2	Bit1	Bit0	00000000
Address: 0x31								



± 2g / 4g / 8g Tri-axis Digital Accelerometer Specifications

PART NUMBER:
KX127-1068
Rev. 2.0
05-Jun-2019

FFCNTL

The Free Fall Control (FFCNTL) register contains the control setting of the Free fall detection. Note that to properly change the value of this register, the PC1 bit in CNTL1 must first be set to "0".

R/W	R/W	R/W	R/W	R/W	R/W	R/W	R/W	
FFIE	ULMODE	0	0	DCRM	OFFI2	OFFI1	OFFI0	Reset Value
Bit7	Bit6	Bit5	Bit4	Bit3	Bit2	Bit1	Bit0	00000000
Address: 0x32								

FFIE – Free fall engine enable
 FFIE = 0 – Free fall engine disabled
 FFIE = 1 – Free fall engine enabled

ULMODE – Free fall interrupt latch/un-latch control
 ULMODE = 0 – latched
 ULMODE = 1 – unlatched

DCRM – Debounce methodology control
 DCRM = 0 – count up/down
 DCRM = 1 – count up/reset

OFFI<2:0> – Output Data Rate at which the Free fall engine performs its function.
 The default Free fall ODR is 12.5Hz.

OFFI	Output Data Rate (Hz)
000	12.5
001	25
010	50
011	100
100	200
101	400
110	800
111	1600

Table 23: Free Fall Function Output Data Rate



± 2g / 4g / 8g Tri-axis Digital Accelerometer Specifications

PART NUMBER:
KX127-1068
Rev. 2.0
05-Jun-2019

TILT_ANGLE_LL

Tilt Angle Low Limit: This register sets the low-level threshold for tilt angle detection. The low-level threshold value is compared against the upper 8 bits of the 4g output value (independent of the actual g-range setting of the device). The default tilt angle low level threshold is set to 22° from the horizontal. Note that the minimum suggested tilt angle is 10°. See [AN078 Getting Started](#) for recommended settings. Note that to properly change the value of this register, the PC1 bit in CNTL1 register must first be set to “0”.

R/W	R/W	R/W	R/W	R/W	R/W	R/W	R/W	
LL7	LL6	LL5	LL4	LL3	LL2	LL1	LL0	Reset Value
Bit7	Bit6	Bit5	Bit4	Bit3	Bit2	Bit1	Bit0	00001100
Address: 0x34								

TILT_ANGLE_HL

Tilt Angle High Limit: This register sets the high-level threshold for tilt angle detection. The high-level threshold is used by an internal algorithm to eliminate dynamic g-variations caused by the device movement. Instead, only static g-variation (gravity) caused by the actual tilt changes are used. The high-level threshold value is compared against the upper 8 bits of the 4g output value (independent of the actual g-range setting of the device). The default tilt angle high level threshold is set to just above 1g plus some margin of error to account for external factors (e.g. device mounting). See [AN078 Getting Started](#) for recommended settings. Note that to properly change the value of this register, the PC1 bit in CNTL1 register must first be set to “0”.

R/W	R/W	R/W	R/W	R/W	R/W	R/W	R/W	
HL7	HL6	HL5	HL4	HL3	HL2	HL1	HL0	Reset Value
Bit7	Bit6	Bit5	Bit4	Bit3	Bit2	Bit1	Bit0	00101010
Address: 0x35								

HYST_SET

This register sets the Hysteresis that is placed in between the Screen Rotation states. The KX127 ships from the factory with HYST_SET set to ±15° of hysteresis. Note that when writing a new value to this register the current values of RES0 and RES1 must be preserved. These values are set at the factory and must not change. Note that to properly change the value of this register, the PC1 bit in CNTL1 register must first be set to “0”.

R/W	R/W	R/W	R/W	R/W	R/W	R/W	R/W	
Reserved	Reserved	HYST5	HYST4	HYST3	HYST2	HYST1	HYST0	Reset Value
Bit7	Bit6	Bit5	Bit4	Bit3	Bit2	Bit1	Bit0	00010100
Address: 0x36								



± 2g / 4g / 8g Tri-axis Digital Accelerometer Specifications

PART NUMBER:
KX127-1068
Rev. 2.0
05-Jun-2019

LP_CNTL

Low Power Control: The Averaging Filter Control setting can be used in the optimization of current and noise performance of the accelerometer and can be tested using [Kionix FlexSet™ Performance Optimization Tool](#). More specifically, this setting determines the number of internal acceleration samples to be averaged in Low Power mode. Also, it determines the number of internal acceleration samples to be averaged for digital engines operation (Directional-Tap™, Tilt, Wake-Up, Back-to-Sleep, Free fall, Pedometer) both in *High Resolution* and *Low Power* modes. Note that to properly change the value of this register, the PC1 bit in CNTL1 must first be set to “0”.

R/W	R/W	R/W	R/W	R/W	R/W	R/W	R/W	Reset Value
Reserved	AVC2	AVC1	AVC0	Reserved	Reserved	Reserved	Reserved	01001011
Bit7	Bit6	Bit5	Bit4	Bit3	Bit2	Bit1	Bit0	
Address: 0x37								

AVC<2:0> – Averaging Filter Control. The default setting is 16 samples and was found to work for most case.

- 000 = No Averaging
- 001 = 2 Samples Averaged
- 010 = 4 Samples Averaged
- 011 = 8 Samples Averaged
- 100 = 16 Samples Averaged (default)
- 101 = 32 Samples Averaged
- 110 = 64 Samples Averaged
- 111 = 128 Samples Averaged

Reserved – these bits are reserved and their value should not be changed.



± 2g / 4g / 8g Tri-axis Digital Accelerometer Specifications

PART NUMBER:
KX127-1068
Rev. 2.0
05-Jun-2019

WUFTH, BTSWUFTH and BTSTH

Wake-up Function Threshold (WUFTH), Back-to-Sleep and Wake-Up Function Threshold (BTSWUFTH), and Back-to-Sleep Threshold (BTSTH) registers set the thresholds for Wake-up and Back-to-Sleep engines. Note that to properly change the value of this register, the PC1 bit in CNTL1 must first be set to “0”.

R/W	R/W	R/W	R/W	R/W	R/W	R/W	R/W	Address	Register	Reset Value
WUFTH7	WUFTH6	WUFTH5	WUFTH4	WUFTH3	WUFTH2	WUFTH1	WUFTH0	0x3C	WUFTH	10000000
0	BTSTH10	BTSTH9	BTSTH8	0	WUFTH10	WUFTH9	WUFTH8	0x3D	BTSWUFTH	00000000
BTSTH7	BTSTH6	BTSTH5	BTSTH4	BTSTH3	BTSTH2	BTSTH1	BTSTH0	0x3E	BTSTH	10000000
Bit7	Bit6	Bit5	Bit4	Bit3	Bit2	Bit1	Bit0			

WUFTH<10:0>: Threshold for wake-up interrupt

BTSTH<10:0>: Threshold for Back-to-Sleep interrupt

The threshold values set by WUFTH<10:0> and BTSTH<10:0> are compared to the top 11 bits of the accelerometer 8g output (regardless of GSEL<1:0> setting in CNTL1 register). This results in threshold resolution of 3.9 mg/count per Equation 2.

$$2^{11} \text{ counts} / 8 \text{ g} = 2048 \text{ counts} / 8 \text{ g} = 256 \text{ counts/g or } 3.9 \text{ mg/count}$$

Equation 2: Wake-Up / Back-to-Sleep Resolution Calculations

BTSC

This register is the initial count register for the BTS motion detection timer (0 to 255 counts). Every count is calculated as 1/ODR delay period, where the Back-to-Sleep ODR is user-defined per Table 21. Note that to properly change the value of this register, the PC1 bit in CNTL1 must first be set to “0”.

R/W	R/W	R/W	R/W	R/W	R/W	R/W	R/W	Reset Value
BTSC7	BTSC6	BTSC5	BTSC4	BTSC3	BTSC2	BTSC1	BTSC0	00000000
Bit7	Bit6	Bit5	Bit4	Bit3	Bit2	Bit1	Bit0	
Address: 0x3F								



± 2g / 4g / 8g Tri-axis Digital Accelerometer Specifications

PART NUMBER:
KX127-1068
Rev. 2.0
05-Jun-2019

WUFC

The Wake-Up Function Counter (WUFC) is the initial count register for the motion detection timer (0 to 255 counts). Every count is calculated as 1/ODR delay period, where the ODR is user-defined per Table 20. Note that to properly change the value of this register, the PC1 bit in CNTL1 must first be set to "0".

R/W	R/W	R/W	R/W	R/W	R/W	R/W	R/W	
WUFC7	WUFC6	WUFC5	WUFC4	WUFC3	WUFC2	WUFC1	WUFC0	Reset Value
Bit7	Bit6	Bit5	Bit4	Bit3	Bit2	Bit1	Bit0	00000000
Address: 0x40								

PED_STPWM_L and PED_STPWM_H

Pedometer Step Counter Watermark Low and High registers set the 16-bit count value used as a watermark threshold for step counting. When the threshold value is exceeded, the interrupt will be reflected the STPWMI bit in INS2 register and on physical interrupt pin if configured. Note that to properly change the value of these registers, the PC1 and PDE bits in CNTL1 must first be set to "0".

PED_STPWM_L register holds the lower 8 bits of the count value.

R/W	R/W	R/W	R/W	R/W	R/W	R/W	R/W	
STPWM7	STPWM6	STPWM5	STPWM4	STPWM3	STPWM2	STPWM1	STPWM0	Reset Value
Bit7	Bit6	Bit5	Bit4	Bit3	Bit2	Bit1	Bit0	00000000
Address: 0x41								

PED_STPWM_H register holds the upper 8 bits of the count value.

R/W	R/W	R/W	R/W	R/W	R/W	R/W	R/W	
STPWM15	STPWM14	STPWM13	STPWM12	STPWM11	STPWM10	STPWM9	STPWM8	Reset Value
Bit7	Bit6	Bit5	Bit4	Bit3	Bit2	Bit1	Bit0	00000000
Address: 0x42								

PED_CNTL1

Pedometer Control register 1 (PED_CNTL1). The setting of this register is affected by pedometer engine ODR selection. See [AN073 Getting Started with Pedometer](#) for more information about recommended register setup. Note that to properly change the value of these registers, the PC1 and PDE bits in CNTL1 must first be set to "0".

R/W	R/W	R/W	R/W	R/W	R/W	R/W	R/W	
0	STP_TH2	STP_TH1	STP_TH0	MAG_SCALE3	MAG_SCALE2	MAG_SCALE1	MAG_SCALE0	Reset Value
Bit7	Bit6	Bit5	Bit4	Bit3	Bit2	Bit1	Bit0	01000110
Address: 0x43								



± 2g / 4g / 8g Tri-axis Digital Accelerometer Specifications

PART NUMBER:
KX127-1068
Rev. 2.0
05-Jun-2019

STP_TH<2:0> – It is used to allow a successful start for step detection. It is a threshold for discarding step counting if not enough steps are coming.

000 = No steps
 001 = 2 steps
 010 = 4 steps
 011 = 6 steps
 100 = 8 steps
 101 = 10 steps
 110 = 12 steps
 111 = 14 steps

MAG_SCALE<3:0> – Scaling factor for the input signal (x, y, z).

PED_CNTL2

Pedometer Control register 2 (PED_CNTL2). The setting of this register is affected by pedometer engine ODR selection. See [AN073 Getting Started with Pedometer](#) for more information about recommended register setup. Note that to properly change the value of these registers, the PC1 and PDE bits in CNTL1 must first be set to “0”.

R/W	R/W	R/W	R/W	R/W	R/W	R/W	R/W	
0	HPS2	HPS1	HPS0	PED_ODR3	PED_ODR2	PED_ODR1	PED_ODR0	Reset Value
Bit7	Bit6	Bit5	Bit4	Bit3	Bit2	Bit1	Bit0	00111100
Address: 0x44								

HPS<2:0> – A Scaling factor for the output from the high-pass filter.

000 = 1
 001 = 2
 010 = 4
 011 = 8
 100 = 16
 101 = 32
 110 = 64
 111 = 128

PED_ODR<3:0> – Pedometer Engine ODR Select

1100 = 100Hz
 0110 = 50Hz



± 2g / 4g / 8g Tri-axis Digital Accelerometer Specifications

PART NUMBER:
KX127-1068
Rev. 2.0
05-Jun-2019

PED_CNTL3

Pedometer Control register 3 (PED_CNTL3). See [AN073 Getting Started with Pedometer](#) for more information about recommended register setup. Note that to properly change the value of these registers, the PC1 and PDE bits in CNTL1 must first be set to "0".

R/W	R/W	R/W	R/W	R/W	R/W	R/W	R/W	Reset Value
0	0	FCB2	FCB1	FCB0	FCA2	FCA1	FCA0	00001110
Bit7	Bit6	Bit5	Bit4	Bit3	Bit2	Bit1	Bit0	
Address: 0x45								

FCB<2:0> – Scaling factor internal high-pass filter. Values: 0, 1, ..., 7.

```

000 = 0
001 = 1
010 = 2
011 = 3
100 = 4
101 = 5
110 = 6
111 = 7

```

FCA<2:0> – Scaling factor internal high-pass filter.

```

000 = 1
001 = 2
010 = 4
011 = 8
100 = 16
101 = 32
110 = 64
111 = 128

```



± 2g / 4g / 8g Tri-axis Digital Accelerometer Specifications

PART NUMBER:
KX127-1068
Rev. 2.0
05-Jun-2019

PED_CNTL4

Pedometer Control register 4 (PED_CNTL4). See [AN073 Getting Started with Pedometer](#) for more information about recommended register setup. Note that to properly change the value of these registers, the PC1 and PDE bits in CNTL1 must first be set to "0".

R/W	R/W	R/W	R/W	R/W	R/W	R/W	R/W	
0	B_CNT2	B_CNT1	B_CNT0	A_H3	A_H2	A_H1	A_H0	Reset Value
Bit7	Bit6	Bit5	Bit4	Bit3	Bit2	Bit1	Bit0	00011111
Address: 0x46								

B_CNT<2:0> – Samples below the zero threshold before setting. Values: 0, 1, ..., 7.

000 = 0
001 = 1
010 = 2
011 = 3
100 = 4
101 = 5
110 = 6
111 = 7

A_H<3:0> – Maximum area of the peak (maximum impact from the floor). Values: 0, 1, ..., 15.

0000 = 0
0001 = 1
0010 = 2
0011 = 3
0100 = 4
0101 = 5
0110 = 6
0111 = 7
1000 = 8
1001 = 9
1010 = 10
1011 = 11
1100 = 12
1101 = 13
1110 = 14
1111 = 15



± 2g / 4g / 8g Tri-axis Digital Accelerometer Specifications

PART NUMBER:
KX127-1068
Rev. 2.0
05-Jun-2019

PED_CNTL5

Pedometer Control register 5 (PED_CNTL5). The setting of this register is affected by pedometer engine ODR selection. See [AN073 Getting Started with Pedometer](#) for more information about recommended register setup. Note that to properly change the value of this register, the PC1 and PDE bits in CNTL1 must first be set to “0”.

R/W	R/W	R/W	R/W	R/W	R/W	R/W	R/W	Reset Value
A_L7	A_L6	A_L5	A_L4	A_L3	A_L2	A_L1	A_L0	00111100
Bit7	Bit6	Bit5	Bit4	Bit3	Bit2	Bit1	Bit0	
Address: 0x47								

A_L<7:0> – Minimum area of the peak (minimum impact from the floor). Values: 0, 1, ..., 255.

PED_CNTL6

Pedometer Control register 6 (PED_CNTL6). The setting of this register is affected by pedometer engine ODR selection. See [AN073 Getting Started with Pedometer](#) for more information about recommended register setup. Note that to properly change the value of these registers, the PC1 and PDE bits in CNTL1 must first be set to “0”.

R/W	R/W	R/W	R/W	R/W	R/W	R/W	R/W	Reset Value
0	0	M_H5	M_H4	M_H3	M_H2	M_H1	M_H0	00010100
Bit7	Bit6	Bit5	Bit4	Bit3	Bit2	Bit1	Bit0	
Address: 0x48								

M_H<5:0> – Maximum time interval for the peak. Values: 0, 1, ..., 63.

PED_CNTL7

Pedometer Control register 7 (PED_CNTL7). See [AN073 Getting Started with Pedometer](#) for more information about recommended register setup. Note that to properly change the value of these registers, the PC1 and PDE bits in CNTL1 must first be set to “0”.

R/W	R/W	R/W	R/W	R/W	R/W	R/W	R/W	Reset Value
M_L7	M_L6	M_L5	M_L4	M_L3	M_L2	M_L1	M_L0	00000110
Bit7	Bit6	Bit5	Bit4	Bit3	Bit2	Bit1	Bit0	
Address: 0x49								

M_L<7:0> – Minimum time interval for the peak. Values: 0, 1, ..., 255.



± 2g / 4g / 8g Tri-axis Digital Accelerometer Specifications

PART NUMBER:
KX127-1068
Rev. 2.0
05-Jun-2019

PED_CNTL8

Pedometer Control register 8 (PED_CNTL8). The setting of this register is affected by pedometer engine ODR selection. See [AN073 Getting Started with Pedometer](#) for more information about recommended register setup. Note that to properly change the value of these registers, the PC1 and PDE bits in CNTL1 must first be set to “0”.

R/W	R/W	R/W	R/W	R/W	R/W	R/W	R/W	Reset Value
T_L7	T_L6	T_L5	T_L4	T_L3	T_L2	T_L1	T_L0	00000101
Bit7	Bit6	Bit5	Bit4	Bit3	Bit2	Bit1	Bit0	
Address: 0x4A								

T_L<7:0> – Time window for noise and delay time. Values: 0, 1, ..., 255.

PED_CNTL9

Pedometer Control register 9 (PED_CNTL9). The setting of this register is affected by pedometer engine ODR selection. See [AN073 Getting Started with Pedometer](#) for more information about recommended register setup. Note that to properly change the value of these registers, the PC1 and PDE bits in CNTL1 must first be set to “0”.

R/W	R/W	R/W	R/W	R/W	R/W	R/W	R/W	Reset Value
0	0	T_M5	T_M4	T_M3	T_M2	T_M1	T_M0	00010110
Bit7	Bit6	Bit5	Bit4	Bit3	Bit2	Bit1	Bit0	
Address: 0x4B								

T_M<5:0> – Time interval to prevent overflowing. Values: 0, 1, ...,63.

PED_CNTL10

Pedometer Control register 10 (PED_CNTL10). The setting of this register is affected by pedometer engine ODR selection. See [AN073 Getting Started with Pedometer](#) for more information about recommended register setup. Note that to properly change the value of these registers, the PC1 and PDE bits in CNTL1 must first be set to “0”.

R/W	R/W	R/W	R/W	R/W	R/W	R/W	R/W	Reset Value
0	0	T_P5	T_P4	T_P3	T_P2	T_P1	T_P0	00010011
Bit7	Bit6	Bit5	Bit4	Bit3	Bit2	Bit1	Bit0	
Address: 0x4C								

T_P<5:0> – Minimum time interval for a single stride. Values: 0, 1, ...,63.



± 2g / 4g / 8g Tri-axis Digital Accelerometer Specifications

PART NUMBER:
KX127-1068
Rev. 2.0
05-Jun-2019

SELF_TEST

Self-Test: When 0xCA value is written to this register, the MEMS self-test function is enabled. Electrostatic-actuation of the accelerometer, results in a DC shift of the X, Y and Z axis outputs.

W	W	W	W	W	W	W	W	
0	0	0	0	0	0	0	0	Reset Value
Bit7	Bit6	Bit5	Bit4	Bit3	Bit2	Bit1	Bit0	00000000
								Address: 0x4D

To perform the self-test, the following procedure is required:

1. Set STPOL bit to 1 in INC1 register to set the polarity of the self-test mode to positive.
2. Set PC1 bit to 1 in CNTL1 register to enable KX127-1068.
3. Write 0xCA to this register to enable the MEMS self-test function.

Once the self-test function is enabled, electrostatic-actuation of the accelerometer, results in a DC shift of the X, Y and Z axis outputs. Calculate the self-test (ST) response using Equation 3:

$$ST[g] = \frac{(OUTPUT_{ST_ON}[counts]) - (OUTPUT_{ST_OFF}[counts])}{Sensitivity \left[\frac{counts}{g} \right]}$$

Equation 3: Self-Test (ST) Response Calculation

The self test response should be compared to the product specifications (Table 1) to determine if the MEMS response is within the specified range.

To disable the self-test mode any of the following methods can be used:

- Power cycle KX127-1068
- Or
- Perform software reset by setting SRST bit to 1 in CNTL2 register
- Or
- 1. Set PC1 bit to 0 in CNTL1 register to set KX127-1068 in Standby mode.
- 2. Write 0x00 to this register to disable the self-test mode.

Note, this is a write-only register. Read back value from this register will always be 0x00.

	± 2g / 4g / 8g Tri-axis Digital Accelerometer Specifications	PART NUMBER: KX127-1068 Rev. 2.0 05-Jun-2019
---	---	---

BUF_CNTL1

The Buffer Control 1 (BUF_CNTL1) register controls the buffer sample threshold. Note that to properly change the value of this register, the PC1 bit in CNTL1 register must first be set to “0”.

R/W	R/W	R/W	R/W	R/W	R/W	R/W	R/W	
SMP_TH7	SMP_TH6	SMP_TH5	SMP_TH4	SMP_TH3	SMP_TH2	SMP_TH1	SMP_TH0	Reset Value
Bit7	Bit6	Bit5	Bit4	Bit3	Bit2	Bit1	Bit0	00000000
Address: 0x5A								

SMP_TH[9:0] Sample Threshold – determines the number of samples that will trigger a watermark interrupt or will be saved prior to a trigger event. When BRES=1, the maximum number of samples is 342. When BRES=0, the maximum number of samples is 683. The minimum number of samples must be greater than or equal to 2.

Note: SMP_TH[9:8] bits are located in BUF_CNTL2 register.

Buffer Model	Sample Function
Bypass	None
FIFO	Specifies how many buffer sample are needed to trigger a watermark interrupt.
Stream	Specifies how many buffer samples are needed to trigger a watermark interrupt.
Trigger	Specifies how many buffer samples before the trigger event are retained in the buffer.
FILO	Specifies how many buffer samples are needed to trigger a watermark interrupt.

Table 24: Sample Threshold Operation by Buffer Mode



± 2g / 4g / 8g Tri-axis Digital Accelerometer Specifications

PART NUMBER:
KX127-1068
Rev. 2.0
05-Jun-2019

BUF_CNTL2

The Buffer Control 2 (BUF_CNTL2) register controls sample buffer operation. Note that to properly change the value of this register, the PC1 bit in CNTL1 register must first be set to “0”.

R/W	R/W	R/W	R/W	R/W	R/W	R/W	R/W	
BUFE	BRES	BFIE	0	SMP_TH9	SMP_TH8	BM1	BM0	Reset Value
Bit7	Bit6	Bit5	Bit4	Bit3	Bit2	Bit1	Bit0	00000000
Address: 0x5B								

BUFE controls activation of the sample buffer.

BUFE = 0 – sample buffer inactive

BUFE = 1 – sample buffer active

Note: Disabling the sample buffer (BUFE = 0) will clear the buffer. The buffer will also be cleared (1) following write to BUF_CLEAR register and/or (2) after setting PC1 bit in CNTL1 register to 0 (standby mode).

BRES determines the resolution of the acceleration data samples collected by the sample buffer.

BRES = 0 – 8-bit samples are accumulated in the buffer

BRES = 1 – 16-bit samples are accumulated in the buffer

BFIE buffer full interrupt enable bit

BFIE = 0 – buffer full interrupt is disabled

BFIE = 1 – buffer full interrupt is enabled and updated in INS2

BM1, BM0 selects the operating mode of the sample buffer per Table 25

BM1	BM0	Mode	Description
0	0	FIFO	The buffer collects 683 sets of 8-bit low resolution values or 342 sets of 16-bit high resolution values and then stops collecting data, collecting new data only when the buffer is not full.
0	1	Stream	The buffer holds the last 683 sets of 8-bit low resolution values or 342 sets of 16-bit high resolution values. Once the buffer is full, the oldest data is discarded to make room for newer data.
1	0	Trigger	When a trigger event occurs, the buffer holds the last data set of SMP_TH[9:0] samples before the trigger event and then continues to collect data until full. New data is collected only when the buffer is not full.
1	1	FILO	The buffer holds the last 683 sets of 8-bit low resolution values or 342 sets of 16-bit high resolution values. Once the buffer is full, the oldest data is discarded to make room for newer data. Reading from the buffer in this mode will return the most recent data first.

Table 25: Selected Buffer Mode



± 2g / 4g / 8g Tri-axis Digital Accelerometer Specifications

PART NUMBER:
KX127-1068
Rev. 2.0
05-Jun-2019

BUF_STATUS_1 and BUF_STATUS_2

Buffer Status: These register reports the status of the sample buffer. Note that BUF_STATUS_1 and BUF_STATUS_2 registers may have a delay of up to 1 μ sec to update the sample level after a buffer read.

R	R	R	R	R	R	R	R	BUF_STATUS_1
SMP_LEV7	SMP_LEV6	SMP_LEV5	SMP_LEV4	SMP_LEV3	SMP_LEV2	SMP_LEV1	SMP_LEV0	Reset Value
Bit7	Bit6	Bit5	Bit4	Bit3	Bit2	Bit1	Bit0	00000000
Address: 0x5C								

R	R	R	R	R	R	R	R	BUF_STATUS_2
BUF_TRIG	0	0	0	SMP_LEV11	SMP_LEV10	SMP_LEV9	SMP_LEV8	Reset Value
Bit7	Bit6	Bit5	Bit4	Bit3	Bit2	Bit1	Bit0	00000000
Address: 0x5D								

SMP_LEV [11:0] Sample Level: reports the number of data bytes that have been stored in the sample buffer. When BRES=1, this count will increase by 6 for each 3-axis sample in the buffer. When BRES=0, the count will increase by 3 for each 3-axis sample. If this register reads 0, no data has been stored in the buffer.

BUF_TRIG reports the status of the buffer's trigger function if this mode has been selected.

A trigger event is the combined interrupt events of
 BUF_TRIG = FFS | TDTS1 | TDTS0 | WUFS | TPS | STPWMI | TRIG

This bit is also gets cleared after writing to BUF_CLEAR register. This will prevent Buffer Full interrupt from firing while TRIG pin remains de-asserted.

BUF_CLEAR

Latched buffer status information and the entire sample buffer are cleared when any data is written to this register. This causes the sample level bits SMP_LEV[11:0] to be cleared in BUF_STATUS_1 and BUF_STATUS_2 registers. In addition, if the sample buffer is set to Trigger mode, the BUF_TRIG bit in BUF_STATUS_2 is cleared too. Finally, the BFI and WMI bits in INS2 will be cleared and physical interrupt latched pin will be changed to its inactive state.

W	W	W	W	W	W	W	W	
X	X	X	X	X	X	X	X	Reset Value
Bit7	Bit6	Bit5	Bit4	Bit3	Bit2	Bit1	Bit0	00000000
Address: 0x5E								



± 2g / 4g / 8g Tri-axis Digital Accelerometer Specifications

PART NUMBER:

KX127-1068

Rev. 2.0

05-Jun-2019

BUF_READ

Buffer output register: Data in the buffer can be read while continuing to fill according to the BRES and BM<1:0> settings in BUF_CNTL2. To prevent any data loss, data must be read on a single byte basis or as complete datasets (6 bytes for 16-bit samples and 3 bytes for 8-bit samples as set by BRES bit in BUF_CNTL2) using auto-increment (burst read). In STREAM, TRIGGER (before the trigger event), and FILO modes any burst read of the buffer shall last no longer than the current 1/ODR cycle minus 30µsec (1/ODR-30µsec) for asynchronous reads and no longer than twice the current 1/ODR cycle minus 30µsec (2*(1/ODR)-30µsec) for synchronous reads. In FIFO mode, there is no restriction other than the buffer must not run out of space. Output data is in 2's Complement format.

R	R	R	R	R	R	R	R	
X	X	X	X	X	X	X	X	Reset Value
Bit7	Bit6	Bit5	Bit4	Bit3	Bit2	Bit1	Bit0	00000000
Address: 0x5F								



± 2g / 4g / 8g Tri-axis Digital Accelerometer Specifications

PART NUMBER:
KX127-1068
Rev. 2.0
05-Jun-2019

Embedded Applications

Orientation Detection Feature

The orientation detection feature of the KX127 will report changes in face up, face down, ± vertical and ± horizontal orientation. This intelligent embedded algorithm considers very important factors that provide accurate orientation detection from low cost tri-axis accelerometers. Factors such as: hysteresis, device orientation angle and delay time are described below as these techniques are utilized inside the KX127

Hysteresis

A 45° tilt angle threshold seems like a good choice because it is halfway between 0° and 90°. However, a problem arises when the user holds the device near 45°. Slight vibrations, noise and inherent sensor error will cause the acceleration to go above and below the threshold rapidly and randomly, so the screen will quickly flip back and forth between the 0° and the 90° orientations. This problem is avoided in the KX127 by choosing a 30° threshold angle. With a 30° threshold, the screen will not rotate from 0° to 90° until the device is tilted to 60° (30° from 90°). To rotate back to 0°, the user must tilt back to 30°, thus avoiding the screen flipping problem. This example essentially applies ± 15° of hysteresis in between the four screen rotation states. Table 26 shows the acceleration limits implemented for $\phi_T = 30^\circ$.

Orientation	X Acceleration (g)	Y Acceleration (g)
0°/360°	$-0.5 < a_x < 0.5$	$a_y > 0.866$
90°	$a_x > 0.866$	$-0.5 < a_y < 0.5$
180°	$-0.5 < a_x < 0.5$	$a_y < -0.866$
270°	$a_x < -0.866$	$-0.5 < a_y < 0.5$

Table 26: Acceleration at the four orientations with ± 15° of hysteresis

The KX127 allows the user to change the amount of hysteresis in between the four screen rotation states. By simply writing to the HYST_SET register, the user can adjust the amount of hysteresis up to ± 45°. The plot in Figure 11 shows the typical amount of hysteresis applied for a given digital count value of HYST_SET.



± 2g / 4g / 8g Tri-axis Digital Accelerometer Specifications

PART NUMBER:
KX127-1068
Rev. 2.0
05-Jun-2019

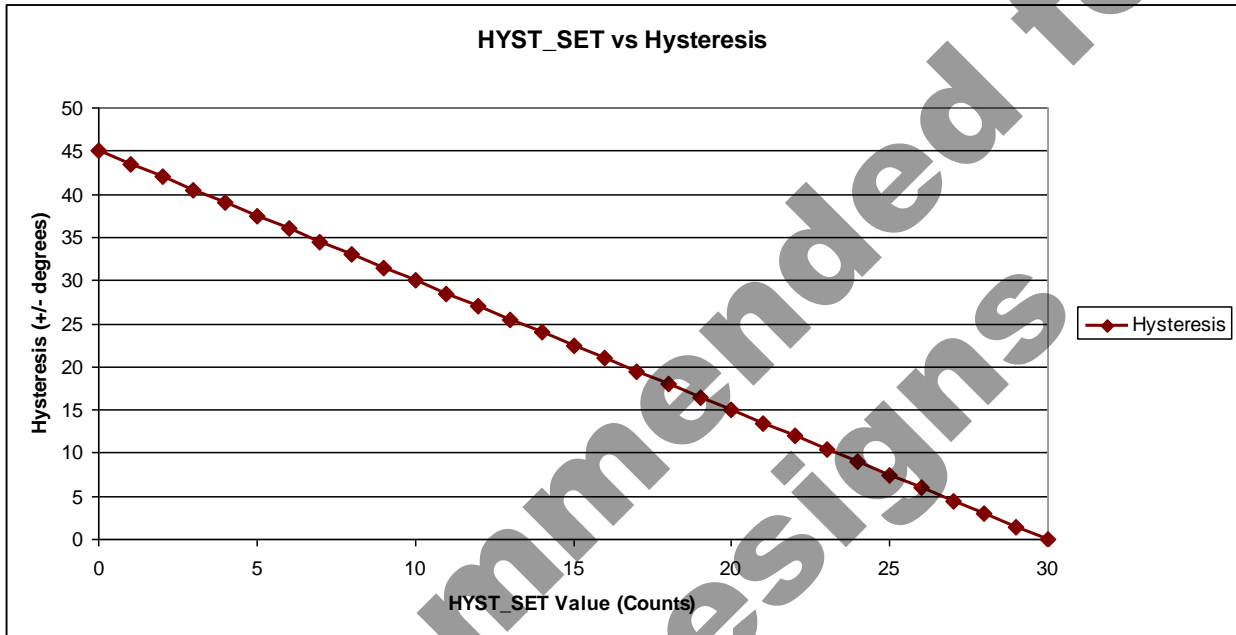

Figure 11: HYST_SET vs Hysteresis

Device Orientation Angle (aka Tilt Angle)

To ensure that horizontal and vertical device orientation changes are detected, even when it isn't in the ideal vertical orientation – where the angle θ in Figure 12 is 90° , the KX127 considers device orientation angle in its algorithm.

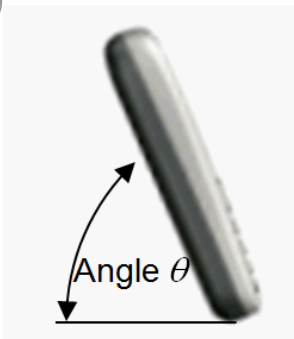

Figure 12: Device Orientation Angle

As the angle in Figure 12 is decreased, the maximum gravitational acceleration on the X-axis or Y-axis will also decrease. Therefore, when the angle becomes small enough, the user will not be able to make



± 2g / 4g / 8g Tri-axis Digital Accelerometer Specifications

PART NUMBER:

KX127-1068

Rev. 2.0

05-Jun-2019

the screen orientation change. When the device orientation angle approaches 0° (device is flat on a desk or table), $a_x = a_y = 0g$, $a_z = +1g$, and there is no way to determine which way the screen should be oriented, the internal algorithm determines that the device is in either the face-up or face-down orientation, depending on the sign of the z-axis. The KX127 will only change the screen orientation when the orientation angle is above the factory-defaulted/user-defined threshold set in the TILT_ANGLE_LL register. Equation 4 can be used to determine what value to write to the TILT_ANGLE_LL register to set the device orientation angle. The value for TILT_ANGLE_HL is preset at the factory but can be adjusted in special cases (e.g. to reduce the effect of transient g-variation such as when device is being moved rather than just being rotated).

$$\text{TILT_ANGLE_LL (counts)} = \sin \theta * (32 \text{ (counts/g)})$$

Equation 4: Tilt Angle Threshold

Tilt Timer

The 8-bit register, TILT_TIMER can be used to qualify changes in orientation. The KX127 does this by incrementing a counter with a size that is specified by the value in TILT_TIMER for each set of acceleration samples to verify that a change to a new orientation state is maintained. A user defined Tilt Position output data rate (ODR) as set by OTP<1:0> bits in CNTL3 register, determines the time period for each sample. Equation 5 shows how to calculate the TILT_TIMER register value for a desired delay time.

$$\text{TILT_TIMER (counts)} = \text{Delay Time (sec)} \times \text{Tilt Position ODR (Hz)}$$

Equation 5: Tilt Position Delay Time

	± 2g / 4g / 8g Tri-axis Digital Accelerometer Specifications	PART NUMBER: KX127-1068 Rev. 2.0 05-Jun-2019
---	---	---

Motion Interrupt Feature Description

The Motion interrupt feature of the KX127 reports qualified changes in the high-pass filtered acceleration based on the Wake-Up Threshold (WUFTH) and Back-to-Sleep Threshold (BTSTH). If the high-pass filtered acceleration on any axis is greater than the user-defined Wake-Up Threshold (WUFTH), the device has transitioned from an inactive state to an active state. On the other hand, if the high-pass filtered acceleration on any axis is less than the user-defined Back-to-Sleep Threshold (BTSTH), the device has transitioned from an active state to an inactive state. Equation 6 shows how to calculate the WUFTH and BTSTH register values for a desired wake-up and back-to-sleep thresholds. The wake-up engine function is independent of the user selected g-range and resolution.

$$\text{WUFTH (counts)} = \text{Wake-Up Threshold (g)} \times 256 \text{ (counts/g)}$$

$$\text{BTSTH (counts)} = \text{Back-to-Sleep Threshold (g)} \times 256 \text{ (counts/g)}$$

Equation 6: Wake-Up/Back-to-Sleep Threshold

An 8-bit raw unsigned value represents a counter that permits the user to qualify each active/inactive state change. Note that each Wake-Up Function Counter (WUFC) count qualifies 1 (one) user-defined Wake-Up Function ODR period as set by OWUF<2:0> bits in CNTL3 register. Similarly, each Back-to-Sleep Counter (BTSC) count qualifies 1 (one) user-defined Back-to-Sleep function ODR period as set by OBTS<2:0> bits in CNTL4 register. Equation 7 shows how to calculate the WUFC and BTSC register values for a desired Wake-Up and Back-to-Sleep delay times.

$$\text{WUFC (counts)} = \text{Wake-Up Delay Time (sec)} \times \text{Wake-up Function ODR (Hz)}$$

$$\text{BTSC (counts)} = \text{Back-to-Sleep Delay Time (sec)} \times \text{Back-to-Sleep Function ODR (Hz)}$$

Equation 7: Wake-Up and Back-to-Sleep counts

Wake-Up function

While the part is in inactive state, the algorithm evaluates differential measurement between each new acceleration data point with the preceding one and evaluates it against the Wake-Up Function Threshold (WUFTH). When the differential measurement is greater than WUFTH, the Wake-up function counter (WUFC) starts the count. Differential measurements are now calculated based on the difference between the current acceleration and the acceleration when the counter started. The part will report that motion has occurred at the end of the count assuming each differential measurement has remained above the threshold. If at any moment during the count the differential measurement falls below the threshold, the counter will stop the count and the part will remain in inactive state.

To illustrate how the algorithm works, consider the Figure 13 that shows the latched response of the motion detection algorithm with the Wake-up Function Counter (WUFC) set to 10 counts. Note how the difference



± 2g / 4g / 8g Tri-axis Digital Accelerometer Specifications

PART NUMBER:
KX127-1068
Rev. 2.0
05-Jun-2019

between the acceleration sample marked in *red* and the one marked in *green* resulted in a differential measurement represented with *orange* bar being above the Wake-Up Function Threshold (WUFTH). At this point, the Wake-up Function Counter (WUFC) begins to count number of counts stored in WUFC register and the wake-up algorithm will evaluate the difference between each new acceleration measurement and the measurement marked in *green* that will remain a reference measurement for the duration of the counter count. At the end of the count, assuming all differential measurements were larger than Wake-Up Function Threshold (WUFTH), as is the case in the example showed in Figure 13, a motion event will be reported.

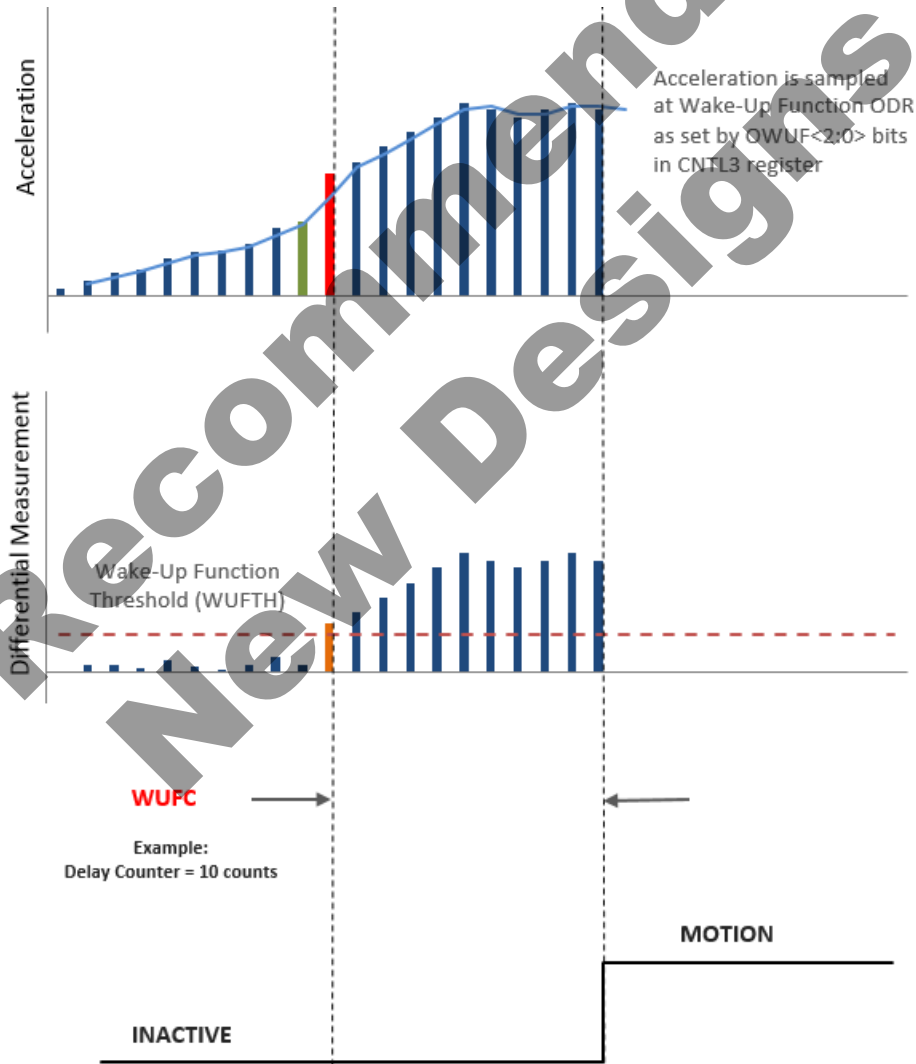

Figure 13: Latched Motion Interrupt Response with WUFC

	± 2g / 4g / 8g Tri-axis Digital Accelerometer Specifications	PART NUMBER: KX127-1068 Rev. 2.0 05-Jun-2019
---	---	---

Back-to-Sleep function

While the part is in active state, the algorithm evaluates differential measurement between each new acceleration data point with the preceding one and evaluates it against the Back-to-Sleep Threshold (BTSTH). When the differential measurement is less than BTSTH threshold, the Back-to-Sleep Counter (BTSC) starts the count. Differential measurements are now calculated based on the difference between the current acceleration and the acceleration when the counter started. The part will report that motion has not occurred at the end of the count assuming each differential measurement has remained below the threshold. If at any moment during the count the differential measurement goes above the threshold, the counter will stop the count and the part will remain in active state.

Figure 14 shows the latched response of the motion detection algorithm with Back-to-Sleep Counter (BTSC) set to 10 counts. Note how the difference between the acceleration sample marked in *red* and the one marked in *green* resulted in a differential measurement represented with *orange* bar being below the Back-to-Sleep Threshold (BTSTH). At this point, the counter begins to count number of counts stored in BTSC register and the back-to-sleep algorithm will evaluate the difference between each new acceleration measurement and the measurement marked in *green* that will remain a reference measurement for the duration of the counter count. At the end of the count, assuming all differential measurements were below Back-to-Sleep Threshold (BTSTH), as is the case in the example showed in Figure 14, an inactive mode will be reported.

Not Recommended for New Designs



± 2g / 4g / 8g Tri-axis Digital Accelerometer Specifications

PART NUMBER:
KX127-1068
Rev. 2.0
05-Jun-2019

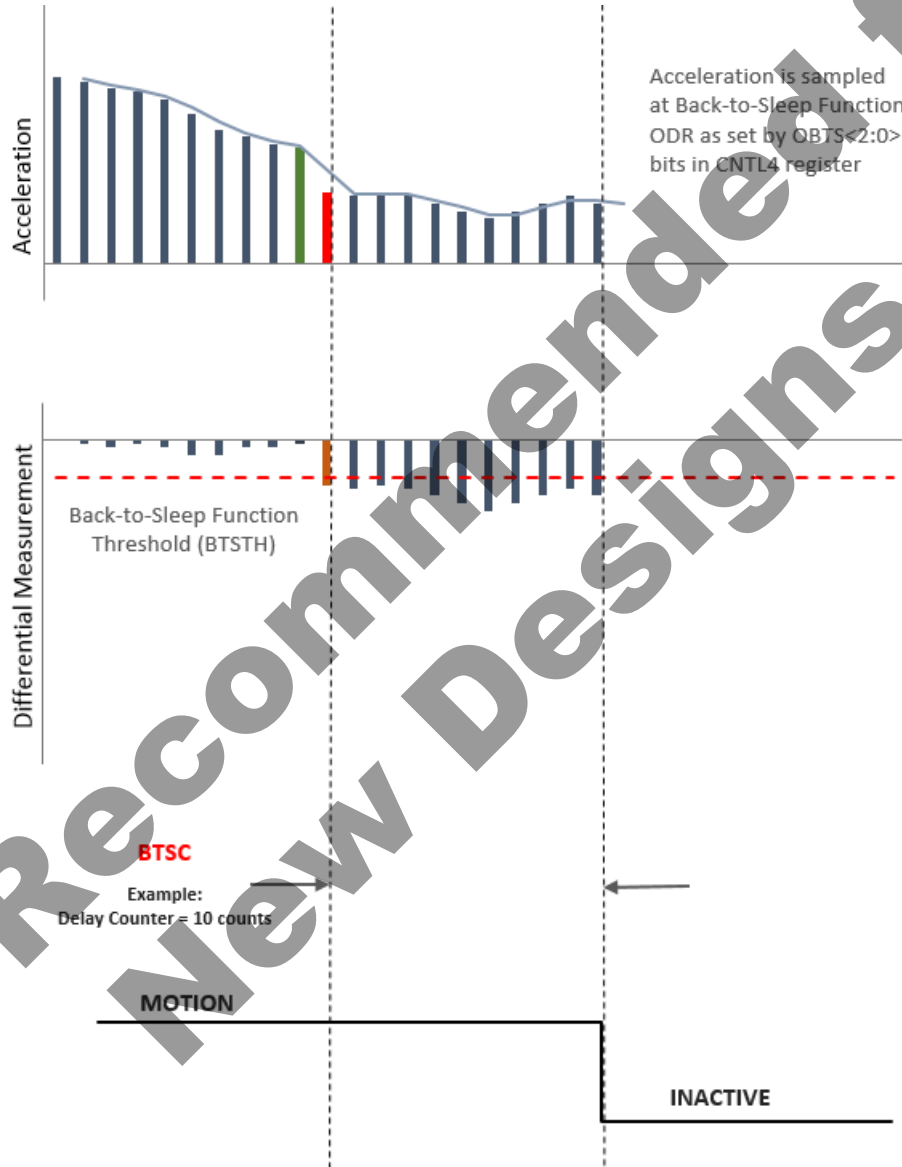

Figure 14: Latched Motion Interrupt Response with BTSC



± 2g / 4g / 8g Tri-axis Digital Accelerometer Specifications

PART NUMBER:
KX127-1068
Rev. 2.0
05-Jun-2019

Directional-Tap Detection Feature Description

The Directional-Tap™ Detection feature of the KX127 recognizes single and double tap inputs and reports the acceleration axis and direction that each tap occurred. Eight performance parameters, as well as a user-selectable ODR are used to configure the KX127 for a desired tap detection response.

Performance Index

The Directional-Tap™ detection algorithm uses low and high thresholds to help determine when a tap event has occurred. A tap event is detected when the previously described jerk summation exceeds the low *threshold (TTL)* for more than the tap detection low limit, but less than the tap detection high limit as contained in FTD. Samples that exceed the high limit (TTH) will be ignored. Figure 15 shows an example of a single tap event meeting the performance index criteria.

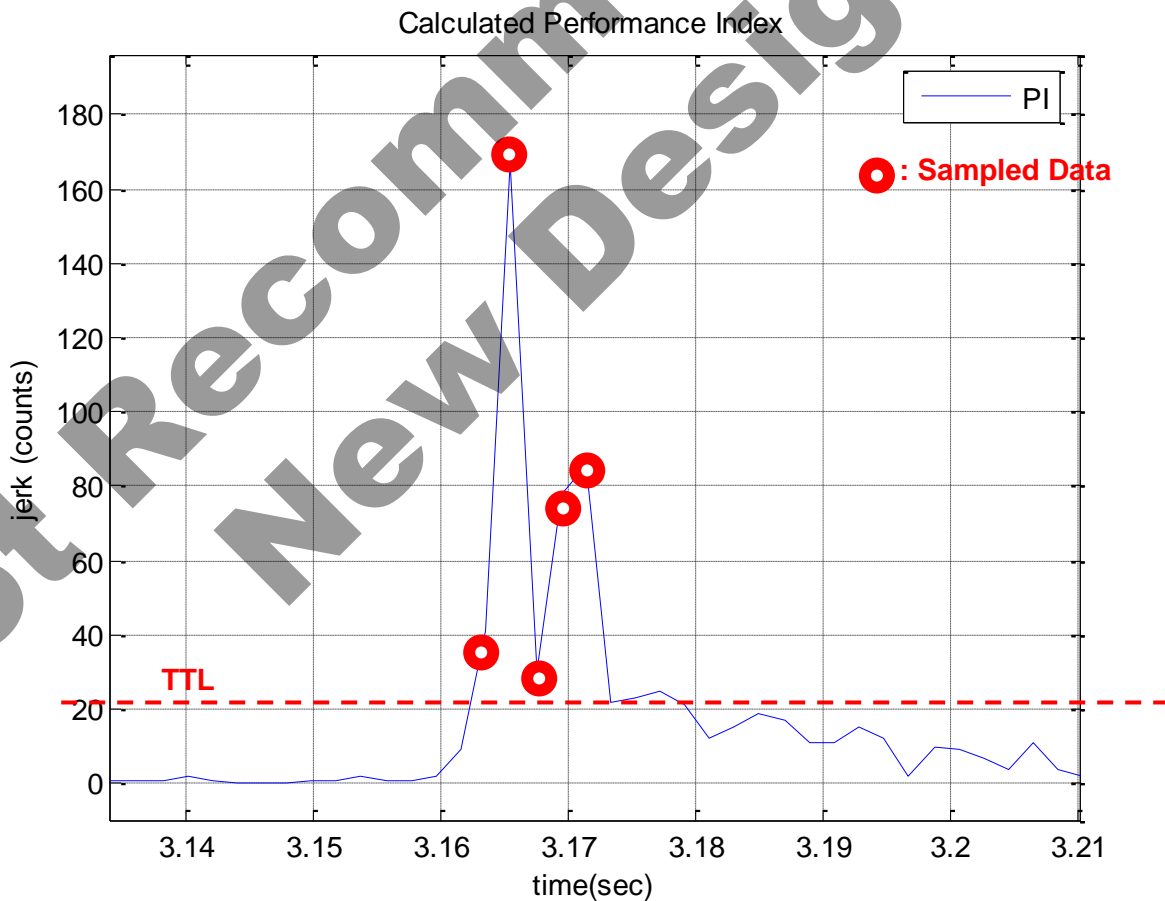

Figure 15: Jerk Summation vs Threshold



± 2g / 4g / 8g Tri-axis Digital Accelerometer Specifications

PART NUMBER:
KX127-1068
Rev. 2.0
05-Jun-2019

Single Tap Detection

The latency timer (TLT) sets the time period that a tap event will only be characterized as a single tap. A second tap has to occur outside of the latency timer. If a second tap occurs inside the latency time, it will be ignored as it occurred too quickly. The single tap will be reported at the end of the TWS. Figure 16 shows a single tap event meeting the PI, latency and window requirements.

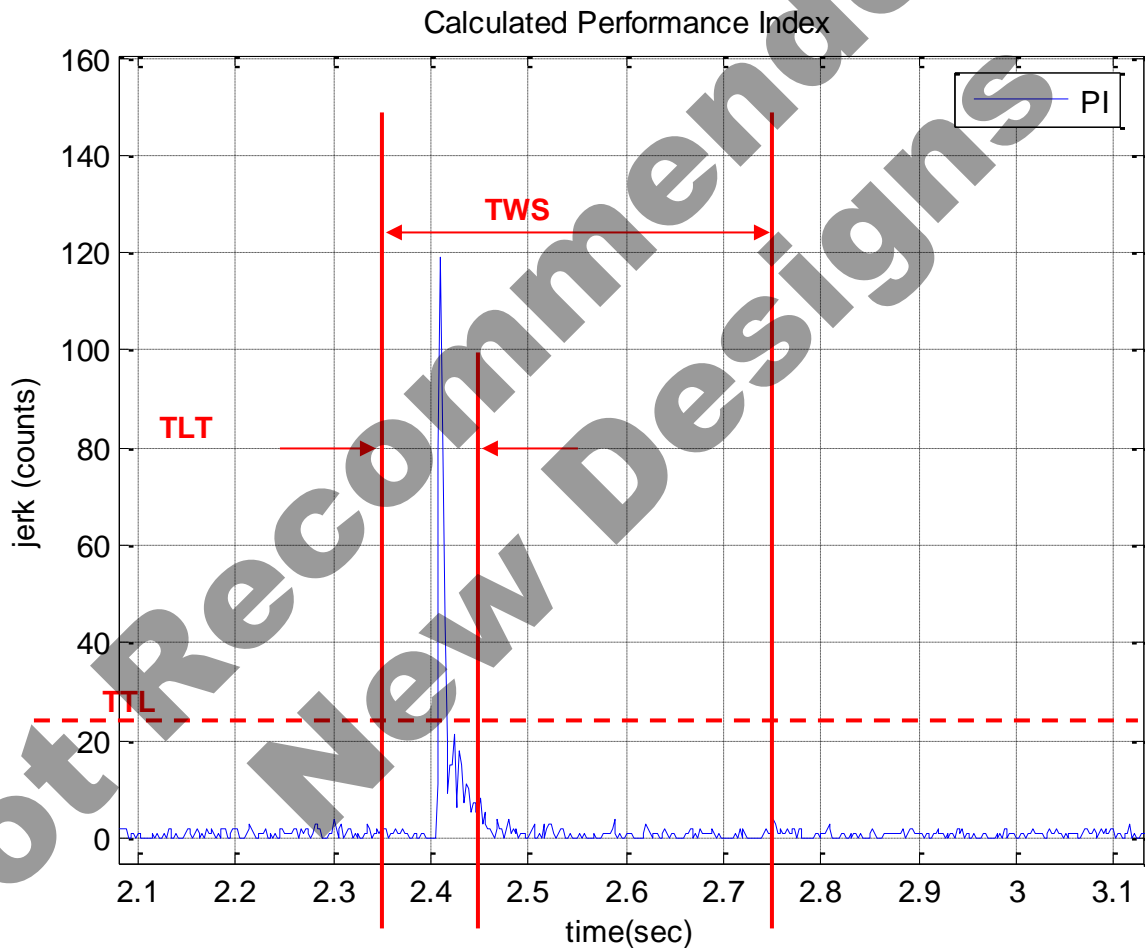

Figure 16: Single Directional-Tap™ Timing



± 2g / 4g / 8g Tri-axis Digital Accelerometer Specifications

PART NUMBER:
KX127-1068
Rev. 2.0
05-Jun-2019

Double-Tap Detection

An event can be characterized as a double tap if the second tap crosses the performance index (TTL) inside the TWS period and ends outside the TDTC. This means that the TDTC determines the minimum time separation that must exist between the two taps of a double tap event. Similar to the single tap, the first tap event must exceed the performance index for the time limit contained in FTD. Also, the duration when the first and second events combined exceed the performance index should not exceed STD. The double tap will be reported at the end of the second TLT. Figure 17 shows a double tap event meeting the PI, latency and window requirements.

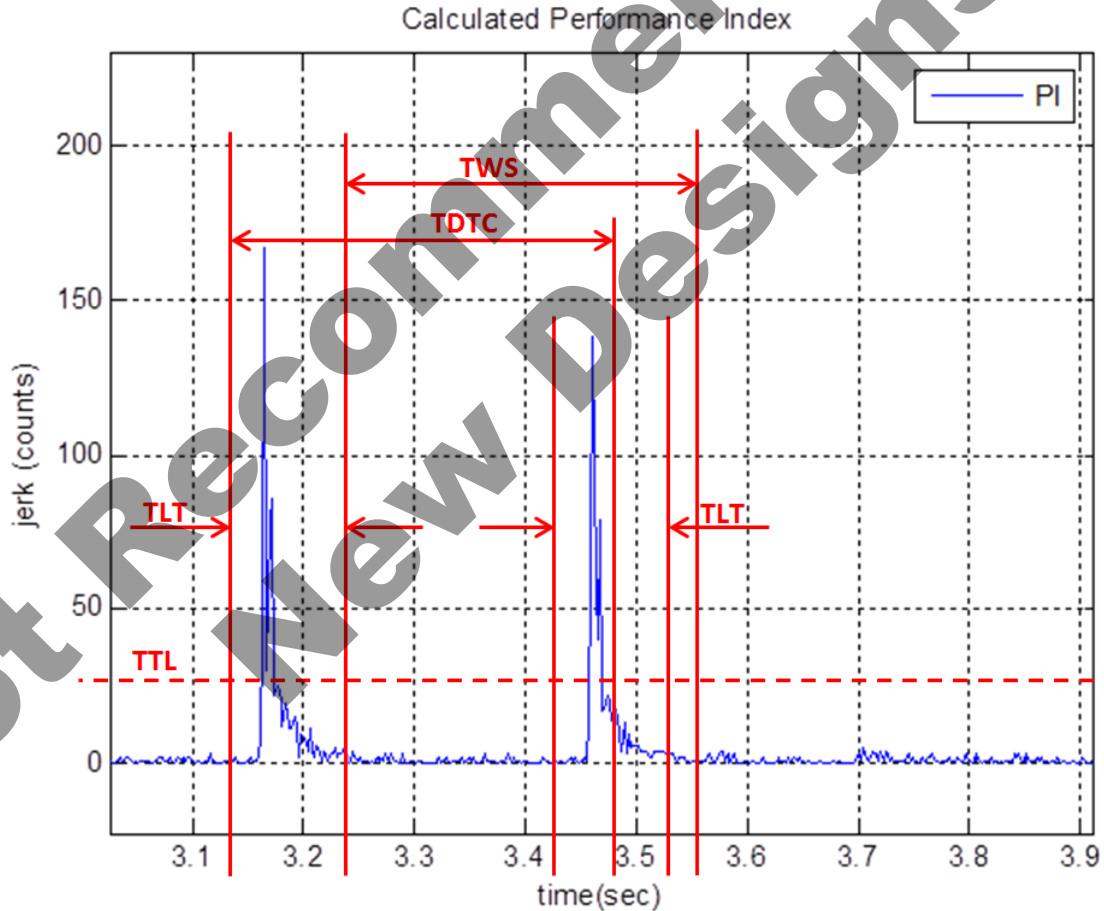

Figure 17: Double-Tap™ Timing



± 2g / 4g / 8g Tri-axis Digital Accelerometer Specifications

PART NUMBER:

KX127-1068

Rev. 2.0

05-Jun-2019

Free fall Detect

The KX127 features a Free fall interrupt that sends a flag through the INT1 or the INT2 output pins when the accelerometer senses a Free fall event. The interrupt event is also reflected on the INT (bit 4) of the STAT and FFS (bit 7) of the INS2 registers. A Free fall event is evident when all three accelerometer axes simultaneously fall below a certain acceleration threshold for a set amount of time. The KX127 gives the user the option to define the acceleration threshold value through the FFTH 8-bit register where 256 counts cover the g range of the accelerometer. This value is compared to the top 8 bits of the accelerometer 8g output value (independent of the actual g-range setting of the device). Equation 8 shows how to calculate the FFTH register value for a desired Free fall threshold. The threshold of 0.5g is a good starting point.

$$\text{FFTH (counts)} = \text{Free fall Threshold (g)} \times 16 \text{ (counts/g)}$$

Equation 8: Free fall Threshold

Through the Free Fall Counter (FFC), the user can set the amount of time all three accelerometer axes must simultaneously remain below the FFTH acceleration threshold before the Free fall interrupt flag is sent through the INT1 or the INT2 output pins. This delay/debounce time is defined by the available 0 to 255 counts, which represent accelerometer samples taken at the Free fall ODR defined by OFFI<2:0> bits in the FFCNTL register. Every count is calculated as 1/ODR delay period. Equation 9 shows how to calculate the FFC register value for a desired Free fall delay. The delay of 0.32 sec is a good starting point.

$$\text{FFC (counts)} = \text{Free fall delay (sec)} \times \text{Free fall ODR (Hz)}$$

Equation 9: Free fall Threshold

When the Free fall interrupt is enabled the part must not be in a physical state that would trigger the Free fall interrupt or the delay will not be correct for the present Free fall.



± 2g / 4g / 8g Tri-axis Digital Accelerometer Specifications

PART NUMBER:
KX127-1068
Rev. 2.0
05-Jun-2019

Typical Freefall Interrupt Example (nonLatching)

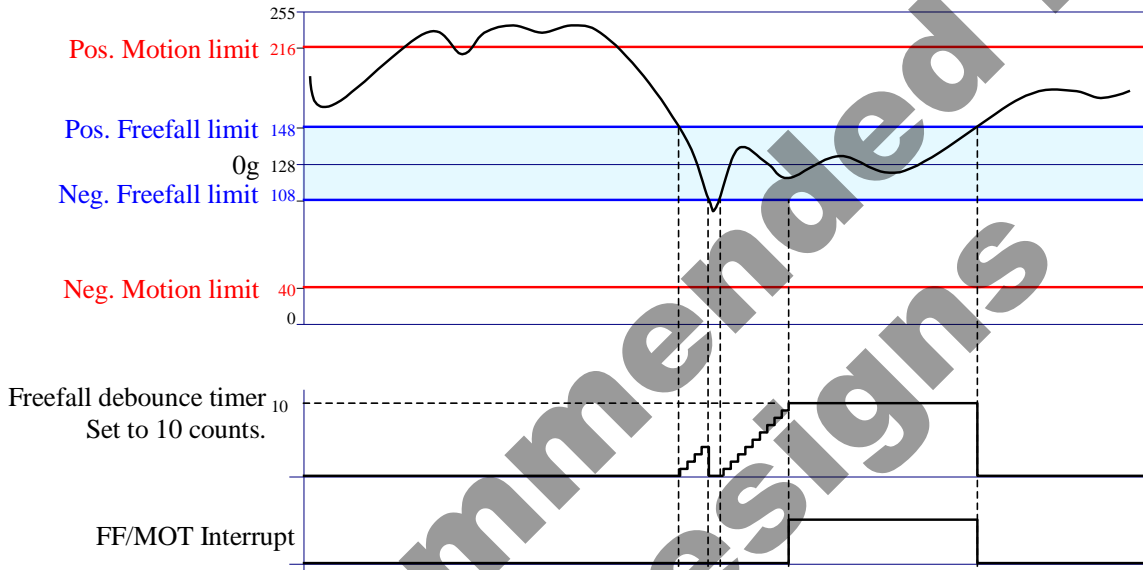

Figure 18: Typical Free fall Interrupt Example (FFCNTL ULMODE = 1)

Typical Freefall Interrupt Example (Latching)

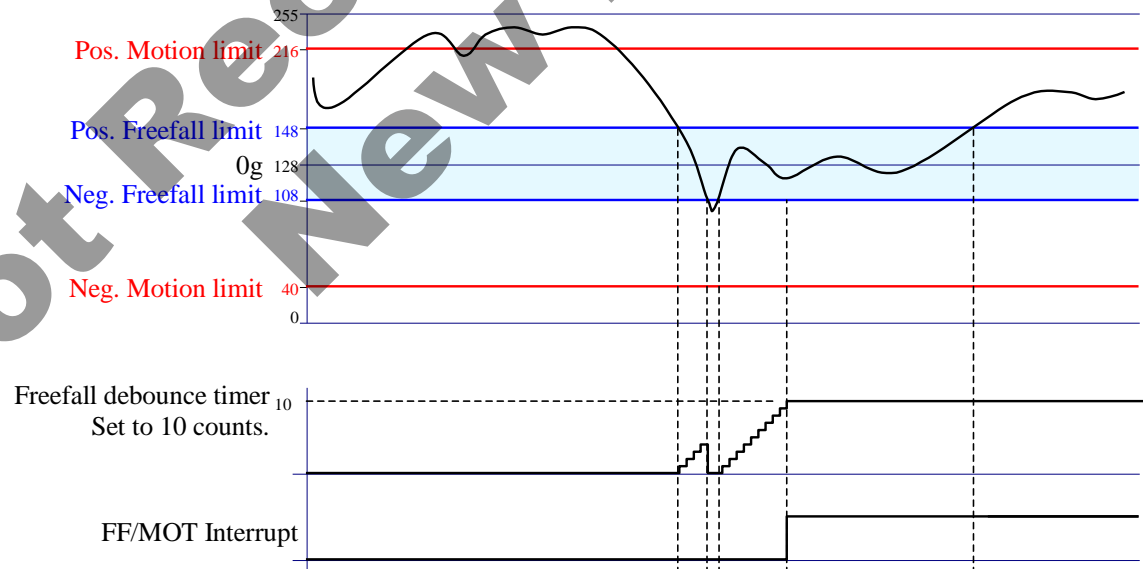

Figure 19: Typical Free fall Interrupt Example (FFCNTL ULMODE = 0)



± 2g / 4g / 8g Tri-axis Digital Accelerometer Specifications

PART NUMBER:
KX127-1068
Rev. 2.0
05-Jun-2019

Sample Buffer Feature Description

The sample buffer feature of the KX127 accumulates and outputs acceleration data based on how it is configured. There are 4 buffer modes available, and samples can be accumulated at either low (8-bit) or high (16-bit) resolution. Acceleration data is collected at the ODR specified by OSA[3:0] in the ODCNTL register. Each buffer mode accumulates data, reports data, and interacts with status indicators in a slightly different way.

FIFO Mode

Data Accumulation

Sample collection stops when the buffer is full.

Data Reporting

Data is reported with the oldest byte of the oldest sample first (X_L or X based on resolution).

Status Indicators

A watermark interrupt occurs when the number of samples in the buffer reaches the Sample Threshold. The watermark interrupt stays active until the buffer contains less than this number of samples. This can be accomplished through clearing the buffer or explicitly reading greater than SMPX samples (calculated with Equation 10).

BUF_RES=0:

$$\text{SMPX} = \text{SMP_LEV}[11:0] / 3 - \text{SMP_TH}[9:0]$$

BUF_RES=1:

$$\text{SMPX} = \text{SMP_LEV}[11:0] / 6 - \text{SMP_TH}[9:0]$$

Equation 10: Samples Above Sample Threshold

Stream Mode

Data Accumulation

Sample collection continues when the buffer is full; older data is discarded to make room for newer data.

Data Reporting

Data is reported with the oldest sample first (uses FIFO read pointer).

Status Indicators

A watermark interrupt occurs when the number of samples in the buffer reaches the Sample Threshold. The watermark interrupt stays active until the buffer contains less than this number of samples. This can be accomplished through clearing the buffer or explicitly reading greater than SMPX samples (calculated with Equation 10).



± 2g / 4g / 8g Tri-axis Digital Accelerometer Specifications

PART NUMBER:
KX127-1068
Rev. 2.0
05-Jun-2019

Trigger Mode

Data Accumulation

When a physical interrupt is caused by one of the digital engines or when a logic high signal occurs on the TRIG pin, the trigger event is asserted and SMP_TH[9:0] samples prior to the event are retained. Sample collection continues until the buffer is full.

Data Reporting

Data is reported with the oldest sample first (uses FIFO read pointer).

Status Indicators

When a physical interrupt occurs and there are at least SMP_TH[9:0] samples in the buffer, BUF_TRIG in BUF_STATUS_2 is asserted.

FIFO Mode

Data Accumulation

Sample collection continues when the buffer is full; older data is discarded to make room for newer data.

Data Reporting

Data is reported with the newest byte of the newest sample first (Z_H or Z based on resolution).

Status Indicators

A watermark interrupt occurs when the number of samples in the buffer reaches the Sample Threshold. The watermark interrupt stays active until the buffer contains less than this number of samples. This can be accomplished through clearing the buffer or explicitly reading greater than SMPX samples (calculated with Equation 10).

Buffer Operation

The following diagrams illustrate the operation of the buffer conceptually. Actual physical implementation has been abstracted to offer a simplified explanation of how the different buffer modes operate. Figure 20 represents a high-resolution 3-axis sample within the buffer. Figure 21 – Figure 29 represent a 10-sample version of the buffer (for simplicity), with Sample Threshold set to 8.

Regardless of the selected mode, the buffer fills sequentially, one byte at a time. Figure 20 shows one 6-byte data sample. Note the location of the FILO read pointer versus that of the FIFO read pointer.



± 2g / 4g / 8g Tri-axis Digital Accelerometer Specifications

PART NUMBER:
KX127-1068
Rev. 2.0
05-Jun-2019

Index	Byte	
0	X_L	←-- FIFO read pointer
1	X_H	
2	Y_L	
3	Y_H	
4	Z_L	
5	Z_H	←-- FILO read pointer
6		

buffer write pointer -->

Figure 20: One Buffer Sample

Regardless of the selected mode, the buffer fills sequentially, one sample at a time. Note in Figure 21 the location of the FILO read pointer versus that of the FIFO read pointer. The buffer write pointer shows where the next sample will be written to the buffer.

Index	Sample	
0	Data0	← FIFO read pointer
1	Data1	
2	Data2	← FILO read pointer
3		
4		
5		
6		
7		← Sample Threshold
8		
9		

buffer write pointer →

Figure 21: Buffer Filling



± 2g / 4g / 8g Tri-axis Digital Accelerometer Specifications

PART NUMBER:
KX127-1068
Rev. 2.0
05-Jun-2019

The buffer continues to fill sequentially until the Sample Threshold is reached. Note in Figure 22 the location of the FILO read pointer versus that of the FIFO read pointer.

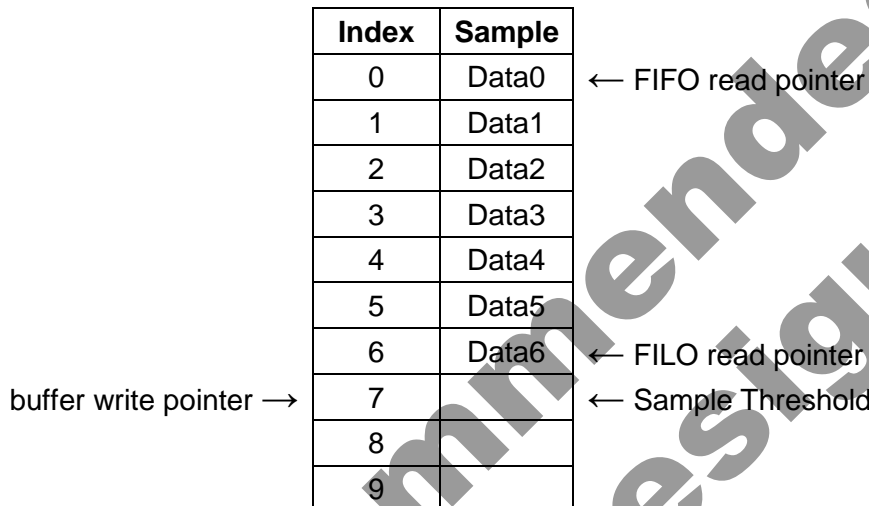

Figure 22: Buffer Approaching Sample Threshold

In FIFO, Stream, and FILO modes, a watermark interrupt is issued when the number of samples in the buffer reaches the Sample Threshold. In trigger mode, this is the point where the oldest data in the buffer is discarded to make room for newer data.

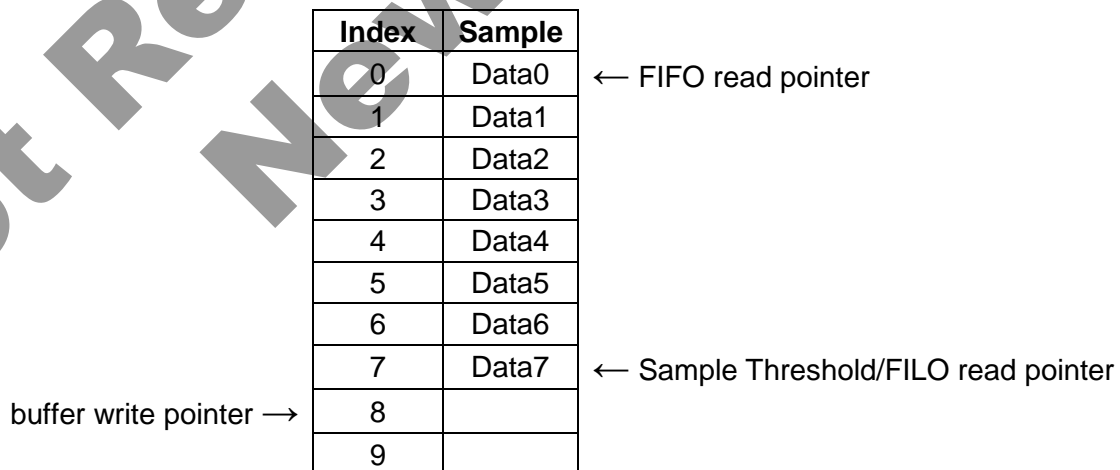

Figure 23: Buffer at Sample Threshold



± 2g / 4g / 8g Tri-axis Digital Accelerometer Specifications

PART NUMBER:
KX127-1068
Rev. 2.0
05-Jun-2019

In trigger mode, data is accumulated in the buffer sequentially until the Sample Threshold is reached. Once the Sample Threshold is reached, the oldest samples are discarded when new samples are collected. Note in Figure 24 how Data0 was thrown out to make room for Data8.

Index	Sample	
0	Data1	← Trigger read pointer
1	Data2	
2	Data3	
3	Data4	
4	Data5	
5	Data6	
6	Data7	
7	Data8	← Sample Threshold
8		
9		

Trigger write pointer →

Figure 24: Additional Data Prior to Trigger Event

After a trigger event occurs, the buffer no longer discards the oldest samples, and instead begins accumulating samples sequentially until full. The buffer then stops collecting samples, as seen in Figure 25. This results in the buffer holding SMP_TH[9:0] samples prior to the trigger event, and SMPX samples after the trigger event.

Index	Sample	
0	Data1	← Trigger read pointer
1	Data2	
2	Data3	
3	Data4	
4	Data5	
5	Data6	
6	Data7	
7	Data8	← Sample Threshold
8	Data9	
9	Data10	

Figure 25: Additional Data after Trigger Event



± 2g / 4g / 8g Tri-axis Digital Accelerometer Specifications

PART NUMBER:
KX127-1068
Rev. 2.0
05-Jun-2019

In FIFO, Stream, FILO, and Trigger (after a trigger event has occurred) modes, the buffer continues filling sequentially after the Sample Threshold is reached. Sample accumulation after the buffer is full depends on the selected operation mode. FIFO and Trigger modes stop accumulating samples when the buffer is full, and Stream and FILO modes begin discarding the oldest data when new samples are accumulated.

Index	Sample	
0	Data0	← FIFO read pointer
1	Data1	
2	Data2	
3	Data3	
4	Data4	
5	Data5	
6	Data6	
7	Data7	← Sample Threshold
8	Data8	
9	Data9	← FILO read pointer

Figure 26: Buffer Full

After the buffer has been filled in FILO or Stream mode, the oldest samples are discarded when new samples are collected. Note in Figure 27 how Data0 was thrown out to make room for Data10.

Index	Sample	
0	Data1	← FIFO read pointer
1	Data2	
2	Data3	
3	Data4	
4	Data5	
5	Data6	
6	Data7	
7	Data8	← Sample Threshold
8	Data9	
9	Data10	← FILO read pointer

Figure 27: Buffer Full – Additional Sample Accumulation in Stream or FILO Mode



± 2g / 4g / 8g Tri-axis Digital Accelerometer Specifications

PART NUMBER:
KX127-1068
Rev. 2.0
05-Jun-2019

In FIFO, Stream, or Trigger mode, reading one sample from the buffer will remove the oldest sample and effectively shift the entire buffer contents up, as seen in Figure 28.

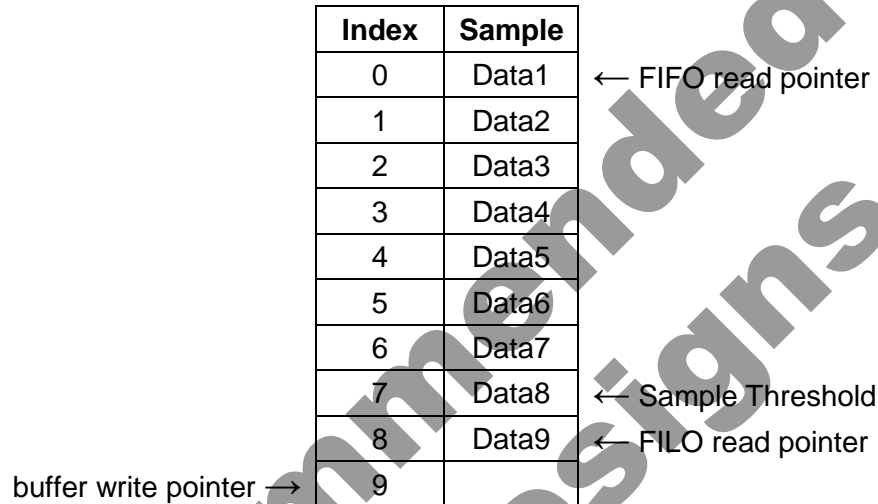

Figure 28: FIFO Read from Full Buffer

In FILO mode, reading one sample from the buffer will remove the newest sample and leave the older samples untouched, as seen in Figure 29.

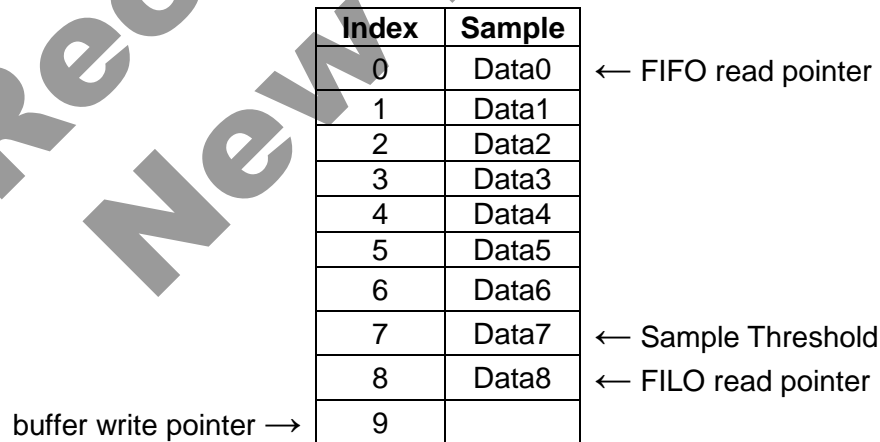



Figure 29: FILO Read from Full Buffer

	± 2g / 4g / 8g Tri-axis Digital Accelerometer Specifications	PART NUMBER: KX127-1068 Rev. 2.0 05-Jun-2019
---	---	--

Pedometer (Step Counter) Feature

Please refer to Application Note [AN073 Getting Started with Pedometer](#) for more information.

Not Recommended for New Designs

	± 2g / 4g / 8g Tri-axis Digital Accelerometer Specifications	PART NUMBER: KX127-1068 Rev. 2.0 05-Jun-2019
---	---	---

Revision History

Revision	Description	Date
1.0	Initial Release	23-Feb-2018
2.0	Fixed bits descriptions in INC2, INC3 registers. Fixed description of ACLR1 and ACLR2 bits in INC5 register. In PED_CNTL 1-10 registers, indicated that PDE bit in CNTL1 should also be set to 0 in addition to PC1 bit. Updated Self-test register description to provide more information on how to enable, disable, and evaluate the self-test. Changed name to Mechanical Signal Bandwidth and added note to describe the test condition. Fixed Mechanical Signal Bandwidth -3dB values. Changed parameter name to Output Signal Bandwidth in Electrical Specification Table. Added WHO_AM_I value to Electrical Specifications table. Updated Package Outline Drawing. Updated Current Profile plot, Startup Profile plot, and OSA bits description to indicate that 400Hz ODR is supported in Low Power mode. Updated Environmental section. Fixed ASIC interface section.	05-Jun-2019

"Kionix" is a registered trademark of Kionix, Inc. Products described herein are protected by patents issued or pending. No license is granted by implication or otherwise under any patent or other rights of Kionix. The information contained herein is believed to be accurate and reliable but is not guaranteed. Kionix does not assume responsibility for its use or distribution. Kionix also reserves the right to change product specifications or discontinue this product at any time without prior notice. This publication supersedes and replaces all information previously supplied.

	± 2g / 4g / 8g Tri-axis Digital Accelerometer Specifications	PART NUMBER: KX127-1068 Rev. 2.0 05-Jun-2019
---	---	---

Appendix

The following Notice is included to guide the use of Kionix products in its application and manufacturing processes. Kionix, Inc., is a ROHM Group company. For purposes of this Notice, the name "ROHM" would also imply Kionix, Inc.

Not Recommended for New Designs

Notice

Precaution on using ROHM Products

- Our Products are designed and manufactured for application in ordinary electronic equipment (such as AV equipment, OA equipment, telecommunication equipment, home electronic appliances, amusement equipment, etc.). If you intend to use our Products in devices requiring extremely high reliability (such as medical equipment ^(Note 1), transport equipment, traffic equipment, aircraft/spacecraft, nuclear power controllers, fuel controllers, car equipment including car accessories, safety devices, etc.) and whose malfunction or failure may cause loss of human life, bodily injury or serious damage to property ("Specific Applications"), please consult with the ROHM sales representative in advance. Unless otherwise agreed in writing by ROHM in advance, ROHM shall not be in any way responsible or liable for any damages, expenses or losses incurred by you or third parties arising from the use of any ROHM's Products for Specific Applications.

(Note1) Medical Equipment Classification of the Specific Applications

JAPAN	USA	EU	CHINA
CLASS III	CLASS III	CLASS II b	CLASS III
CLASS IV		CLASS III	

- ROHM designs and manufactures its Products subject to strict quality control system. However, semiconductor products can fail or malfunction at a certain rate. Please be sure to implement, at your own responsibilities, adequate safety measures including but not limited to fail-safe design against the physical injury, damage to any property, which a failure or malfunction of our Products may cause. The following are examples of safety measures:
 - Installation of protection circuits or other protective devices to improve system safety
 - Installation of redundant circuits to reduce the impact of single or multiple circuit failure
- Our Products are designed and manufactured for use under standard conditions and not under any special or extraordinary environments or conditions, as exemplified below. Accordingly, ROHM shall not be in any way responsible or liable for any damages, expenses or losses arising from the use of any ROHM's Products under any special or extraordinary environments or conditions. If you intend to use our Products under any special or extraordinary environments or conditions (as exemplified below), your independent verification and confirmation of product performance, reliability, etc. prior to use, must be necessary:
 - Use of our Products in any types of liquid, including water, oils, chemicals, and organic solvents
 - Use of our Products outdoors or in places where the Products are exposed to direct sunlight or dust
 - Use of our Products in places where the Products are exposed to sea wind or corrosive gases, including Cl₂, H₂S, NH₃, SO₂, and NO₂
 - Use of our Products in places where the Products are exposed to static electricity or electromagnetic waves
 - Use of our Products in proximity to heat-producing components, plastic cords, or other flammable items
 - Sealing or coating our Products with resin or other coating materials
 - Use of our Products without cleaning residue of flux (Exclude cases where no-clean type fluxes is used. However, recommend sufficiently about the residue.) ; or Washing our Products by using water or water-soluble cleaning agents for cleaning residue after soldering
 - Use of the Products in places subject to dew condensation
- The Products are not subject to radiation-proof design.
- Please verify and confirm characteristics of the final or mounted products in using the Products.
- In particular, if a transient load (a large amount of load applied in a short period of time, such as pulse. is applied, confirmation of performance characteristics after on-board mounting is strongly recommended. Avoid applying power exceeding normal rated power; exceeding the power rating under steady-state loading condition may negatively affect product performance and reliability.
- De-rate Power Dissipation depending on ambient temperature. When used in sealed area, confirm that it is the use in the range that does not exceed the maximum junction temperature.
- Confirm that operation temperature is within the specified range described in the product specification.
- ROHM shall not be in any way responsible or liable for failure induced under deviant condition from what is defined in this document.

Precaution for Mounting / Circuit board design

- When a highly active halogenous (chlorine, bromine, etc.) flux is used, the residue of flux may negatively affect product performance and reliability.
- In principle, the reflow soldering method must be used on a surface-mount products, the flow soldering method must be used on a through hole mount products. If the flow soldering method is preferred on a surface-mount products, please consult with the ROHM representative in advance.

For details, please refer to ROHM Mounting specification

Precautions Regarding Application Examples and External Circuits

1. If change is made to the constant of an external circuit, please allow a sufficient margin considering variations of the characteristics of the Products and external components, including transient characteristics, as well as static characteristics.
2. You agree that application notes, reference designs, and associated data and information contained in this document are presented only as guidance for Products use. Therefore, in case you use such information, you are solely responsible for it and you must exercise your own independent verification and judgment in the use of such information contained in this document. ROHM shall not be in any way responsible or liable for any damages, expenses or losses incurred by you or third parties arising from the use of such information.

Precaution for Electrostatic

This Product is electrostatic sensitive product, which may be damaged due to electrostatic discharge. Please take proper caution in your manufacturing process and storage so that voltage exceeding the Products maximum rating will not be applied to Products. Please take special care under dry condition (e.g. Grounding of human body / equipment / solder iron, isolation from charged objects, setting of Ionizer, friction prevention and temperature / humidity control).

Precaution for Storage / Transportation

1. Product performance and soldered connections may deteriorate if the Products are stored in the places where:
 - [a] the Products are exposed to sea winds or corrosive gases, including Cl₂, H₂S, NH₃, SO₂, and NO₂
 - [b] the temperature or humidity exceeds those recommended by ROHM
 - [c] the Products are exposed to direct sunshine or condensation
 - [d] the Products are exposed to high Electrostatic
2. Even under ROHM recommended storage condition, solderability of products out of recommended storage time period may be degraded. It is strongly recommended to confirm solderability before using Products of which storage time is exceeding the recommended storage time period.
3. Store / transport cartons in the correct direction, which is indicated on a carton with a symbol. Otherwise bent leads may occur due to excessive stress applied when dropping of a carton.
4. Use Products within the specified time after opening a humidity barrier bag. Baking is required before using Products of which storage time is exceeding the recommended storage time period.

Precaution for Product Label

A two-dimensional barcode printed on ROHM Products label is for ROHM's internal use only.

Precaution for Disposition

When disposing Products please dispose them properly using an authorized industry waste company.

Precaution for Foreign Exchange and Foreign Trade act

Since concerned goods might be fallen under listed items of export control prescribed by Foreign exchange and Foreign trade act, please consult with ROHM in case of export.

Precaution Regarding Intellectual Property Rights

1. All information and data including but not limited to application example contained in this document is for reference only. ROHM does not warrant that foregoing information or data will not infringe any intellectual property rights or any other rights of any third party regarding such information or data.
2. ROHM shall not have any obligations where the claims, actions or demands arising from the combination of the Products with other articles such as components, circuits, systems or external equipment (including software).
3. No license, expressly or implied, is granted hereby under any intellectual property rights or other rights of ROHM or any third parties with respect to the Products or the information contained in this document. Provided, however, that ROHM will not assert its intellectual property rights or other rights against you or your customers to the extent necessary to manufacture or sell products containing the Products, subject to the terms and conditions herein.

Other Precaution

1. This document may not be reprinted or reproduced, in whole or in part, without prior written consent of ROHM.
2. The Products may not be disassembled, converted, modified, reproduced or otherwise changed without prior written consent of ROHM.
3. In no event shall you use in any way whatsoever the Products and the related technical information contained in the Products or this document for any military purposes, including but not limited to, the development of mass-destruction weapons.
4. The proper names of companies or products described in this document are trademarks or registered trademarks of ROHM, its affiliated companies or third parties.