



# IME18-05BPSZC0K

IME

INDUCTIVE PROXIMITY SENSORS

**SICK**  
Sensor Intelligence.



### Ordering information

Type	Part no.
IME18-05BPSZC0K	1040933

**Included in delivery:** BEF-MU-M18 (1)

Other models and accessories → [www.sick.com/IME](http://www.sick.com/IME)



### Detailed technical data

#### Features

<b>Housing</b>	Cylindrical thread design
<b>Housing</b>	Short-body
<b>Thread size</b>	M18 x 1
<b>Diameter</b>	Ø 18 mm
<b>Sensing range <math>S_n</math></b>	5 mm
<b>Safe sensing range <math>S_a</math></b>	4.05 mm
<b>Installation type</b>	Flush
<b>Switching frequency</b>	1,000 Hz
<b>Connection type</b>	Male connector M12, 4-pin
<b>Switching output</b>	PNP
<b>Output function</b>	NO
<b>Electrical wiring</b>	DC 3-wire
<b>Enclosure rating</b>	IP67 <sup>1)</sup>

<sup>1)</sup> According to EN 60529.

#### Mechanics/electronics

<b>Supply voltage</b>	10 V DC ... 30 V DC
<b>Ripple</b>	≤ 10 %
<b>Voltage drop</b>	≤ 2 V <sup>1)</sup>
<b>Current consumption</b>	10 mA <sup>2)</sup>
<b>Time delay before availability</b>	≤ 100 ms
<b>Hysteresis</b>	5 % ... 15 %

<sup>1)</sup> At  $I_a$  max.

<sup>2)</sup> Without load.

<sup>3)</sup>  $U_b$  and  $T_a$  constant.

<sup>4)</sup> Of  $S_r$ .

<b>Reproducibility</b>	≤ 2 % <sup>3) 4)</sup>
<b>Temperature drift (of S<sub>r</sub>)</b>	± 10 %
<b>EMC</b>	According to EN 60947-5-2
<b>Continuous current I<sub>a</sub></b>	≤ 200 mA
<b>Short-circuit protection</b>	✓
<b>Reverse polarity protection</b>	✓
<b>Power-up pulse protection</b>	✓
<b>Shock and vibration resistance</b>	30 g, 11 ms/10 Hz ... 55 Hz, 1 mm
<b>Ambient operating temperature</b>	-25 °C ... +75 °C
<b>Housing material</b>	Metal, Nickel-plated brass
<b>Sensing face material</b>	Plastic, PA 66
<b>Housing length</b>	50 mm
<b>Thread length</b>	33 mm
<b>Tightening torque, max.</b>	≤ 40 Nm
<b>Items supplied</b>	Mounting nut, brass, nickel-plated (2x)
<b>UL File No.</b>	NRKH.E181493

1) At I<sub>a</sub> max.

2) Without load.

3) U<sub>b</sub> and T<sub>a</sub> constant.

4) Of S<sub>r</sub>.

### Reduction factors

<b>Note</b>	The values are reference values which may vary
<b>St37 steel (Fe)</b>	1
<b>Stainless steel (V2A, 304)</b>	Approx. 0.8
<b>Aluminum (Al)</b>	Approx. 0.45
<b>Copper (Cu)</b>	Approx. 0.4
<b>Brass (Br)</b>	Approx. 0.4

### Installation note

<b>Remark</b>	Associated graphic see "Installation"
<b>B</b>	18 mm
<b>C</b>	18 mm
<b>D</b>	15 mm
<b>F</b>	40 mm

### Classifications

<b>ECl@ss 5.0</b>	27270101
<b>ECl@ss 5.1.4</b>	27270101
<b>ECl@ss 6.0</b>	27270101
<b>ECl@ss 6.2</b>	27270101
<b>ECl@ss 7.0</b>	27270101
<b>ECl@ss 8.0</b>	27270101
<b>ECl@ss 8.1</b>	27270101

<b>ECl@ss 9.0</b>	27270101
<b>ETIM 5.0</b>	EC002714
<b>ETIM 6.0</b>	EC002714
<b>UNSPSC 16.0901</b>	39122230

### Installation note

Flush installation

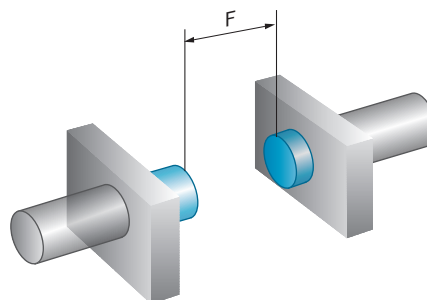
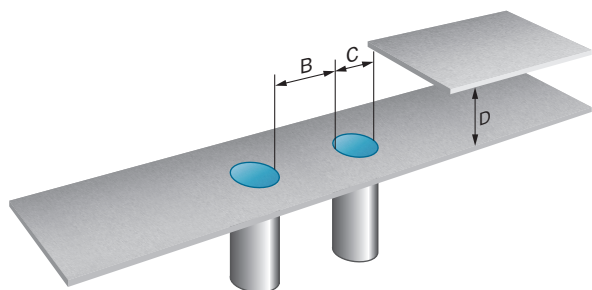

### Connection diagram

Cd-007

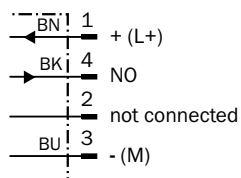

### Dimensional drawing (Dimensions in mm (inch))



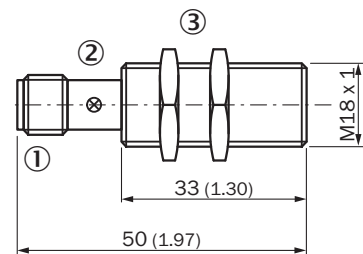



IME18 Short-body housing, connector, flush



- ① Connection
- ② Indication LED
- ③ Fastening nuts (2x); width across 24, metal

## Recommended accessories

Other models and accessories → [www.sick.com/IME](http://www.sick.com/IME)

	Brief description	Type	Part no.
<b>Mounting brackets and plates</b>			
	Mounting plate for M18 sensors, steel, zinc coated, without mounting hardware	BEF-WG-M18	5321870
	Mounting bracket for M18 sensors, steel, zinc coated, without mounting hardware	BEF-WN-M18	5308446
<b>Terminal and alignment brackets</b>			
	Clamping block for round sensors M18, without fixed stop, plastic (PA12), glass-fiber reinforced, mounting hardware included	BEF-KH-M18	2051481
	Clamping block for round sensors M18, with fixed stop, plastic (PA12), glass-fiber reinforced, mounting hardware included	BEF-KHF-M18	2051482
<b>Plug connectors and cables</b>			
	Head A: female connector, M12, 4-pin, straight, A-coded Head B: Flying leads Cable: Sensor/actuator cable, PVC, unshielded, 2 m	YF2A14-020VB3XLEAX	2096234
	Head A: female connector, M12, 4-pin, straight, A-coded Head B: Flying leads Cable: Sensor/actuator cable, PVC, unshielded, 5 m	YF2A14-050VB3XLEAX	2096235
	Head A: female connector, M12, 4-pin, straight, A-coded Head B: Flying leads Cable: Sensor/actuator cable, PVC, unshielded, 10 m	YF2A14-100VB3XLEAX	2096236
	Head A: female connector, M12, 4-pin, angled, A-coded Head B: Flying leads Cable: Sensor/actuator cable, PVC, unshielded, 2 m	YG2A14-020VB3XLEAX	2095895
	Head A: female connector, M12, 4-pin, angled, A-coded Head B: Flying leads Cable: Sensor/actuator cable, PVC, unshielded, 5 m	YG2A14-050VB3XLEAX	2095897
	Head A: female connector, M12, 4-pin, angled, A-coded Head B: Flying leads Cable: Sensor/actuator cable, PVC, unshielded, 10 m	YG2A14-100VB3XLEAX	2095898
	Head A: female connector, M12, 4-pin, straight Head B: - Cable: unshielded	DOS-1204-G	6007302
	Head A: female connector, M12, 4-pin, angled Head B: - Cable: unshielded	DOS-1204-W	6007303

## SICK AT A GLANCE

SICK is one of the leading manufacturers of intelligent sensors and sensor solutions for industrial applications. A unique range of products and services creates the perfect basis for controlling processes securely and efficiently, protecting individuals from accidents and preventing damage to the environment.

We have extensive experience in a wide range of industries and understand their processes and requirements. With intelligent sensors, we can deliver exactly what our customers need. In application centers in Europe, Asia and North America, system solutions are tested and optimized in accordance with customer specifications. All this makes us a reliable supplier and development partner.

Comprehensive services complete our offering: SICK LifeTime Services provide support throughout the machine life cycle and ensure safety and productivity.

For us, that is “Sensor Intelligence.”

## WORLDWIDE PRESENCE:

Contacts and other locations –[www.sick.com](http://www.sick.com)