

SUMMARY



Image is for illustrative purpose only

Wires

Low voltage 5

Series 3K
Termination type Female crimp
IP rating 68 when mated
AWG wire size 18.00 - 14.00
Cable Ø 0.00 - 0.00 mm
Status active
Matching parts [FGG.3K.305.CYCC80](#)

Download

[Request a quote](#)
[Catalog](#)

TECHNICAL DETAILS

Mechanics

Shell Style/Model EE*: Fixed receptacle, nut fixing (back panel mounting)
Keying 1 key (alpha=0, plug: male contacts, receptacle: female contacts)
Housing Material Brass (chrome plated [SAE AMS 2460]) shell, collet nut and latch sleeve, nickel plated [SAE AMS QQ N 290] brass mid pieces
Weight 61.92 g

Performance

Configuration 3K.305 : 5 Low Voltage
Insulator Y: PEEK for crimp contacts
Rated Current 19 Amps

Specifications

Contact Type: Crimp
Contact Retention: 50 N
Contact Dia.: 1.6 mm (0.063in)
Bucket Dia.: 1.9 mm (0.075in)
Min. Conductor: 1 mm² (AWG 18)
Max. Conductor: 1.5 mm² (AWG 14)
R (max): 3.5 mOhm
Vtest (contact-shell): 1750 V (AC), 2500 V (DC)

LEMO products and services are provided "as is". LEMO makes no warranties or representations with regard to LEMO product & services or use of them, express, implied or statutory, including for accuracy, completeness, or security. The user is fully responsible for his products and applications using LEMO components.

Vtest (contact-contact): 2400 V (AC), 3390 V (DC)

Others

Endurance (Shell): 5000 mating cycles
Temp (min / max): -55°C / +200°C
Humidity (max): ≤95% [at 60 deg C / 140 F]
Vibration: 15 g [10 Hz - 2000 Hz]
Shock Resistance: 100 g [6 ms]
Climatical Category: 50/175/21
Shielding (min): 95 dB (10 MHz)
Shielding (min): 80 dB (1 GHz)
Salt Spray Corrosion: >1000 hr

DRAWINGS

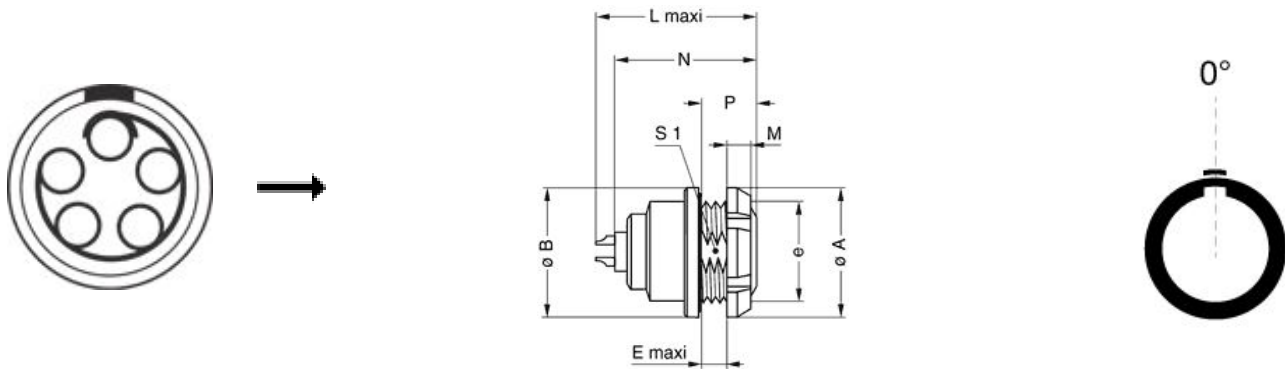

Dimensions

	A	B	E	L	M	N	P	S1	e
mm.	30	31	7.5	36.2	4.5	33.6	12	22.5	M24x1.0
in.	1,18	1,22	0,30	1,43	0,18	1,32	0,47	0,89	















RECOMMENDED BY LEMO

Tools

LEMO products and services are provided "as is". LEMO makes no warranties or representations with regard to LEMO product & services or use of them, express, implied or statutory, including for accuracy, completeness, or security. The user is fully responsible for his products and applications using LEMO components.

Crimp Tool: [DPC.91.101.A](#)
 Crimp settings: AWG/Selector = 14-16-18/7-6-5
 Positionner: [DCE.91.163.BVCM](#)
 Extractor: [DCC.16.25B.LAG](#)
 Replacement contact: EGG.3B.670.ZZM
 Spanner wrench: [Socket for torque wrench DCM.65.200.AZ and DCM.65.270.AZ](#)

Cables

CMN.05.T18.065PGZE		Grey	
CMN.05.T18.065PNZE			
CMN.05.T20.057PGZE		Grey	
CMN.05.T20.057PNZE			
CMN.05.T20.057QGZE	TPR (medical)	Grey	
CMN.05.T22.051QGZE	TPR (medical)	Grey	
CMN.05.T28.029PGCE	PVC	GREY	
CMN.05.T28.029PGZE		Grey	
CMN.05.T28.029PNCE	PVC	Black	
CMN.05.T28.029PNZE			
150250	PVC	Grey	
250500	PVC	Grey	
50090	PVC	Black	
50140	PVC	Grey	
5050	PVC	Black	

LEMO products and services are provided "as is". LEMO makes no warranties or representations with regard to LEMO product & services or use of them, express, implied or statutory, including for accuracy, completeness, or security. The user is fully responsible for his products and applications using LEMO components.