

TOLERANCE UNLESS OTHERWISE SPECIFIED	
.X	±0.25
.XX	±0.13
.XXX	±0.10

THIS IS A C.A.D. GENERATED DRAWING
DO NOT MAKE MANUAL REVISIONS TO MASTER.

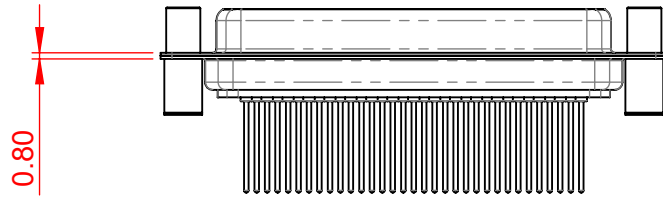

ISSUE NUMBER	
ORIGINAL	①

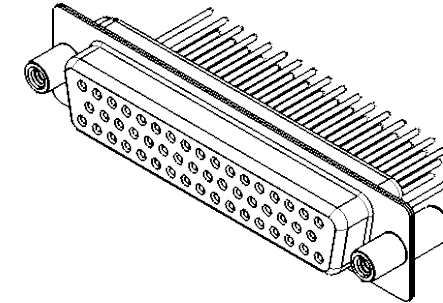
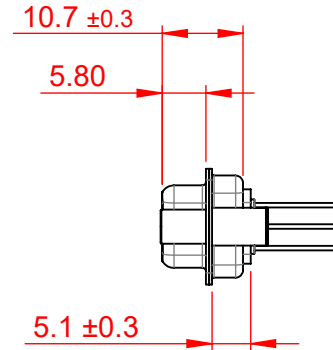
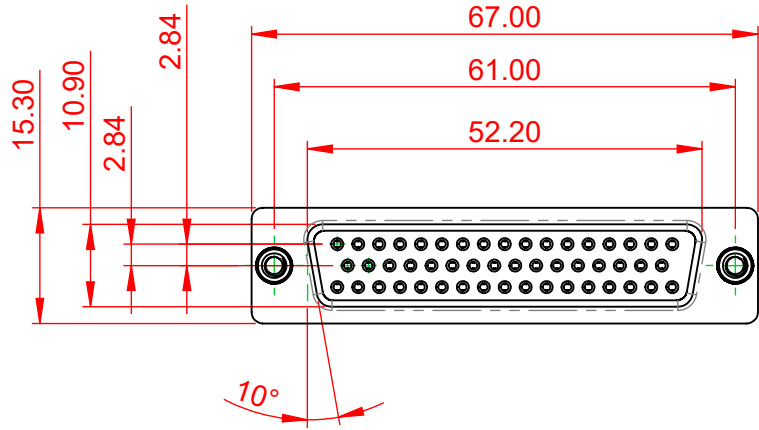

NOTES:

MATERIAL:
HOUSING: BLUE THERMOPLASTIC POLYESTER, UL94V-0
SHELL: STEEL, NICKEL PLATED
CONTACT: COPPER ALLOY, 15µ GOLD PLATED

OPERATING TEMPERATURE: -55°C ~ 125°C

CURRENT RATING: 5A PER CONTACT
CONTACT RESISTANCE: 25mΩ MAX.
INSULATOR RESISTANCE: 5000MΩ min.
DIELECTRIC WITHSTANDING VOLTAGE: 1000V AC rms



THIS SERIES FULLY CONFORMS TO
THE EUROPEAN UNION DIRECTIVES
2011/65/EU FOR RoHS COMPLIANCY.



YOUR CONNECTION TO QUALITY & SERVICE

EDAC INC
TORONTO, ONTARIO
CANADA

THESE DRAWINGS AND SPECIFICATIONS
ARE THE PROPERTY OF EDAC INC., AND
SHALL NOT BE REPRODUCED, OR COPIED
OR USED AS THE BASIS FOR THE
MANUFACTURE OR SALE OF APPARATUS
WITHOUT WRITTEN PERMISSION.

628 SERIES D-SUB CONNECTOR

SW REFERENCE NO.: 628M ASSEMBLY	
DRAWN: C.B	DATE: AUG. 01/2018
CHECKED:	DATE:
SCALE: 1:1	SHEET 1 OF 1
DRAWING NUMBER: 628-M50-323-LN4	ISSUE
PART NUMBER: 628-M50-323-LN4	1