

# NFCS1060L3TT

## 2-in-1 PFC and Inverter Intelligent Power Module (IPM), 600 V, 10 A

The NFCS1060L3TT is a fully-integrated PFC and inverter power stage consisting of a high-voltage driver, six motor drive IGBT's, one PFC SJ-MOSFET, one PFC SiC-SBD for rectifier and a thermistor, suitable for driving permanent magnet synchronous (PMSM) motors, brushless-DC (BLDC) motors and AC asynchronous motors.

The IGBT's are configured in a 3-phase bridge with separate emitter connections for the lower legs for maximum flexibility in the choice of control algorithm.

An internal comparator and reference connected to the over-current protection circuit allows the designer to set individual over-current protection levels for the PFC and the inverter stages. Additionally, the power stage has a full range of protection functions including cross-conduction protection, external shutdown and under-voltage lockout functions.

### Features

- Simple Thermal Design with PFC and Inverter Stage in One Package
- Cross-Conduction Protection
- Integrated Bootstrap Diodes and Resistors
- UL1577 Certification (File Number: E339285)

### Typical Applications

- Heat Pumps
- Home Appliances
- Industrial Fans
- Industrial Pumps

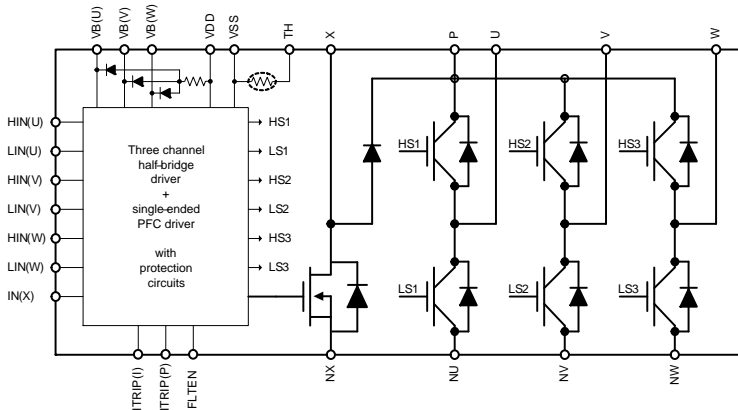
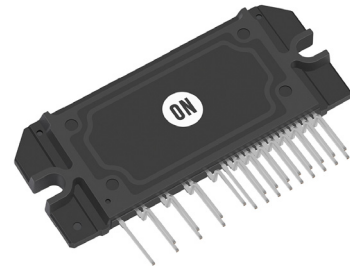

Figure 1. Function Diagram



ON Semiconductor®

[www.onsemi.com](http://www.onsemi.com)



SIP35 56x25.8 / SIP2A-2  
CASE 127DT

### MARKING DIAGRAM



NFCS1060L3TT = Specific Device Code  
 ZZZ = Assembly Lot Code  
 A = Assembly Location  
 T = Test Location  
 Y = Year  
 WW = Work Week  
 Device marking is on package top side

### ORDERING INFORMATION

Device	Package	Shipping (Qty / Packing)
NFCS1060L3TT	SIP35 56x25.8 / SIP2A-2 (Pb-Free)	8 / Tube

# NFCS1060L3TT

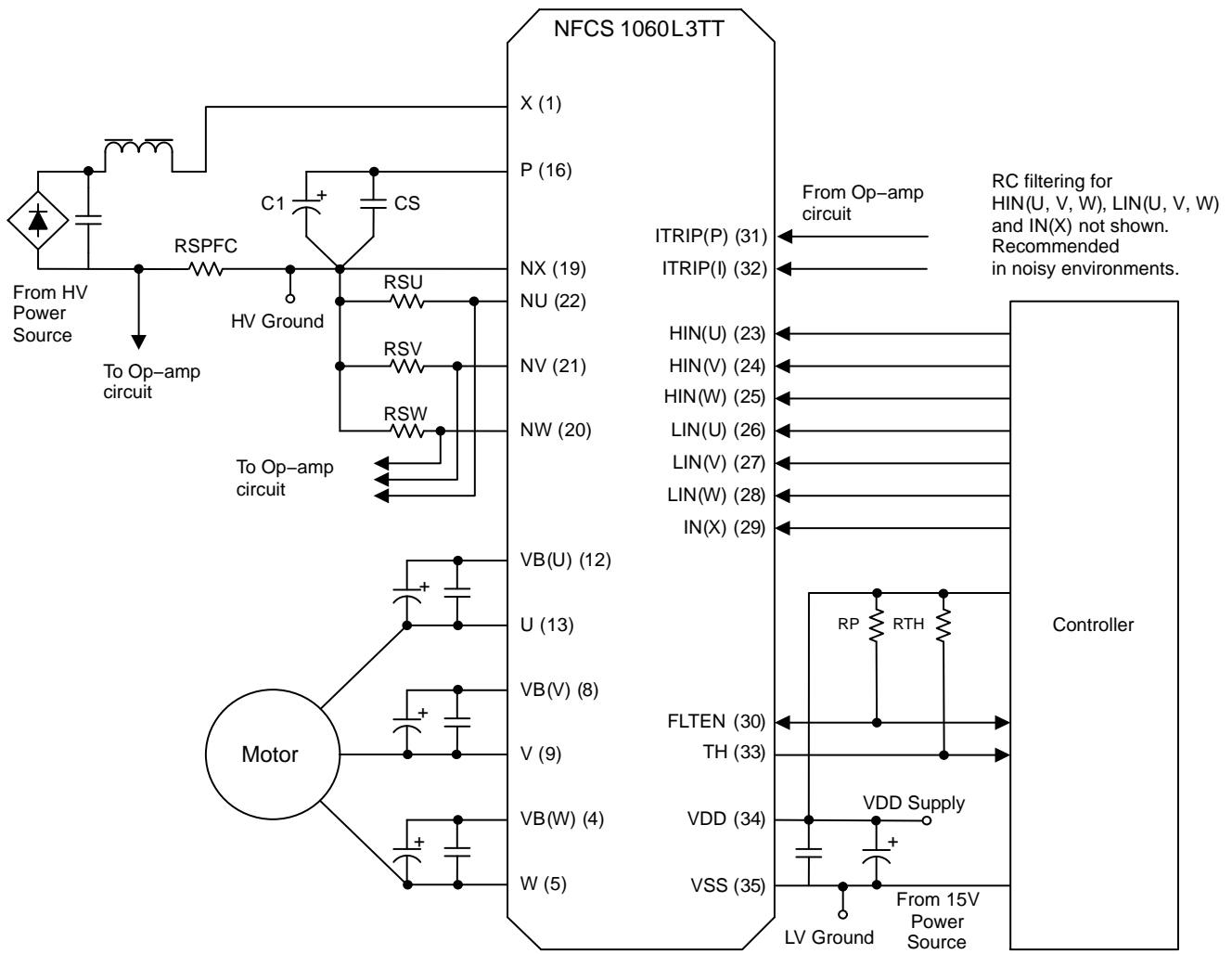

Figure 2. Application Schematic – Adjustable Option

# NFCS1060L3TT

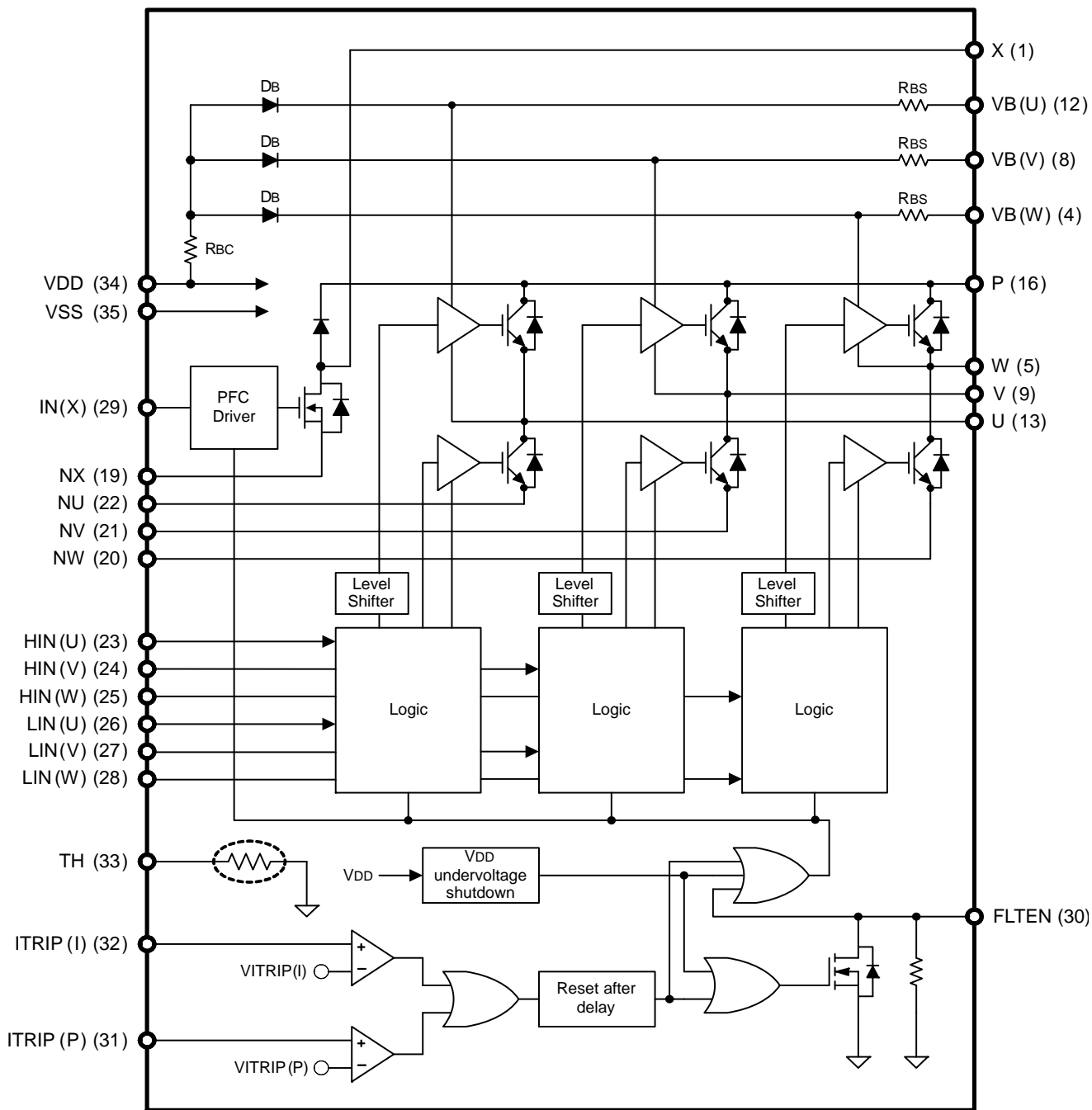

Figure 3. Equivalent Block Diagram

# NFCS1060L3TT

**Table 1. PIN FUNCTION DESCRIPTION**

Pin	Name	Description
1	X	X Phase MOSFET Drain for PFC Inductor Connection
4	VB(W)	High-Side Bias Voltage for W Phase IGBT Driving
5	W	Output for W Phase and High-Side Bias Voltage GND for W Phase IGBT Driving
8	VB(V)	High-Side Bias Voltage for V Phase IGBT Driving
9	V	Output for V Phase and High-Side Bias Voltage GND for V Phase IGBT Driving
12	VB(U)	High-Side Bias Voltage for U Phase IGBT Driving
13	U	Output for U Phase and High-Side Bias Voltage GND for U Phase IGBT Driving
16	P	Positive DC-Link Input / Positive PFC Output Voltage
19	NX	X Phase MOSFET Source for PFC
20	NW	Negative DC-Link Input for W Phase
21	NV	Negative DC-Link Input for V Phase
22	NU	Negative DC-Link Input for U Phase
23	HIN(U)	Signal Input for High-Side U Phase
24	HIN(V)	Signal Input for High-Side V Phase
25	HIN(W)	Signal Input for High-Side W Phase
26	LIN(U)	Signal Input for Low-Side U Phase
27	LIN(V)	Signal Input for Low-Side V Phase
28	LIN(W)	Signal Input for Low-Side W Phase
29	IN(X)	Signal Input for PFC X Phase
30	FLTEN	Fault Output / Enable
31	ITRIP(P)	Input for Current Protection for PFC
32	ITRIP(I)	Input for Current Protection for Inverter
33	TH	Thermistor Bias Voltage
34	VDD	Low-Side Bias Voltage for IC and IGBTs Driving
35	VSS	Low-Side Common Supply Ground

NOTE: Pins 2, 3, 6, 7, 10, 11, 14, 15, 17 and 18 are not present.

# NFCS1060L3TT

**Table 2. ABSOLUTE MAXIMUM RATINGS** (Note 1)

T<sub>C</sub> = 25°C unless otherwise noted

Rating	Symbol	Conditions	Value	Unit	
<b>PFC Section</b>					
PFC MOSFET	Drain–Source Voltage	VDSS	X – NX	600	V
	Drain Current (peak)	IDP	Pulse Width < 100 ms, VBS, VDD = 15 V	30	A
	Drain Current	ID	T <sub>C</sub> = 25 °C	20	A
			T <sub>C</sub> = 100 °C	10	A
Power Dissipation	PD1		83	W	
PFC Diode	Repetitive Reverse Voltage	VRRM	P – X	600	V
	Forward Current (peak)	IFP	Pulse Width < 100 ms	30	A
	Forward Current	IF	T <sub>C</sub> = 25 °C	20	A
			T <sub>C</sub> = 100 °C	10	A
Power Dissipation	PD2		32	W	
MOSFET Body Diode	Forward Current	ISD	T <sub>C</sub> = 25 °C	10	A
Maximum AC Input Voltage		VAC	Single–Phase Full–Rectified	277	Vrms
Maximum Output Voltage		Vo	In the Application Circuit (VAC = 200 V)	450	V
Input AC Current (steady state)		Iin		10	Arms

### Inverter Section

Supply Voltage	VPN	P – NU, NV, NW surge < 500 V (Note 2)	450	V
Collector–Emitter Voltage	VCES	P – U, V, W or U – NU, V – NV, W – NW	600	V
Each IGBT Collector Current	IC	P, U, V, W, NU, NV, NW Terminal Current	±10	A
		P, U, V, W, NU, NV, NW Terminal Current at T <sub>C</sub> = 100 °C	±5	A
Each IGBT Collector Current (peak)	ICP	P, U, V, W, NU, NV, NW Terminal Current, Pulse Width 1 ms	±20	A
Corrector Dissipation	PC	IGBT per one chip	29	W

### Driver Section

High–Side Control Bias Voltage	VBS	VB(U) – U, VB(V) – V, VB(W) – W,	–0.3 to +20.0	V
Control Supply Voltage	VDD	VDD – VSS	–0.3 to +20.0	V
Input Signal Voltage	VIN	HIN(U), HIN(V), HIN(W), LIN(U), LIN(V), LIN(W), IN(X)	–0.3 to VDD	V
Fault Output Supply Voltage and Enable Input	VFLTEN	FLTEN Terminal	–0.3 to VDD	V
ITRIP(I) Terminal Voltage	VITRIP(I)	ITRIP(I) Terminal	0.3 to +10.0	V
ITRIP(P) Terminal Voltage	VITRIP(P)	ITRIP(P) Terminal	1.5 to +2.0	V

### Intelligent Power Module Total

Operating Junction Temperature	T <sub>j</sub>		150	°C
Storage Temperature	T <sub>stg</sub>		–40 to +125	°C
Module Case Operation Temperature	T <sub>c</sub>	IPM Case Temperature	40 to +100	°C
Tightening Torque	MT	Case Mounting Screws	0.9	Nm
Isolation Voltage	Viso	60 Hz, Sinusoidal, AC 1 minute, Connection Pins to Heat Sink Plate (Note 4)	2000	Vrms

Stresses exceeding those listed in the Maximum Ratings table may damage the device. If any of these limits are exceeded, device functionality should not be assumed, damage may occur and reliability may be affected.

1. Refer to ELECTRICAL CHARACTERISTICS, RECOMMENDED OPERATING RANGES and/or APPLICATION INFORMATION for Safe Operating parameters
2. This surge voltage developed by the switching operation due to the wiring inductance between P and NU, NV, NW terminals.
3. VBS = VB(U) – U, VB(V) – V, VB(W) – W
4. Test conditions : AC 2500 V, 1 sec

# NFCS1060L3TT

**Table 3. THERMAL CHARACTERISTICS**

Rating	Symbol	Conditions	Min	Typ	Max	Unit
Junction to Case Thermal Resistance	Rth(j-c) M	PFC MOSFET	–	1.3	1.5	°C/W
	Rth(j-c) R	PFC Diode	–	3.2	3.9	°C/W
	Rth(j-c) Q	Inverter IGBT Part (per 1/6 Module)	–	3.5	4.2	°C/W
	Rth(j-c) F	Inverter FRD Part (per 1/6 Module)	–	6.8	8.2	°C/W

5. Refer to ELECTRICAL CHARACTERISTICS, RECOMMENDED OPERATING RANGES and/or APPLICATION INFORMATION for Safe Operating parameters

**Table 4. RECOMMENDED OPERATING RANGES**

Rating	Symbol	Conditions	Min	Typ	Max	Unit
Supply Voltage	VPN	P – NX, NU, NV, NW	0	280	400	V
High-Side Control Bias Voltage	VBS	VB(U) – U, VB(V) – V, VB(W) – W	13.0	15	17.5	V
Control Supply Voltage	VDD	VDD – VSS (see table note below)	14.0	15	16.5	V
ON Threshold Voltage	VIN(ON)	HIN(U), HIN(V), HIN(W), LIN(U), LIN(V), LIN(W), IN(X)	2.5	–	5.0	V
OFF Threshold Voltage	VIN(OFF)		0	–	0.3	V
PWM Frequency (PFC)	fPWMp		1	–	125	kHz
		No load, Duty = 0.5, Tc = 25 °C	1	–	300	kHz
PWM Frequency (Inverter)	fPWMi		1	–	20	kHz
Dead Time	DT	Turn-off to Turn-on (external)	1	–	–	µs
Allowable Input Pulse Width	PWIN	ON and OFF	1	–	–	µs
Tightening Torque		'M3' Type Screw	0.6	–	0.9	Nm

Functional operation above the stresses listed in the Recommended Operating Ranges is not implied. Extended exposure to stresses beyond the Recommended Operating Ranges limits may affect device reliability.

**Table 5. ELECTRICAL CHARACTERISTICS**

T<sub>C</sub> = 25 °C, VBIAS (VBS, VDD) = 15 V unless otherwise noted.

Parameter	Test Conditions	Symbol	Min	Typ	Max	Unit
<b>PFC Section</b>						
Drain-Source Leakage Current	VDSS = 600 V	IDSS	–	–	100	µA
Reverse Leakage Current (PFC Diode)	VRRM = 600 V	IR	–	–	500	µA
Drain-Source On Resistance	ID = 20 A, Tj = 25 °C	RDS(on)	–	0.125	0.18	Ω
	ID = 10 A, Tj = 100 °C		–	0.23	–	Ω
Diode Forward Voltage (PFC Diode)	IF = 20 A, Tj = 25 °C	VF	–	1.85	2.6	V
	IF = 10 A, Tj = 100 °C		–	1.55	–	V
MOSFET Body Diode Forward Voltage	IF = 10 A, Tj = 25 °C	VSD	–	1.0	1.5	V
Switching Time	ID = 20 A, VPN = 300 V, Tj = 25 °C	ton	–	0.4	0.9	µs
		toff	–	0.6	1.1	µs
<b>Inverter Section</b>						
Collector-Emitter Leakage Current	VCES = 600 V	ICES	–	–	100	µA
Bootstrap Diode Leakage Current	VRRM(DB) = 600 V	IR(DB)	–	–	100	µA
Collector-Emitter Saturation Voltage	IC = 10 A, Tj = 25 °C	VCE(sat)	–	2.0	2.65	V
	IC = 5 A, Tj = 100 °C		–	1.7	–	V
FWDi Forward Voltage	IF = 10 A, Tj = 25 °C	VF	–	1.8	2.4	V
	IF = 5 A, Tj = 100 °C		–	1.4	–	V
Switching Times	IC = 10 A, VPN = 300 V, Tj = 25 °C	ton	–	0.5	1.0	µs
		toff	–	0.6	1.1	µs

# NFCS1060L3TT

**Table 5. ELECTRICAL CHARACTERISTICS** (continued)

T<sub>C</sub> = 25 °C, VBIAS (VBS, VDD) = 15 V unless otherwise noted.

Parameter	Test Conditions	Symbol	Min	Typ	Max	Unit
Turn-on Switching Loss	IC = 10 A, VPN = 300 V, T <sub>j</sub> = 25 °C	E <sub>ON</sub>	–	295	–	μJ
Turn-off Switching Loss		E <sub>OFF</sub>	–	155	–	μJ
Total Switching Loss		E <sub>TOT</sub>	–	450	–	μJ
Turn-on Switching Loss	IC = 5 A, VPN = 300 V, T <sub>j</sub> = 100 °C	E <sub>ON</sub>	–	195	–	μJ
Turn-off Switching Loss		E <sub>OFF</sub>	–	115	–	μJ
Total Switching Loss		E <sub>TOT</sub>	–	310	–	μJ
Diode Reverse Recovery Energy	IC = 5 A, VPN = 300 V, T <sub>j</sub> = 100 °C	E <sub>REC</sub>	–	50	–	μJ
Diode Reverse Recovery Time		trr	–	200	–	ns
Reverse Bias Safe Operating Area	IC = 20 A, VCES = 450 V	RBSOA	Full Square			–
Short Circuit Safe Operating Area	VCES = 400 V, T <sub>j</sub> = 150 °C	SCSOA	5	–	–	μs
Allowable Offset Voltage Slew Rate	U – NU, V – NV, W – NW	dv/dt	–50	–	50	V/ns

## Driver Section

Quiescent VBS Supply Current	VBS = 15 V, per driver	IQBS	–	0.08	0.4	mA
Quiescent VDD Supply Current	VDD = 15 V	IQDD	–	0.85	2.4	mA
ON Threshold Voltage	HIN(U), HIN(V), HIN(W), LIN(U), LIN(V), LIN(W), IN(X) – VSS	VIN(ON)	2.5	–	–	V
OFF Threshold Voltage		VIN(OFF)	–	–	0.8	V
Logic Input Current	VIN = +3.3 V	I <sub>IN+</sub>	–	100	143	μA
Logic Input Current	VIN = 0 V	I <sub>IN–</sub>	–	–	2	μA
Bootstrap Diode Forward Voltage	IF(DB) = 0.1 A	VF(DB)	–	0.8	–	V
Bootstrap Circuit Resistance	Resistor Value for Common Boot Charge Line	RBC	–	2	–	Ω
	Resistor Values for Separate Boot Charge Lines	RBS	–	10	–	Ω
FLTEN Terminal Sink Current	VFLTEN : ON / VFAULT = 0.1 V	I <sub>oSD</sub>	–	2	–	mA
FLTEN Output Pulse Width		t <sub>FO</sub>	1.0	–	3.0	ms
FLTEN Threshold	VEN ON–state Voltage	VEN(ON)	2.5	–	–	V
	VEN OFF–state Voltage	VEN(OFF)	–	–	0.8	V
ITRIP(I) Threshold Voltage	ITRIP(I) – VSS	VITRIPth(I)	0.44	0.49	0.54	V
ITRIP(P) Threshold Voltage	ITRIP(P) – VSS	VITRIPth(P)	0.37	–0.31	–0.25	V
Shutdown Propagation Delay for INV		t <sub>ITRIP(I)</sub>	490	600	850	ns
Shutdown Propagation Delay for PFC		t <sub>ITRIP(P)</sub>	440	550	800	ns
ITRIP Blanking Time		t <sub>ITRIPBL</sub>	290	350	–	ns
Supply Circuit Under–voltage Protection	Reset Level	UVBSR UVDDR	10.5	11.1	11.7	V
Supply Circuit Under–voltage Protection	Detection Level	UVBSD UVDDD	10.3	10.9	11.5	V
Supply Circuit Under–voltage Protection Hysteresis		UVBSHYS UVDDHYS	0.14	0.2	–	V

Product parametric performance is indicated in the Electrical Characteristics for the listed test conditions, unless otherwise noted. Product performance may not be indicated by the Electrical Characteristics if operated under different conditions.

TYPICAL CHARACTERISTICS – PFC SECTION

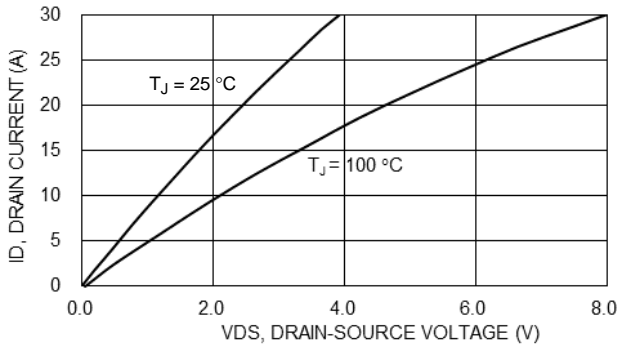

Figure 4. VDS versus ID for Different Temperatures (VDD = 15 V)

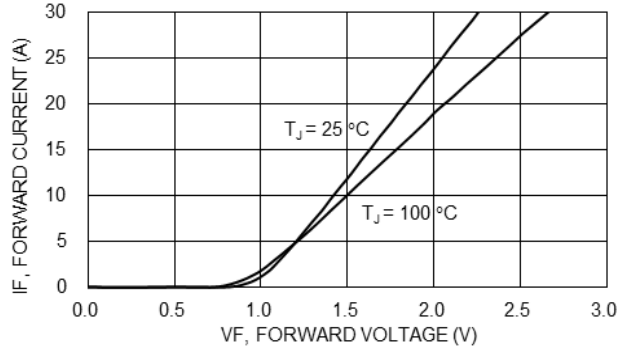

Figure 5. PFC Diode VF versus IF for Different Temperatures

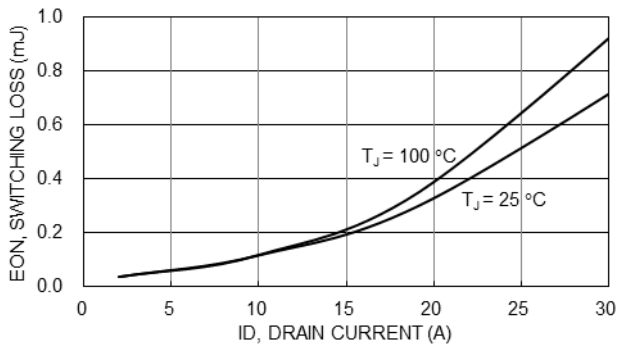

Figure 6. EON versus ID for Different Temperatures

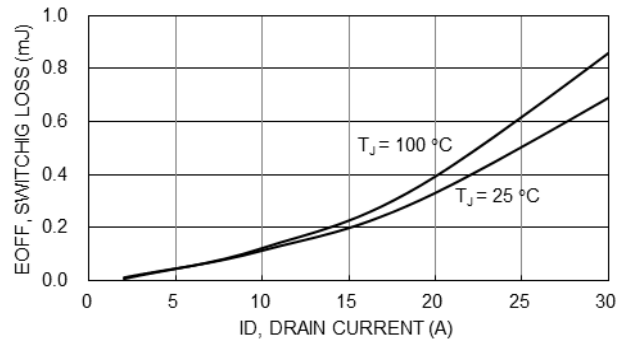

Figure 7. EOFF versus ID for Different Temperatures

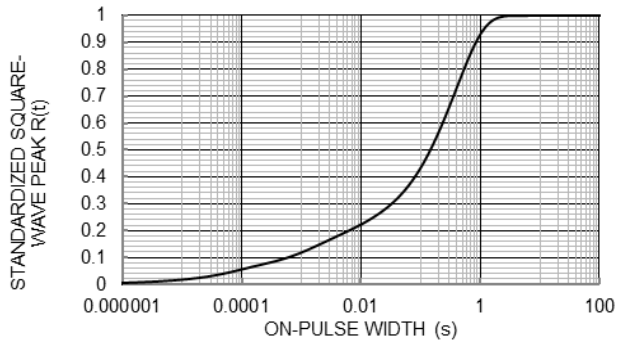

Figure 8. Thermal Impedance Plot (PFC MOSFET)

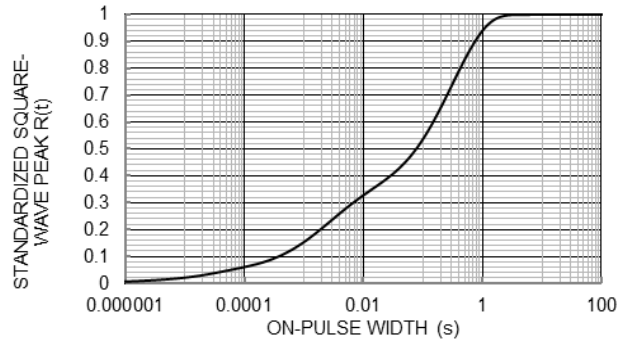

Figure 9. Thermal Impedance Plot (PFC Diode)

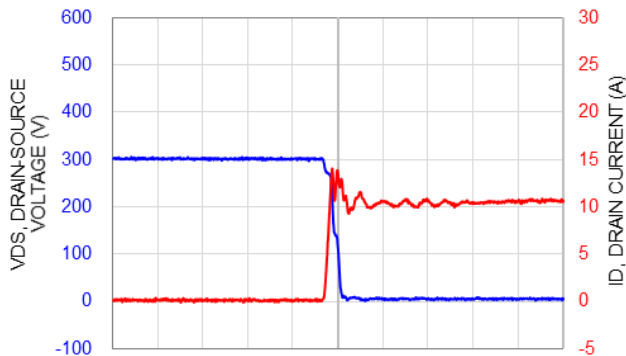

Figure 10. Turn-on Waveform Tj = 100°C, VPN = 300 V

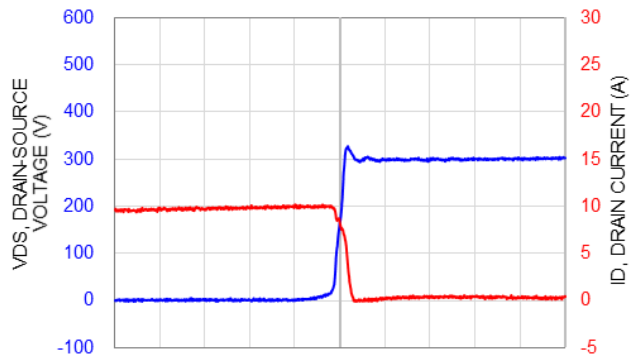

Figure 11. Turn-off Waveform Tj = 100°C, VPN = 300 V



TYPICAL CHARACTERISTICS – INVERTER SECTION

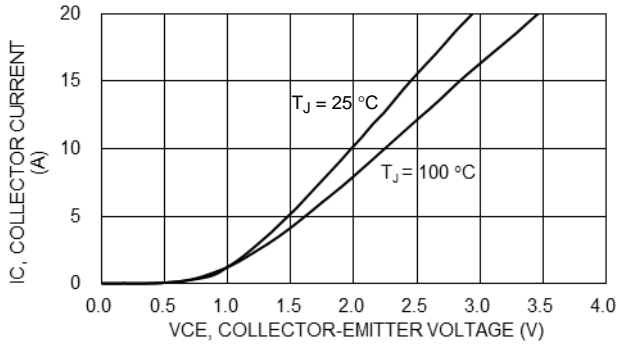

Figure 12. VCE versus IC for Different Temperatures (VDD/VBS = 15 V)

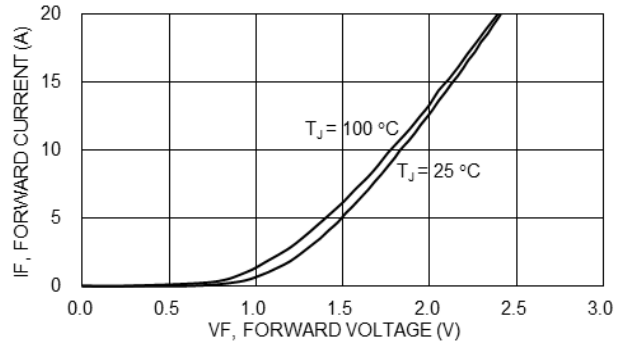

Figure 13. VF versus IF for Different Temperatures

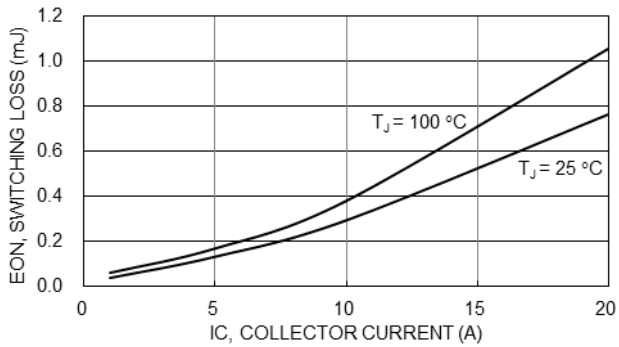

Figure 14. EON versus IC for Different Temperatures

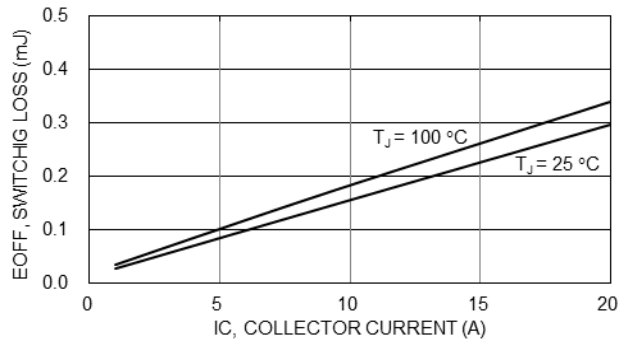

Figure 15. EOFF versus IC for Different Temperatures

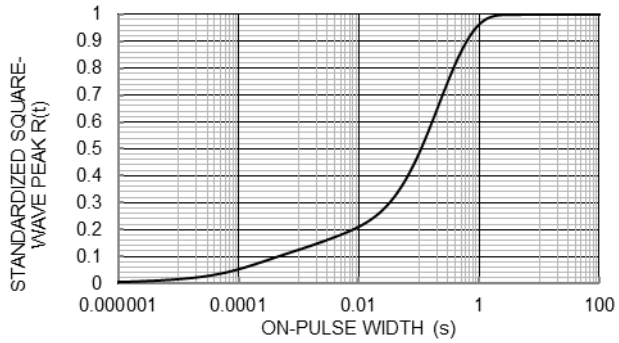

Figure 16. Thermal Impedance Plot (IGBT)

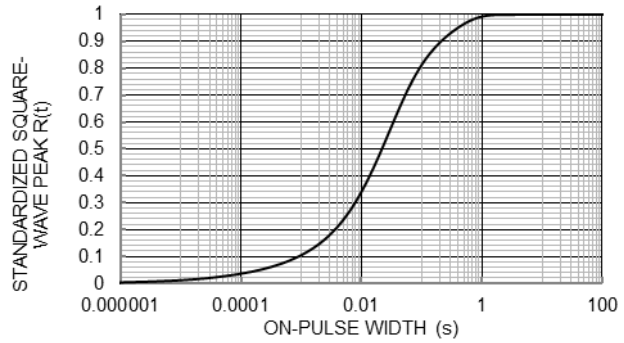

Figure 17. Thermal Impedance Plot (FRD)

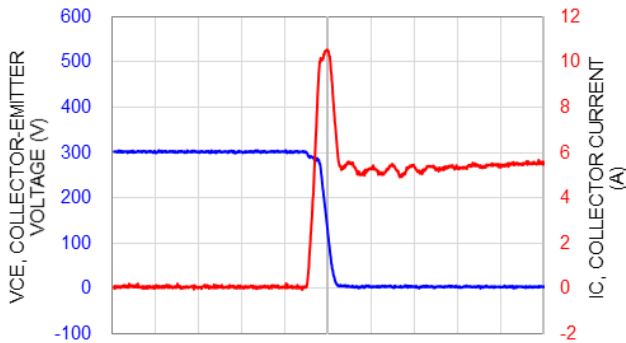

Figure 18. Turn-on Waveform Tj = 100 °C, VPN = 300 V

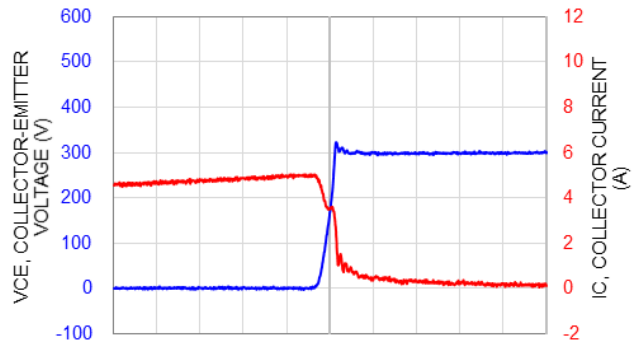
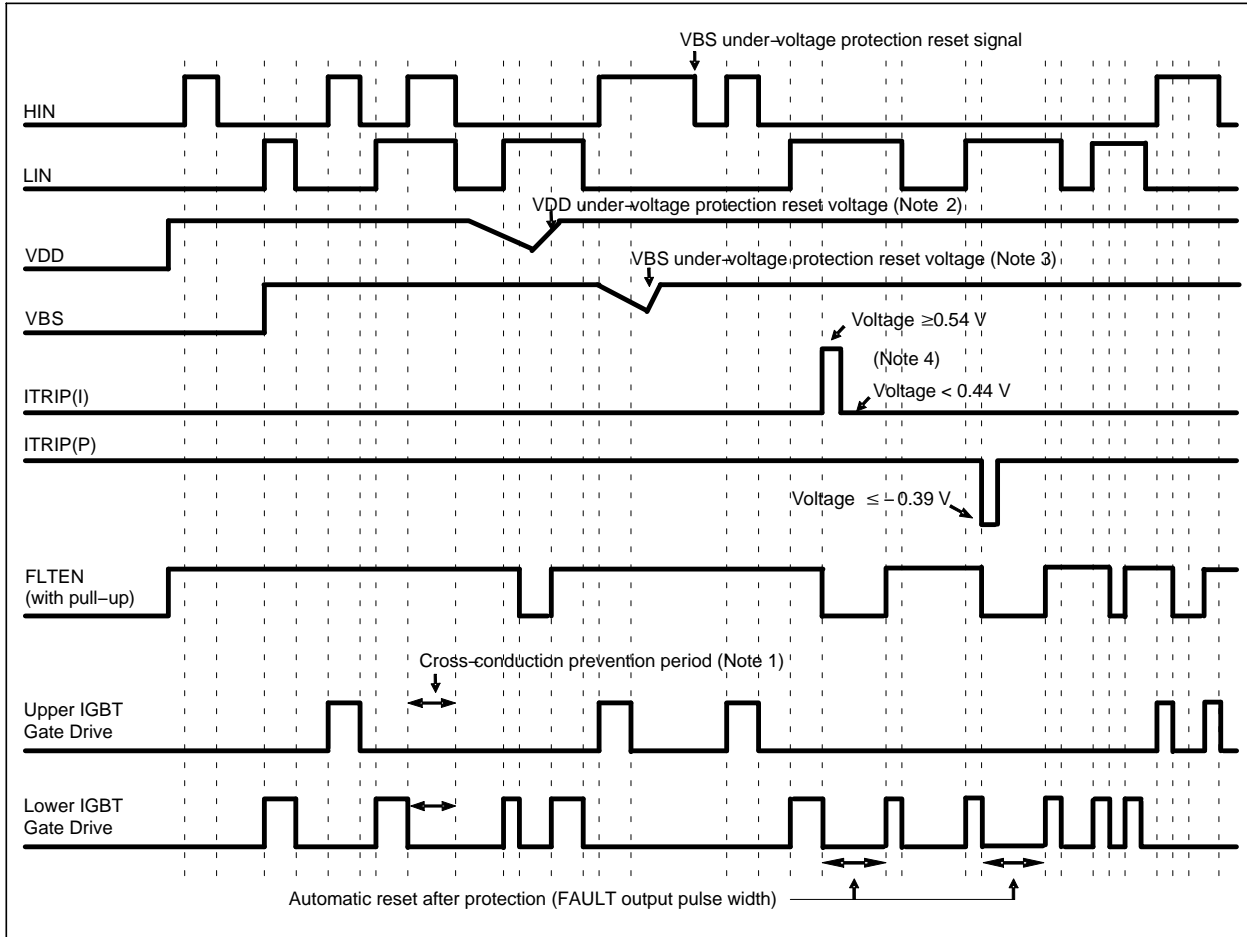

Figure 19. Turn-off Waveform Tj = 100 °C, VPN = 300 V

# NFCS1060L3TT

## APPLICATIONS INFORMATION

### Input / Output Timing Chart



#### NOTES:

1. This section of the timing diagram shows the effect of cross-conduction prevention.
2. This section of the timing diagram shows that when the voltage on VDD decreases sufficiently all gate output signals will go low, switching off all six IGBTs and PFC MOSFET. When the voltage on VDD rises sufficiently, normal operation will resume.
3. This section shows that when the bootstrap voltage on VBS drops, the corresponding high side output U (V, W) is switched off. When the voltage on VBS rises sufficiently, normal operation will resume.
4. This section shows that when the voltage on ITRIP(I) exceeds the threshold, all IGBTs and PFC MOSFET are turned off. Normal operation resumes later after the over-current condition is removed. Similarly, when the voltage on ITRIP(P) exceeds the threshold, all IGBTs and PFC MOSFET are turned off. Normal operation resumes later after the over-current condition is removed.
5. After VDD has risen above the threshold to enable normal operation, the driver waits to receive an input signal on the LIN input before enabling the driver for the HIN signal.

Figure 20. Input / Output Timing Chart

Table 6. INPUT / OUTPUT LOGIC TABLE

INPUT				OUTPUT			
HIN	LIN	ITRIP(I)	ITRIP(P)	High side IGBT	Low side IGBT	U,V,W	VFLTEN
H	L	L	L	ON (Note 5)	OFF	P	OFF
L	H	L	L	OFF	ON	NU,NV,NW	OFF
L	L	L	L	OFF	OFF	High Impedance	OFF
H	H	L	L	OFF	OFF	High Impedance	OFF
X	X	H	X	OFF	OFF	High Impedance	ON
X	X	X	H	OFF	OFF	High Impedance	ON

# NFCS1060L3TT

**Table 7. THERMISTOR CHARACTERISTICS**

Parameter	Symbol	Condition	Min	Typ	Max	Unit
Resistance	R <sub>25</sub>	T <sub>c</sub> = 25°C	44.65	47	49.35	kΩ
	R <sub>125</sub>	T <sub>c</sub> = 125°C	1.29	1.41	1.53	kΩ
B-Constant (25–50°C)	–	B	4009.5	4050	4090.5	K
Temperature Range	–	–	–40	–	+125	°C

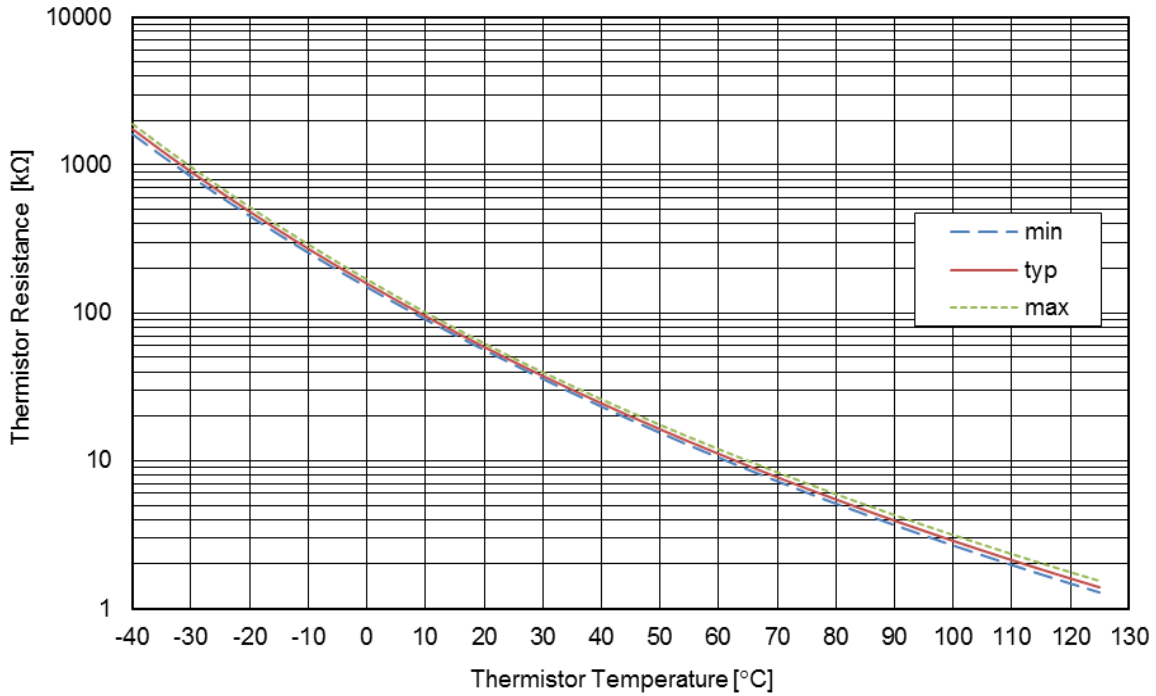

**Figure 21. Thermistor Resistance – Thermistor Temperature**

**Signal Inputs**

Each signal input has a pull-down resistor internally. An additional pull-down resistor of between 2.2 kΩ and 3.3 kΩ is recommended on each input to improve noise immunity.

**FLTEN pin**

The FLTEN pin is connected internally to an open-drain FAULT output and an ENABLE input requiring a pull-up resistor. If the pull-up voltage is 5 V, use a pull-up resistor with a value of 6.8 kΩ or higher. If the pull-up voltage is 15 V, use a pull-up resistor with a value of 20 kΩ or higher. The pulled up voltage in normal operation for the FLTEN pin should be above 2.5 V, noting that it is connected to an internal ENABLE input. The FAULT output is triggered if there is a VDD under-voltage or an overcurrent condition on either the PFC or inverter stages.

Driving the FLTEN terminal pin is used to enable or shut down the built-in driver. If the voltage on the FLTEN pin rises above the positive going FLTEN threshold, the output drivers are enabled. If the voltage on the FLTEN pin falls below the negative going FLTEN threshold, the drivers are disabled.

**Under-voltage Protection**

If VDD goes below the VDD supply undervoltage lockout falling threshold, the FAULT output is switched on. The FAULT output stays on until VDD rises above the VDD supply under-voltage lockout rising threshold. The hysteresis is approximately 200 mV.

**Overcurrent Protection**

An over-current condition is detected if the voltage on the ITRIP(I) or ITRIP(P) pins are exceed the reference voltage (Refer to Table 6 – Input / Output Logic Table). There is a blanking time of typically 350 ns to improve noise immunity. After a shutdown propagation delay of typically 0.6 μs, the FAULT output is switched on.

The over-current protection threshold should be set to be equal or lower to 2 times the module rated current (Io).

An additional fuse is recommended to protect against system level or abnormal over-current fault conditions.

**Capacitors on High Voltage and VDD supplies**

Both the high voltage and VDD supplies require an electrolytic capacitor and an additional high frequency capacitor. The recommended value of the high frequency capacitor is between 100 nF and 10 μF.

**Minimum Input Pulse Width**

When input pulse width is less than 1 μs, an output may not react to the pulse. (Both ON signal and OFF signal)

**Calculation of Bootstrap Capacitor Value**

The bootstrap capacitor value CB is calculated using the following approach. The following parameters influence the choice of bootstrap capacitor:

- VBS: Bootstrap power supply.  
15 V is recommended.
- QG: Total gate charge of IGBT at VBS = 15 V.  
12.7 nC
- UVLO: Falling threshold for UVLO.  
Specified as 12 V.
- IDMAX: High side drive power dissipation.  
Specified as 0.4 mA
- TONMAX: Maximum ON pulse width of high side IGBT.

Capacitance calculation formula:

$$CB = (QG + IDMAX * TONMAX)/(VBS - UVLO)$$

CB is recommended to be approximately 3 times the value calculated above. The recommended value of CB is in the range of 1 to 47 μF, however, the value needs to be verified prior to production. When not using the bootstrap circuit, each high side driver power supply requires an external independent power supply.

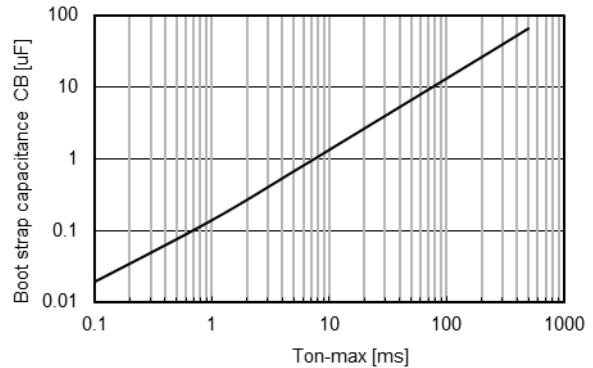

**Figure 22. Bootstrap Capacitance versus Ton-max**

Table 8. MOUNTING INSTRUCTIONS

Item	Recommended Condition
Pitch	56.0 ± 0.1 mm (Please refer to MECHANICAL CASE OUTLINE)
Screw	Diameter : M3 Screw head types: pan head, truss head, binding head
Washer	Plane washer The size is D: 7 mm, d: 3.2 mm and t: 0.5 mm JIS B 1256
Heat sink	Material: Aluminum or Copper Warpage (the surface that contacts IPM) : -50 to 100 μm Screw holes must be countersunk. No contamination on the heat sink surface that contacts IPM.
Torque	Temporary tightening : 20 to 30 % of final tightening on first screw Temporary tightening : 20 to 30 % of final tightening on second screw Final tightening : 0.6 to 0.9 Nm on first screw Final tightening : 0.6 to 0.9 Nm on second screw
Grease	Silicone grease. Thickness : 100 to 200 μm Uniformly apply silicone grease to whole back. Thermal foils are only recommended after careful evaluation. Thickness, stiffness and compressibility parameters have a strong influence on performance.

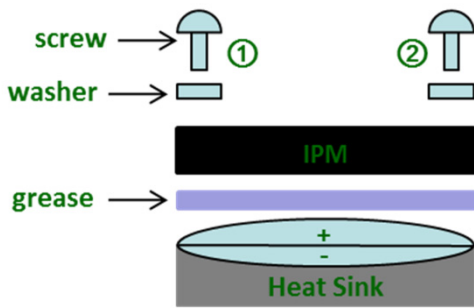

Figure 23. Mount IPM on a Heat Sink

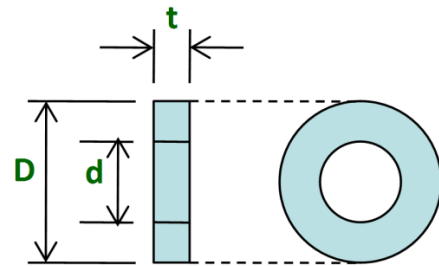

Figure 24. Size of Washer

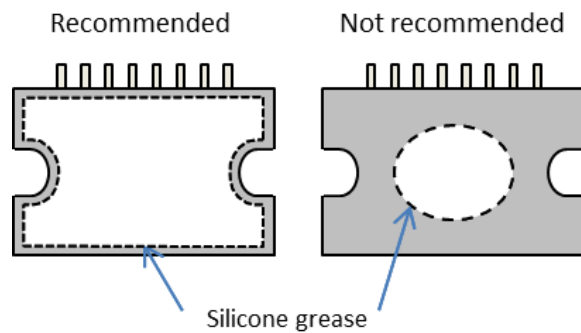

Figure 25. Uniform Application of Grease Recommended

**Steps to mount an IPM on a heat sink**

- 1<sup>st</sup> : Temporarily tighten maintaining a left/right balance.
- 2<sup>nd</sup> : Finally tighten maintaining a left/right balance.



• VITRIP(I), VITRIP(P)

	VITRIP(I) (U-)	VITRIP(P)
A	13	1
B	22	19
C	26	29
D	32	31

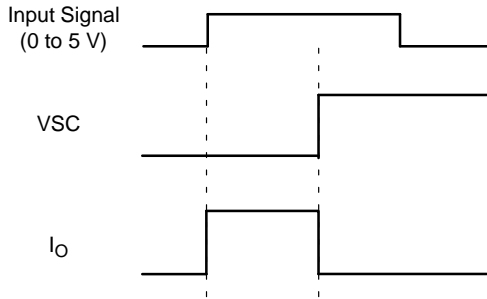

Figure 30.

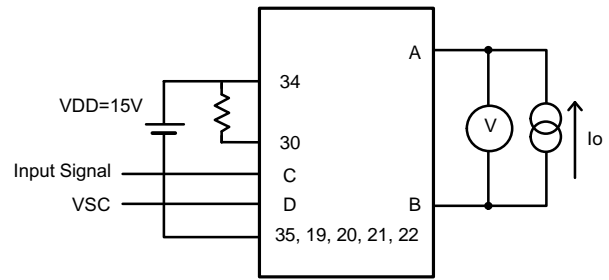

Figure 31. Test Circuit for VITRIP(I), VITRIP(P)

• Switching Time (The circuit is a representative example of the Inverter Low side U phase.)

	Inverter High Side			Inverter Low Side			PFC MOSFET
	U	V	W	U	V	W	
A	16	16	16	16	16	16	16
B	22	21	20	22	21	20	19
C	13	9	5	13	9	5	1
D	22	21	20	16	16	16	16
E	23	24	25	26	27	28	29

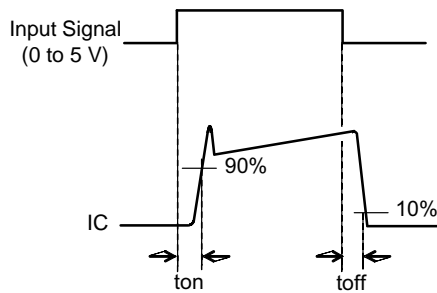

Figure 32.

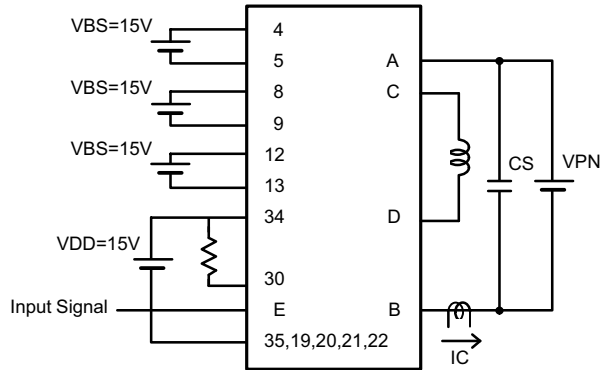

Figure 33. Test Circuit for Switching Time

# MECHANICAL CASE OUTLINE

## PACKAGE DIMENSIONS



SIP35 56x25.8 / SIP2A-2  
CASE 127DT  
ISSUE A

DATE 05 MAR 2019

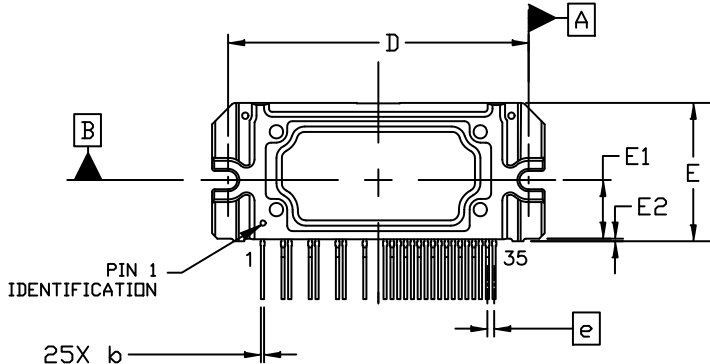

NOTE 3  
NOTE 4

TOP VIEW

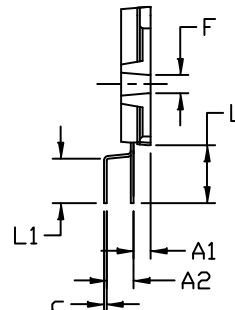

NOTE 3

END VIEW

DIM	MILLIMETERS		
	MIN.	NOM.	MAX.
A	5.00	5.50	6.00
A1	2.70	3.20	3.70
A2	4.50	5.00	5.50
A3	1.50	2.00	2.50
b	0.55	0.60	0.80
c	0.45	0.50	0.70
D	55.50	56.00	56.50
D1	61.50	62.00	62.50
D2	49.50	50.00	50.50
D3	45.70	46.20	46.70
E	25.30	25.80	26.30
E1	10.90 REF		
E2	0.00	0.50	1.00
e	1.27 BSC		
F	2.90	3.40	3.90
L	10.30	10.80	11.30
L1	7.80	8.30	8.80

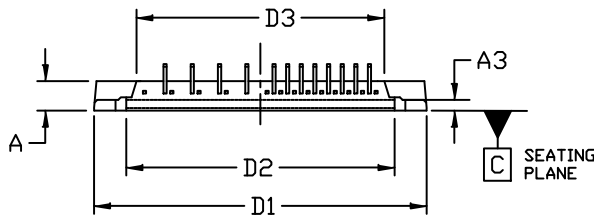

SIDE VIEW

NOTES:

1. DIMENSIONING AND TOLERANCING PER ASME Y14.5M, 2009.
2. CONTROLLING DIMENSION: MILLIMETERS
3. DIMENSIONS b AND c APPLY TO THE PLATED LEAD AND ARE MEASURED BETWEEN 1.00 AND 2.00 FROM THE LEAD TIP.
4. POSITION OF THE LEADS IS DETERMINED AT THE ROOT OF THE LEAD WHERE IT EXITS THE PACKAGE BODY.
5. MIRROR SURFACE MARK INDICATES PIN 1 POSITION.
6. MISSING PINS ARE: 2, 3, 6, 7, 10, 11, 14, 15, 17, AND 18.

GENERIC MARKING DIAGRAM\*

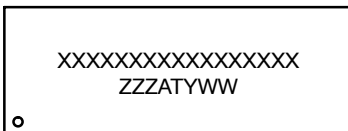

XXXX = Specific Device Code  
ZZZ = Assembly Lot Code  
AT = Assembly & Test Location  
Y = Year  
WW = Work Week

\*This information is generic. Please refer to device data sheet for actual part marking. Pb-Free indicator, "G" or microdot "•", may or may not be present. Some products may not follow the Generic Marking.

DOCUMENT NUMBER:	98AON04875G	Electronic versions are uncontrolled except when accessed directly from the Document Repository. Printed versions are uncontrolled except when stamped "CONTROLLED COPY" in red.
DESCRIPTION:	SIP35 56X25.8 / SIP2A-2	PAGE 1 OF 1

ON Semiconductor and are trademarks of Semiconductor Components Industries, LLC dba ON Semiconductor or its subsidiaries in the United States and/or other countries. ON Semiconductor reserves the right to make changes without further notice to any products herein. ON Semiconductor makes no warranty, representation or guarantee regarding the suitability of its products for any particular purpose, nor does ON Semiconductor assume any liability arising out of the application or use of any product or circuit, and specifically disclaims any and all liability, including without limitation special, consequential or incidental damages. ON Semiconductor does not convey any license under its patent rights nor the rights of others.



ON Semiconductor and  are trademarks of Semiconductor Components Industries, LLC dba ON Semiconductor or its subsidiaries in the United States and/or other countries. ON Semiconductor owns the rights to a number of patents, trademarks, copyrights, trade secrets, and other intellectual property. A listing of ON Semiconductor's product/patent coverage may be accessed at [www.onsemi.com/site/pdf/Patent-Marking.pdf](http://www.onsemi.com/site/pdf/Patent-Marking.pdf). ON Semiconductor reserves the right to make changes without further notice to any products herein. ON Semiconductor makes no warranty, representation or guarantee regarding the suitability of its products for any particular purpose, nor does ON Semiconductor assume any liability arising out of the application or use of any product or circuit, and specifically disclaims any and all liability, including without limitation special, consequential or incidental damages. Buyer is responsible for its products and applications using ON Semiconductor products, including compliance with all laws, regulations and safety requirements or standards, regardless of any support or applications information provided by ON Semiconductor. "Typical" parameters which may be provided in ON Semiconductor data sheets and/or specifications can and do vary in different applications and actual performance may vary over time. All operating parameters, including "Typicals" must be validated for each customer application by customer's technical experts. ON Semiconductor does not convey any license under its patent rights nor the rights of others. ON Semiconductor products are not designed, intended, or authorized for use as a critical component in life support systems or any FDA Class 3 medical devices or medical devices with a same or similar classification in a foreign jurisdiction or any devices intended for implantation in the human body. Should Buyer purchase or use ON Semiconductor products for any such unintended or unauthorized application, Buyer shall indemnify and hold ON Semiconductor and its officers, employees, subsidiaries, affiliates, and distributors harmless against all claims, costs, damages, and expenses, and reasonable attorney fees arising out of, directly or indirectly, any claim of personal injury or death associated with such unintended or unauthorized use, even if such claim alleges that ON Semiconductor was negligent regarding the design or manufacture of the part. ON Semiconductor is an Equal Opportunity/Affirmative Action Employer. This literature is subject to all applicable copyright laws and is not for resale in any manner.

## PUBLICATION ORDERING INFORMATION

### LITERATURE FULFILLMENT:

Email Requests to: [orderlit@onsemi.com](mailto:orderlit@onsemi.com)

ON Semiconductor Website: [www.onsemi.com](http://www.onsemi.com)

### TECHNICAL SUPPORT

North American Technical Support:  
Voice Mail: 1 800-282-9855 Toll Free USA/Canada  
Phone: 011 421 33 790 2910

### Europe, Middle East and Africa Technical Support:

Phone: 00421 33 790 2910

For additional information, please contact your local Sales Representative