

Features:

- 698-960/1710-3800 MHz
- Gain 2dBi
- IP67
- Cable and connector variants available
- Magnetic mount
- RoHS Compliant

Applications:

- Transit
- Outdoor vehicular use
- Transportation / Logistics
- High speed data over LTE



All dimensions are in mm / inches

Issue: 1802

In the effort to improve our products, we reserve the right to make changes judged to be necessary.

CONFIDENTIAL AND PROPRIETARY INFORMATION

This document contains confidential and proprietary information of Pulse Electronics, Inc. (Pulse) and is protected by copyright, trade secret and other state and federal laws. Its receipt or possession does not convey any rights to reproduce, disclose its contents, or to manufacture, use or sell anything it may describe. Reproduction, disclosure or use without specific written authorization of Pulse is strictly forbidden.

For more information:

Pulse Worldwide Headquarters
15255 Innovation Drive #100
San Diego, CA 92128
USA
Tel:1-858-674-8100

Pulse/Larsen Antennas
18110 SE 34th St Bldg 2 Suite 250
Vancouver, WA 98683
USA
Tel: 1-360-944-7551

Europe Headquarters
Pulse GmbH & Do, KG
Zeppelinstrasse 15
Herrenberg, Germany
Tel: 49 7032 7806 0

Pulse (Suzhou) Wireless Products Co, Inc.
99 Huo Ju Road(#29 Bldg,4th Phase
Suzhou New District
Jiangsu Province, Suzhou 215009 PR China
Tel: 86 512 6807 9998



This document covers all product variants of the following product family

Antennas	Cable Type	Cable Length	Connector	Weight(g)
LPT698/3800MM	RG58 Black	3000mm[118.11inch]	SMA Male	296.6
LPT698/38MM200SMA	LMR200 Black		SMA Male	300
LPT698/3800MMMMCX	RG58 Black		MMCX	300.5

Issue: 1802

In the effort to improve our products, we reserve the right to make changes judged to be necessary.

CONFIDENTIAL AND PROPRIETARY INFORMATION

This document contains confidential and proprietary information of Pulse Electronics, Inc. (Pulse) and is protected by copyright, trade secret and other state and federal laws. Its receipt or possession does not convey any rights to reproduce, disclose its contents, or to manufacture, use or sell anything it may describe. Reproduction, disclosure or use without specific written authorization of Pulse is strictly forbidden.

For more information:

Pulse Worldwide Headquarters
15255 Innovation Drive #100
San Diego, CA 92128
USA
Tel:1-858-674-8100

Pulse/Larsen Antennas
18110 SE 34th St Bldg 2 Suite 250
Vancouver, WA 98683
USA
Tel: 1-360-944-7551

Europe Headquarters
Pulse GmbH & Do, KG
Zeppelinstrasse 15
Herrenberg, Germany
Tel: 49 7032 7806 0

Pulse (Suzhou) Wireless Products Co, Inc.
99 Huo Ju Road(#29 Bldg,4th Phase
Suzhou New District
Jiangsu Province, Suzhou 215009 PR China
Tel: 86 512 6807 9998



Description: LTE 698-3800MHz Outdoor
Omni Antenna

Series: Low Profile Transit

PART NUMBER:LPT698/3800XXXX

ELECTRICAL SPECIFICATIONS

Antenna Type	Monopole
Frequency	698-960/1710-3800MHz
Nominal Impedance	50 Ω
VSWR	< 2:1
Radiation Pattern	Omni
Gain	2 dBi
Efficiency	50% @698-960MHz ; 30% @1710-3800MHz
Polarization	Vertical
Power Withstanding	45W

MECHANICAL SPECIFICATIONS

Overall Length	94.66mm
Antenna Color / Material	Black
Connector type	As required
Cable type	As required
Cable length	3000mm
Fix system	Magnetic fixing

ENVIRONMENTAL SPECIFICATIONS

Operating Temperature	-40/+85 ° C
Storage Temperature	-40/+85 ° C
Ingress Protection	IP67
Wind-loading	160 km/h
RoHS Compliant	Yes

OTHER SPECIFICATIONS

Issue: 1802

In the effort to improve our products, we reserve the right to make changes judged to be necessary.

CONFIDENTIAL AND PROPRIETARY INFORMATION

This document contains confidential and proprietary information of Pulse Electronics, Inc. (Pulse) and is protected by copyright, trade secret and other state and federal laws. Its receipt or possession does not convey any rights to reproduce, disclose its contents, or to manufacture, use or sell anything it may describe. Reproduction, disclosure or use without specific written authorization of Pulse is strictly forbidden.

MECHANICAL DRAWING

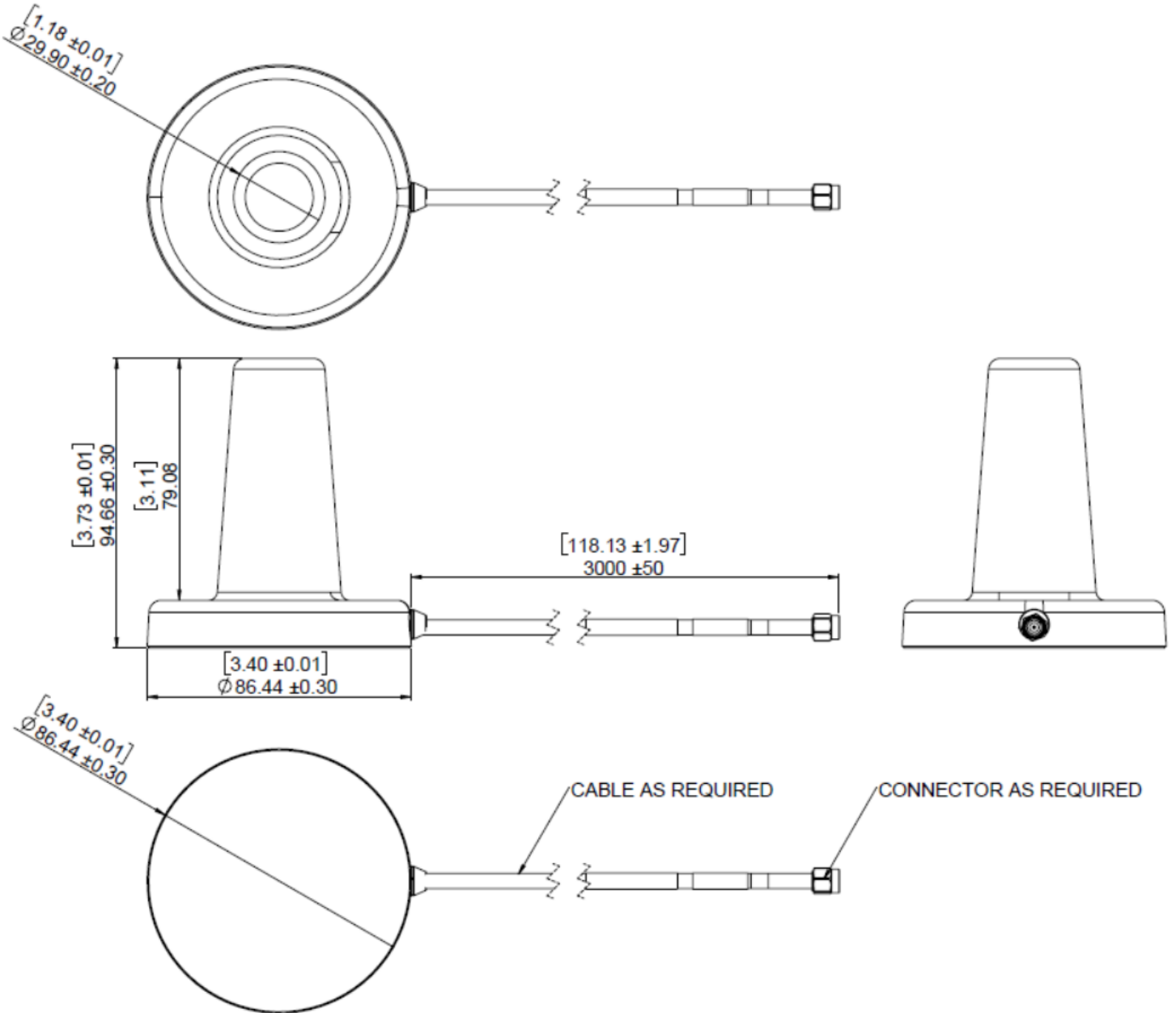

DIMENSION UNIT:MM/INCH

Issue: 1802

In the effort to improve our products, we reserve the right to make changes judged to be necessary.

CONFIDENTIAL AND PROPRIETARY INFORMATION

This document contains confidential and proprietary information of Pulse Electronics, Inc. (Pulse) and is protected by copyright, trade secret and other state and federal laws. Its receipt or possession does not convey any rights to reproduce, disclose its contents, or to manufacture, use or sell anything it may describe. Reproduction, disclosure or use without specific written authorization of Pulse is strictly forbidden.

Series: Low Profile Transit

Description: LTE 698-3800MHz Outdoor
Omni Antenna

PART NUMBER:LPT698/3800XXXX

TEST SETUP

*VSWR and radiation performance are test on $\Phi 20$ " ground plane
with 118" RG58 cable

Description: LTE 698-3800MHz Outdoor Omni Antenna

Series: Low Profile Transit

PART NUMBER: LPT698/3800XXXX

CHARTS

VSWR

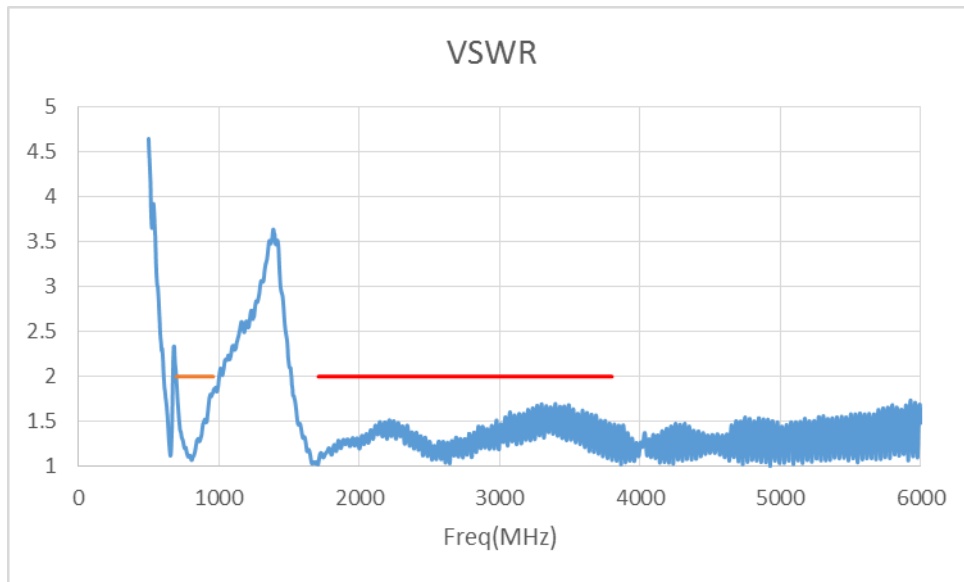

Peak Gain vs Frequency
LPT698/3800XXX Measured with 118" on Ø20" GP

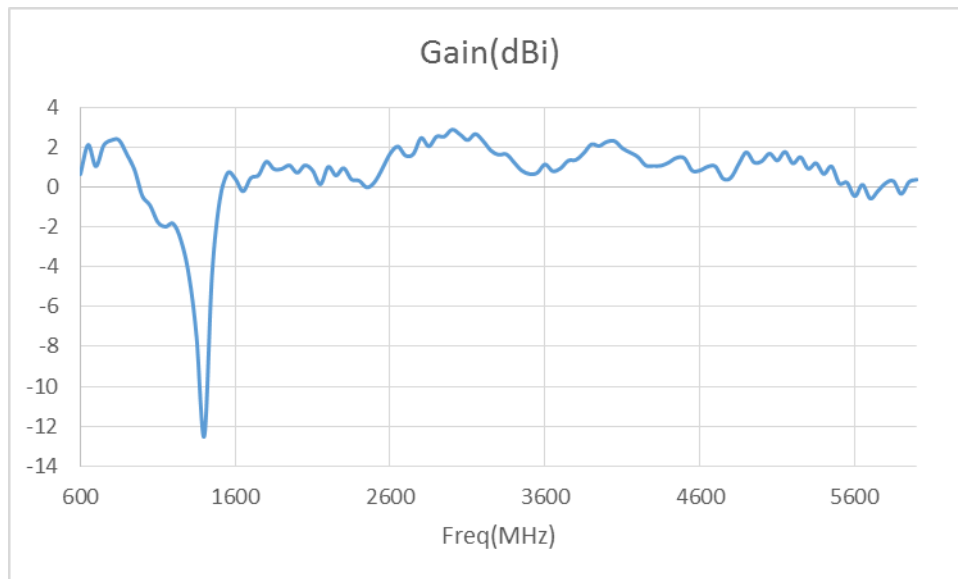

Issue: 1802

In the effort to improve our products, we reserve the right to make changes judged to be necessary.

CONFIDENTIAL AND PROPRIETARY INFORMATION

This document contains confidential and proprietary information of Pulse Electronics, Inc. (Pulse) and is protected by copyright, trade secret and other state and federal laws. Its receipt or possession does not convey any rights to reproduce, disclose its contents, or to manufacture, use or sell anything it may describe. Reproduction, disclosure or use without specific written authorization of Pulse is strictly forbidden.

Description: LTE 698-3800MHz Outdoor
Omni Antenna

Series: Low Profile Transit

PART NUMBER:LPT698/3800XXXX

CHARTS

Efficiency vs Frequency
LPT698/3800XXX Measured with 118" on $\Phi 20$ " GP

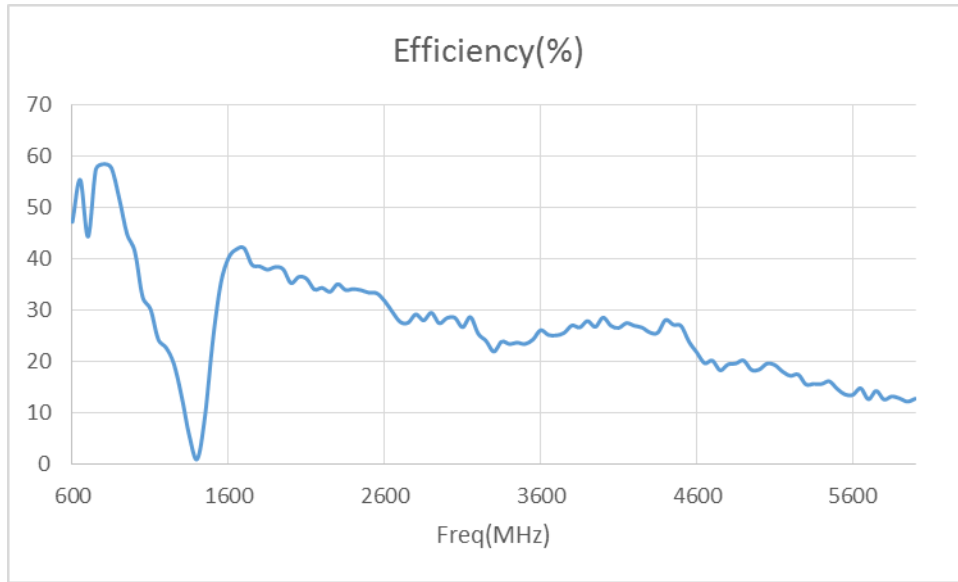

Description: LTE 698-3800MHz Outdoor Omni Antenna

Series: Low Profile Transit

PART NUMBER: LPT698/3800XXXX

CHARTS

X-Y plane radiation pattern at LTE low band*

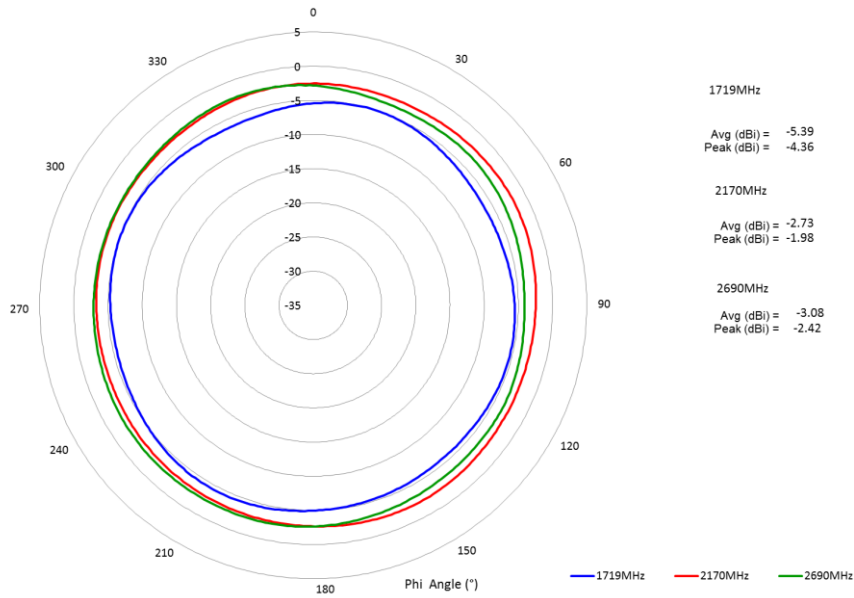

Z-X plane radiation pattern at LTE low band*

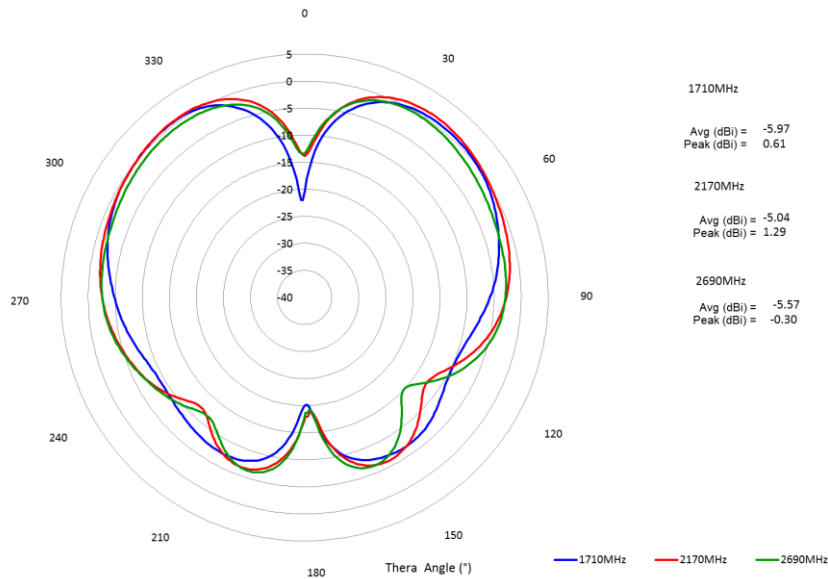

Issue: 1802

In the effort to improve our products, we reserve the right to make changes judged to be necessary.

CONFIDENTIAL AND PROPRIETARY INFORMATION

This document contains confidential and proprietary information of Pulse Electronics, Inc. (Pulse) and is protected by copyright, trade secret and other state and federal laws. Its receipt or possession does not convey any rights to reproduce, disclose its contents, or to manufacture, use or sell anything it may describe. Reproduction, disclosure or use without specific written authorization of Pulse is strictly forbidden.

Description: LTE 698-3800MHz Outdoor Omni Antenna

Series: Low Profile Transit

PART NUMBER: LPT698/3800XXXX

CHARTS

Y-Z plane radiation pattern at LTE low band*

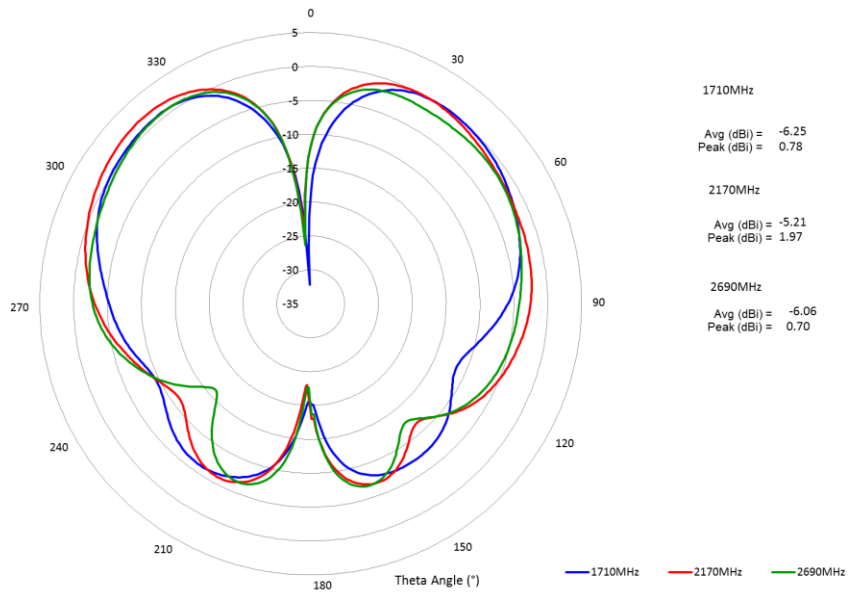

X-Y plane radiation pattern at LTE high band*

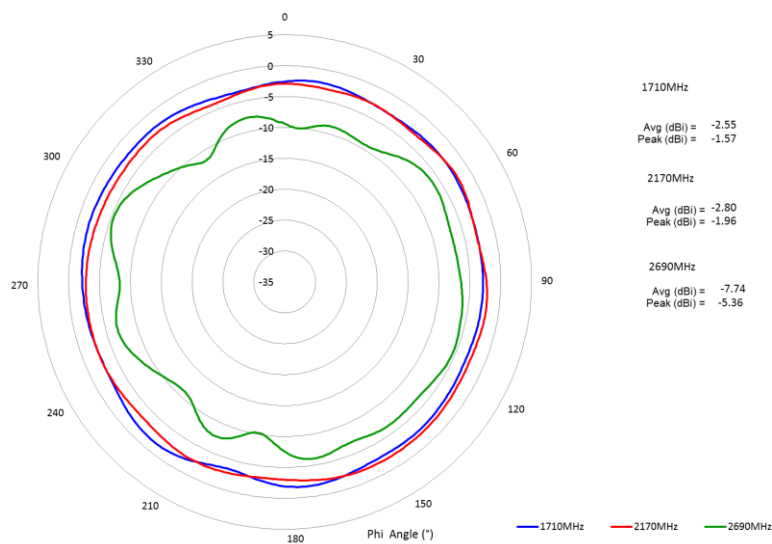

Issue: 1802

In the effort to improve our products, we reserve the right to make changes judged to be necessary.

CONFIDENTIAL AND PROPRIETARY INFORMATION

This document contains confidential and proprietary information of Pulse Electronics, Inc. (Pulse) and is protected by copyright, trade secret and other state and federal laws. Its receipt or possession does not convey any rights to reproduce, disclose its contents, or to manufacture, use or sell anything it may describe. Reproduction, disclosure or use without specific written authorization of Pulse is strictly forbidden.

CHARTS

X-Z plane radiation pattern at LTE high band*

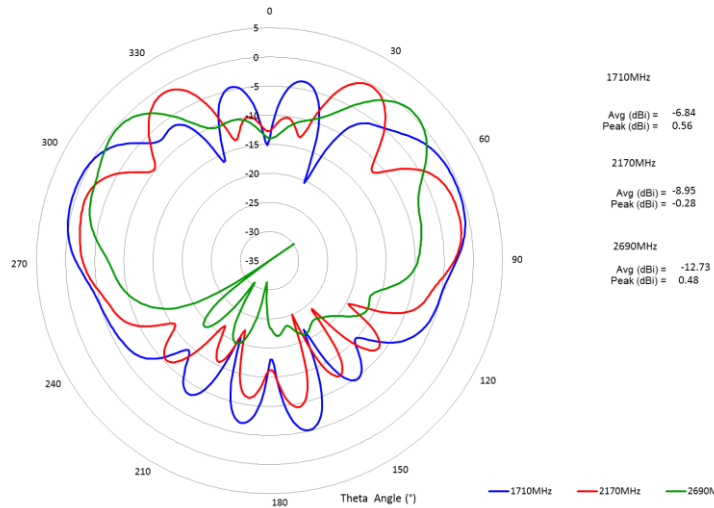

Y-Z plane radiation pattern at LTE high band*

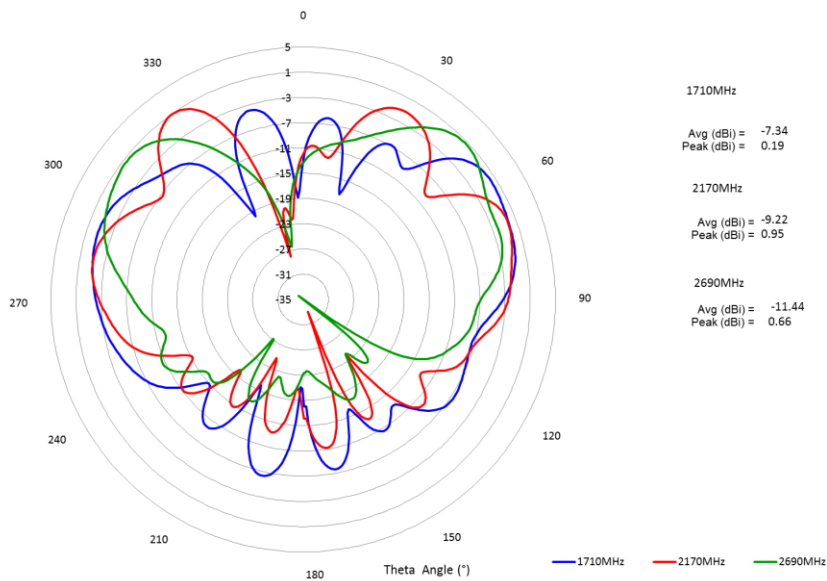

Issue: 1802

In the effort to improve our products, we reserve the right to make changes judged to be necessary.

CONFIDENTIAL AND PROPRIETARY INFORMATION

This document contains confidential and proprietary information of Pulse Electronics, Inc. (Pulse) and is protected by copyright, trade secret and other state and federal laws. Its receipt or possession does not convey any rights to reproduce, disclose its contents, or to manufacture, use or sell anything it may describe. Reproduction, disclosure or use without specific written authorization of Pulse is strictly forbidden.

Description: LTE 698-3800MHz Outdoor Omni Antenna

Series: Low Profile Transit

PART NUMBER:LPT698/3800XXXX

CHARTS

X-Y plane radiation pattern at CBRS band*

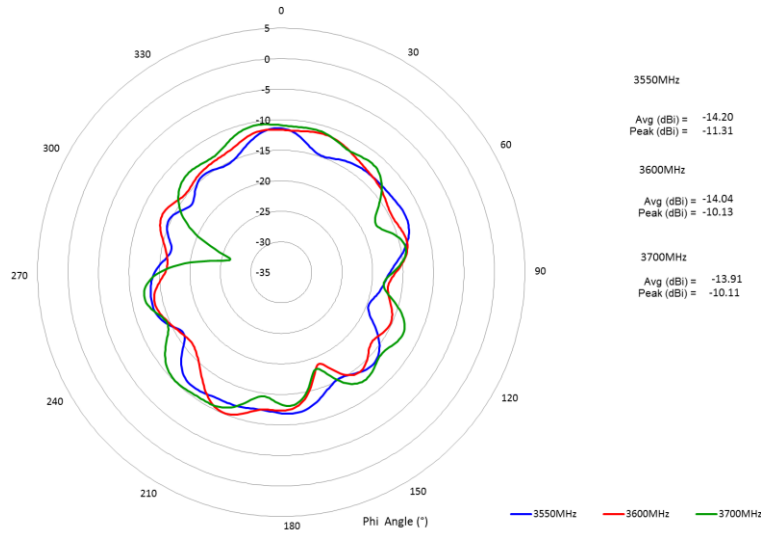

X-Z plane radiation pattern at CBRS band*

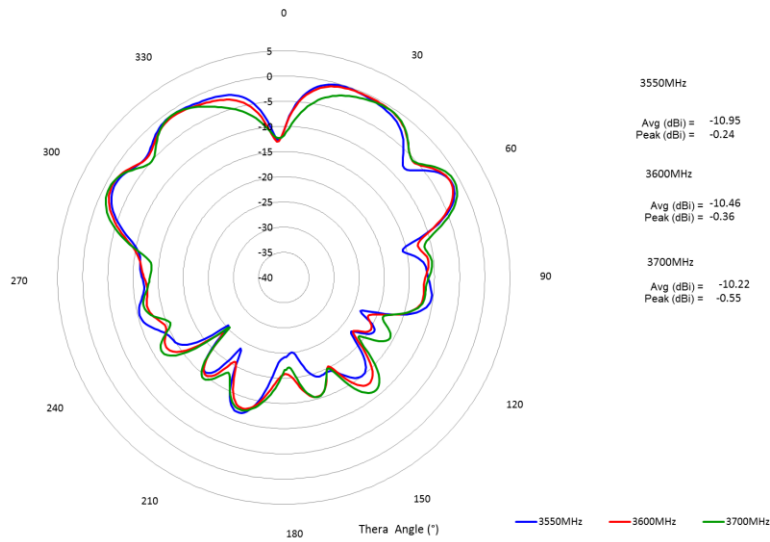

Issue: 1802

In the effort to improve our products, we reserve the right to make changes judged to be necessary.

CONFIDENTIAL AND PROPRIETARY INFORMATION

This document contains confidential and proprietary information of Pulse Electronics, Inc. (Pulse) and is protected by copyright, trade secret and other state and federal laws. Its receipt or possession does not convey any rights to reproduce, disclose its contents, or to manufacture, use or sell anything it may describe. Reproduction, disclosure or use without specific written authorization of Pulse is strictly forbidden.

Description: LTE 698-3800MHz Outdoor
Omni Antenna

Series: Low Profile Transit

PART NUMBER: LPT698/3800XXXX

CHARTS

Y-Z plane radiation pattern at CBRS band*

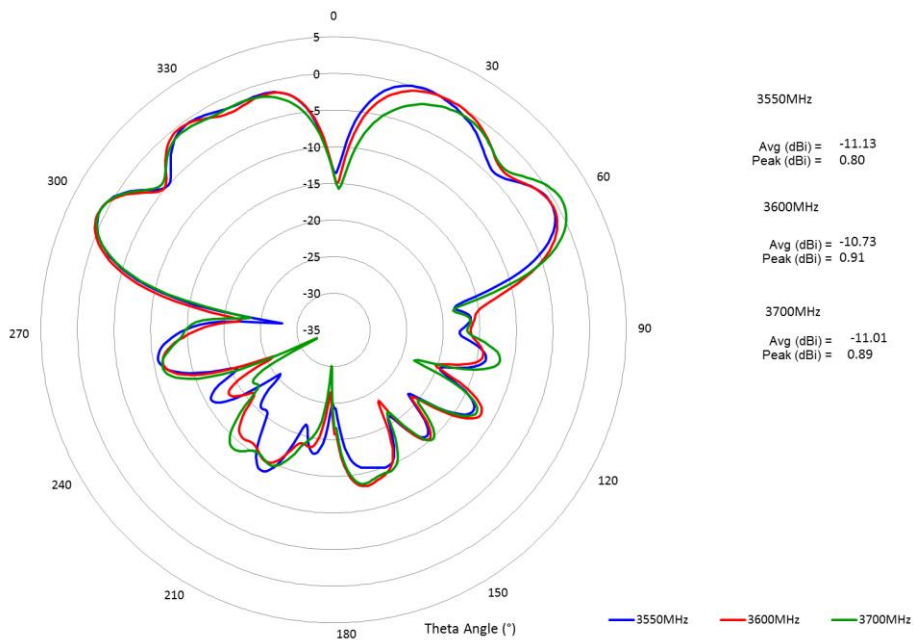

Issue: 1802

In the effort to improve our products, we reserve the right to make changes judged to be necessary.

CONFIDENTIAL AND PROPRIETARY INFORMATION

This document contains confidential and proprietary information of Pulse Electronics, Inc. (Pulse) and is protected by copyright, trade secret and other state and federal laws. Its receipt or possession does not convey any rights to reproduce, disclose its contents, or to manufacture, use or sell anything it may describe. Reproduction, disclosure or use without specific written authorization of Pulse is strictly forbidden.

Description: LTE 698-3800MHz Outdoor
Omni Antenna

Series: Low Profile Transit

PART NUMBER: LPT698/3800XXXX

PACKAGING

1PCS/ Foam bag
12PCS/ Carton box



Issue: 1802

In the effort to improve our products, we reserve the right to make changes judged to be necessary.

CONFIDENTIAL AND PROPRIETARY INFORMATION

This document contains confidential and proprietary information of Pulse Electronics, Inc. (Pulse) and is protected by copyright, trade secret and other state and federal laws. Its receipt or possession does not convey any rights to reproduce, disclose its contents, or to manufacture, use or sell anything it may describe. Reproduction, disclosure or use without specific written authorization of Pulse is strictly forbidden.