

Data sheet | Item number: 850-836

IP65 enclosure; Polyester (RAL 7032); WxHxD (324x100x164 mm); 4 x M20,
8 x M16, 17 x M12 cable grip

www.wago.com/850-836

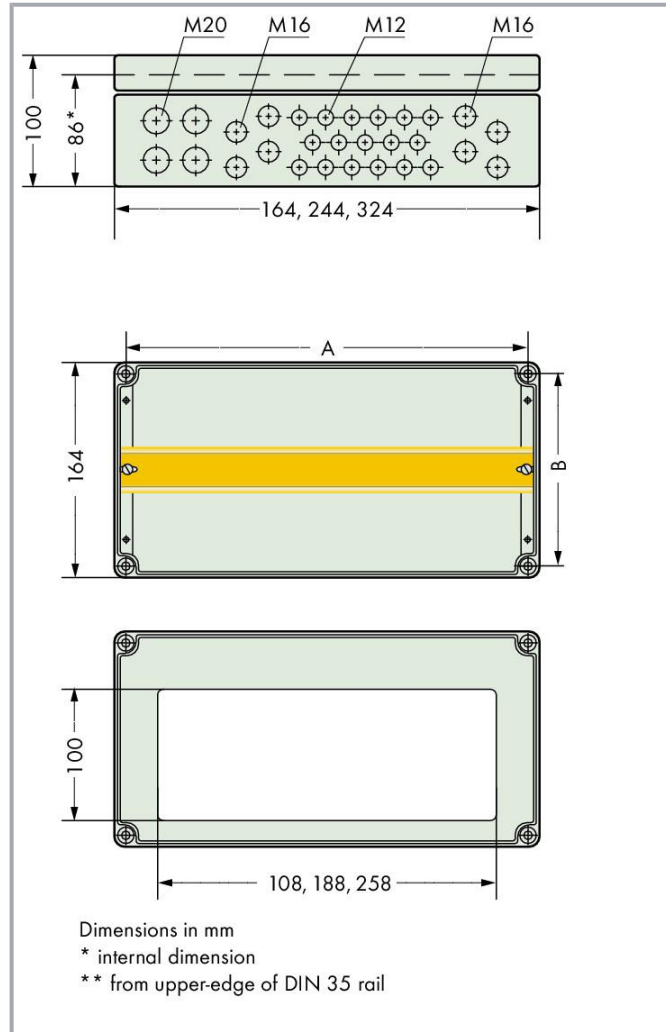

Item description

Included:

- Polyester enclosure, glass-fiber-reinforced, halogen-free, as V0 version (self-extinguishing)
- Polyamide cover screws, captive
- Inspection glass, incl. attachment panel for customer marking (marking not included in scope of supply)
- Mounting holes (4 mounting channels located outside the sealed enclosure)

Subject to changes. Please also observe the further product documentation!

WAGO GmbH & Co. KG
Hansastr. 27
32423 Minden
Phone: +49571 887-0 | Fax: +49571 887-169
Email: info.de@wago.com | Web: www.wago.com

Do you have any questions about our products?
We are always happy to take your call at +49 (571) 887-44222.



- Metric cable grips (polyamide PA 6), incl. filler plugs
 - M12 cable grip, cable diameter 3 ... 6 mm
 - M16 cable grip, cable diameter 5 ... 9 mm
 - M20 cable grip, cable diameter 9 ... 13 mm
- 1 x DIN-35/7.5 rail
- Oil and petroleum-resistant neoprene round cord seal
- Pebble gray, RAL 7032

The "number of I/O modules" also takes fieldbus couplers and bus end modules into account.

This applies to 12 mm wide I/O modules. 24 mm wide I/O modules count as two I/O modules.

Data

Technical data

Number of I/O modules	18
-----------------------	----

Physical data

Width	324 mm / 12.756 inches
Height	100 mm / 3.937 inches
Depth	164 mm / 6.457 inches
Panel cutout (W x H)	(302 x 142) mm

Mechanical Data

Cable bushings (number)	17
Cable bushings (type)	M12 (3 ... 6 mm cable diameter)
Cable bushings (number) (2)	8
Cable bushings (type) (2)	M16 (5 ... 9 mm cable diameter)
Cable bushings (number) (3)	4
Cable bushings (type) (3)	M20 (9 ... 13 mm cable diameter)

Material Data

Weight	2090.9 g
--------	----------

Environmental requirements

Protection type	IP65
-----------------	------

Subject to changes. Please also observe the further product documentation!

Commercial data

Product Group	15 (I/O System)
eCl@ss 10.0	27-14-24-18
eCl@ss 9.0	27-14-24-18
ETIM 8.0	EC000262
ETIM 7.0	EC000262
PU (SPU)	1 pcs
Packaging type	box
Country of origin	DE
GTIN	4017332819633
Customs tariff number	8538100000

Environmental Product Compliance

RoHS Compliance Status	Compliant, No Exemption
------------------------	-------------------------

Optional accessories

Mounting

Mounting accessories



Item no.: 850-903

Pole mounting; 4 clamping brackets; 2 molded rails and 4 clamping profiles in sheet steel; 2 tightening straps in stainless steel www.wago.com/850-903

Downloads

Documentation

Bid Text

850-836 X81 - Datei	2019 Feb 19	xml 4.6 kB	Download
850-836 doc - Datei	2017 Oct 9	doc 32.8 kB	Download

System Description

IP65 System Housing	pdf 115.7 kB	Download
---------------------	-----------------	----------

Subject to changes. Please also observe the further product documentation!

WAGO GmbH & Co. KG
 Hansastr. 27
 32423 Minden
 Phone: +49571 887-0 | Fax: +49571 887-169
 Email: info.de@wago.com | Web: www.wago.com

Do you have any questions about our products?
 We are always happy to take your call at +49 (571) 887-44222.



CAD/CAE-Data

CAE data

EPLAN Data Portal 850-836	URL	Download
WSCAD Universe 850-836	URL	Download

Environmental Product Compliance

Compliance Search

Environmental Product Compliance 850-836 IP65 enclosure; Polyester (RAL 7032); WxHxD (324x100x164 mm); 4 x M20, 8 x M16, 17 x M12 cable grip	URL	Download
--	---------------------	--------------------------

Installation Notes

Subject to changes. Please also observe the further product documentation!