

Q8 series

Ø8 mm panel mount LED indicators



DISTINCTIVE FEATURES

5 mm colored diffused epoxy lens or 5 mm water clear super bright LEDs

Prominent, recessed and flush bezel styles

(2.8 x 0.8) solder lug/faston terminals, pins or (200 mm long) wire terminations (2.0 x 0.5) solder lug/faston terminals on tri-color versions



ENVIRONMENTAL SPECIFICATIONS

- IP67 sealing option (EN60529)
- Operating & Storage Temperature Range:
Rear plastic body: -30 °C to +65 °C (-22 °F to +149 °F)
Rear epoxy body: -40 °C to +85 °C (-40 °F to +185 °F)



GENERAL SPECIFICATIONS

- Max Reverse Voltage: 5 V
- Viewing Angle: 30–100° (dependant on model)
- Life Expectancy: 100,000 hours
- Torque: 20 to 25 cNm
- Maximum panel thickness 7 mm
- Insulation resistance : 4,000 MΩ at 500 VDC



MATERIALS

- Plated brass bezel finished in bright chrome, black or satin grey and molded polycarbonate rear body
- Stainless Steel 316L bezel in flush version only



MOUNTING

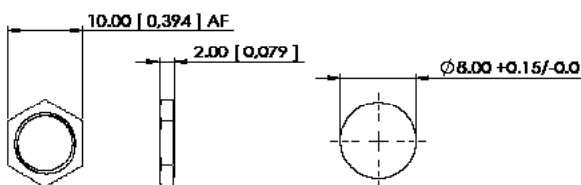

The company reserves the right to change specifications without notice.

All LED characteristics are dependent upon environmental conditions. Therefore published data should be considered nominal and subject to variations.



Q8 series

Ø8 mm panel mount LED indicators



ELECTRICAL SPECIFICATIONS

STANDARD LED INTENSITY

LED COMPONENT SPECIFICATIONS			
	Prominent and Recessed	Flush	Forward Voltage
HE Red	80 mcd	8 mcd	2.0 V
Green	60 mcd	6 mcd	2.2 V
Yellow	50 mcd	6 mcd	2.1 V
Blue	1,600 mcd	150 mcd	3.3 V
White	1,600 mcd	500 mcd	3.3 V
Orange	60 mcd	110 mcd	2.2 V
Bi-color (Typical) (Red/Green)	14/30 mcd	15/10 mcd	2.0V/2.2 V
Tri-color (Typical) (Red/Green/Yellow)	Red: 150 mcd Green: 100 mcd	15/10/6 mcd	Red: 2.1 V Green: 2.1 V

Bi-color - The color is changed by reversing the polarity of the supply voltage.
Tri-color - The indicator has red and green LEDs, when both connected yellow is produced.

SUPER BRIGHT LED INTENSITY

LED COMPONENT SPECIFICATIONS			
	Prominent and Recessed	Flush	Forward Voltage
HE Red	5,000 mcd	1,300 mcd	2.2 V
Green	10,000 mcd	3,000 mcd	3.3 V
Yellow	4,000 mcd	1120 mcd	2.1 V
Blue	2,200 mcd	280 mcd	3.3 V
White	2,500 mcd	1560 mcd	3.3 V
Orange	4,000 mcd	500 mcd	2.2 V

HYPER BRIGHT LED INTENSITY

LED COMPONENT SPECIFICATIONS			
	Prominent and Recessed	Flush	Forward Voltage
HE Red	6,000 mcd	980 mcd	2.2 V
Green	1,900 mcd	750 mcd	3.3 V
Yellow	1,600 mcd	1560 mcd	2.0 V
Orange	2,400 mcd	110 mcd	2.2 V

- The operating voltage must not be exceeded by more than 10% as this will result in reduced life expectancy
- Luminous intensity is measured at 20 mA on a discrete led unless otherwise stated.
- Luminous intensities and color shades of white LEDs may vary within a batch.
- Luminous intensity will be reduced with lower operating current.

Voltage	Operating Voltage	Operating Current
	(Min to Max)	(Typical All Types)
02 (No Resistor)*	1.8 to 3.3 VDC	20 mA max
6 VDC	5.4 to 6.6 VDC	20 mA
12 VDC	10.8 to 13.2 VDC	20 mA
24 VDC	21.6 to 26.4 VDC	20 mA
28 VDC	25.2 to 30.8 VDC	20 mA
110 VAC	99 to 121 VAC	6 mA
220 VAC	207 to 235 VAC	3 mA

* Customer to supply resistor for desired operating current.

ADDITIONAL INFORMATION ON LED COMPONENTS

- Recommended usage:
 - Standard: Homogenous light output that is good for indoor applications.
 - Hyper Bright: Homogenous light output that is good for outside viewing and is daylight visible.
 - Super Bright: A water clear LED that is good for long distance viewing and is daylight visible.



BUILD YOUR PART NUMBER

<div style="border: 1px solid black; padding: 2px; width: 30px; margin: 0 auto;">Q</div> <p>.....</p> <p>SERIES</p>	<div style="border: 1px solid black; padding: 2px; width: 30px; margin: 0 auto;">8</div> <p>.....</p> <p>MOUNTING HOLE</p>	<div style="border: 1px solid black; padding: 2px; width: 30px; margin: 0 auto;">P</div> <p>.....</p> <p>BEZEL STYLE</p>	<div style="border: 1px solid black; padding: 2px; width: 30px; margin: 0 auto;">1</div> <p>.....</p> <p>TERMINALS</p>	<div style="border: 1px solid black; padding: 2px; width: 30px; margin: 0 auto;">C</div> <p>.....</p> <p>BEZEL FINISH</p>	
	<p>8 Ø8 mm</p>	<p>P Prominent</p> <p>R Recessed</p> <p>F Flush</p>	<p>1 Solder Lug/ Fastons (2.8 x 0.8)</p> <p>2 Pins</p> <p>3 Wires</p> <p>4 Rear epoxy Pins</p>	<p>5 Rear epoxy Wires</p> <p>6 Short body Pins</p> <p>7 Short body Wires</p> <p>8 Short body Lug/ Fastons (2.8 x 0.8)</p> <p>9 Extended short body solder Lug/ Fastons (2.8 x 0.5)</p>	<p>C Bright Chrome</p> <p>B Black</p> <p>G Satin Grey</p> <p>S Stainless Steel 316L*</p> <p><small>*Flush version only</small></p>
<div style="border: 1px solid black; padding: 2px; width: 30px; margin: 0 auto;">XX</div> <p>.....</p> <p>TYPE OF ILLUMINATION</p>	<div style="border: 1px solid black; padding: 2px; width: 30px; margin: 0 auto;">R</div> <p>.....</p> <p>LED COLOR</p>	<div style="border: 1px solid black; padding: 2px; width: 30px; margin: 0 auto;">HG</div> <p>.....</p> <p>LED COLOR</p>	<div style="border: 1px solid black; padding: 2px; width: 30px; margin: 0 auto;">SW</div> <p>.....</p> <p>VOLTAGE</p>	<div style="border: 1px solid black; padding: 2px; width: 30px; margin: 0 auto;">(Blank)</div> <p>.....</p> <p>SEALING</p>	
<p>XX Fixed Light</p> <p>KK Flashing Light (12V – 28VDC)</p> <p>YY Bi-color</p> <p>ZZ Tri-color</p>	<p>R Red</p> <p>G Green</p> <p>Y Yellow</p> <p>B Blue</p> <p>W White</p> <p>O Orange</p> <p>HR Hyper Bright Red</p>	<p>HG Hyper Bright Green</p> <p>HY Hyper Bright Yellow</p> <p>HO Hyper Bright Orange</p> <p>SR Super Bright Red</p> <p>SG Super Bright Green</p> <p>SY Super Bright Yellow</p> <p>SB Super Bright Blue</p>	<p>SW Super Bright White</p> <p>SO Super Bright Orange</p> <p>RG Red/Green</p> <p>RY Red/Yellow</p> <p>GY Green/Yellow</p> <p>RYG Red/Yellow/Green</p>	<p>02 no resistor*</p> <p>06 6 VDC</p> <p>12 12 VDC</p> <p>12A 12 VAC/DC</p> <p>24 24 VDC</p> <p>24A 24 VAC/DC</p> <p>28 28 VDC</p> <p>28A 28 VAC/DC</p> <p>110 110 VAC</p> <p>220 220 VAC</p> <p><small>* please refer to the forward voltage in electrical specifications</small></p>	<p>(Blank) Unsealed</p> <p>E IP67</p>



ABOUT THIS SERIES

- Notice:** please note that not all combinations of above numbers are available.
- Gold faston terminal denotes anode (+), silver terminal denotes cathode (-)
 - Standard and Bi-Colour are provided in Standard wire length is 200mm, 24AWG UL1061, Red wire denotes anode (+), Black wire denotes cathode (-) for other lengths consult APEM.
 - 110 VAC and 220 VAC, only available with terminal options 1, 3 and 5
 - Terminal options 2,4,6,8 & 9 are only available without integral resistor. Tri-color not available with terminal 9
 - Bi-color leds, by connecting the gold faston (+) one color is produced, by reversing the supply voltage another color is produced – bi-colors are available up to 28 VDC [AC products not available]
 - Take care when soldering to the faston terminals (recommended solder temperature 300 °C - 3 sec)
 - We recommend using hyperbright or superbright leds for use at 110 VAC and 220 VAC
 - Mains voltage product is not recommended for use on 3 phase appliances
 - The tri-color led has red and green leds when both are connected yellow is produced
 - Standard tri-color faston terminals are two anodes (+) and one cathode (-)
 - Tri-color wires are one red (+) and one green (+) anode and one black (-) cathode
 - Tri-color pins are center (-) cathode, shortest (+) anode pin green, longest (+) anode pin red

Q8 series

Ø8 mm panel mount LED indicators

PROMINENT BEZEL



WIRES

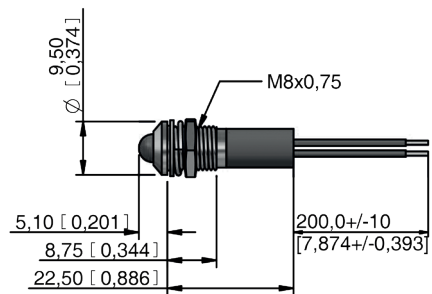

REAR EPOXY WIRES

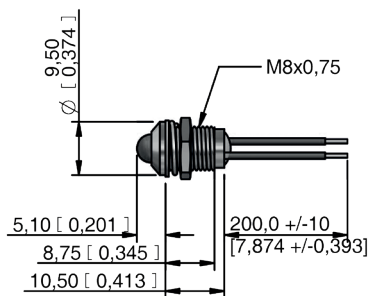

SHORT BODY WIRES

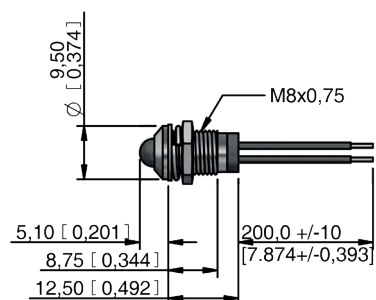

SOLDER LUG/FASTON

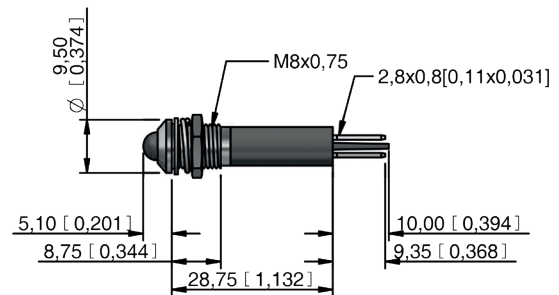

PINS

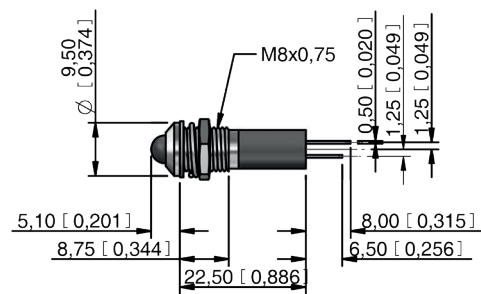

REAR EPOXY PINS

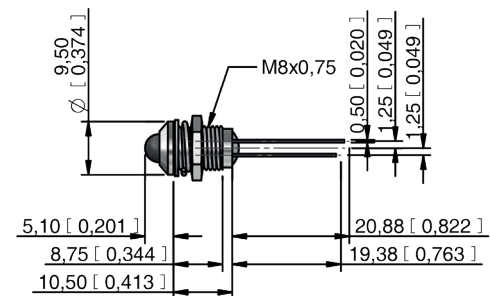

SHORT BODY PINS

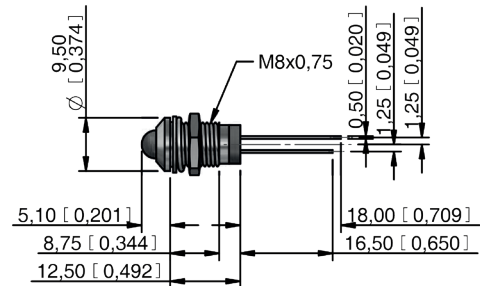

PROMINENT BEZEL (CONTINUED) SHORT BODY SOLDER LUG/FASTONS

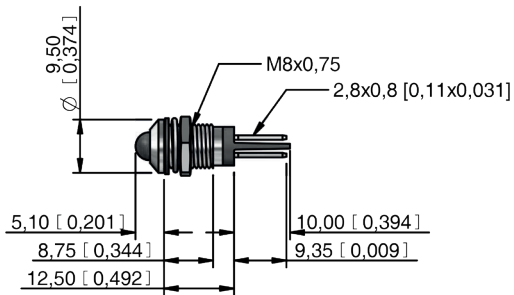

EXTENDED SHORT BODY SOLDER LUG/FASTONS

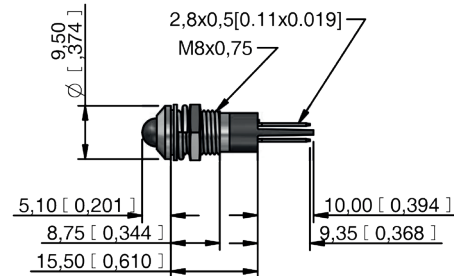

SHORT BODY PIN (TRI COLOR)

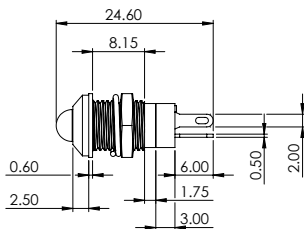

FLUSH BEZEL



SOLDER LUG/FASTON

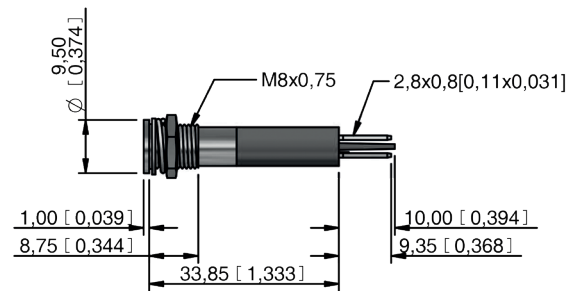

WIRES

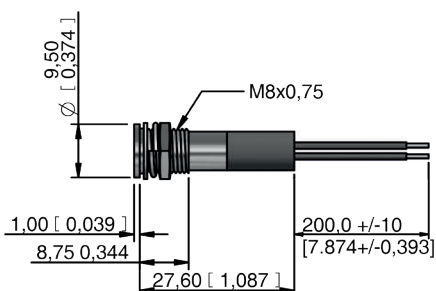

PINS

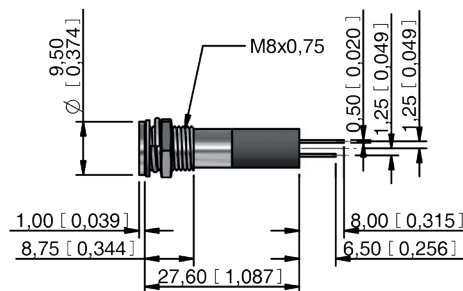

Q8 series

Ø8 mm panel mount LED indicators

FLUSH BEZEL (CONTINUED)

REAR EPOXY WIRES

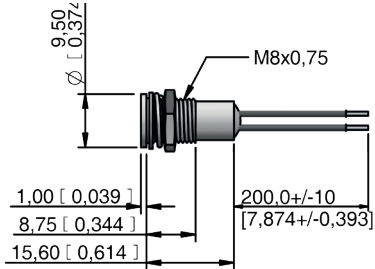

REAR EPOXY PINS

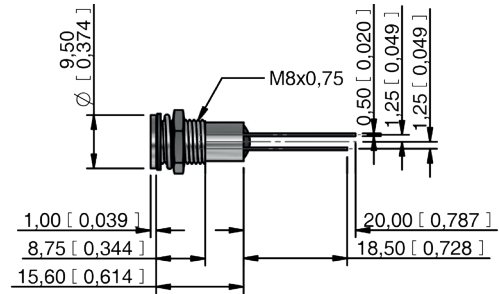

SHORT BODY WIRES

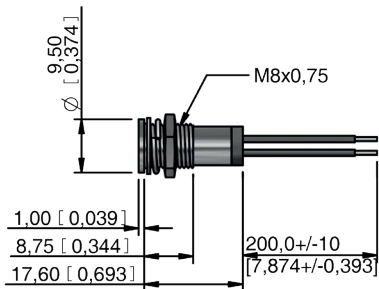

SHORT BODY PINS

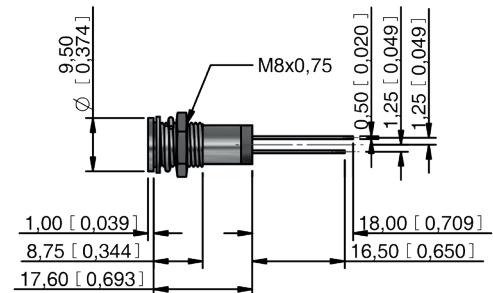

SHORT BODY SOLDER LUG/FASTONS

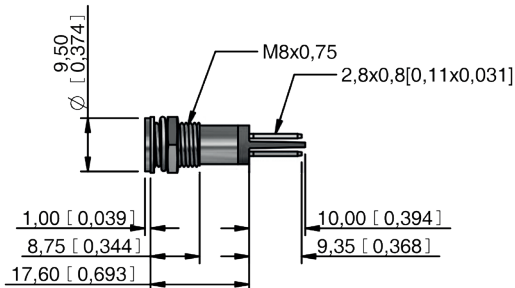

EXTENDED SHORT BODY SOLDER LUG/FASTONS

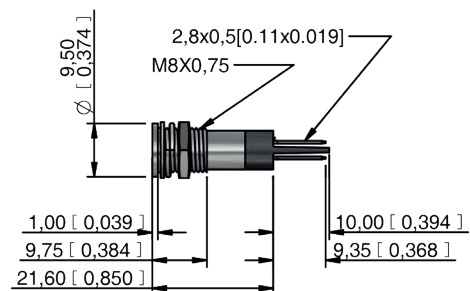

SHORT BODY PIN (TRI COLOR)

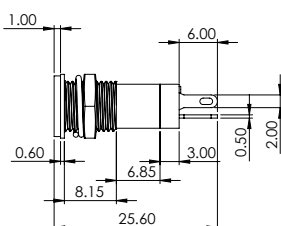

RECESSED BEZEL



WIRES

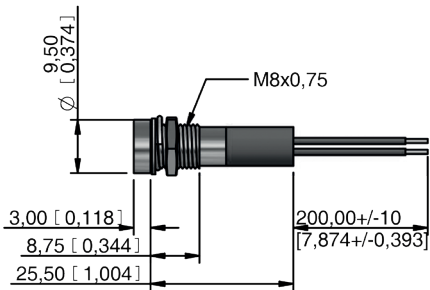

REAR EPOXY WIRES

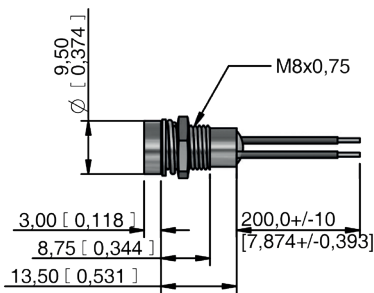

SHORT BODY WIRES

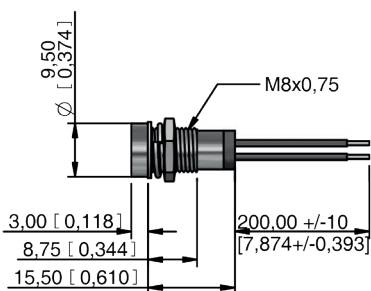

SOLDER LUG/FASTON

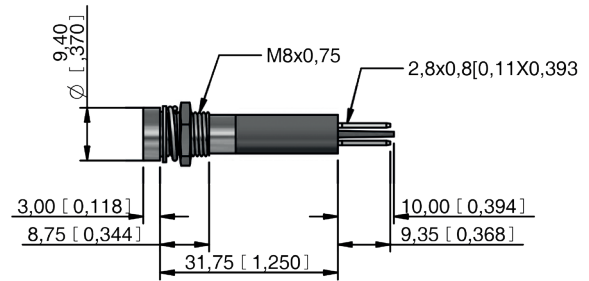

PINS

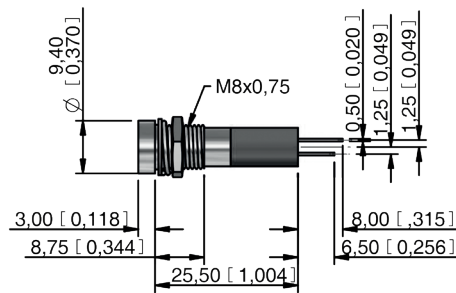

REAR EPOXY PINS

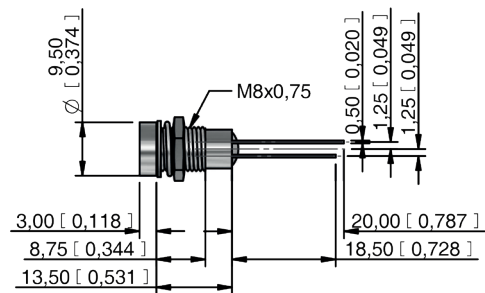

SHORT BODY PINS

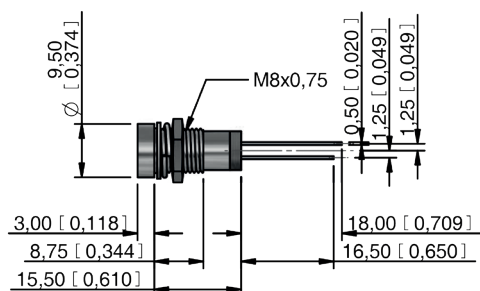

Q8 series

Ø8 mm panel mount LED indicators

RECESSED BEZEL (CONTINUED)

SHORT BODY SOLDER LUG/FASTONS

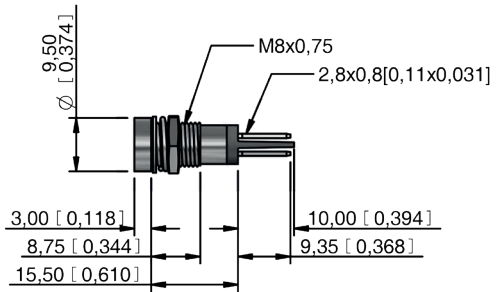

EXTENDED SHORT BODY SOLDER LUG/FASTONS

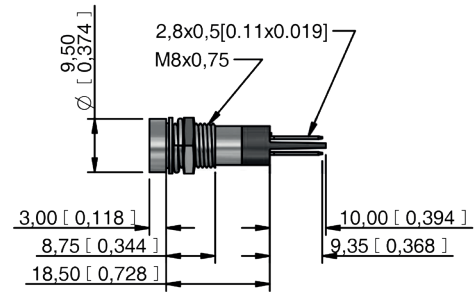

SHORT BODY PIN (TRI COLOR)

