



# SIOV Metal Oxide Varistors

SMD high surge series

**Series/Type:** V14K\*\*, H14K\*\*  
**Ordering code:** B72214M\*\*\*K00\*  
**Date:** 2023-01-16  
**Version:** 1

**Preliminary data**
**Features**

- Suitable for Surface Mount Device assembly
- AEC-Q200 qualified
- Optional for vertical version or horizontal version

**Applications**

Overvoltage protection, especially on-board chargers

**SIOV nomenclature**

V(H)	Vertical version or horizontal version
14	Rated disk dimension
K	Tolerance of $V_V$ at 1mA: $\pm 10\%$
175 – 460	Max. AC operating voltage
*	Optional, typical design of customer

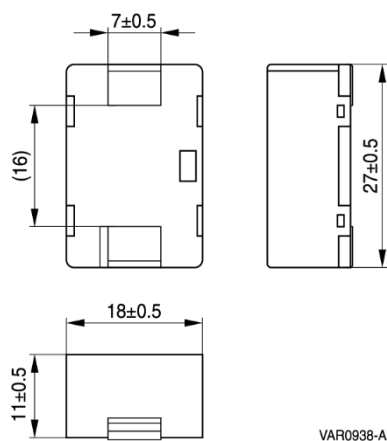
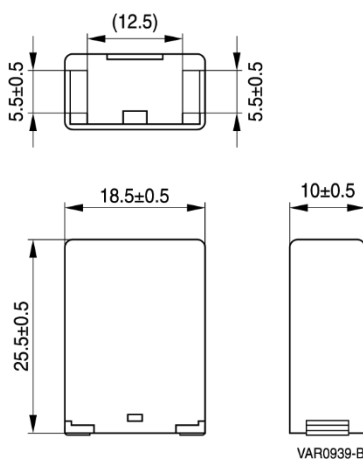
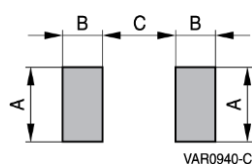
**Dimensional drawings in mm**
**Horizontal version**

**Vertical version**

**Recommended solder pad layout in mm**

Type	A	B	C
V14K**	8.5	5.3	9.9
H14K**	10.0	7.5	14.0

**Preliminary data**
**Electrical specifications and ordering codes**

 Maximum ratings ( $T_A = 125\text{ °C}$ )

Type	Ordering code	$V_{RMS}$ V	$V_{DC}$ V
V14K175	<u>B72214M171K000</u>	175	225
H14K175	<u>B72214M171K001</u>	175	225
V14K210	<u>B72214M211K000</u>	210	270
H14K210	<u>B72214M211K001</u>	210	270
V14K230	<u>B72214M231K000</u>	230	300
H14K230	<u>B72214M231K001</u>	230	300
V14K250	<u>B72214M251K000</u>	250	320
H14K250	<u>B72214M251K001</u>	250	320
V14K275	<u>B72214M271K000</u>	275	350
H14K275	<u>B72214M271K001</u>	275	350
V14K300	<u>B72214M301K000</u>	300	385
H14K300	<u>B72214M301K001</u>	300	385
V14K320	<u>B72214M321K000</u>	320	420
H14K320	<u>B72214M321K001</u>	320	420
V14K350	<u>B72214M351K000</u>	350	460
H14K350	<u>B72214M351K001</u>	350	460
V14K385	<u>B72214M381K000</u>	385	505
H14K385	<u>B72214M381K001</u>	385	505
V14K420	<u>B72214M421K000</u>	420	560
H14K420	<u>B72214M421K001</u>	420	560
V14K460	<u>B72214M461K000</u>	460	615
H14K460	<u>B72214M461K001</u>	460	615

**Preliminary data**
**Characteristics (T<sub>A</sub> = 25 °C)**

Type	I <sub>max</sub> (8/20 μs) 1 time A	I <sub>n</sub> <sup>1)</sup> (8/20 μs) 15 times A	W <sub>max</sub> (2 ms) J	P <sub>max</sub> W	V <sub>v</sub> (1 mA) V ±10%	V <sub>c,max</sub> (i <sub>c</sub> =35A) V	C <sub>typ</sub> (1 kHz) pF
V14K175	10000	5000	100.0	0.80	270	455	1150
H14K175	10000	5000	100.0	0.80	270	455	1150
V14K210	10000	5000	115.0	0.80	330	545	870
H14K210	10000	5000	115.0	0.80	330	545	870
V14K230	10000	5000	130.0	0.80	360	595	820
H14K230	10000	5000	130.0	0.80	360	595	820
V14K250	10000	5000	140.0	0.80	390	650	760
H14K250	10000	5000	140.0	0.80	390	650	760
V14K275	10000	5000	150.0	0.80	430	710	700
H14K275	10000	5000	150.0	0.80	430	710	700
V14K300	10000	5000	175.0	0.80	470	775	650
H14K300	10000	5000	175.0	0.80	470	775	650
V14K320	10000	5000	185.0	0.80	510	840	600
H14K320	10000	5000	185.0	0.80	510	840	600
V14K350	10000	5000	200.0	0.80	560	910	550
H14K350	10000	5000	200.0	0.80	560	910	550
V14K385	10000	5000	225.0	0.80	620	1025	500
H14K385	10000	5000	225.0	0.80	620	1025	500
V14K420	10000	5000	245.0	0.80	680	1120	460
H14K420	10000	5000	245.0	0.80	680	1120	460
V14K460	10000	5000	270.0	0.80	750	1240	440
H14K460	10000	5000	270.0	0.80	750	1240	440

**1) Note:** Nominal discharge current I<sub>n</sub> according to UL 1449, 4<sup>th</sup> edition.

**General technical data**

Climatic category	to IEC 60068-1	40/125/56
Operating temperature	to IEC 61051	-40 ... +125 °C
Storage temperature		-40 ... +150 °C
Electric strength	to IEC 61051	≥ 2.5 kV <sub>RMS</sub>
Insulation resistance	to IEC 61051	≥ 100 MΩ

Preliminary data

Packaging

Horizontal version

- Standard packaging is in trays
- Quantity per tray: 45 pcs
- Quantity per box: 135 pcs

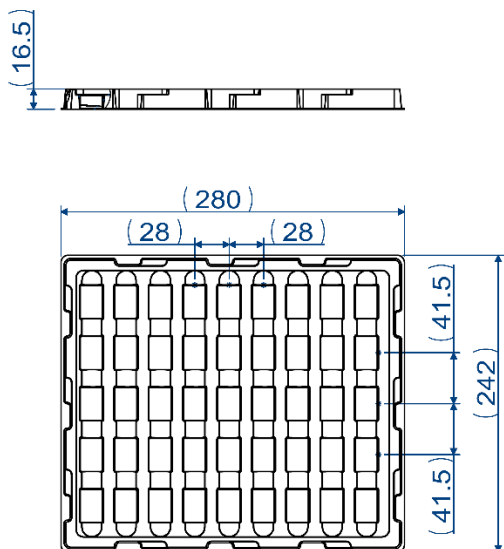

Vertical version

- Standard packaging is in trays
- Quantity per tray: 100 pcs
- Quantity per box: 200 pcs

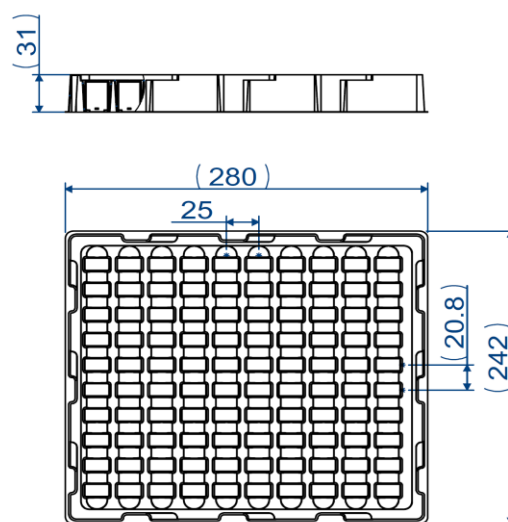

( ) means reference dimensions

Unit: mm

Preliminary data

V/I characteristics

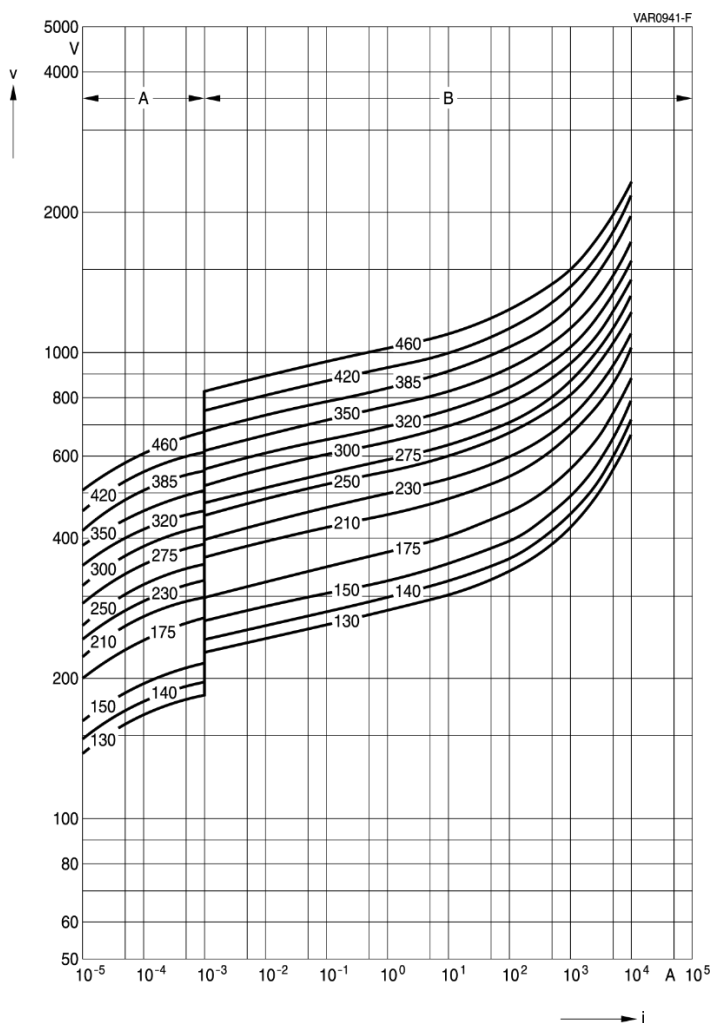

Derating curves

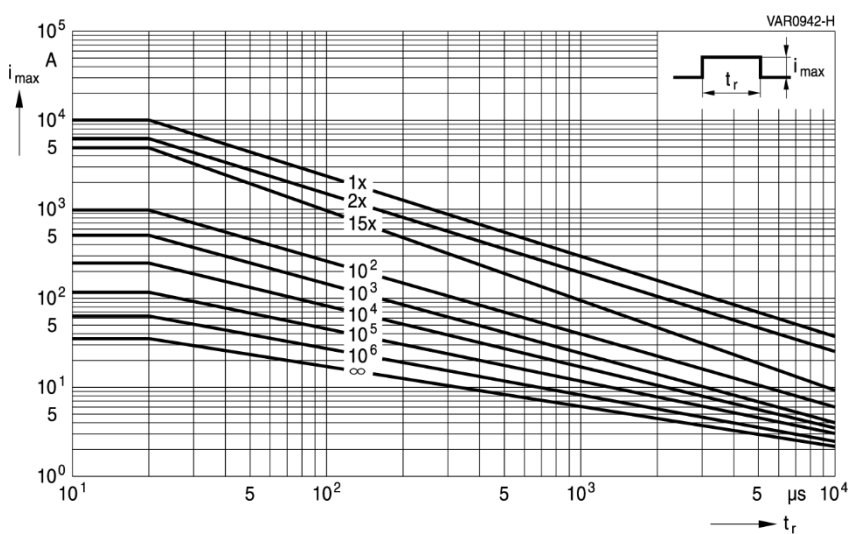

**Preliminary data**
**Electrical reliability data**

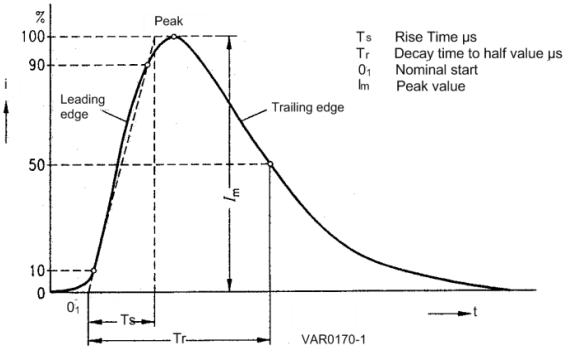
Characteristics	Test methods/description	Specifications
Varistor voltage	The voltage between two terminals with the specified measuring current applied is called $V_V$ (1 mA <sub>DC</sub> @ 0.2 ... 2 s).	To meet the specified value
Clamping voltage	The maximum voltage between two terminals with the specified standard impulse current (8/20 $\mu$ s) illustrated below applied.  	To meet the specified value
Surge current derating, 8/20 $\mu$ s	10 surge currents (8/20 $\mu$ s), unipolar, interval 30 s, amplitude corresponding to derating curve for 10 impulses at 20 $\mu$ s	$ \Delta V / V (1 \text{ mA})  \leq 10\%$ (measured in direction of surge current) No visible damage
Surge current derating, 2 ms	10 surge currents (2 ms), unipolar, interval 120 s, amplitude corresponding to derating curve for 10 impulses at 2 ms	$ \Delta V / V (1 \text{ mA})  \leq 10\%$ (measured in direction of surge current) No visible damage

**Preliminary data**
**Mechanical reliability data**

<b>Characteristics</b>	<b>Test methods/description</b>	<b>Specifications</b>
Vibration	MIL-STD-202 method 204 5 g for 20 min., 12 cycles each of 3 orientations Test from 10 – 2000 Hz	$ \Delta V / V (1 \text{ mA})  \leq 5\%$ No visible damage
Solderability	IEC 60068-2-58, test Td1, method 1 Solder bath, Sn96.5Ag3Cu0.5 T = 245 ± 3 °C t = 2 s	The terminations shall be uniformly tinned for soldering test.
Resistance to soldering heat	IEC60068-2-58, test Td2, method 1 Solder bath, Sn96.5Ag3Cu0.5 T = 260 ± 5 °C D = 10 ± 1 s	$ \Delta V / V (1 \text{ mA})  \leq 5\%$ No visible damage
Board flex	AEC Q200-005 60 seconds minimum holding time	$ \Delta V / V (1 \text{ mA})  \leq 5\%$ No visible damage
Electric strength	IEC 61051-1, test 4.9.2 Metal balls method, 2500 VRMS, 60 s The varistor is placed in a container holding 1.6 ± 0.2 mm diameter metal balls such that only the terminations of the varistor are protruding. The specified voltage shall be applied between both terminals of the specimen connected together and the electrode inserted between the metal balls.	No breakdown



**Preliminary data**
**Environmental reliability data**

Characteristics	Test methods/description	Specifications
Max. DC operating voltage	MIL-STD-202F, method 108A, UCT, $V_{DC}$ , 1000 h	$ \Delta V / V (1 \text{ mA})  \leq 10\%$ No visible damage
Damp heat, steady state	IEC 60068-2-67, test Cy, 85 °C, 85% r. H., $0.85 * V_v (1\text{mA})$ , 1000 h	$ \Delta V / V (1 \text{ mA})  \leq 10\%$ No visible damage
Climatic sequence	The specimen shall be subjected to: a) IEC 60068-2-2, test Ba, dry heat at UCT, 16 h b) IEC 60068-2-30, test Db, damp heat, 1st cycle: 55 °C, 93% r.H., 24 h c) IEC 60068-2-1, test Aa, cold, LCT, 2 h d) IEC 60068-2-30, test Db, damp heat, additional 5 cycles: 55 °C/25 °C, 93% r.H., 24 h/cycle  Then the specimen shall be stored at room temperature and normal humidity for 1 to 2 h. Thereafter, the change of $V_v$ shall be measured. Thereafter, insulation resistance $R_{ins}$ shall be measured at $V = 500 \text{ V}$ .	$ \Delta V / V (1 \text{ mA})  \leq 10\%$ $R_{ins} \geq 100 \text{ M}\Omega$
Rapid change of temperature	IEC 60068-2-14, test Na, LCT/UCT, dwell time 10 min., 1000 cycles	$ \Delta V / V (1 \text{ mA})  \leq 5\%$ No visible damage

**Note:**

UCT = Upper category temperature

LCT = Lower category temperature

 $R_{ins}$  = Insulation resistance

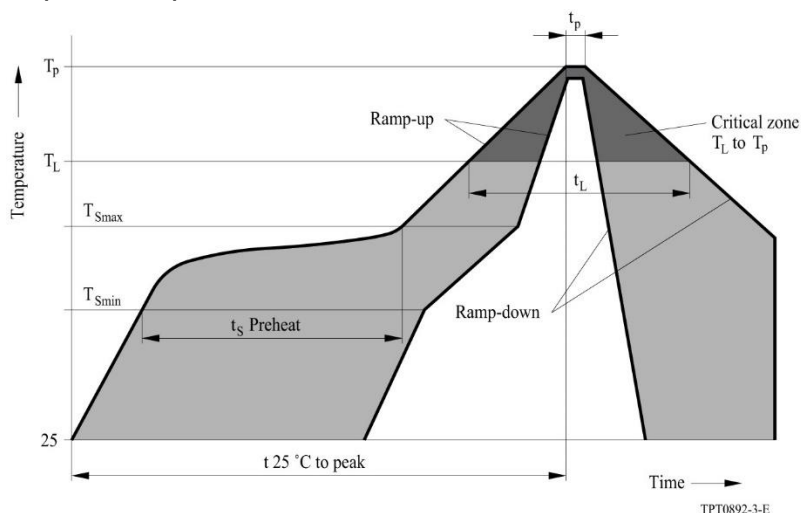
**Preliminary data**
**Recommended soldering temperature profiles**
**Reflow soldering temperature profile**

Profile feature	Sn-Pb eutectic assembly	Pb-free assembly
Average ramp-up rate ( $T_{Smax}$ to $T_P$ )	3 °C/s max	3 °C/s max
Preheat <ul style="list-style-type: none"> <li>▪ Minimum temperature (<math>T_{Smin}</math>)</li> <li>▪ Maximum temperature (<math>T_{Smax}</math>)</li> <li>▪ Time (<math>t_{Smin}</math> to <math>t_{Smax}</math>)</li> </ul>	100 °C 150 °C 60 ... 120 s	150 °C 200 °C 60...180 s
Time maintained above <ul style="list-style-type: none"> <li>▪ Minimum temperature (<math>T_L</math>)</li> <li>▪ Time (<math>t_L</math>)</li> </ul>	183 °C 60 ... 150 s	217 °C 60 ... 150 s
Peak classification temperature ( $T_P$ )	220 °C ... 240 °C	240 °C ... 260 °C
Time within 5 °C of actual peak temperature ( $t_p$ )	10 ... 30 s	20 ... 40 s
Ramp-down rate	6 °C/s max	6 °C/s max
Time 25 °C to peak temperature	6 min. max	8 min. max

**Note:** All temperatures refer to topside of the package, measured on the package body surface.  
Maximum number of reflow cycles: 3

**Soldering guidelines**

The usage of mild, non-activated fluxes for soldering is recommended, as well as proper cleaning of the PCB.

## Preliminary data

## Cautions and warnings

### General

1. TDK Electronics' metal oxide varistors (SIOVs) are designed for specific applications and should not be used for purposes not identified in our specifications, application notes and data books unless otherwise agreed with TDK Electronics during the design-in phase.
2. Ensure suitability of SIOVs through reliability testing during the design-in phase. The SIOVs should be evaluated taking into consideration worst-case conditions.
3. For applications of SIOVs in line-to-ground circuits based on various international and local standards restrictions exist or additional safety measures are required.

### Storage

1. Store SIOVs only in original packaging. Do not open the package prior to processing.
2. Recommended storage conditions in original packaging:
  - Storage temperature: -25 °C ... +45 °C
  - Relative humidity: < 75% annual average, < 95% on maximum 30 days a year
  - Dew precipitation is to be avoided.
3. Avoid contamination of the SIOVs during storage, handling, and processing.
4. Avoid storage of SIOVs in harmful environments that can affect the function during long-term operation (examples given under operation precautions).
5. The SIOV type series should be soldered after shipment from TDK Electronics within the time specified:
  - SIOV-S, -Q, -LS, -B, -SNF: 24 months
  - ETFV / T series, -CU: 12 months

### Handling

1. SIOVs must not be dropped.
2. Components must not be touched with bare hands. Gloves are recommended.
3. Avoid contamination of the surface of SIOV electrodes during handling, be careful of the sharp edge of the SIOV's electrodes.

### Preliminary data

#### Soldering (where applicable)

1. Use rosin-type flux or non-activated flux.
2. Insufficient preheating may cause ceramic cracks.
3. Rapid cooling by dipping in solvent is not recommended.
4. Complete removal of flux is recommended.
5. Temperatures of all preheat stages and the solder bath must be strictly controlled especially for T series (T14 and T20).

#### Mounting

1. Potting, sealing or adhesive compounds can produce chemical reactions in the SIOV ceramic that will degrade the component's electrical characteristics.
2. Overloading SIOVs may result in ruptured packages and expulsion of hot materials. For this reason, the SIOVs should be physically shielded from adjacent components.

#### Operation

1. Use SIOVs only within the specified temperature operating range
2. Use SIOVs only within the specified voltage and current ranges.
3. Environmental conditions must not harm the SIOVs. Use SIOVs only in normal atmospheric conditions. Avoid use in the presence of deoxidizing gases (chlorine gas, hydrogen sulfide gas, ammonia gas, sulfuric acid gas, etc.), corrosive agents, humid or salty conditions. Avoid contact with any liquids and solvents.

#### Display of ordering codes for TDK Electronics products

The ordering code for one and the same product can be represented differently in data sheets, data books, other publications, on the company website, or in order-related documents such as shipping notes, order confirmations and product labels. **The varying representations of the ordering codes are due to different processes employed and do not affect the specifications of the respective products.** Detailed information can be found on the Internet under [www.tdk-electronics.tdk.com/orderingcodes](http://www.tdk-electronics.tdk.com/orderingcodes).

## Important notes

The following applies to all products named in this publication:

1. Some parts of this publication contain **statements about the suitability of our products for certain areas of application**. These statements are based on our knowledge of typical requirements that are often placed on our products in the areas of application concerned. We nevertheless expressly point out **that such statements cannot be regarded as binding statements about the suitability of our products for a particular customer application**. As a rule we are either unfamiliar with individual customer applications or less familiar with them than the customers themselves. For these reasons, it is always ultimately incumbent on the customer to check and decide whether a product with the properties described in the product specification is suitable for use in a particular customer application.
2. We also point out that **in individual cases, a malfunction of electronic components or failure before the end of their usual service life cannot be completely ruled out in the current state of the art, even if they are operated as specified**. In customer applications requiring a very high level of operational safety and especially in customer applications in which the malfunction or failure of an electronic component could endanger human life or health (e.g. in accident prevention or life-saving systems), it must therefore be ensured by means of suitable design of the customer application or other action taken by the customer (e.g. installation of protective circuitry or redundancy) that no injury or damage is sustained by third parties in the event of malfunction or failure of an electronic component.
3. **The warnings, cautions and product-specific notes must be observed.**
4. In order to satisfy certain technical requirements, **some of the products described in this publication may contain substances subject to restrictions in certain jurisdictions (e.g. because they are classed as hazardous)**. Useful information on this will be found in our Material Data Sheets on the Internet ([www.tdk-electronics.tdk.com/material](http://www.tdk-electronics.tdk.com/material)). Should you have any more detailed questions, please contact our sales offices.
5. We constantly strive to improve our products. Consequently, **the products described in this publication may change from time to time**. The same is true of the corresponding product specifications. Please check therefore to what extent product descriptions and specifications contained in this publication are still applicable before or when you place an order.

We also **reserve the right to discontinue production and delivery of products**. Consequently, we cannot guarantee that all products named in this publication will always be available. The aforementioned does not apply in the case of individual agreements deviating from the foregoing for customer-specific products.

6. Unless otherwise agreed in individual contracts, **all orders are subject to our General Terms and Conditions of Supply**.
7. **Our manufacturing sites serving the automotive business apply the IATF 16949 standard**. The IATF certifications confirm our compliance with requirements regarding the quality management system in the automotive industry. Referring to customer requirements and customer specific requirements ("CSR") TDK always has and will continue to have the policy of respecting individual agreements. Even if IATF 16949 may appear to support the acceptance of unilateral requirements, we hereby like to emphasize that **only requirements mutually agreed upon can and will be implemented in our Quality Management System**. For clarification purposes we like to point out that obligations from IATF 16949 shall only become legally binding if individually agreed upon.

## Important notes

8. The trade names EPCOS, CarXield, CeraCharge, CeraDiode, CeraLink, CeraPad, CeraPlas, CSMP, CTVS, DeltaCap, DigiSiMic, ExoCore, FilterCap, FormFit, InsuGate, LeaXield, MiniBlue, MiniCell, MKD, MKK, ModCap, MotorCap, PCC, PhaseCap, PhaseCube, PhaseMod, PhiCap, PowerHap, PQSine, PQvar, SIFERRIT, SIFI, SIKOREL, SilverCap, SIMDAD, SiMic, SIMID, SineFormer, SIOV, ThermoFuse, WindCap, XieldCap are **trademarks registered or pending** in Europe and in other countries. Further information will be found on the Internet at [www.tdk-electronics.tdk.com/trademarks](http://www.tdk-electronics.tdk.com/trademarks).

Release 2022-07