

Schematic for the NCL30073LED1GEVB Evaluation Board

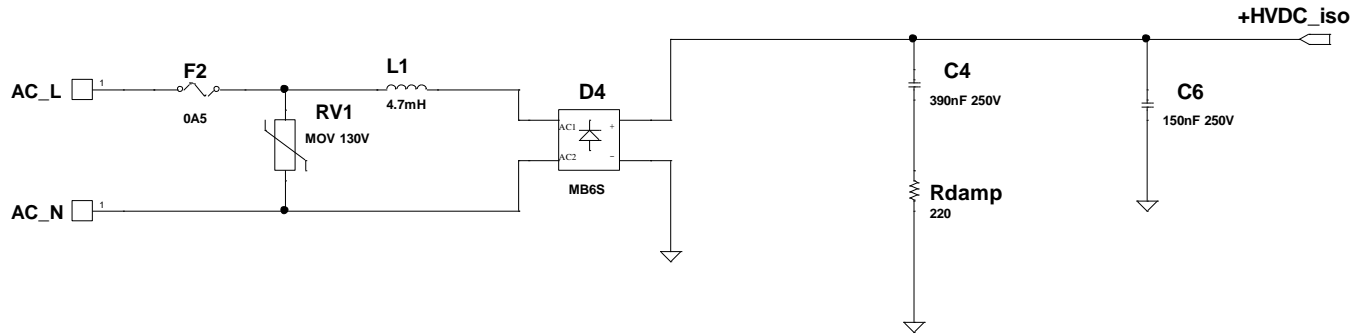

Figure 1. Input Circuit

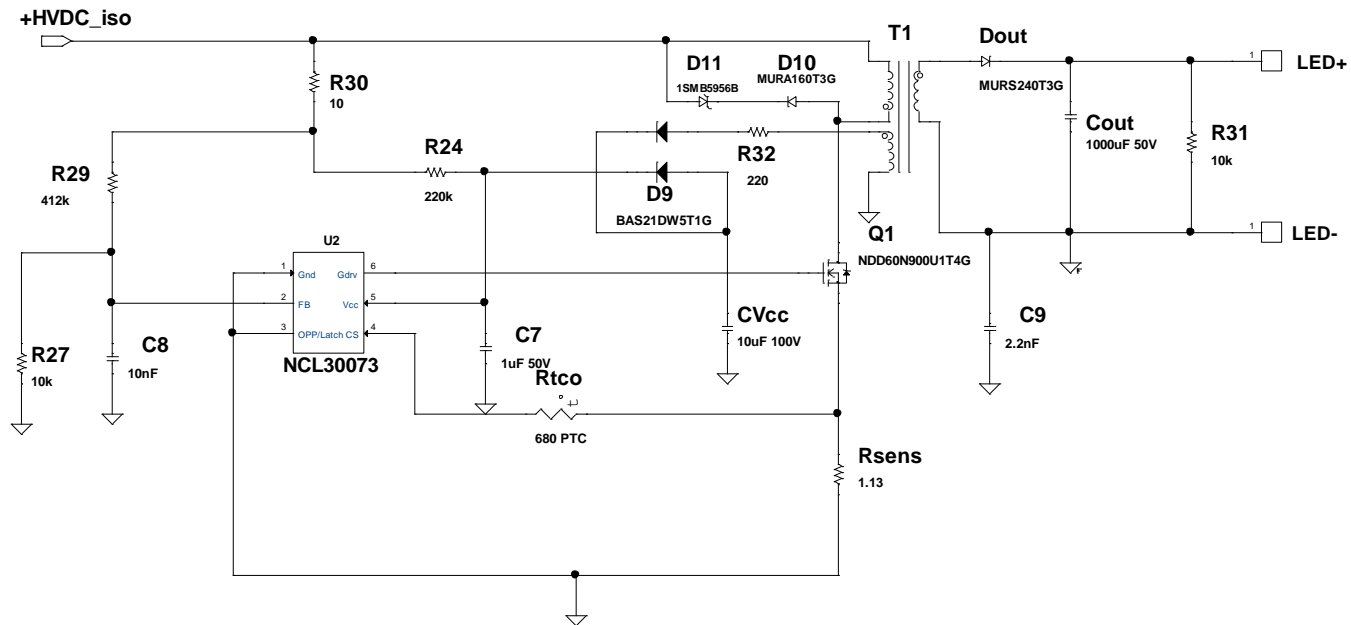

Figure 2. Main Schematic