



SPECIFICATIONS

Model	Stroke mm	Max Absorption Energy J(kgf·m)	Max Equivalent Mass kg (kgf)
FK-2016H-S	16	29.4(3.0)	25(25)

Max Drag N (kgf)	Max. Absorption Energy per min. J/min(kgf·m/min)	Extension Force N(kgf)	Mass g
3,528 (360)	343(35)	18.1(1.85) or lower	147

COMMON SPECIFICATIONS

Range of Impact Rate	m/s	0.3~3
Maximum Cycle Rate	cycle/min	60
Operating Temperature	C°	-5~70

CHARACTERISTICS

- With a fixed, specially-designed orifice structure, an optimal impact absorption can be achieved even under variable operating conditions.
- The main unit can also be used as a stopper. (No external stopper required, except for FK-3625A)
- Three different types are available to accommodate various speeds. For low-speed: L, for medium-speed: M, for highspeed: H.
- Urethane cap specification is also available.
- Two or more of each product can be used in parallel.
- This product can also be custom-designed for optimal impact absorption.

PRECAUTIONS FOR USE

- Do not use this product without carefully reading the attached owner's manual.
- Do not turn the oil inlet screw located at the bottom of the main unit.
- Ensure that sufficient mounting strength is secured for this product. (As a guideline, it should be 2 to 3 times the maximum drag listed in the catalogue.)
- Urethane caps are consumable goods that need to be replaced with new ones if necessary.
- Do not use this product in a vacuum or a location where it may come in contact with oil.
- Ensure that an eccentric load is not applied to the soft absorber. (Allowable eccentric angle: $\pm 2.5^\circ$)
- Ensure that an external stopper (OP-020**) is also used. (The FK-0404 series can be used without a stopper.)

OPTIONAL PARTS

Eccentric angle adaptor OP-010EB

- When attaching the eccentric angle adaptor, screw it into the main unit until the cap for eccentric angle and the piston rod form a tight connection. While maintaining this position, fasten the main unit's nut until secured.
 - * If the eccentric angle adaptor is secured without establishing a tight fit, a sufficient stroke cannot be obtained. Furthermore, if the eccentric angle adaptor is further screwed in, after it has formed a tight connection, and then secured in place, the cap for eccentric angle cannot be pushed all the way to the stroke end.
- The inclined adapter is not available for models with soft absorber cap (-C) and urethane cap (-R)

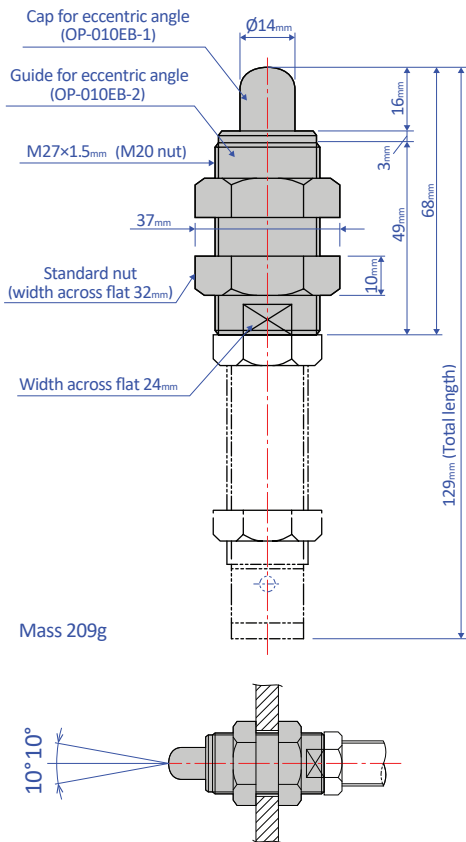

Urethane cap OP-090M20A

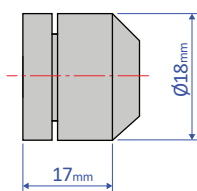

Stopper nut OP-020EB

- Adjust so that it stops 1 mm before the stroke end, and fasten with the main unit's nut until secured.

OP-020EB-S (without cap)

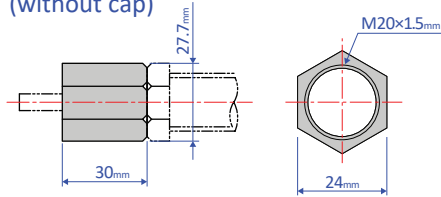

Mass 46g

OP-020EB-C (with cap)

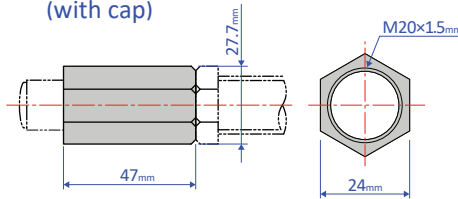

Mass 68g

Note: When attaching, make sure that the side without a bearing chamfer is the impact surface.

Standard nuts are sold separately as well - M20 Nut

Liquid-proof cap FK-2016M-C-060

- The main unit is supplied in assembly
- Ideal for use in environments where oil splatter poses a problem.
- Ensure that the cap is facing upward. If the cap is facing sideways or downward, it cannot provide an effective means for liquid proofing.

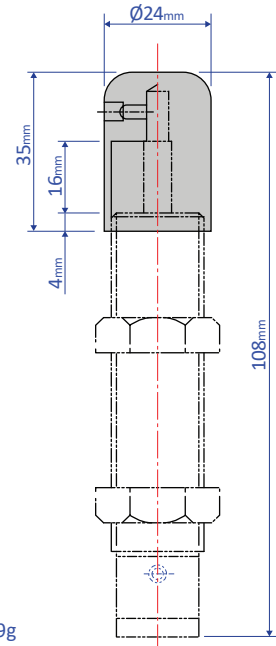

Mass 59g

Note: Liquid-proof caps are not sold separately

Flange OP-040EB

- This is a mounting fixture for soft absorbers

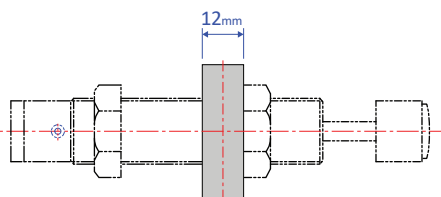
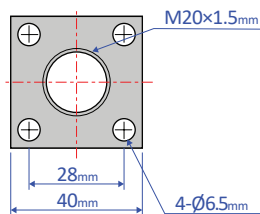

Mass 109g

Holder with a switch OP-032EB

- Position the holder in such a way that the tip of the switch and one of the ends of the metal ring for the rod cap are separated more than 0.5 mm. Cause of malfunction.

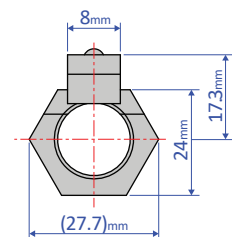
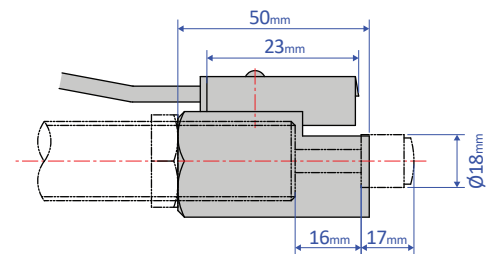

Mass 80g