

Click to  
**ORDER**  
samples

AM6GO-NZ

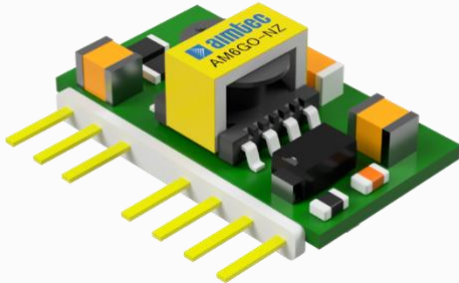

Open frame package

The AM6GO-NZ series is a high-performance open frame DC/DC converter specifically designed for a variety of telecom applications. It features 6W of output power with no requirement for minimum load, a wide input voltage of 36-75VDC, operating temperature up to 85°C and tested I/O isolation of 1500VDC.

Additionally, this series features include input under-voltage protection, output short-circuit, over-current protection, and remote On/Off control.

The AM6GO-NZ meets EN 62368 standards and are widely used in the industrial control, electric power instrumentation and communications.

Features

- High I/O Isolation 1500VDC
- Input under voltage protection, output over current and short circuit protection
- Operating Temp: -40 °C to +85 °C
- Compact open frame design and high-power density
- Efficiency up to 85%



Summary

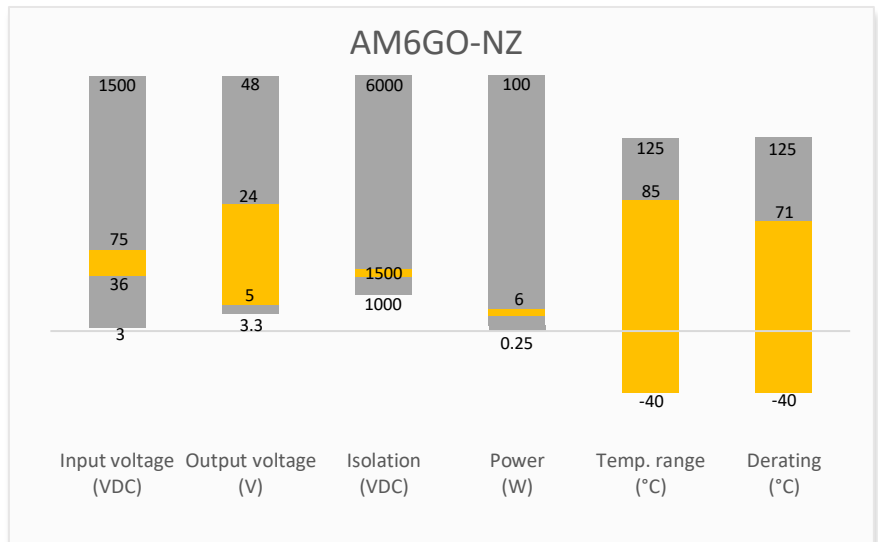

Training

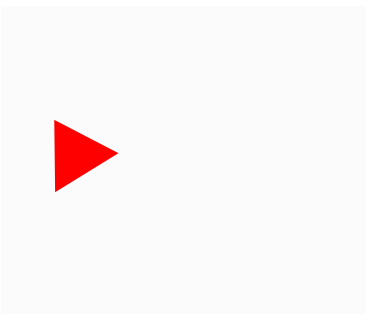

Product Training Video  
(click to open)

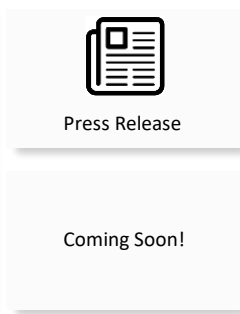

Application Notes

Applications



IoT



Industrial



Telecom



Portable Equipment

## Models & Specifications



### Single Output

Model	Input Voltage (VDC)	Output Voltage (VDC)	Maximum Output Current (A)	Maximum capacitive Load ( $\mu$ F)	Efficiency Typ. (%)
AM6GO-4805SNZ	48 (36-75)	5	1.2	1000	81
AM6GO-4812SNZ	48 (36-75)	12	0.5	470	83
AM6GO-4815SNZ	48 (36-75)	15	0.4	330	84
AM6GO-4824SNZ	48 (36-75)	24	0.25	100	85

### Input Specification

Parameters	Conditions	Typical	Maximum	Units
Input current	Nominal input voltage, full load /no load	155/3	159/12	mA
Filter	Capacitor filter			
Absolute maximum rating	Maximum duration 1s	>0.7	80	VDC
Input reflected ripple current		50		mA
Start-up voltage			36	VDC
UVLO		28		VDC
On/Off control	On	Control pin open or 3.5-12VDC		
	Off	Control pin short to -Vin or 0-1.2VDC		
	Idle current	3	10	mA

### Isolation Specification

Parameters	Conditions	Typical	Maximum	Units
Tested I/O voltage	60 sec, leakage $\leq$ 1mA	>1500		VDC
Resistance	500VDC	>1000		M $\Omega$
Capacitance	100kHz/0.1V	1000		pF

### Output Specification

Parameters	Conditions	Typical	Maximum	Units
Voltage accuracy	5-100% load	$\pm$ 1	$\pm$ 3	%
	0-5% load		$\pm$ 4	%
Line regulation	LL-HL	$\pm$ 0.5	$\pm$ 1	%
Load regulation	5-100% load	$\pm$ 0.5	$\pm$ 1.5	%
Temperature coefficient			$\pm$ 0.03	%/ $^{\circ}$ C
Ripple & Noise*	Nominal input voltage, 5-100% load	100	200	mV pk-pk
Transient Recovery Time	25% load step change	300	500	$\mu$ s
Transient Response Deviation	25% load step change, 5V output	$\pm$ 5	$\pm$ 8	%
	25% load step change, others	$\pm$ 2.5	$\pm$ 5	%

\* Ripple and Noise are measured at 20MHz bandwidth. Please refer to the application note for specific details.

### General Specifications

Parameters	Conditions	Typical	Maximum	Units
Switching frequency*		460		KHz
Short circuit protection	Continuous, auto recovery			

Over current protection		≥ 160	250	% of I <sub>o</sub>
Operating temperature	With derating	-40 to +85		°C
Storage temperature		-55 to +125		°C
Soldering temperature	Wave soldering, maximum duration 10s		260	°C
Cooling	Free air convection or forced air convection			
Humidity	Non-condensing	>5	95	% RH
Weight		2.2		g
Dimensions (L x W x H)		0.87 x 0.32 x 0.50 inches (22.00 x 8.20 x 12.80 mm)		
MTBF	1 000 000 hrs (MIL-HDBK -217F, t=+25°C) / Full Load			

\* Switching frequency reduced when load < 50%.

NOTE: All specifications in this datasheet are measured at an ambient temperature of 25°C, humidity<75%, nominal input voltage and at rated output load unless otherwise specified.

Environment Approval	
Parameters	Conditions
Vibration	10-150Hz, 5G, 0.75mm, along all axis

Safety Specifications		
Parameters		
Standards	Information technology Equipment	Design to meet EN 62368
	EMC - Conducted and radiated emission	CISPR32 / EN55032, class B with the recommended EMC circuit part B
	Electrostatic Discharge Immunity	IEC 61000-4-2 Contact ±4KV, Criteria B
	RF, Electromagnetic Field Immunity	EN 61000-4-3, 10V/m, Criteria A
	Electrical Fast Transient/Burst Immunity	EN 61000-4-4, ±2KV, Criteria B with the recommended EMC circuit part A
	Surge Immunity	EN 61000-4-5, ±2KV, Criteria B with the recommended EMC circuit part A
	RF, Conducted Disturbance Immunity	EN 61000-4-6, 3Vr.m.s, Criteria A

## Derating

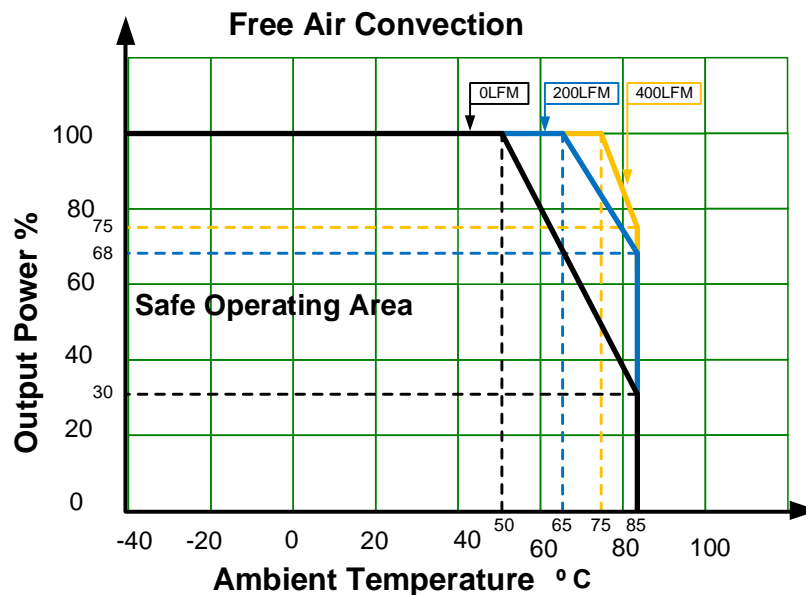

Typical application circuit

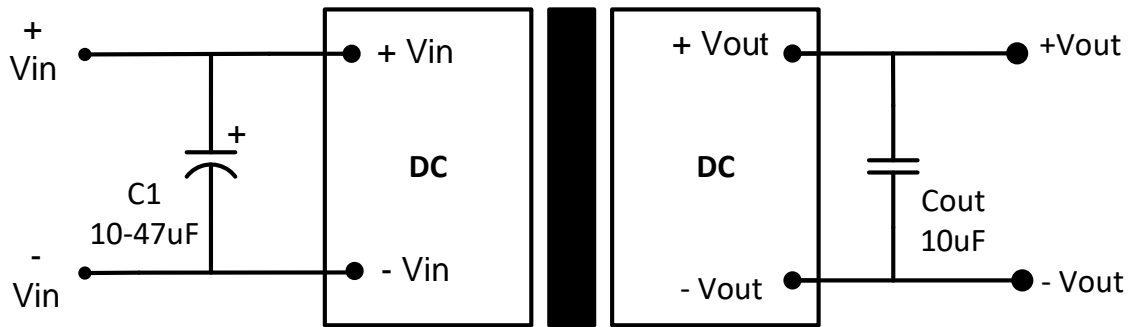

Recommended EMC circuit

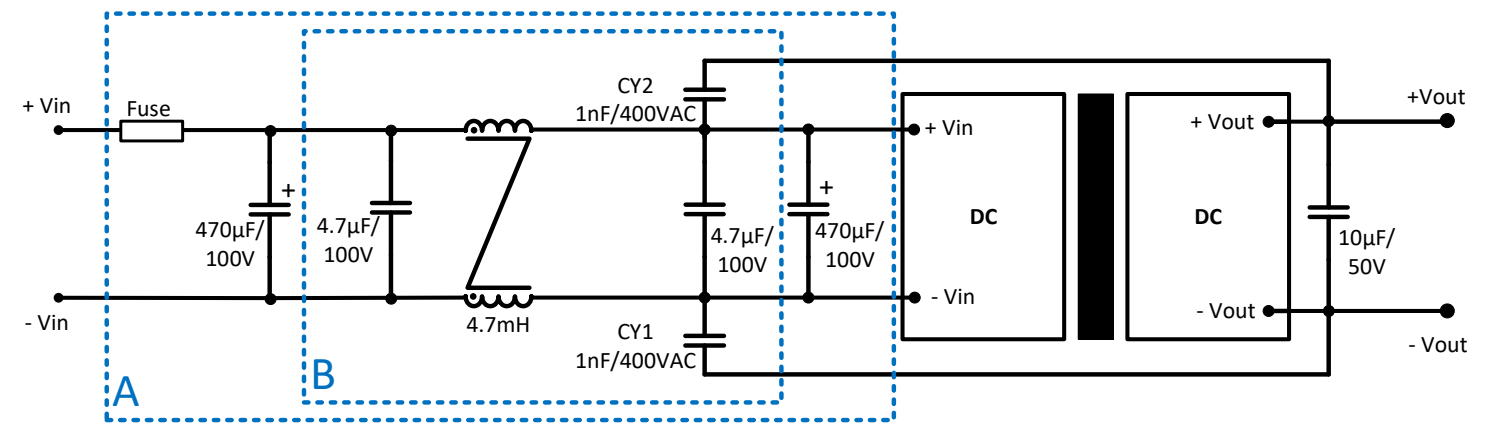

Note: Part A for EMC test, Part B for EMI test

Dimensions

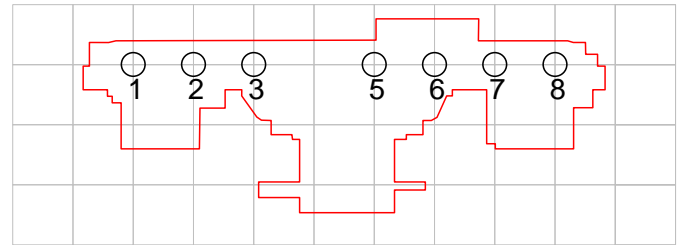
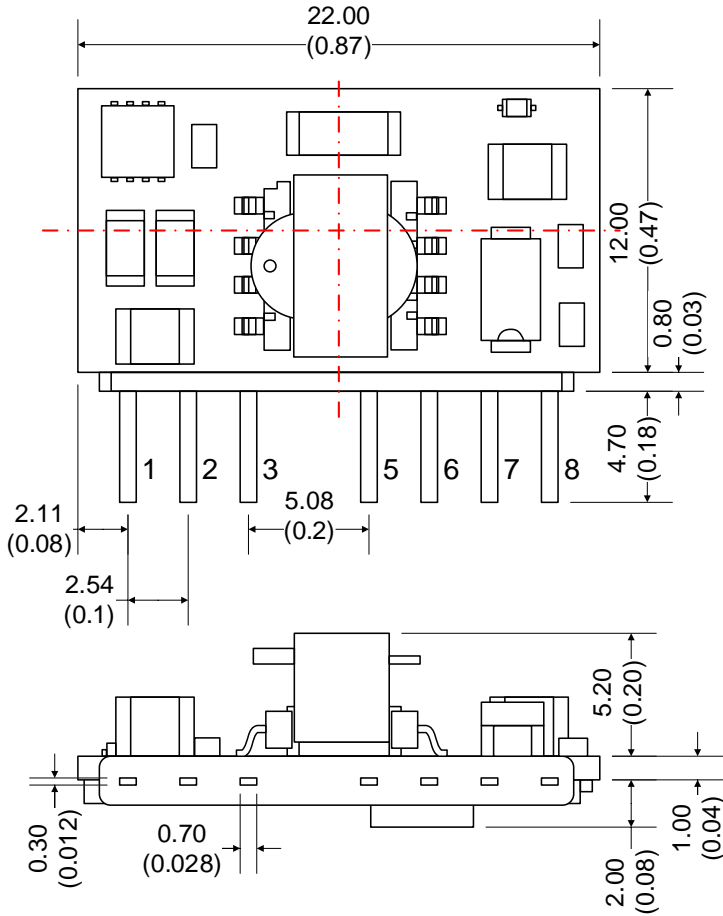

Grid size: 2.54 x 2.54mm

Note:  
Unit: mm(inch)  
General tolerance:  $\pm 0.5$  (0.02)

Pin Out Specifications	
Pin	Single
1	-Vin
2	+Vin
3	On/Off Control
5	NC
6	+Vout
7	-Vout
8	NC

**NOTE:** 1. Datasheets are updated as needed and as such, specifications are subject to change without notice. Once printed or downloaded, datasheets are no longer controlled by Aimtec; refer to [www.aimtec.com](http://www.aimtec.com) for the most current product specifications. 2. Product labels shown, including safety agency certifications on labels, may vary based on the date manufactured. 3. Mechanical drawings and specifications are for reference only. 4. All specifications are measured at an ambient temperature of 25°C, humidity<75%, nominal input voltage and at rated output load unless otherwise specified. 5. Aimtec may not have conducted destructive testing or chemical analysis on all internal components and chemicals at the time of publishing this document. CAS numbers and other limited information are considered proprietary and may not be available for release. 6. This product is not designed for use in critical life support systems, equipment used in hazardous environments, nuclear control systems or other such applications which necessitate specific safety and regulatory standards other the ones listed in this datasheet. 7. Warranty is in accordance with Aimtec's standard Terms of Sale available at [www.aimtec.com](http://www.aimtec.com).