

LTC7818

Triple Output Synchronous Step-Up/Dual Step-Down Supply

DESCRIPTION

Demonstration circuit DC2855A is a triple output synchronous step-up/dual step-down supply featuring the [LTC[®]7818](#). The demonstration circuit is designed for two buck outputs 5V/10A, 3.3V/10A supplied by a boosted 10V output. Benefiting from this feature, the buck outputs are able to maintain regulation over a wide input voltage range of 4.5V to 36V which is suitable for automotive or other battery fed applications. Also, the demonstration circuit uses a drop-in layout whereas the main buck circuit components fit in an area of ¾” by 1½”, while the main boost circuit area is ¾” by 1¾”. The package style for the LTC7818 is a 40-pin exposed pad QFN.

The main features of the board include rail tracking (Buck channels only), an internal 5V linear regulator for bias, separated RUN pins for each output, a PGOOD signal (CH1 only), an overvoltage indicator for CH3 and a Mode selector that allow the converter to run in CCM, Pulse-skipping or Burst Mode operation. Spread Spectrum Mode is available for EMI improvement. Synchronization to an external clock is also possible. The LTC7818 datasheet gives a complete description of these parts, operation and application information. The datasheet must be read in conjunction with this quick start guide for demo circuit 2855A.

[Design files for this circuit board are available.](#)

All registered trademarks and trademarks are the property of their respective owners.

PERFORMANCE SUMMARY Specifications are at T_A = 25°C

SYMBOL	PARAMETER	CONDITIONS	MIN	TYP	MAX	UNITS
V _{IN}	Input Supply Range	Operating (Note 1)	4.5		36	V
		Continuous operation, I _{OUT1} = 0A-10A, I _{OUT2} = 0A-10A, free air	8		16	V
V _{OUT1}	Output1 Voltage		3.2	3.3	3.4	V
V _{OUT2}	Output2 Voltage		4.9	5	5.1	V
V _{OUT3}	Output3 Voltage	V _{IN} = 4.5V-10V (Note 2)	9.8	10	10.2	V
I _{OUT1}	Output1 Current		0		10	A
I _{OUT2}	Output2 Current		0		10	A
I _{OUT3}	Output3 Current		0		10 (Note 3)	A
f _{SW}	Switching Frequency			2200		kHz
POUT/PIN	Efficiency	V _{IN} = 12V, V _{OUT1} = 3.3V, I _{OUT1} = 10A, RUN2 = 0		88		%
		V _{IN} = 12V, V _{OUT2} = 5V, I _{OUT2} = 10A, RUN1 = 0		91.6		%
		V _{IN} = 12V, V _{OUT1} = 5V, V _{OUT2} = 3.3V, I _{OUT1} = 10A, I _{OUT2} = 10A		90		%
		V _{IN} = 8V, V _{OUT3} = 10V, I _{OUT3} = 10A, RUN1, 2 = 0		94.6		%

Note 1: When 4.5V < V_{IN} < 8V and 16V < V_{IN} < 36V, only short time operation is allowed at maximum output power (free air). For example, run 10sec when V_{IN} = 4.5V, 2min when V_{IN} = 6V, 2min when V_{IN} = 26V, 10s when V_{IN} = 36V or continuously operate for de-rated output current.

Note 2: V_{OUT3} follows V_{IN} when V_{IN} > V_{OUT3}.

Note 3: 10A Maximum output includes the current supplying CH1 and CH2.

QUICK START PROCEDURE

Demonstration circuit DC2855A is easy to set up to evaluate the performance of the LTC7818. Refer to Figure 1 for the proper measurement equipment setup and follow the procedure below:

NOTE: When measuring the output voltage ripple, care must be taken to avoid a long ground lead on the oscilloscope probe. Measure the input or output voltage ripple by touching the probe tip directly across the V_{IN} or V_{OUT} and GND terminals or directly across the relevant capacitor. See Figure 2 for proper scope probe technique.

1. Place jumpers in the following positions:

JP1	ON
JP2	ON
JP3	ON
JP4	SPREAD OFF
JP5	Force Continuous Mode (FCM)

2. With power off, connect the input power supply to V_{IN} and GND. With power off, connect loads from V_{OUT} to GND.

3. Turn on the power at the input.

NOTE: Make sure that the input voltage does not exceed 36V.

4. Check for the proper output voltages.

$$V_{OUT1} = 3.2V \text{ to } 3.4V$$

$$V_{OUT2} = 4.9V \text{ to } 5.1V$$

$$V_{OUT3} = 9.8V \text{ to } 10.2V \text{ (} V_{OUT3} \text{ follows } V_{IN} \text{ when } V_{IN} \text{ is higher than } 10V \text{)}$$

NOTE: If there is no output, temporarily disconnect the load to make sure that the load is not set too high.

5. Once the proper output voltages are established, adjust the loads within the operating ranges and observe the output voltage regulation, ripple voltage, efficiency, and other parameters.

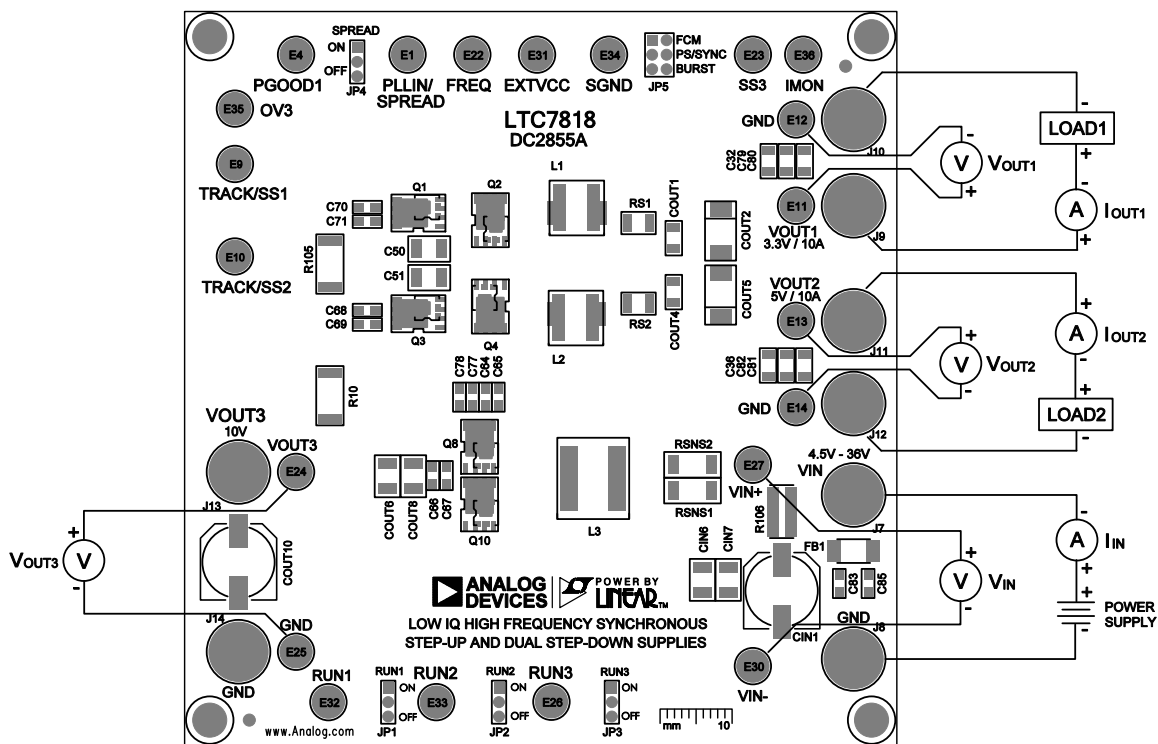

Figure 1. Proper Measurement Equipment Setup

QUICK START PROCEDURE

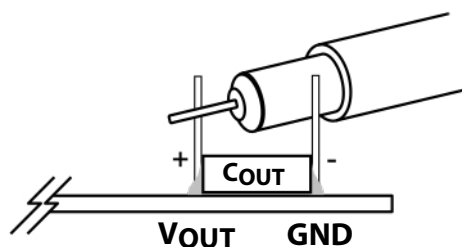

Figure 2. Proper Measurement Equipment Setup

Mode Selection, Spread Spectrum, and Frequency Synchronization

The Demonstration circuit 2855A’s Mode selector allows the converter to run in FCM operation, pulse skip operation, and Burst Mode by changing the position of JP5.

Spread Spectrum is enabled by placing JP4 to “ON” position. For synchronizing to an external clock source, JP4 jumper needs to be removed. Apply the external clock from PLLIN/SPREAD turret to GND. Refer to Table 1 and to the datasheet for more details.

Rail Tracking

Demonstration circuit 2855A is configured for an on-board soft-start circuit. The soft-start ramp rate can be adjusted by changing the value of C2 and C47. Demonstration circuit 2855A can also be modified to track an external reference. Refer to Table 2 and Table 3 for tracking options and to the datasheet for more details.

Table 1. Mode Selection and Synchronizing Operation Options

CONFIGURATION	MODE JUMPER
Forced CCM Mode Operation	“FCM”
Pulse Skip Mode Operation	“PS”
Burst Mode Operation	“BURST”
Synchronize to Ext. clock (Ext. clock apply to PLLIN/SPREAD turret)	Remove Jumper JP4
Spread Spectrum Mode	“SPREAD ON”

Table 2. V_{OUT1} Tracking Options

CONFIGURATION	R2	R3	C2	TRK/SS1 CAP
Soft Start Without Tracking (Default)	OPEN	OPEN	0.1uF	OPEN
V_{OUT1} Tracking Scaled V_{OUT2}	Resistor Divider		OPEN	OPEN

Table 3. V_{OUT2} Tracking Options

CONFIGURATION	R34	R37	C47	TRK/SS2 CAP
Soft Start Without Tracking (Default)	0Ω	OPEN	0.1uF	OPEN
V_{OUT2} Equals External Ramp	0Ω	OPEN	OPEN	External Ramp
V_{OUT2} Tracking Scaled External Ramp	Resistor Divider		OPEN	External Ramp

QUICK START PROCEDURE

Optional Inductor DCR Current Sensing

Demonstration circuit 2855A provides an optional circuit for Inductor DCR Current Sensing. Inductor DCR Current Sensing uses the DC resistance of the inductor to sense the inductor current instead of discrete sense resistors. The advantages of DCR sensing are lower cost, reduced board space, and higher efficiency, but the disadvantage is a less accurate current limit. If DCR sensing is used, be sure to select an inductor with a sufficiently high saturation current.

Refer to Table 4 for Optional Inductor DCR Current Sensing setup and to the datasheet for more details.

Low Quiescent Current Applications

The typical quiescent current (I_Q) of the LTC7818 controller is 14uA in sleep mode as specified in the LTC7818 datasheet. However, the input current of the DC2855A board can be higher than this value because of the additional circuit outside of the IC. Several methods can be adopted to reduce the total input current: (1) Large value FB divider resistors should be used; (2) If 8V or 10V boost output is required, connecting V_{PRG3} to GND or $INTV_{CC}$, with V_{FB3} directly connected to the output can reduce I_Q ; (3) In addition, the optional pull-up resistors should be removed from the board.

Minimum On-Time Causes Channel 2 And Channel 3 To Skip Pulses

The typical minimum on-time $T_{on(min)}$ of the LTC7818 is 40ns for the Buck channels, and 80ns for the boost channel as specified in the datasheet. Therefore, when the input voltage is higher than 30V the CH2 may start to skip pulses at no load condition. And when the input voltage is higher than 7.5V, the CH3 may start to skip pulses at no load condition.

Thermal Derating Of The Buck Channels

The maximum DC output current of each Buck channel is specified at the nominal input voltage, which is 8V~16V. At higher input voltage, because of the increased power losses, the output currents should be derated. The power devices (Power MOSFETs, inductors) surface temperature must be monitored to ensure safe steady-state operation at higher input voltages.

EXTV_{CC} Supply

With the high switching frequency, the power losses imposed on the LTC7818 on-board gate drivers and LDO become a concern. Apply an external supply voltage to the EXTV_{CC} turret can help reduce LDO loss. On the DC2855A board, by removing R55 and placing zero ohm for R93, 5V (output of channel 2) will be provided for EXTV_{CC}.

Table 4. Optional Inductor DCR Current Sensing

CONFIGURATION	CHANNEL1	RS1	R29	R30	C14	R45	R47	R61
	CHANNEL2	RS2	R39	R40	C15	R51	R53	R62
	CHANNEL3	RSNS1,2	R80	R81	C56	R89	R90	R91
Current Sense Resistor (Default)		Ref. Sch.	Ref. Sch.	Ref. Sch.	Ref. Sch.	OPEN	OPEN	OPEN
Inductor DCR Current Sensing		0Ω Copper	OPEN	OPEN	Calculated Value from Datasheet			0Ω

TYPICAL PERFORMANCE CHARACTERISTICS

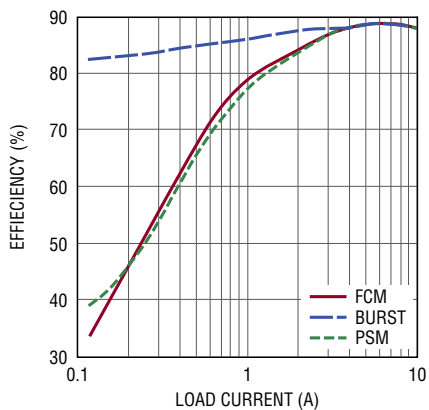

Figure 3. CH1 Efficiency ($V_{IN} = 12V$, $V_{OUT1} = 3.3V$)

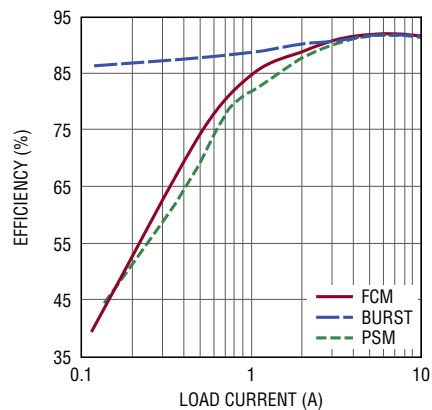

Figure 4. CH2 Efficiency ($V_{IN} = 12V$, $V_{OUT2} = 5V$)

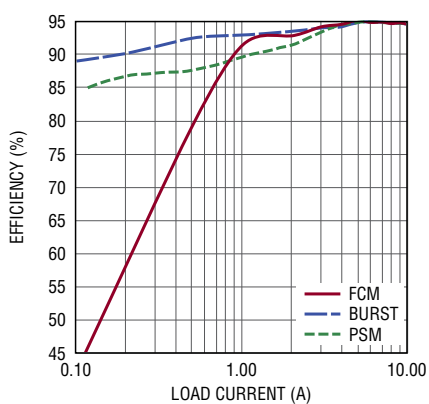

Figure 5. CH3 Efficiency ($V_{IN} = 8V$, $V_{OUT3} = 10V$)

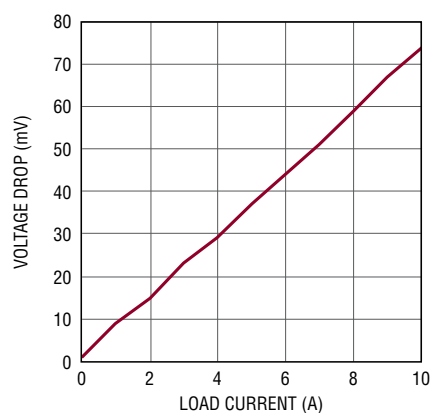

Figure 6. CH3 Voltage Drop in Pass-through Mode

TYPICAL PERFORMANCE CHARACTERISTICS

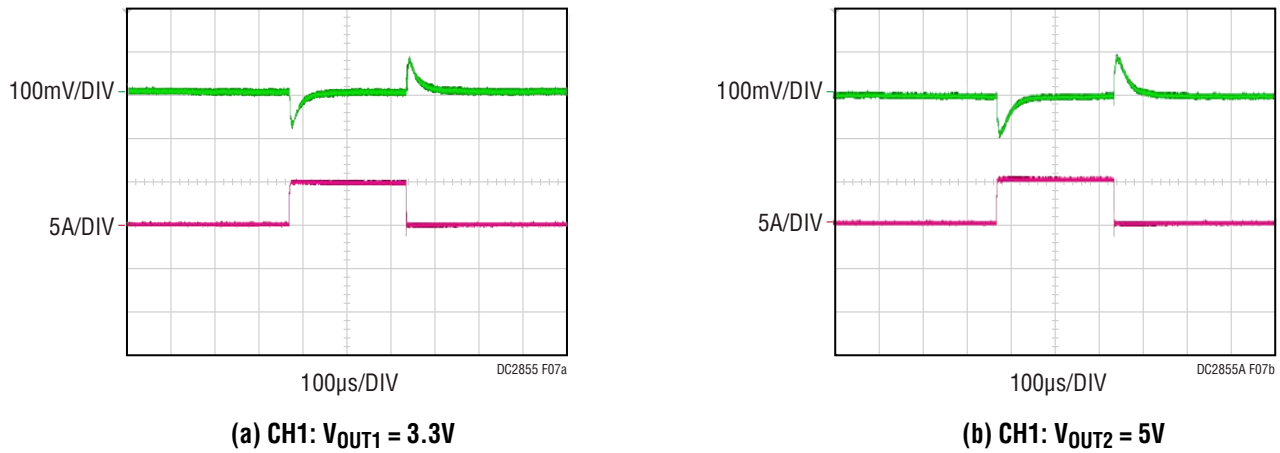

Figure 7. Transient Response Waveform at 12V V_{IN} and 5A – 10A – 5A load current

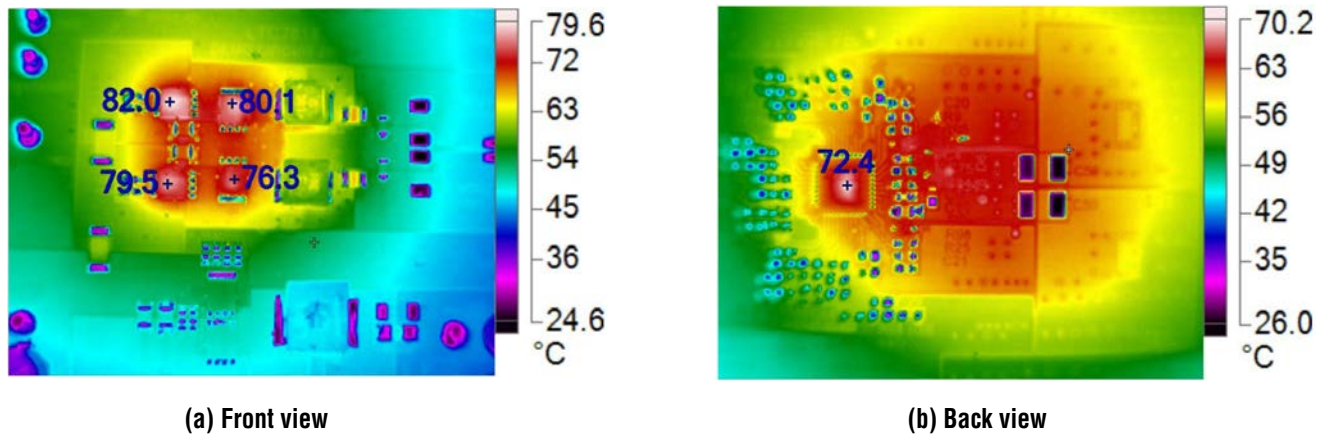

Figure 8. Thermal Image: $V_{IN} = 12V$, $V_{OUT1} = 3.3V$, $I_{OUT1} = 10A$, $V_{OUT2} = 5V$, $I_{OUT2} = 10A$, NO AIR FLOW, $T_A = 25^\circ C$

TYPICAL PERFORMANCE CHARACTERISTICS

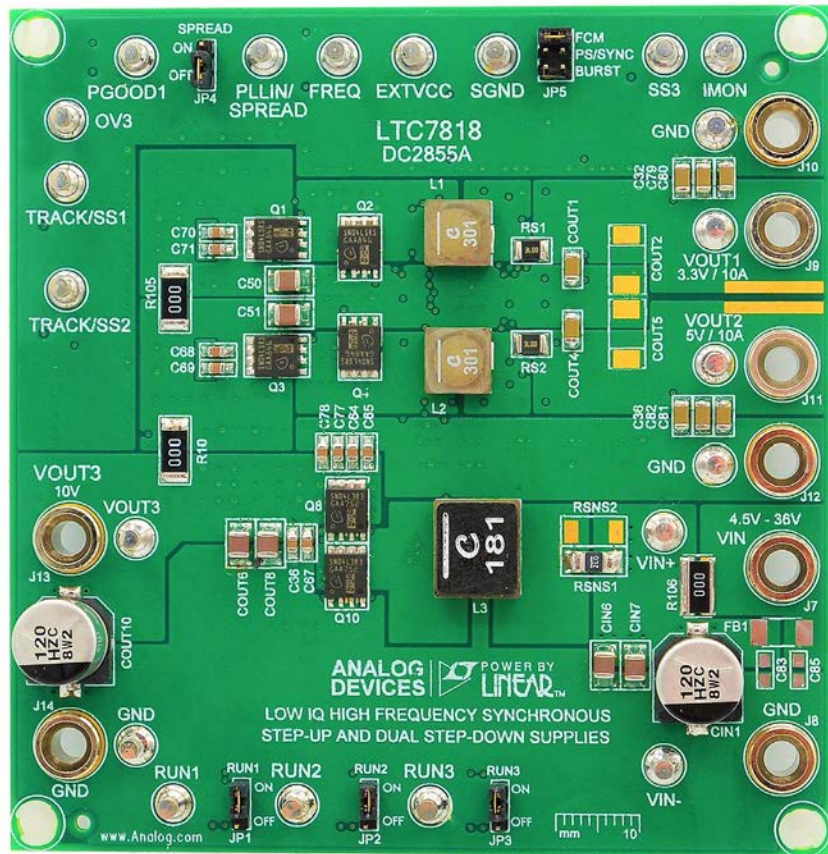

Figure 9. Picture of demo board

DEMO MANUAL DC2855A

PARTS LIST

ITEM	QTY	REFERENCE	PART DESCRIPTION	MANUFACTURER/PART, NUMBER
Required Circuit Components				
1	6	C2, C17, C20, C21, C47, C52	CAP, 0.1uF, X7R, 25V, 10%, 0603	AVX, 06033C104KAT2A
2	1	C4	CAP, 1uF, X7R, 16V, 10%, 0603	KEMET, C0603C105K4RAC7867
3	1	C11	CAP, 4.7uF, X5R, 6.3V, 10%, 0805	AVX, 08056D475KAT2A
4	5	C14, C15, C56, C62, C74	CAP, 1000pF, X7R, 50V, 10%, 0603	AVX, 06035C102KAT2A
5	8	C32, C36, C79, C80, C81, C82, COUT1, COUT4	CAP, 47uF, X5R, 6.3V, 20%, 1206	MURATA, GRM31CR60J476ME19L
6	2	C37, C49	CAP, 10pF, X7R, 50V, 10%, 0603	AVX, 06035C100KAT2A
7	1	C41	CAP, 2200pF, X7R, 25V, 10%, 0603	AVX, 06033C222KAT2A
8	2	C42, C43	CAP, 47pF, COG, 50V, 5%, 0603, AEC-Q200	AVX, 06035A470J4T2A
9	1	C44	CAP, 2200pF, X7R, 50V, 10%, 0603	AVX, 06035C222KAT2A
10	9	C50, C51, CIN6, CIN7, COUT6, COUT7, COUT8, CIN8, CIN9	CAP, 10uF, X7S, 50V, 10%, 1210	TAIYO YUDEN, UMK325C7106KM-T
11	1	C53	CAP, 820pF, COG, 50V, 5%, 0603	AVX, 06035A821JAT2A
12	1	C54	CAP, 0.01uF, X7R, 50V, 10%, 0603	AVX, 06035C103KAT2A
13	10	C64, C65, C66, C67, C68, C69, C70, C71, C77, C78	CAP, 1uF, X7R, 50V, 10%, 0805	TAIYO, YUDEN, UMK212B7105KG-T
14	2	CIN1, COUT10	CAP, 120uF, ALUM. ELECT., 50V, 20%, 10x10.2mm SMD, RADIAL, AEC-Q200	PANASONIC, EEHZC1H121P
15	2	D1, D2	DIODE, SCHOTTKY, 40V, 250mW, SOD-323	CENTRAL SEMI., CMDSH-4E, TR, Lead, Free
16	1	D6	DIODE, SCHOTTKY, 100V, 250mW, SOD-323	ROHM, RB578VYM100FH
17	2	L1, L2	IND., 0.3uH, PWR., 20%, 10A, 21.45mOHMS, SMD 7.5mmX7.5mm, AEC-Q200	COILCRAFT, XAL7030-301ME
18	1	L3	IND., 0.18uH, PWR., 20%, 120A, 11.3x10mm SMD, XAL1060, AEC-Q200	COILCRAFT, XAL1060-181MEC
19	4	Q1, Q2, Q3, Q4	XSTR., MOSET, N-CH, 40V, 50A, PG-TDSON-8-33, AEC-Q101	INFINEON, IPC50N04S5L-5R5
20	2	Q8, Q10	XSTR., MOSFET, N-CH, 40V, 90A, PG-TDSON-8-33, AEC-Q101	INFINEON, IPC90N04S5L-3R3
21	18	R9, R25, R29, R34, R36, R39, R55, R70, R78, R80, R84, R87, R94, R95, R96, R97, R98, R99	RES., 0 OHM, 1/10W, 0603, AEC-Q200	VISHAY, CRCW06030000Z0EA
22	2	R10, R105	RES., 0 OHM, 1W, 2512, 7A, AEC-Q200	VISHAY, CRCW25120000Z0EG
23	2	R30, R40	RES., 20 OHM, 1/10W, 0603, AEC-Q200	PANASONIC, ERJ-3EKF20R0V
24	5	R26, R38, R46, R48, R104	RES., 100k OHMS, 5%, 1/10W, 0603	PANASONIC, ERJ3GEYJ104V
25	2	R106, R107	RES., 0 OHMS, 2W, 2512 LONG SIDE TERM, AEC-Q200	VISHAY, RCL12250000Z0EG
26	1	R27	RES., 210k OHMS, 1%, 1/10W, 0603	NIC, NRC06F2103TRF
27	1	R31	RES., 10k OHMS, 1%, 1/10W, 0603, AEC-Q200	PANASONIC, ERJ3EKF1002V
28	2	R32, R33	RES., 68.1k OHMS, 1%, 1/10W, 0603, AEC-Q200	PANASONIC, ERJ3EKF6812V
29	1	R35	RES., 9.1k OHMS, 1%, 1/10W, 0603, AEC-Q200	PANASONIC, ERJ3EKF9101V

PARTS LIST

ITEM	QTY	REFERENCE	PART DESCRIPTION	MANUFACTURER/PART, NUMBER
30	1	R43	RES., 357k OHMS, 1%, 1/10W, 0603, AEC-Q200	PANASONIC, ERJ3EKF3573V
31	1	R75	RES., 3.6k OHMS, 1%, 1/10W, 0603, AEC-Q200	PANASONIC, ERJ3EKF3601V
32	1	R81	RES., 249 OHMS, 1%, 1/10W, 0603, AEC-Q200	PANASONIC, ERJ3EKF2490V
33	1	R86	RES., 2.2 OHMS, 5%, 1/10W, 0603, AEC-Q200	PANASONIC, ERJ3GEYJ2R2V
34	1	R92	RES., 1M OHM, 1%, 1/10W, 0603, AEC-Q200	VISHAY, CRCW06031M00FKEA
35	2	RS1, RS2	RES., 0.003 OHMS, 5%, 1W, 1210, AEC-Q200	ROHM, PMR25HZPJV3L0
36	1	RSNS1	RES., 0.002 OHMS, SENSE, 1%, 2W, 2010, AEC-Q200, PULSE PROOF	VISHAY, WSLP20102L000FEA
37	1	U1	IC, HIGH FREQ. SYNCHRONOUS STEP UP/DUAL STEP-DOWN POWER SUPPLY, 40QFN	ANALOG DEVICES, LTC7818EUJ#PBF

Additional Demo Board Circuit Components

1	0	C38, C48, C55, C57, C60, C75, C76	CAP, OPTION, 0603	
2	0	C58, C59	CAP, OPTION, 1210	
3	0	C61, C72, C73, C83, C84, C85, C86	CAP, OPTION, 0805	
4	0	COUT2, COUT5	CAP, OPTION, 7343	
5	0	FB1, FB2	IND., OPTION, 1812	
6	0	Q9, Q11	XSTR., OPTION, MOSFET N-CH, PG-TDSON-8	
7	0	Q12, Q13, Q14, Q15, Q16, Q17, Q18, Q19	XSTR., OPTION, MOSFET N-CH, PPAK SO-8	
8	0	R2, R3, R28, R37, R41, R45, R47, R51, R53, R61, R62, R72, R76, R77, R79, R85, R89, R90, R91, R93, R100, R103	RES., OPTION, 0603	
9	0	R82	RES., OPTION, 1206	
10	0	RSNS2	RES., OPTION, 2010	

Hardware: For Demo Board Only

1	21	E1, E4, E9, E10, E11, E12, E13, E14, E22, E23, E24, E25, E26, E27, E30, E31, E32, E33, E34, E35, E36	TEST POINT, TURRET, 0.094" MTG. HOLE, PCB 0.062" THICK	MILL-MAX
2	8	J7, J8, J9, J10, J11, J12, J13, J14	CONN., BANANA JACK, FEMALE, THT, NON-INSULATED, SWAGE, 0.218"	KEystone
3	4	JP1, JP2, JP3, JP4	CONN., HDR, MALE, 1x3, 2mm, VERT, STR, THT, NO SUBS. ALLOWED	WURTH ELEKTRONIK
4	1	JP5	CONN., HDR, MALE, 2x3, 2mm, VERT, STR, THT	WURTH ELEKTRONIK
5	5	XJP1, XJP2, XJP3, XJP4, XJP5	CONN., SHUNT, FEMALE, 2 POS, 2mm	WURTH ELEKTRONIK
6	4	MP1, MP2, MP3, MP4	STANDOFF, NYLON, SNAP-ON, 0.50"	WURTH ELEKTRONIK

DEMO MANUAL DC2855A

SCHEMATIC DIAGRAM

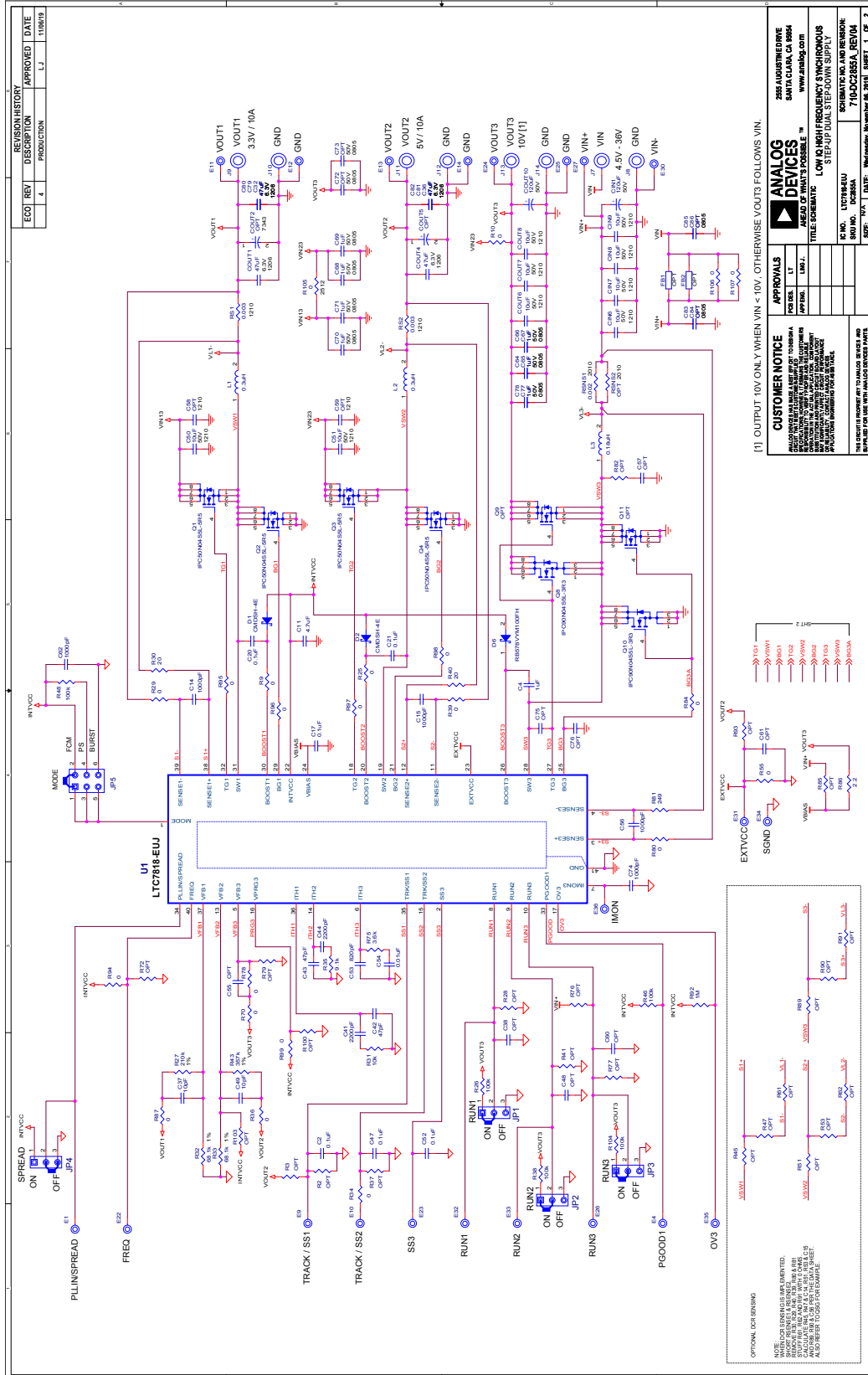

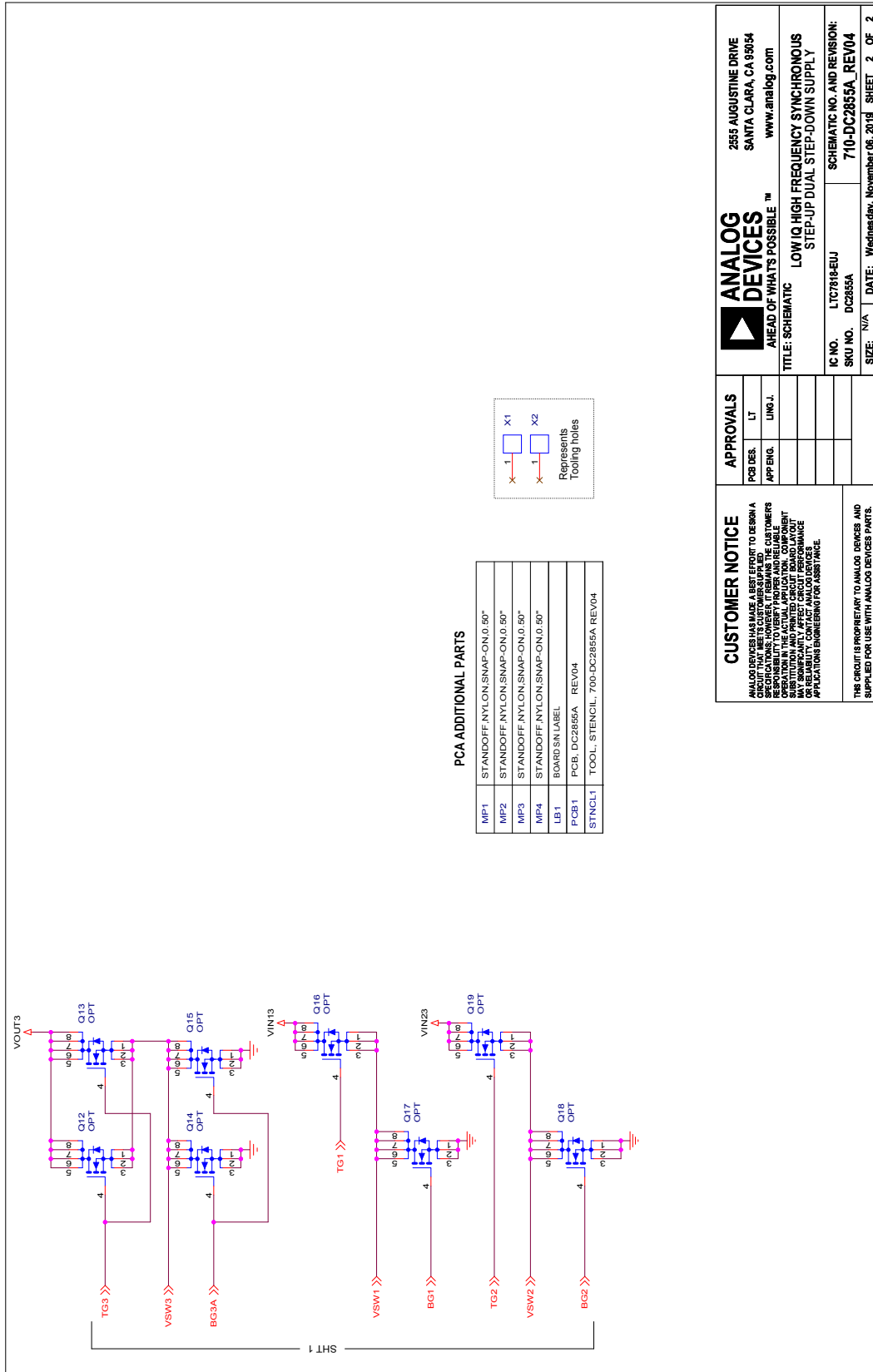

PCA ADDITIONAL PARTS

MP1	STANDOFF, NYLON, SNAP-ON, 0.50"
MP2	STANDOFF, NYLON, SNAP-ON, 0.50"
MP3	STANDOFF, NYLON, SNAP-ON, 0.50"
MP4	STANDOFF, NYLON, SNAP-ON, 0.50"
LB1	BOARD SN LABEL
PCB1	PCB, DC2855A, REV04
STNCL1	TOOL, STENCIL, 700-DC2855A, REV04

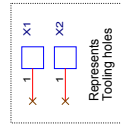

		255 AUGUSTINE DRIVE SANTA CLARA, CA 95054 www.analog.com	
		ANALOG DEVICES AHEAD OF WHAT'S POSSIBLE™	
TITLE: SCHEMATIC LOW IQ HIGH FREQUENCY SYNCHRONOUS STEP-UP DUAL STEP-DOWN SUPPLY		IC NO. LTC7816-EUJ	SCHEMATIC NO. AND REVISION: 710-DC2855A_REV04
APPROVALS		SKU NO. DC2855A	DATE: Wednesday, November 06, 2019
PCB DES.	LT	SIZE: N/A	SHEET 2 OF 2
APP ENG.	LING J.		
CUSTOMER NOTICE ANALOG DEVICES HAS MADE A BEST EFFORT TO DESIGN A CIRCUIT THAT MEETS CUSTOMER SUPPLIED REQUIREMENTS. HOWEVER, WE CANNOT GUARANTEE THE OPERATION OF THE CIRCUIT IN THE ACTUAL APPLICATION. COMPONENT PARTS ARE NOT TESTED FOR RELIABILITY. PERFORMANCE MAY SIGNIFICANTLY AFFECT CIRCUIT PERFORMANCE. APPLICATION ENGINEERING FOR ADDITIONAL INFORMATION.		THIS CIRCUIT IS PROPRIETARY TO ANALOG DEVICES AND SUPPLIED FOR USE WITH ANALOG DEVICES PARTS.	



ESD Caution

ESD (electrostatic discharge) sensitive device. Charged devices and circuit boards can discharge without detection. Although this product features patented or proprietary protection circuitry, damage may occur on devices subjected to high energy ESD. Therefore, proper ESD precautions should be taken to avoid performance degradation or loss of functionality.

Legal Terms and Conditions

By using the evaluation board discussed herein (together with any tools, components documentation or support materials, the "Evaluation Board"), you are agreeing to be bound by the terms and conditions set forth below ("Agreement") unless you have purchased the Evaluation Board, in which case the Analog Devices Standard Terms and Conditions of Sale shall govern. Do not use the Evaluation Board until you have read and agreed to the Agreement. Your use of the Evaluation Board shall signify your acceptance of the Agreement. This Agreement is made by and between you ("Customer") and Analog Devices, Inc. ("ADI"), with its principal place of business at One Technology Way, Norwood, MA 02062, USA. Subject to the terms and conditions of the Agreement, ADI hereby grants to Customer a free, limited, personal, temporary, non-exclusive, non-sublicensable, non-transferable license to use the Evaluation Board FOR EVALUATION PURPOSES ONLY. Customer understands and agrees that the Evaluation Board is provided for the sole and exclusive purpose referenced above, and agrees not to use the Evaluation Board for any other purpose. Furthermore, the license granted is expressly made subject to the following additional limitations: Customer shall not (i) rent, lease, display, sell, transfer, assign, sublicense, or distribute the Evaluation Board; and (ii) permit any Third Party to access the Evaluation Board. As used herein, the term "Third Party" includes any entity other than ADI, Customer, their employees, affiliates and in-house consultants. The Evaluation Board is NOT sold to Customer; all rights not expressly granted herein, including ownership of the Evaluation Board, are reserved by ADI. CONFIDENTIALITY. This Agreement and the Evaluation Board shall all be considered the confidential and proprietary information of ADI. Customer may not disclose or transfer any portion of the Evaluation Board to any other party for any reason. Upon discontinuation of use of the Evaluation Board or termination of this Agreement, Customer agrees to promptly return the Evaluation Board to ADI. ADDITIONAL RESTRICTIONS. Customer may not disassemble, decompile or reverse engineer chips on the Evaluation Board. Customer shall inform ADI of any occurred damages or any modifications or alterations it makes to the Evaluation Board, including but not limited to soldering or any other activity that affects the material content of the Evaluation Board. Modifications to the Evaluation Board must comply with applicable law, including but not limited to the RoHS Directive. TERMINATION. ADI may terminate this Agreement at any time upon giving written notice to Customer. Customer agrees to return to ADI the Evaluation Board at that time. LIMITATION OF LIABILITY. THE EVALUATION BOARD PROVIDED HEREUNDER IS PROVIDED "AS IS" AND ADI MAKES NO WARRANTIES OR REPRESENTATIONS OF ANY KIND WITH RESPECT TO IT. ADI SPECIFICALLY DISCLAIMS ANY REPRESENTATIONS, ENDORSEMENTS, GUARANTEES, OR WARRANTIES, EXPRESS OR IMPLIED, RELATED TO THE EVALUATION BOARD INCLUDING, BUT NOT LIMITED TO, THE IMPLIED WARRANTY OF MERCHANTABILITY, TITLE, FITNESS FOR A PARTICULAR PURPOSE OR NON-INFRINGEMENT OF INTELLECTUAL PROPERTY RIGHTS. IN NO EVENT WILL ADI AND ITS LICENSORS BE LIABLE FOR ANY INCIDENTAL, SPECIAL, INDIRECT, OR CONSEQUENTIAL DAMAGES RESULTING FROM CUSTOMER'S POSSESSION OR USE OF THE EVALUATION BOARD, INCLUDING BUT NOT LIMITED TO LOST PROFITS, DELAY COSTS, LABOR COSTS OR LOSS OF GOODWILL. ADI'S TOTAL LIABILITY FROM ANY AND ALL CAUSES SHALL BE LIMITED TO THE AMOUNT OF ONE HUNDRED US DOLLARS (\$100.00). EXPORT. Customer agrees that it will not directly or indirectly export the Evaluation Board to another country, and that it will comply with all applicable United States federal laws and regulations relating to exports. GOVERNING LAW. This Agreement shall be governed by and construed in accordance with the substantive laws of the Commonwealth of Massachusetts (excluding conflict of law rules). Any legal action regarding this Agreement will be heard in the state or federal courts having jurisdiction in Suffolk County, Massachusetts, and Customer hereby submits to the personal jurisdiction and venue of such courts. The United Nations Convention on Contracts for the International Sale of Goods shall not apply to this Agreement and is expressly disclaimed.