

**SINGLE-PHASE GLASS PASSIVATED  
SILICON BRIDGE RECTIFIER**  
VOLTAGE 1300 Volts CURRENT 1.0 Ampere

**FEATURES**

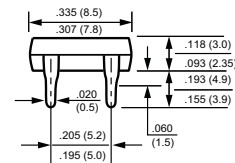
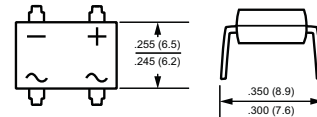
- \* Good for automation insertion
- \* Surge overload rating - 40 amperes peak
- \* Ideal for printed circuit board
- \* Reliable low cost construction utilizing molded
- \* Glass passivated device
- \* Polarity symbols molded on body
- \* Mounting position: Any
- \* Weight: 1.0 gram

**MECHANICAL DATA**

- \* Epoxy: Device has UL flammability classification 94V-O
- \* UL listed under the recognized component directory, file #E94233.



**DB-1**



Dimensions in inches and (millimeters)

**MAXIMUM RATINGS AND ELECTRICAL CHARACTERISTICS**

Ratings at 25 °C ambient temperature unless otherwise specified.  
Single phase, half wave, 60 Hz, resistive or inductive load.  
For capacitive load, derate current by 20%.

**MAXIMUM RATINGS** (At  $T_A = 25^\circ\text{C}$  unless otherwise noted)

RATINGS	SYMBOL	DB1012	UNITS
Maximum Recurrent Peak Reverse Voltage	$V_{RRM}$	1300	Volts
Maximum RMS Bridge Input Voltage	$V_{RMS}$	910	Volts
Maximum DC Blocking Voltage	$V_{DC}$	1300	Volts
Maximum Average Forward Output Current at $T_A = 40^\circ\text{C}$	$I_O$	1.0	Amps
Peak Forward Surge Current 8.3 ms single half sine-wave superimposed on rated load (JEDEC method)	$I_{FSM}$	40	Amps
Typical Current Squared Time	$I^2T$	6.64	$\text{A}^2\text{S}$
Typical Thermal Resistance (Note 2)	$R_{\theta JA}$	40	$^\circ\text{C}/\text{W}$
	$R_{\theta JL}$	15	
Operating and Storage Temperature Range	$T_J, T_{STG}$	-55 to + 150	$^\circ\text{C}$

**ELECTRICAL CHARACTERISTICS** (At  $T_A = 25^\circ\text{C}$  unless otherwise noted)

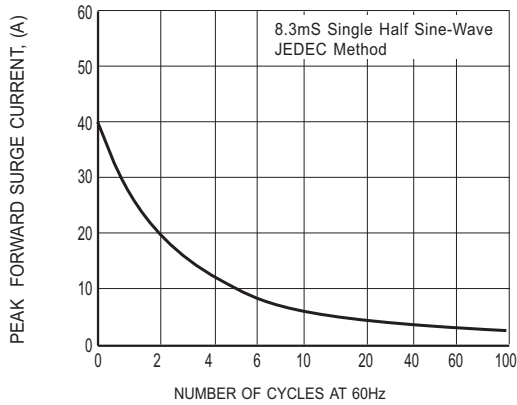
CHARACTERISTICS	SYMBOL	DB1012	UNITS
Maximum Forward Voltage Drop per Bridge Element at 1.0A DC	$V_F$	1.0	Volts
Maximum Reverse Current at Rated DC Blocking Voltage per element	@ $T_A = 25^\circ\text{C}$	1.0	$\mu\text{Amps}$
	@ $T_A = 125^\circ\text{C}$	0.05	$\text{mAmps}$

Note: 1."ROHS compliant"

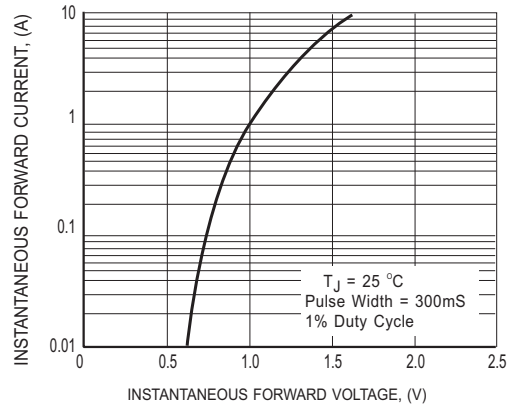
2. Thermal Resistance: PCB mounted.

2021-07  
REV:B

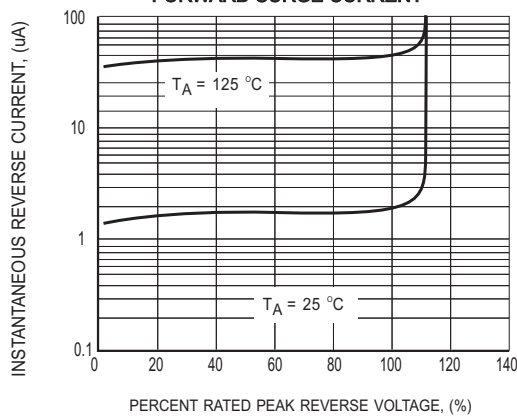
## RATING AND CHARACTERISTICS CURVES ( DB1012 )



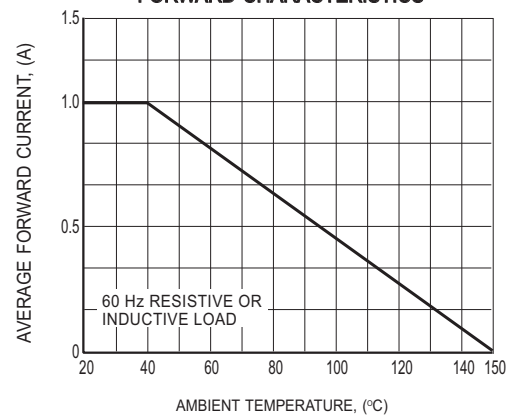
**FIG. 1 - MAXIMUM NON-REPETITIVE FORWARD SURGE CURRENT**



**FIG. 2 TYPICAL INSTANTANEOUS FORWARD CHARACTERISTICS**

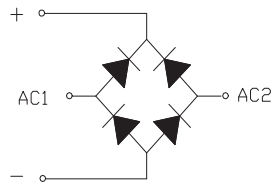


**FIG. 3 TYPICAL REVERSE CHARACTERISTICS**

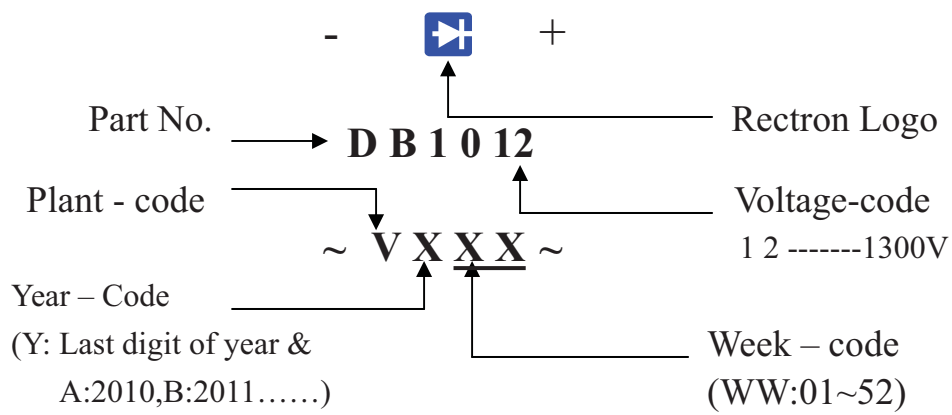


**FIG. 4 TYPICAL FORWARD CURRENT DERATING CURVE**

## 1. Internal Circuit



## 2. Marking on the body



## PACKAGING OF DIODE AND BRIDGE RECTIFIERS

### TUBE PACK

PACKAGE	PACKING CODE	EA PER BOX	INNER BOX SIZE (mm)	CARTON SIZE (mm)	EA PER CARTON	WEIGHT(Kg)
DB-1	-C	2,500	440*130*65	460*290*150	10,000	6.80

## DISCLAIMER NOTICE

Rectron Inc reserves the right to make changes without notice to any product specification herein, to make corrections, modifications, enhancements or other changes. Rectron Inc or anyone on its behalf assumes no responsibility or liability for any errors or inaccuracies. Data sheet specifications and its information contained are intended to provide a product description only. "Typical" parameters which may be included on RECTRON data sheets and/ or specifications can and do vary in different applications and actual performance may vary over time. Rectron Inc does not assume any liability arising out of the application or use of any product or circuit.

Rectron products are not designed, intended or authorized for use in medical, life-saving implant or other applications intended for life-sustaining or other related applications where a failure or malfunction of component or circuitry may directly or indirectly cause injury or threaten a life without expressed written approval of Rectron Inc. Customers using or selling Rectron components for use in such applications do so at their own risk and shall agree to fully indemnify Rectron Inc and its subsidiaries harmless against all claims, damages and expenditures.