

UWB: 3.3 – 7.2 GHz Chip Antenna



ACG0806U

Request Samples



Check Inventory



8.0 x 6.0 x 1.2mm
RoHS Compliant
MSL Level = 1

Features

- BW of 4000 MHz
- Linear Polarization
- VSWR <3.5
- Extended Operating Temperature of -40/+105 °C

Applications

- UWB (Ultra-Wide Band)
- IoT
- M2M
- Secure car access
- Item Tracking
- Indoor Navigation
- Hands-Free Payment
- Smart Access
- Object Detection

Product Image



UWB: 3.3 – 7.2 GHz Chip Antenna



ACG0806U

Request Samples



Check Inventory



8.0 x 6.0 x 1.2mm
RoHS Compliant
MSL Level = 1

Electrical Specifications

Parameters	Min	Typ	Max	Unit	Notes
Operating Frequency	3300	-----	7200	MHz	-----
Band Width	-----	4000	-----	MHz	-----
VSWR	-----	-----	3.5	-----	-----
Polarization	Linear			-----	-----
Azimuth Beam width	Omni-directional			-----	-----
Impedance	-----	50	-----	Ω	-----

Mechanical Specifications

Parameters	Specifications
Filter Dimension	8.0 x 6.0 x 1.2 mm
Mounting Type	SMD Mount
Material Type	Ceramic

Environmental Specifications

Parameters	Specifications
Operating Temperature Range	-40 °C ~ +100 °C
Storage Temperature Range	-40 °C ~ +100 °C
MSL level	1
ESD	N/A
Temperature range	25±5 °C
Relative Humidity range	90 ~ 95 %

UWB: 3.3 – 7.2 GHz Chip Antenna



ACG0806U

Request Samples



Check Inventory



8.0 x 6.0 x 1.2mm
RoHS Compliant
MSL Level = 1

Package Dimensions

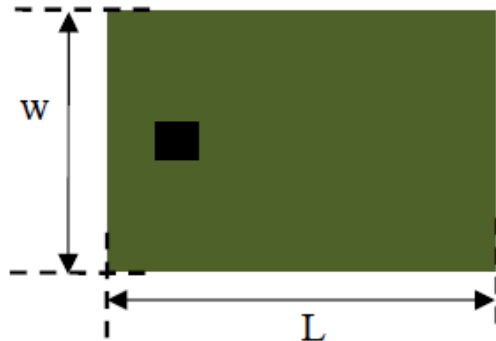

(Top View)

Number	Terminal Name
①	INPUT
②	NC

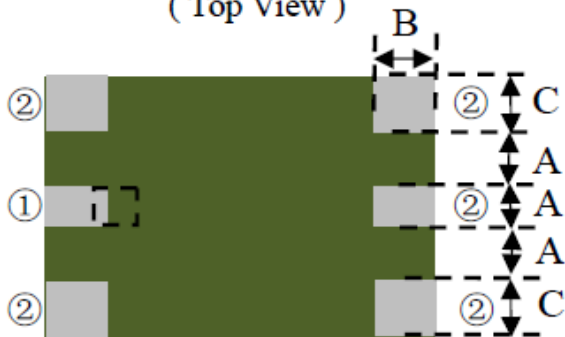

(Bottom View)



(Side View)



(Side View)

Symbol	L	W	T	A	B	C
Dimension (mm)	8.0±0.2	6.0±0.2	1.2±0.2	1.0±0.2	2.0±0.2	1.5±0.2

UWB: 3.3 – 7.2 GHz Chip Antenna



ACG0806U

Request Samples



Check Inventory



8.0 x 6.0 x 1.2mm
RoHS Compliant
MSL Level = 1

Footprint

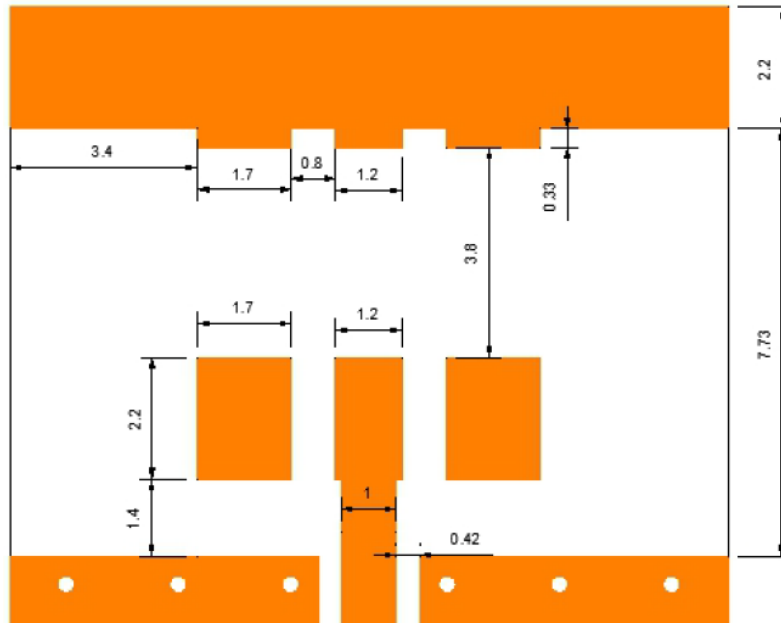

Unit:mm

Evaluation Board and Matching Circuits

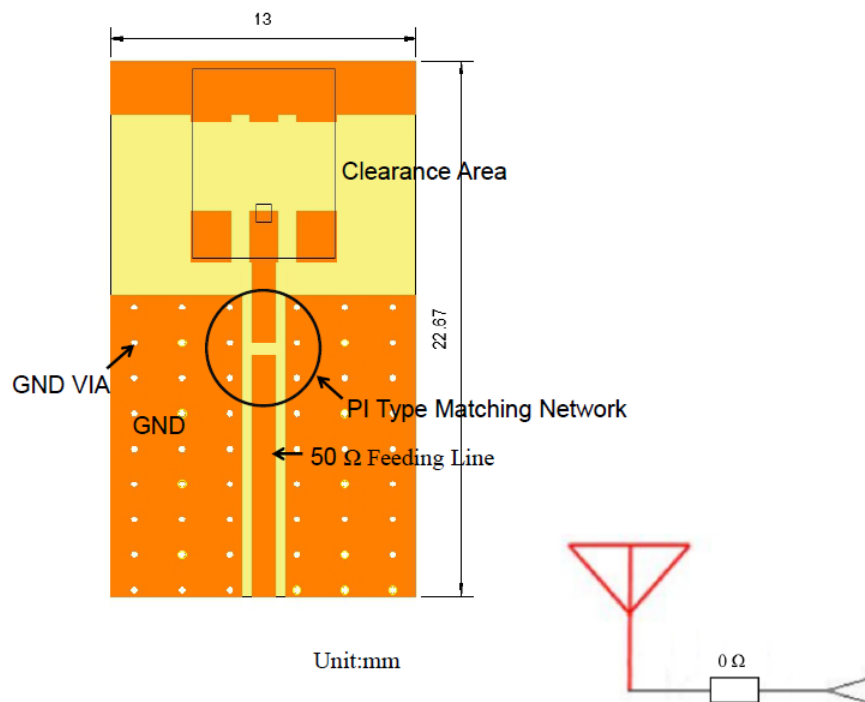

Unit:mm

UWB: 3.3 – 7.2 GHz Chip Antenna



ACG0806U

Request Samples



Check Inventory



8.0 x 6.0 x 1.2mm
RoHS Compliant
MSL Level = 1

Measurement Setup

The antenna measurements were all performed in free space with the antenna mounted on its evaluation board of size 13 x 23 mm, see image below.



UWB: 3.3 – 7.2 GHz Chip Antenna

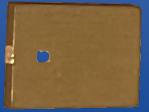

ACG0806U

Request Samples



Check Inventory



8.0 x 6.0 x 1.2mm
RoHS Compliant
MSL Level = 1

Impedance Characteristics – Return Loss

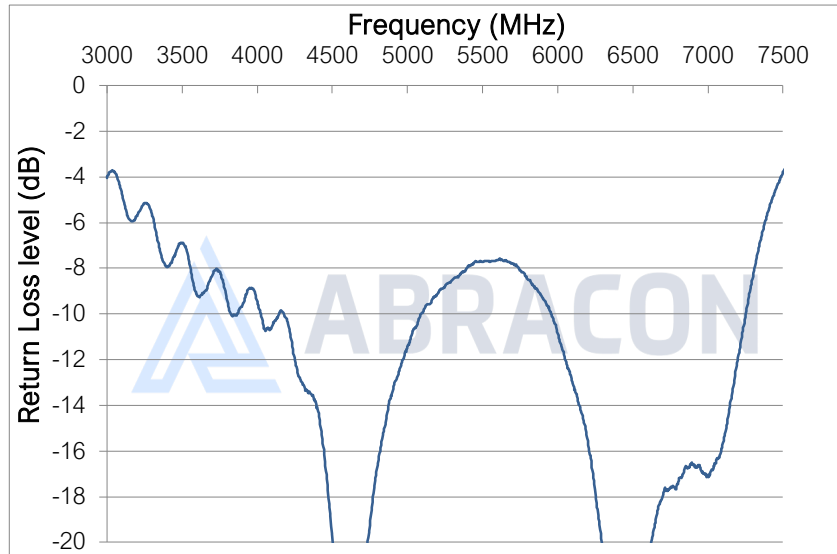

UWB: 3.3 – 7.2 GHz Chip Antenna



ACG0806U

Request Samples



Check Inventory



8.0 x 6.0 x 1.2mm
RoHS Compliant
MSL Level = 1

Radiation Characteristics – Total Efficiency

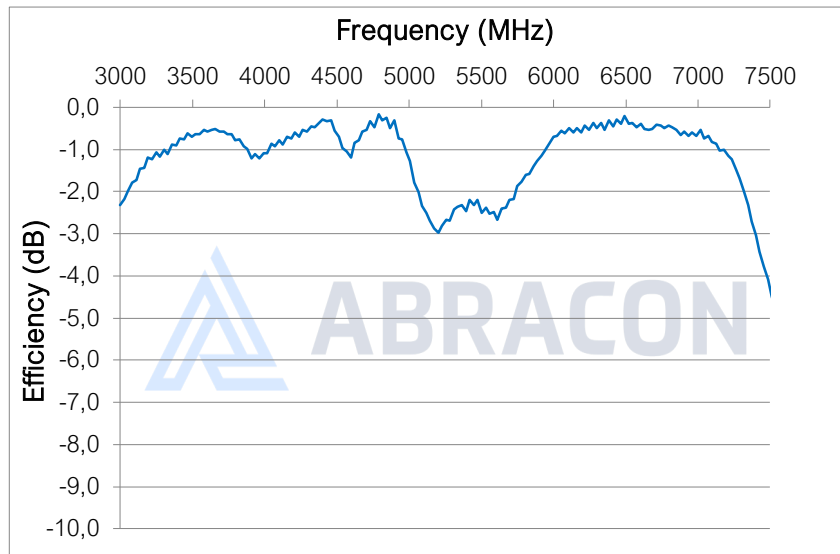

Radiation Characteristics – Maximum Gain

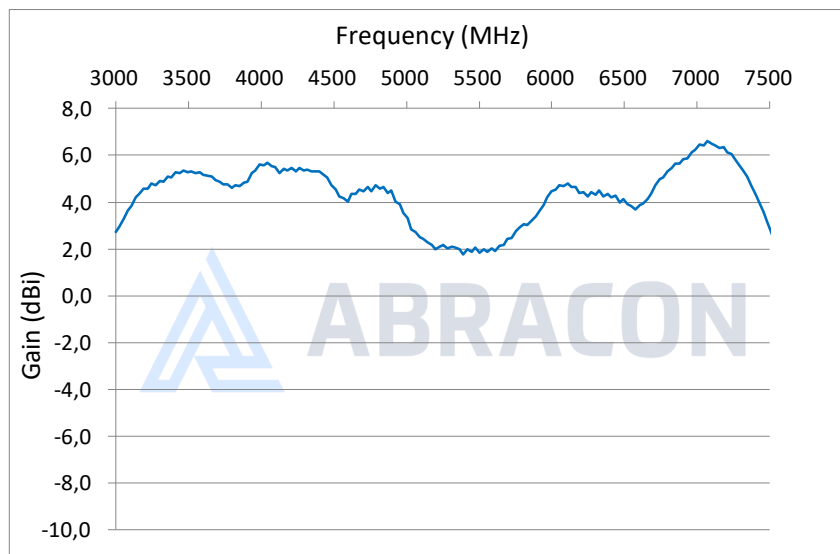

UWB: 3.3 – 7.2 GHz Chip Antenna

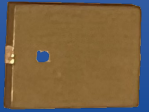

ACG0806U

Request Samples



Check Inventory



8.0 x 6.0 x 1.2mm
RoHS Compliant
MSL Level = 1

Radiation Characteristics – Group Delay

Two identical antennas were placed a distance d_{sep} apart in an anechoic chamber. The Group Delay, τ_{GD} , is then calculated from the transmission S-parameter (S12) by $\tau_{GD} = -\frac{1}{2 \cdot 360} \frac{\Delta\phi}{\Delta f}$, where $\Delta\phi$ is the change of phase over an aperture Δf . The maximum variation in group delay per channel, $\Delta_{max}\tau_{GD}$, can be found in the table below.

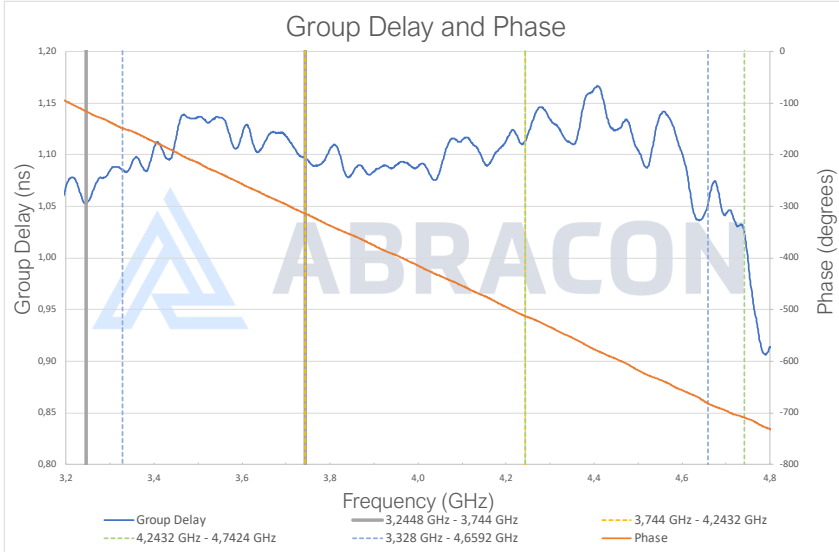

Used Parameters	
Distance d_{sep} (cm)	Aperture Δf (MHz)
50	220

Maximum Group Delay Variation			
UWB Ch.	Freq. Low (GHz)	Freq. High (GHz)	$\Delta_{max}\tau_{GD}$ (ps)
1	3,2448	3,744	86
2	3,744	4,2432	49
3	4,2432	4,7424	146
4	3,328	4,6592	130

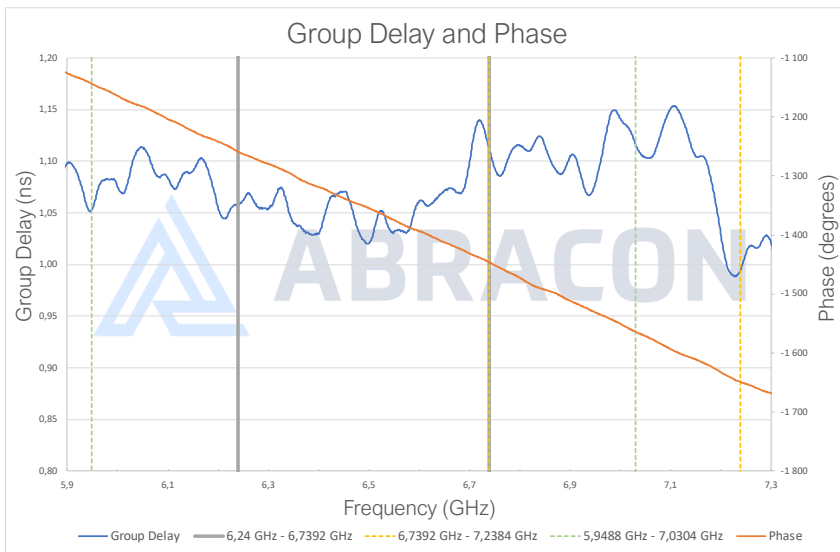

Used Parameters	
Distance d_{sep} (cm)	Aperture Δf (MHz)
50	220

Maximum Group Delay Variation			
UWB Ch.	Freq. Low (GHz)	Freq. High (GHz)	$\Delta_{max}\tau_{GD}$ (ps)
5	6,24	6,7392	120
6	6,7392	7,2384	165
7	5,9488	7,0304	130



5101 Hidden Creek Ln Spicewood TX 78669
Phone: 512-371-6159 | Fax: 512-351-8858
For terms and conditions of sales, please visit:
www.abracon.com

REVISED: 09-23-22

ABRACON IS
ISO9001-2015
CERTIFIED

UWB: 3.3 – 7.2 GHz Chip Antenna



ACG0806U

Request Samples



Check Inventory



8.0 x 6.0 x 1.2mm
RoHS Compliant
MSL Level = 1

Radiation Characteristics – 2D Pattern (7.24 GHz)

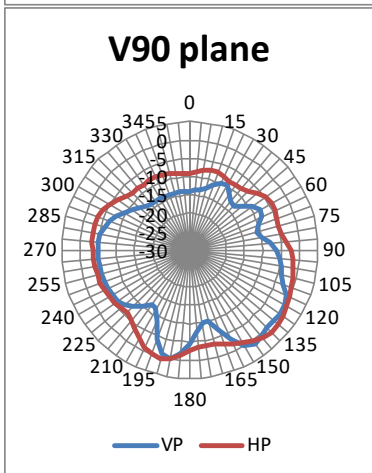
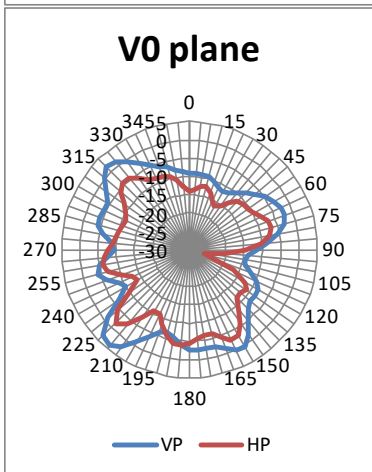
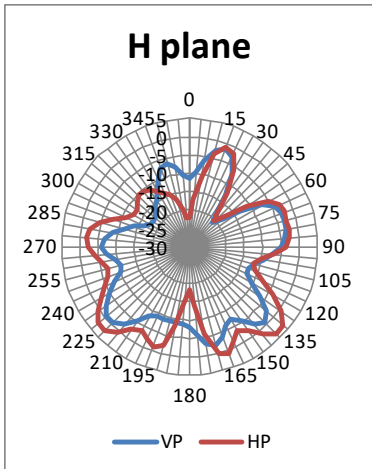

VP: Vertical Polarization
HP: Horizontal Polarization

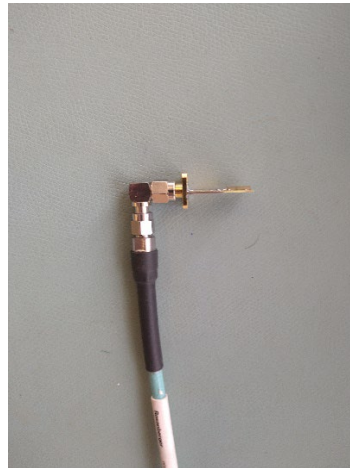
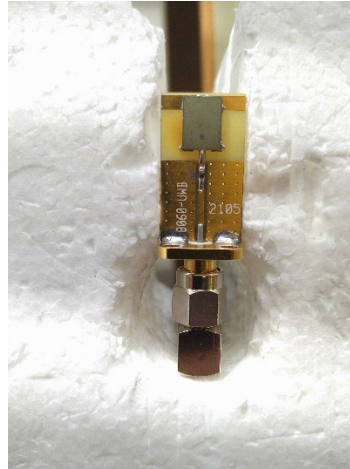

Unit: dBi

UWB: 3.3 – 7.2 GHz Chip Antenna



ACG0806U

Request Samples



Check Inventory



8.0 x 6.0 x 1.2mm
RoHS Compliant
MSL Level = 1

Radiation Characteristics – 2D Pattern (6.0 GHz)

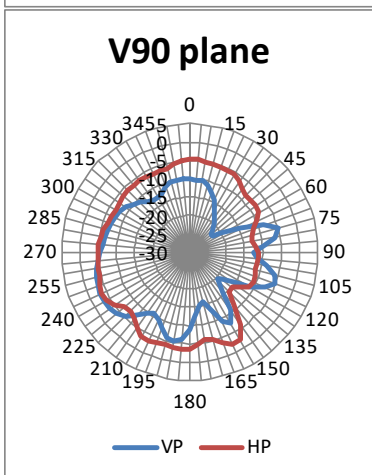
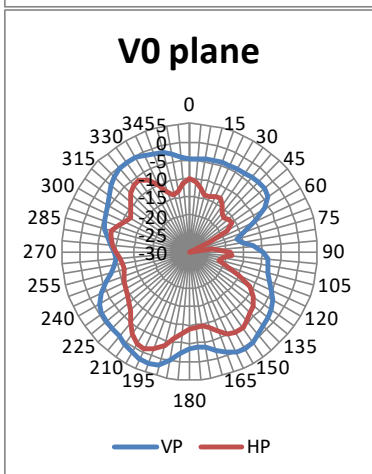
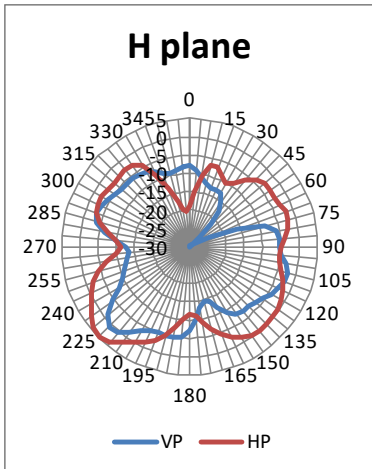

VP: Vertical Polarization
HP: Horizontal Polarization

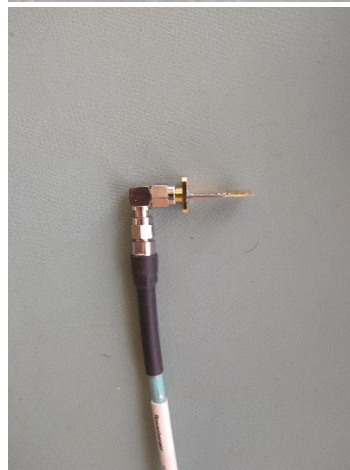
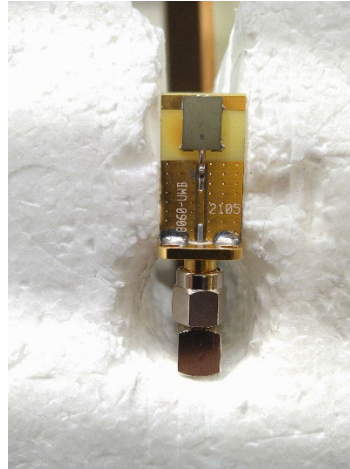

Unit: dBi

UWB: 3.3 – 7.2 GHz Chip Antenna



ACG0806U

Request Samples



Check Inventory



8.0 x 6.0 x 1.2mm
RoHS Compliant
MSL Level = 1

Radiation Characteristics – 2D Pattern (4.24 GHz)

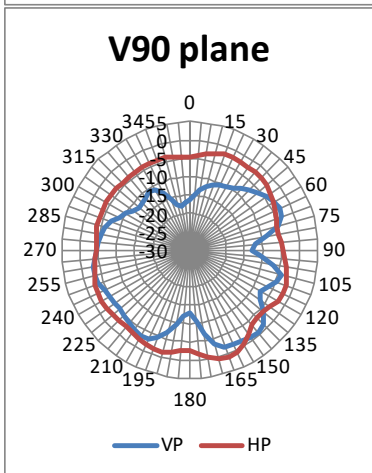
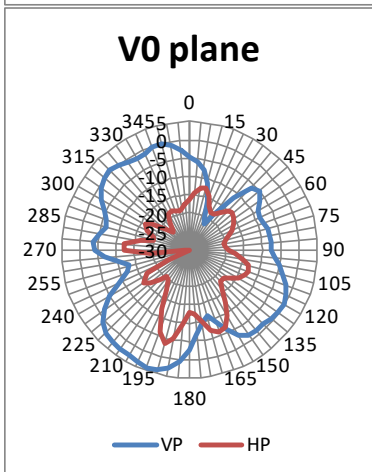
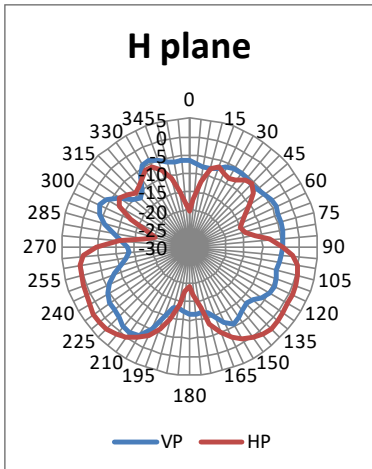

VP: Vertical Polarization
HP: Horizontal Polarization

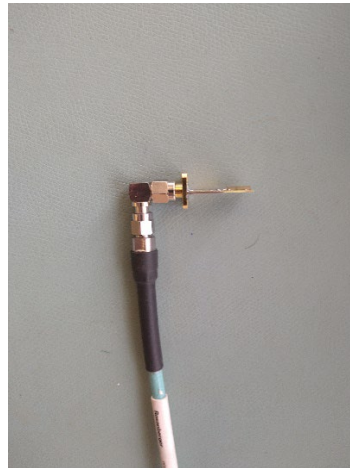
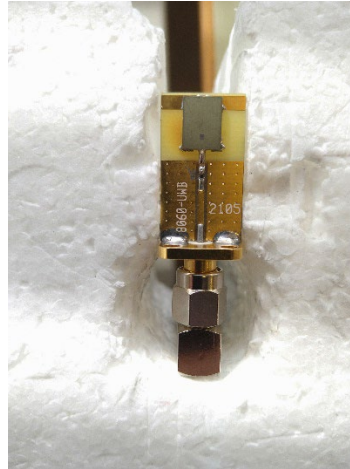

Unit: dBi

UWB: 3.3 – 7.2 GHz Chip Antenna



ACG0806U

Request Samples



Check Inventory



8.0 x 6.0 x 1.2mm
RoHS Compliant
MSL Level = 1

Radiation Characteristics – 2D Pattern (3.25 GHz)

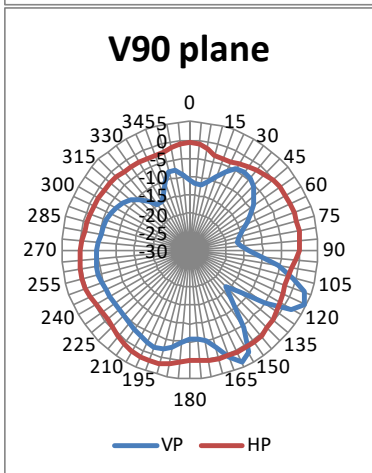
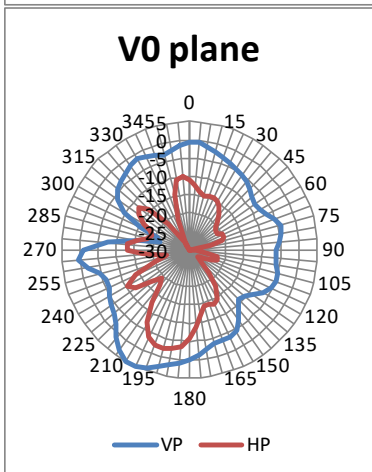
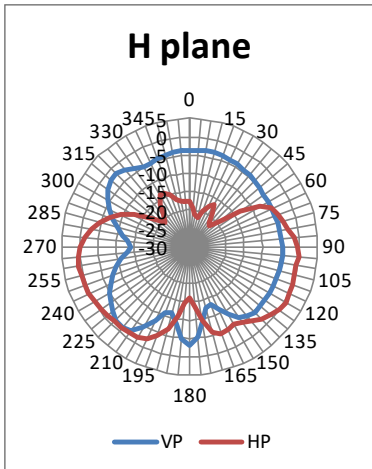

VP: Vertical Polarization
HP: Horizontal Polarization

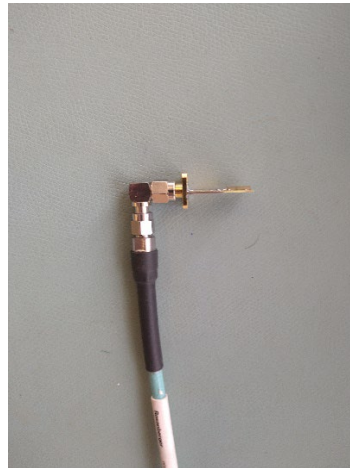
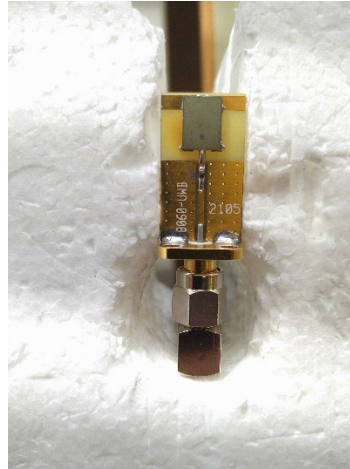

Unit: dBi

UWB: 3.3 – 7.2 GHz Chip Antenna



ACG0806U

Request Samples



Check Inventory



8.0 x 6.0 x 1.2mm
RoHS Compliant
MSL Level = 1

Soldering Profile: Reflow

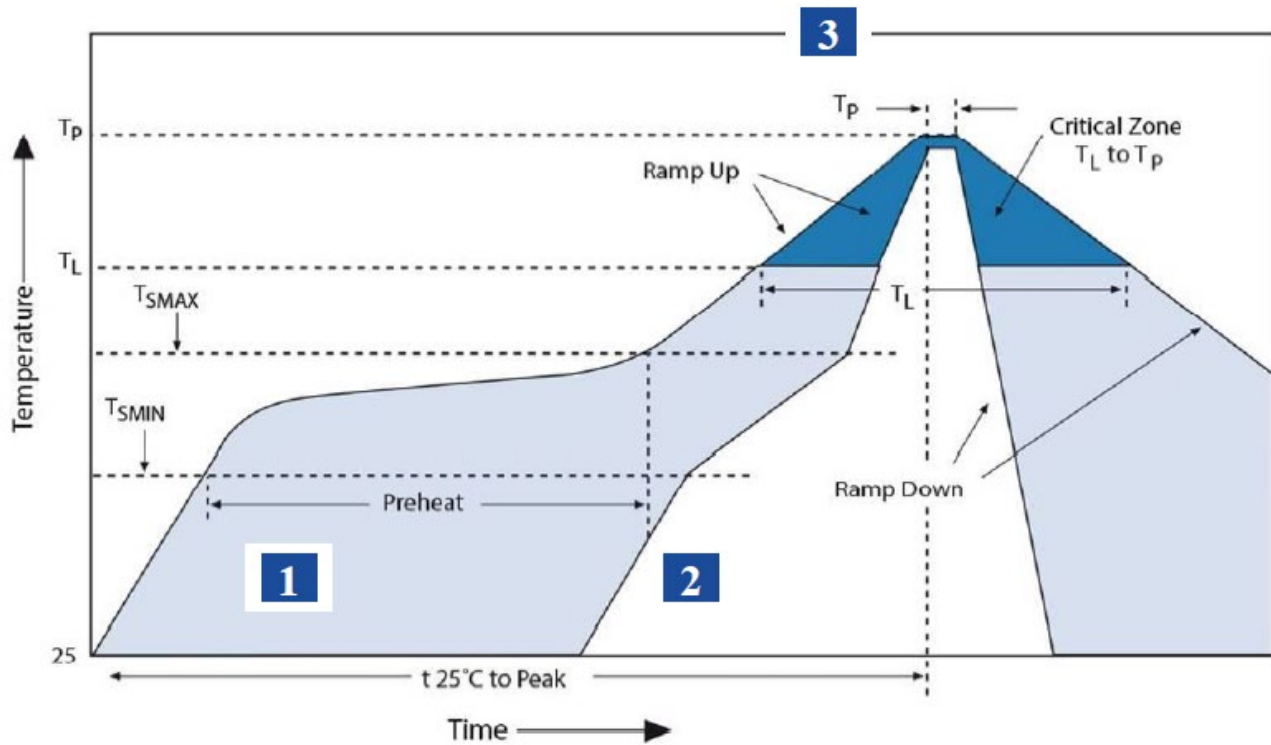

Zone	Description	Temperature	Time
1	Preheat / Soak	$T_{SMIN} \sim T_{SMAX}$ 160 – 180 °C	60 ~ 120 sec
2	Reflow	T_L 220 °C	60~80 sec
3	Peak heat	T_P 265 °C	5 sec (Max)

UWB: 3.3 – 7.2 GHz Chip Antenna



ACG0806U

Request Samples



Check Inventory



8.0 x 6.0 x 1.2mm
RoHS Compliant
MSL Level = 1

Packaging and Dimensions

1. Plastic Tape

Reserve a length of 150~200mm for the trailer of the carrier and 250~300 mm for the leader of the carrier and further 250mm of cover tape at the leading part of the carrier.

2. Reel (1500 pcs/Reel)

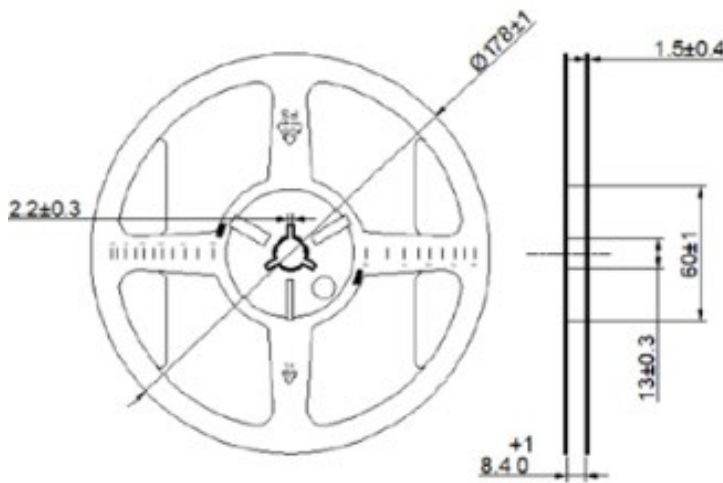

Unit : mm

ATTENTION: Abracon LLC's products are COTS – Commercial-Off-The-Shelf products; suitable for Commercial, Industrial and, where designated, Automotive Applications. Abracon's products are not specifically designed for Military, Aviation, Aerospace, Life-dependent Medical applications or any application requiring high reliability where component failure could result in loss of life and/or property. For applications requiring high reliability and/or presenting an extreme operating environment, written consent and authorization from Abracon LLC is required. Please contact Abracon LLC for more information.



5101 Hidden Creek Ln Spicewood TX 78669
Phone: 512-371-6159 | Fax: 512-351-8858
For terms and conditions of sales, please visit:
www.abracon.com

REVISED: 09-23-22

ABRACON IS
ISO9001-2015
CERTIFIED