

LAYOUT SHOWN AS EXAMPLE

Keying Shown as example

CHARACTERISTICS

- Standard : Based on MIL-DTL-38999 Series III
- Shell Material : Aluminium
- Shell Plating : Nickel
- Insulator : Thermoplastic
- Contacts : Copper Alloy
- Seals & Grommet : Silicon Elastomer
- Contact Plating : Gold over copper Alloy 0.8µm minimum
- Durability : 500 Mating cycles
- Delivered with Souriau contacts and Accessories
- Temperature Range : -65°C to +200°C
- Salt Spray : 48 hours
- Mass : 38.62 g ± 10%

Connector dimension	
Dim	Nominal
A	44.5±0.3
B	30.15+0.1/-0.15
R	32.5Max
S	41.3±0.4
W	2.2+0.9/-0.1
VV THREAD	M25x1-6g

SOURIAU shall not be liable for any non-conformity or damage due to a use of the Products which does not comply with the Specifications issued by either of the Parties or by a third party (professional recommendation, technical notice.)

Country	Jurisdiction & Control List
FR	Not Listed

PN: 8D717F99PE

A	30-09-2016	First Release	
ISS	DATE	Latest modification - by	MOD N°
Designed By:		Date:	CUSTOMER DRAWING
TITLE	Aluminium Receptacle 8D series		
SCALE		General linear Tolerances: ±--	NPRDS / PROJECT 859
NA			This document is the property of SOURIAU it must not be reproduced or communicated without permission
SOURIAU	WWW.SOURIAU.COM		
FORMAT A3	SOURIAU DRG N° 8D717F99PE-C		SHEET 1/2

BASIC SERIES:	8D	7	-	17	F	99	P	E	ORIENTATION : E
SHELL TYPE	: Jam nut Receptacle								
CONTACT TYPE	: Standard Crimp Contact								
SHELL SIZE	: 17								
PLATING	: F = Nickel								
	CONTACT LAYOUT : 17-99								

H G F E D C B A

Contact Layout

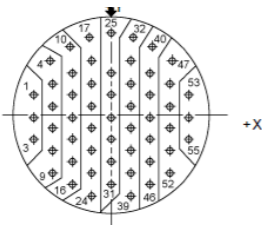

Contacts (Insert arrangement 17-35)					
Contact position ID	Location		Contact position ID	Location	
	X-axis (mm)	Y-axis (mm)		X-axis (mm)	Y-axis (mm)
1	-312 (7.92)	+086 (2.18)	29	.000 (0.00)	-.094 (2.39)
2	-312 (7.92)	-.004 (0.10)	30	.000 (0.00)	-.184 (4.67)
3	-312 (7.92)	-.094 (2.39)	31	.000 (0.00)	-.274 (6.96)
4	-.242 (6.15)	+221 (5.61)	32	+089 (2.26)	+316 (8.03)
5	-.234 (5.94)	+131 (3.33)	33	+078 (1.98)	+221 (5.61)
6	-.234 (5.94)	+041 (1.04)	34	+078 (1.98)	+131 (3.33)
7	-.234 (5.94)	-.049 (1.24)	35	+078 (1.98)	+041 (1.04)
8	-.234 (5.94)	-.139 (3.53)	36	+078 (1.98)	-.049 (1.24)
9	-.234 (5.94)	-.229 (5.82)	37	+078 (1.98)	-.139 (3.53)
10	-.172 (4.37)	+279 (7.09)	38	+078 (1.98)	-.229 (5.82)
11	-.156 (3.96)	+176 (4.47)	39	+078 (1.98)	-.319 (8.10)
12	-.156 (3.96)	+086 (2.18)	40	+172 (4.37)	+279 (7.09)
13	-.156 (3.96)	-.004 (0.10)	41	+156 (3.96)	+176 (4.47)
14	-.156 (3.96)	-.094 (2.39)	42	+156 (3.96)	+086 (2.18)
15	-.156 (3.96)	-.184 (4.67)	43	+156 (3.96)	-.004 (0.10)
16	-.156 (3.96)	-.274 (6.96)	44	+156 (3.96)	-.094 (2.39)
17	-.089 (2.26)	+316 (8.03)	45	+156 (3.96)	-.184 (4.67)
18	-.078 (1.98)	+221 (5.61)	46	+156 (3.96)	-.274 (6.96)

Contacts (Insert arrangement 17-35)					
Contact position ID	Location		Contact position ID	Location	
	X-axis (mm)	Y-axis (mm)		X-axis (mm)	Y-axis (mm)
19	-.078 (1.98)	+131 (3.33)	47	+242 (6.15)	+221 (5.61)
20	-.078 (1.98)	+041 (1.04)	48	+234 (5.94)	+131 (3.33)
21	-.078 (1.98)	-.049 (1.24)	49	+234 (5.94)	+041 (1.04)
22	-.078 (1.98)	-.139 (3.53)	50	+234 (5.94)	-.049 (1.24)
23	-.078 (1.98)	-.229 (5.82)	51	+234 (5.94)	-.139 (3.53)
24	-.078 (1.98)	-.319 (8.10)	52	+234 (5.94)	-.229 (5.82)
25	.000 (0.00)	+329 (8.36)	53	+312 (7.92)	+086 (2.18)
26	.000 (0.00)	+176 (4.47)	54	+312 (7.92)	-.004 (0.10)
27	.000 (0.00)	+086 (2.18)	55	+312 (7.92)	-.094 (2.39)
28	.000 (0.00)	-.004 (0.10)	---	---	---

Shell size	Arrangement no.	Number of contacts	Size contacts	Service rating	Contact location	Supersedes
17	-35	55	22D	M	All	MS27529-35

Panel cutout

JAM NUT RECEPTACLE (TYPE 7)

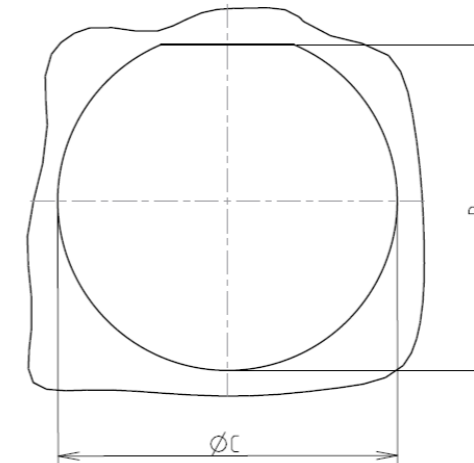

Dim	Nominal
B	30.73+0/-0.25
ØC	32.01+0.25/-0

SOURIAU shall not be liable for any non-conformity or damage due to a use of the Products which does not comply with the Specifications issued by either of the Parties or by a third party (professional recommendation, technical notice.)

Country	Jurisdiction & Control List
FR	Not Listed

PN: 8D717F99PE

A	30-09-2016	First Release	
ISS	DATE	Latest modification - by	MOD N°
Designed By:		Date:	CUSTOMER DRAWING
TITLE	Aluminium Receptacle 8D series		
SCALE		General linear Tolerances: ±--	NPRDS / PROJECT 859
SOURIAU	WWW.SOURIAU.COM		This document is the property of SOURIAU it must not be reproduced or communicated without permission
FORMAT A3	SOURIAU DRG N° 8D717F99PE-C		SHEET 2/2

H G F E D C B A