

THIS DOCUMENT IS SUBJECT TO CHANGE WITHOUT NOTICE. IT IS CONFIDENTIAL AND A PROPERTY OF AMPHENOL LTW. DISCLOSURE TO THIRD PARTY HAS TO BE AUTHORIZED BY AMPHENOL LTW.

REV.	ECN NO.	DATE	SIGN	DESCRIPTION
A		2022-06-22	Jiahe Lin	Rev.01 To Rev.A
B	C221046	2022-07-10	Allen Pan	$\triangle B \times 1$

MSDS-XXPMMJ-SF8AXX  
 XX: No. Of Pin  
 XX:L=0~5Meters  
 A5:L=0.5Meters  
 01:L=1Meters  
 02:L=2Meters  
 ...  
 05:L=5Meters

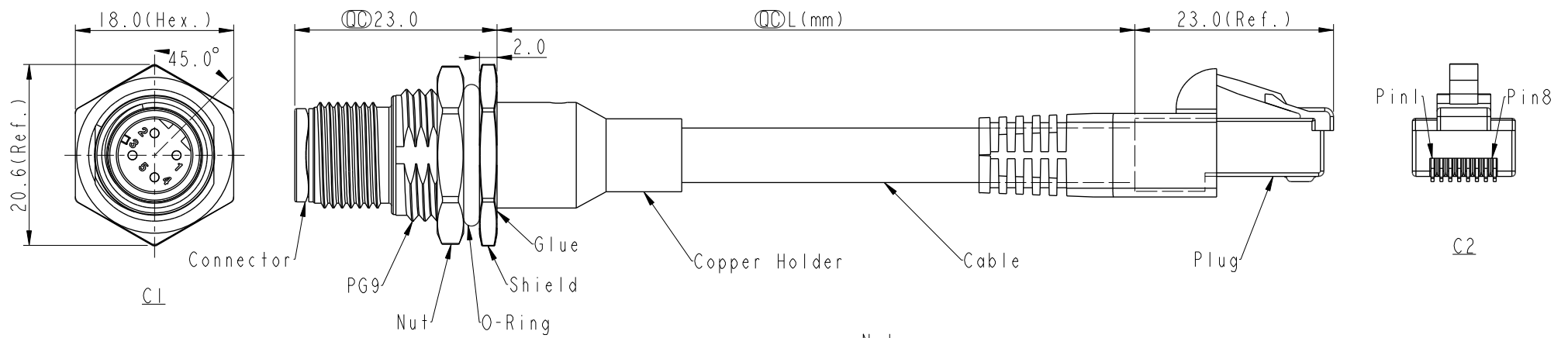



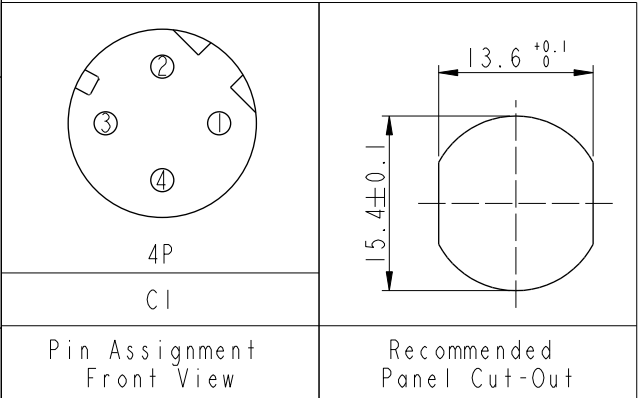





Note:  
 \* RoHS Compliant  
 \*  $\text{⌀}$  Important Dimension  
 \* C1  
 Waterproof Rate: IPX8, Unmated 1m/24h  
 Housing: Thermoplastic, Black  
 Pin: Copper Alloy, Gold Plated  
 O-Ring: Rubber, Black  
 Shield: Metal  
 Nut: Metal  
 \* C2  
 Waterproof Rate: Non-Waterproof  
 Plug: RJ45, Shielded  
 \* For panel thickness max: 4.5mm  
 \* Nut is packed separately in pe bag  
 \*  $\triangle B$  Cable: CAT-5E, 22#\*2P+AL/MY+D, OD=6.2mm, PU Jacket, Black  
 \* Cable length tolerance: 0.5M < L ≤ 1M: +60/-0 mm  
 1M < L ≤ 3M: +120/-0 mm  
 3M < L ≤ 5M: +160/-0 mm



UNIT:mm	$\text{⌀}$	$\text{⌀}$	TITLE N SEN, M12 D -SHLD, SCREW RECEPTACLE, M, M, RJ PLUG		
TOLERANCE .X ±0.25 .XX ±0.1 .XXX ±0.05 ANGLES ±1°	SCALE 2:1	SIZE A4	SHEET 1	OF 2	REV. B
		WC-REV.	$\text{⌀}$ : Inspection item		

<b>Amphenol LTW</b> 安費諾亮泰企業股份有限公司		ITEM NO	DRAWN BY	DATE
		DWG NO MSDS-XXPMMJ-SF8AXX	Jiahe Lin	2022-06-22
		CUSTOMER	CHECKED BY	DATE
		ALTW	Allen Pan	2022-06-22
			APPROVED BY	DATE
			Fred Lee	2022-06-22

THIS DOCUMENT IS SUBJECT TO CHANGE WITHOUT NOTICE. IT IS CONFIDENTIAL AND A PROPERTY OF Amphenol LTW. DISCLOSURE TO THIRD PARTY HAS TO BE AUTHORIZED BY Amphenol LTW.

	2	3	4	5	6	7	8																																											
F																																																		
E																																																		
D																																																		
C																																																		
B	<table border="1" style="width: 100%; border-collapse: collapse;"> <tr> <td style="width: 10%;">Shield</td> <td style="width: 20%;">Drain</td> <td style="width: 10%;">地線</td> <td style="width: 10%;">Shield</td> <td colspan="3"></td> </tr> <tr> <td>4</td> <td>Green</td> <td>綠</td> <td>6</td> <td rowspan="2" style="text-align: center;">Twist</td> <td colspan="2"></td> </tr> <tr> <td>2</td> <td>White/Green</td> <td>白/綠</td> <td>3</td> </tr> <tr> <td>3</td> <td>Orange</td> <td>橘</td> <td>2</td> <td rowspan="2" style="text-align: center;">Twist</td> <td colspan="2"></td> </tr> <tr> <td>1</td> <td>White/Orange</td> <td>白/橘</td> <td>1</td> </tr> <tr> <td>C1</td> <td colspan="2" style="text-align: center;">Wire Color</td> <td>C2</td> <td colspan="3"></td> </tr> <tr> <td colspan="7" style="text-align: center;">Pin Out</td> </tr> </table>							Shield	Drain	地線	Shield				4	Green	綠	6	Twist			2	White/Green	白/綠	3	3	Orange	橘	2	Twist			1	White/Orange	白/橘	1	C1	Wire Color		C2				Pin Out						
Shield	Drain	地線	Shield																																															
4	Green	綠	6	Twist																																														
2	White/Green	白/綠	3																																															
3	Orange	橘	2	Twist																																														
1	White/Orange	白/橘	1																																															
C1	Wire Color		C2																																															
Pin Out																																																		
A	<table border="1" style="width: 100%; border-collapse: collapse;"> <tr> <td style="width: 10%;">UNIT:mm</td> <td style="width: 10%; text-align: center;"></td> <td style="width: 10%; text-align: center;"></td> <td style="width: 20%;">TITLE N SEN, M12 D -SHLD, SCREW RECEPTACLE, M, M, RJ PLUG</td> <td style="width: 20%; text-align: center;"><b>Amphenol LTW</b> 安費諾亮泰企業股份有限公司</td> <td style="width: 10%;">ITEM NO</td> <td style="width: 10%;">DRAWN BY Jiahe Lin</td> <td style="width: 10%;">DATE 2022-06-22</td> </tr> <tr> <td colspan="3">TOLERANCE .X ±0.25 .XX ±0.1 .XXX ±0.05 ANGLES ±1°</td> <td>SCALE 1:1</td> <td>SIZE A4</td> <td>SHEET 2 OF 2</td> <td>DWG NO MSDS-XXPMMJ-SF8AXX</td> <td>CHECKED BY Allen Pan</td> <td>DATE 2022-06-22</td> </tr> <tr> <td colspan="3"></td> <td>REV. B</td> <td>WC-REV.</td> <td>: Inspection item</td> <td>CUSTOMER ALTW</td> <td>APPROVED BY Fred Lee</td> <td>DATE 2022-06-22</td> </tr> </table>							UNIT:mm			TITLE N SEN, M12 D -SHLD, SCREW RECEPTACLE, M, M, RJ PLUG	<b>Amphenol LTW</b> 安費諾亮泰企業股份有限公司	ITEM NO	DRAWN BY Jiahe Lin	DATE 2022-06-22	TOLERANCE .X ±0.25 .XX ±0.1 .XXX ±0.05 ANGLES ±1°			SCALE 1:1	SIZE A4	SHEET 2 OF 2	DWG NO MSDS-XXPMMJ-SF8AXX	CHECKED BY Allen Pan	DATE 2022-06-22				REV. B	WC-REV.	 : Inspection item	CUSTOMER ALTW	APPROVED BY Fred Lee	DATE 2022-06-22																	
UNIT:mm			TITLE N SEN, M12 D -SHLD, SCREW RECEPTACLE, M, M, RJ PLUG	<b>Amphenol LTW</b> 安費諾亮泰企業股份有限公司	ITEM NO	DRAWN BY Jiahe Lin	DATE 2022-06-22																																											
TOLERANCE .X ±0.25 .XX ±0.1 .XXX ±0.05 ANGLES ±1°			SCALE 1:1	SIZE A4	SHEET 2 OF 2	DWG NO MSDS-XXPMMJ-SF8AXX	CHECKED BY Allen Pan	DATE 2022-06-22																																										
			REV. B	WC-REV.	 : Inspection item	CUSTOMER ALTW	APPROVED BY Fred Lee	DATE 2022-06-22																																										
	2	3	4	5	6	7	8																																											