



Mag Layers USA, INC

Specification Sheet

P/N : MCM-1513M-SERIES-RU

Products:

[Molded Power Chokes](#)

[Multilayer Chip Inductors](#)

[Lan Transformer](#)

[RF Passive / Antennas](#)

[Automotive](#)

Certifications:

[ISO9001](#)

[IATF16949](#)

[ISO14001](#)

[QC080000](#)

US Office

5406 Bolsa Ave.,
Huntington Beach, CA 92649
(714) 898-8377

Contact Us

www.maglayersusa.com
info@maglayersusa.com

I. SCOPE :

This specification applies to the Pb Free high current type SMD Common mode filter for MCM-1513M-SERIES

PRODUCT IDENTIFICATION

MCM - 1513M - 701-RU

① ② ③

① Product Code

② Dimensions Code

③ Impedance Code

(1) SHAPES AND DIMENSIONS

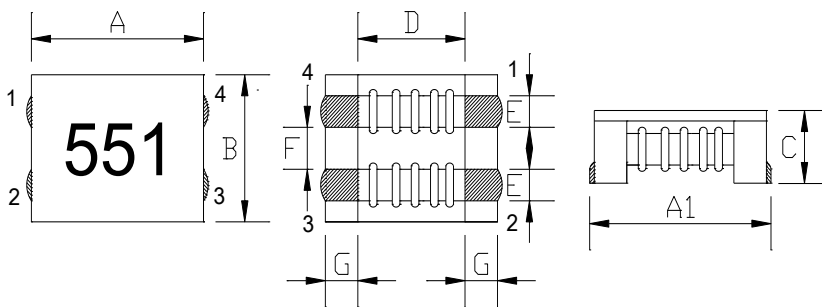

A:	15.0±0.5	mm
A1:	15.0±0.6	mm
B:	13.0±0.4	mm
C:	6.0 Max.	mm
D:	9.0 Typ.	mm
E:	2.7±0.2	mm
F:	3.8±0.2	mm
G:	3.0±0.2	mm

(2) ELECTRICAL SPECIFICATIONS

SEE TABLE 1

TEST INSTRUMENTS

Z : HP 4291B IMPEDANCE ANALYZER (or equivalent)

RDC : CHROMA MODEL 16502 MILLIOHM METER (or equivalent)

(3) CHARACTERISTICS

(3)-1 Operate temperature range -40°C ~ +125°C

(Including self temp. rise)

(3)-2 Storage temperature range -40°C ~ +125°C

TABLE 1

MAGLAYERS PT/NO.	Impedance(Ω) at 100MHz		Resistance RDC(m Ω) (1 line)	Rated Current (A) Max.	Insulation Resistance (M Ω) Min.	Rated Voltage (V)Max.
	Min.	Typ.				
MCM-1513M-301-RU	250	300	4.7 Max.	13	10	80
MCM-1513M-551-RU	450	550	3.8 \pm 20%	10	10	80
MCM-1513M-701-RU	500	700	7.0 Max.	10	10	80

Rated Current : Based on temperature rise (ΔT : 40 $^{\circ}$ C TYP.)

CIRCUIT DIAGRAM

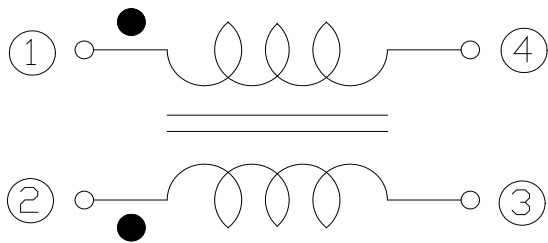

(4) RELIABILITY TEST METHOD
MECHANICAL

TEST ITEM	SPECIFICATION	TEST DETAILS
Solder ability	The product shall be connected to the test circuit board by the fillet (the height is 0.2mm).	Apply cream solder to the printed circuit board . Refer to clause 8 for Reflow profile.
Resistance to Soldering heat (reflow soldering)	There shall be no damage or problems.	<p>Temperature profile of reflow soldering</p> <p>The specimen shall be passed through the reflow oven with the condition shown in the above profile for 1 time. The specimen shall be stored at standard atmospheric conditions for 1 hour, after which the measurement shall be made.</p>
Terminal strength	The terminal electrode and the ferrite must not be damaged.	<p>Solder a chip to test substrate , and then laterally apply a load 9.8N in the arrow direction.</p>
Strength on PC board bending	The terminal electrode and the ferrite must not be damaged.	<p>Solder a chip to test substrate and then apply a load.</p> <p>Test board:FR4 100×40×1mm Fall speed:1mm/sec. Dimensions in mm</p>
High temperature resistance	<p>Impedance:Within±20% of the initial value.</p> <p>Insulation resistance and DC resistance on the specification(refer to clause 2-1) shall be met.</p> <p>The terminal electrode and the ferrite must not be damaged.</p>	<p>After the samples shall be soldered onto the test circuit board,the test shall be done.</p> <p>Measurement : After placing for 24 hours min.</p> <p>Temperature : +125±2°C</p> <p>Applied voltage : Rated voltage</p> <p>Applied current : Rated current</p> <p>Testing time : 500±12 hours</p>

(4) RELIABILITY TEST METHOD

MECHANICAL

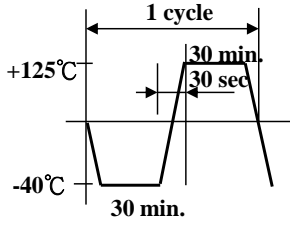
TEST ITEM	SPECIFICATION	TEST DETAILS
Humidity resistance	<p>Impedance: Within $\pm 20\%$ of the initial value.</p> <p>Insulation resistance and DC resistance on the specification (refer to clause 2-1) shall be met.</p> <p>The terminal electrode and the ferrite must not be damaged.</p>	<p>After the samples shall be soldered onto the test circuit board, the test shall be done.</p> <p>Measurement : After placing for 24 hours min.</p> <p>Temperature : $+60 \pm 2^\circ\text{C}$, Humidity : 90 to 95 %RH</p> <p>Applied voltage : Rated voltage</p> <p>Applied current : Rated current</p> <p>Testing time : 500 ± 12 hours</p>
Thermal shock	<p>Impedance: Within $\pm 20\%$ of the initial value.</p> <p>Insulation resistance and DC resistance on the specification (refer to clause 2-1) shall be met.</p> <p>The terminal electrode and the ferrite must not be damaged.</p>	
Low temperature storage	<p>Impedance: Within $\pm 20\%$ of the initial value.</p> <p>Insulation resistance and DC resistance on the specification (refer to clause 2-1) shall be met.</p> <p>The terminal electrode and the ferrite must not be damaged.</p>	<p>After the samples shall be soldered onto the test circuit board, the test shall be done.</p> <p>Measurement : After placing for 24 hours min.</p> <p>Temperature : $-40 \pm 2^\circ\text{C}$</p> <p>Testing time : 500 ± 12 hours</p>
Vibration	<p>Impedance: Within $\pm 20\%$ of the initial value.</p> <p>Insulation resistance and DC resistance on the specification (refer to clause 2-1) shall be met.</p> <p>The terminal electrode and the ferrite must not be damaged.</p>	<p>After the samples shall be soldered onto the test circuit board, the test shall be done.</p> <p>Frequency : 10 to 55 Hz</p> <p>Amplitude : 1.52 mm</p> <p>Dimension and times : X , Y and Z directions for 2 hours each.</p>
Solderability	<p>New solder More than 75%</p>	<p>Flux (rosin, isopropyl alcohol {JIS-K-1522}) shall be coated over the whole of the sample before hard, the sample shall then be preheated for about 2 minutes in a temperature of $130 \sim 150^\circ\text{C}$ and after it has been immersed to a depth 0.5mm below for 3 ± 0.2 seconds fully in molten solder M705 with a temperature of $245 \pm 2^\circ\text{C}$. More than 75% of the electrode sections shall be covered with new solder smoothly when the sample is taken out of the solder bath.</p>

(5) LAND DIMENSION (Ref.)

PCB: GLASS EPOXY t=1.6mm

(5)-1 LAND PATTERN DIMENSIONS

(STANDARD PATTERN) Unit:mm

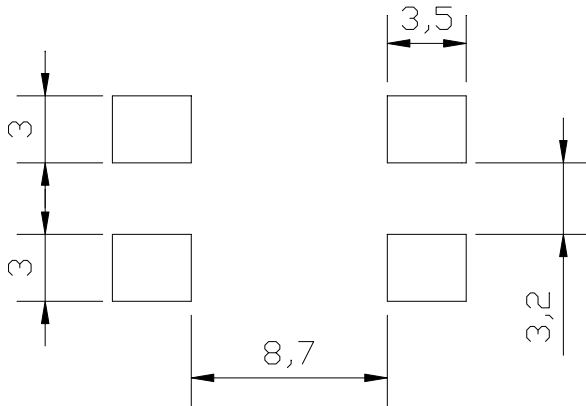

(6) TEST EQUIPMENT

(6)-1 Impedance

Measured by using HP4291B RF Impedance Analyzer.

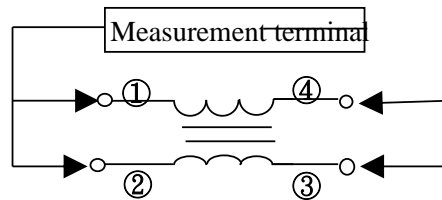

(6)-2 DC Resistance

Measured by using Chroma 16502 milliohm meter.

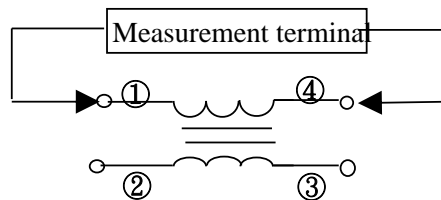

(6)-3 Insulation Resistance

Measured by using Chroma 19073

Measurement voltage : 50v ,Measurement time : 60 sec.

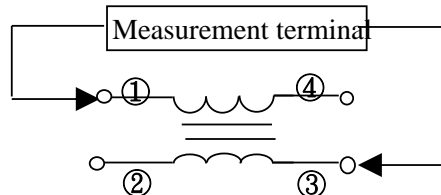

MAG.LAYERS

(6) PACKAGING

(6)-1 CARRIER TAPE DIMENSIONS (mm)

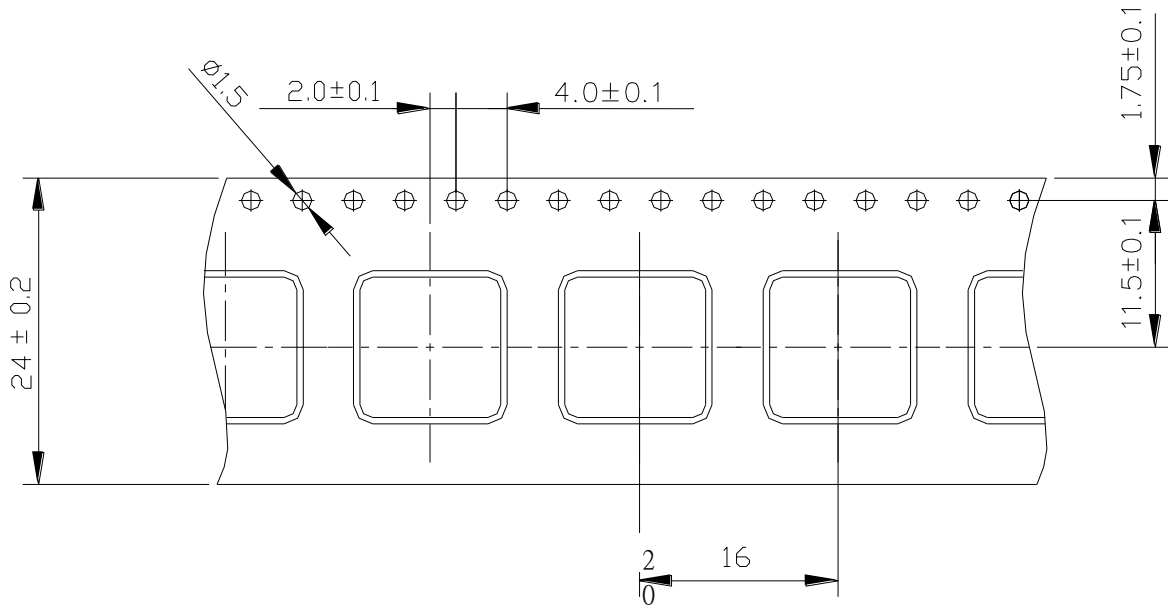

(6)-2 TAPING DIMENSIONS (mm)

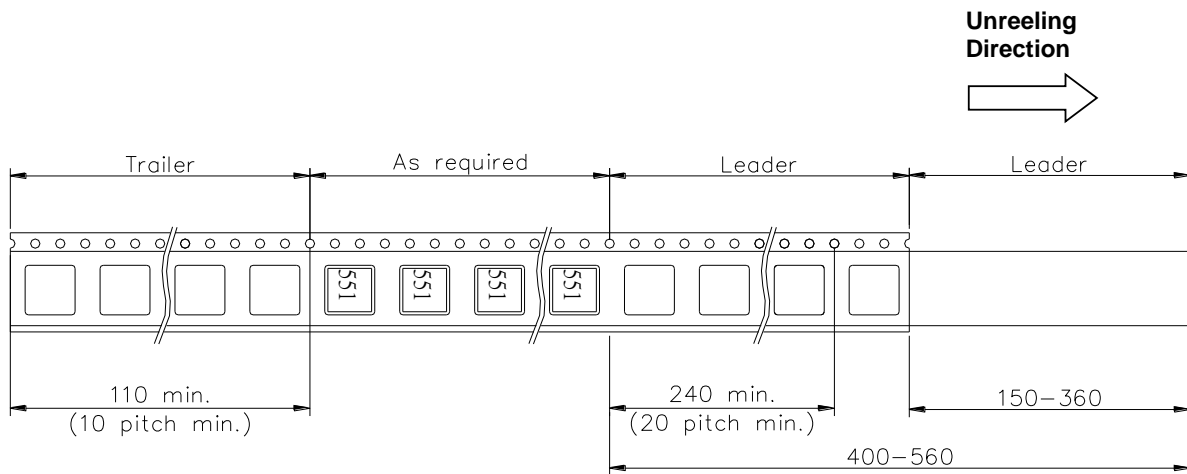

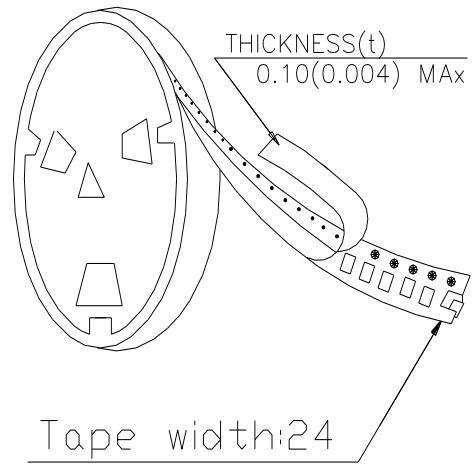
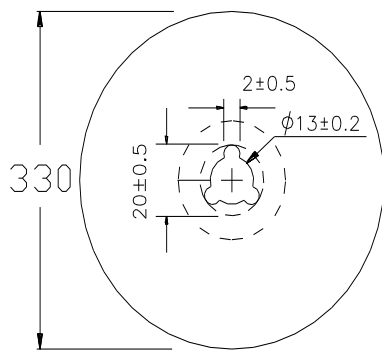

450 pcs/Reel

The products are packaged so that no damage will be sustained.

Please note that the contents may change without any prior notice due to reasons such as upgrading.



MAG.LAYERS

TYPICAL ELECTRICAL CHARACTERISTICS

Impedance VS. Frequency

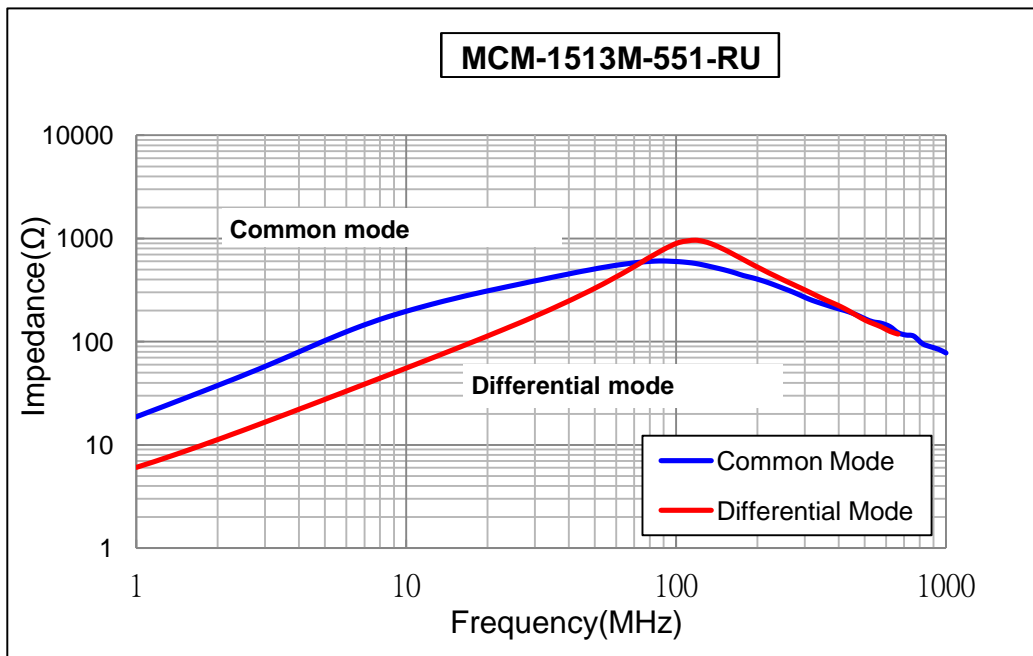
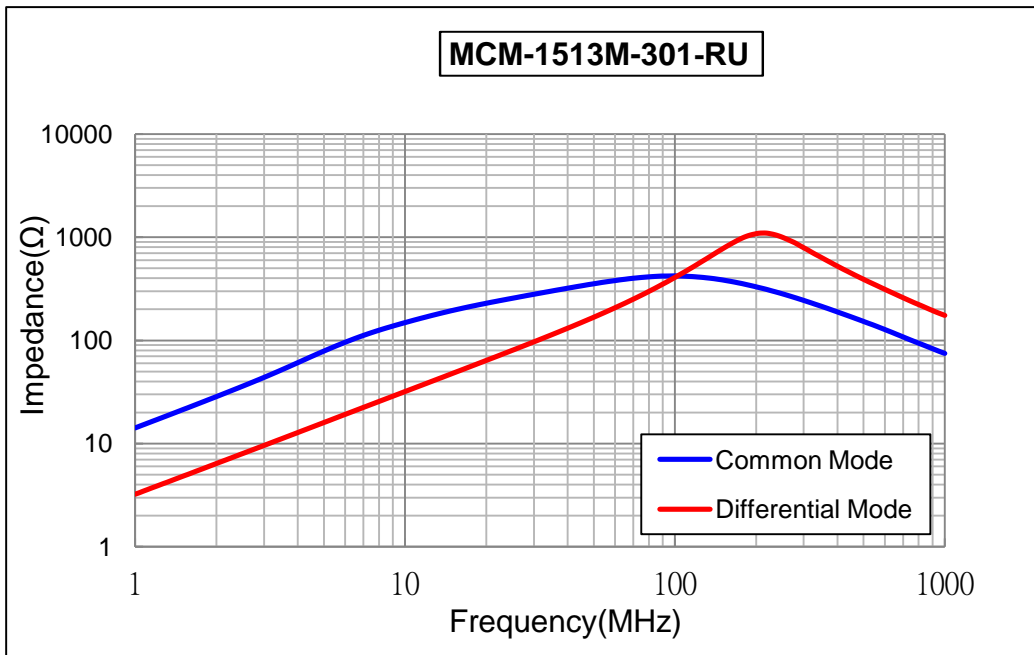

TYPICAL ELECTRICAL CHARACTERISTICS

Impedance VS. Frequency

