

MOSFET BASED DC SOLID-STATE RELAY

- ▶ Latest MOSFET technology generation.
- ▶ Ultra low on-state resistance.
- ▶ Low output leakage current.
- ▶ Low control current consumption.
- ▶ Built-in overvoltage protection
- ▶ Reverse protected triggered control input to avoid linear control risks
- ▶ No radiated or conducted disturbances
- ▶ Touch protected housing IP20



SOM040200



Control voltage range	3.5-32VDC
Max. permanent output voltage	110VDC
Max. load current with heatsink	40ADC

Load voltage range	Load current range	Control input voltage range	In & case / Out Insulation	Connections	Dimensions (WxHxD)	Weight
5-110VDC	Up to 40A (with heatsink)	3.5-32VDC	2.5kV	Screw terminals	45 x 58.5 x 30	80g

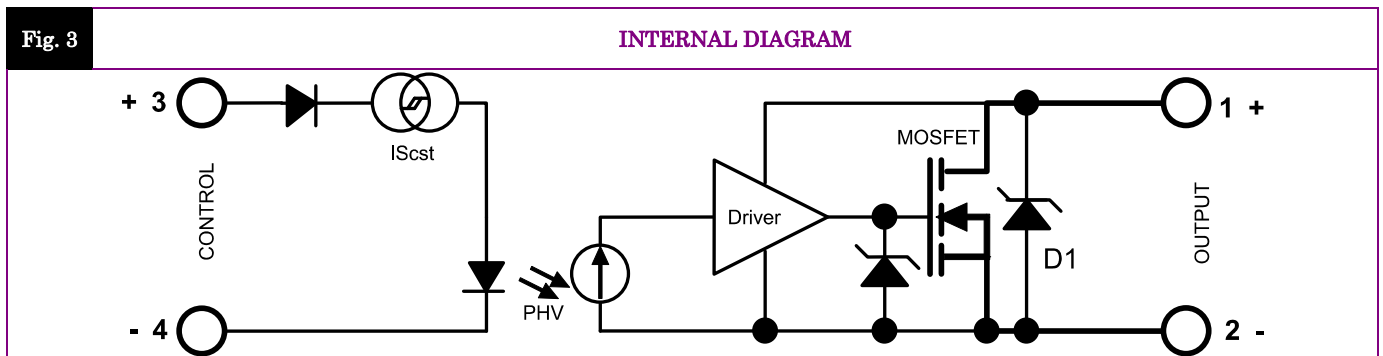
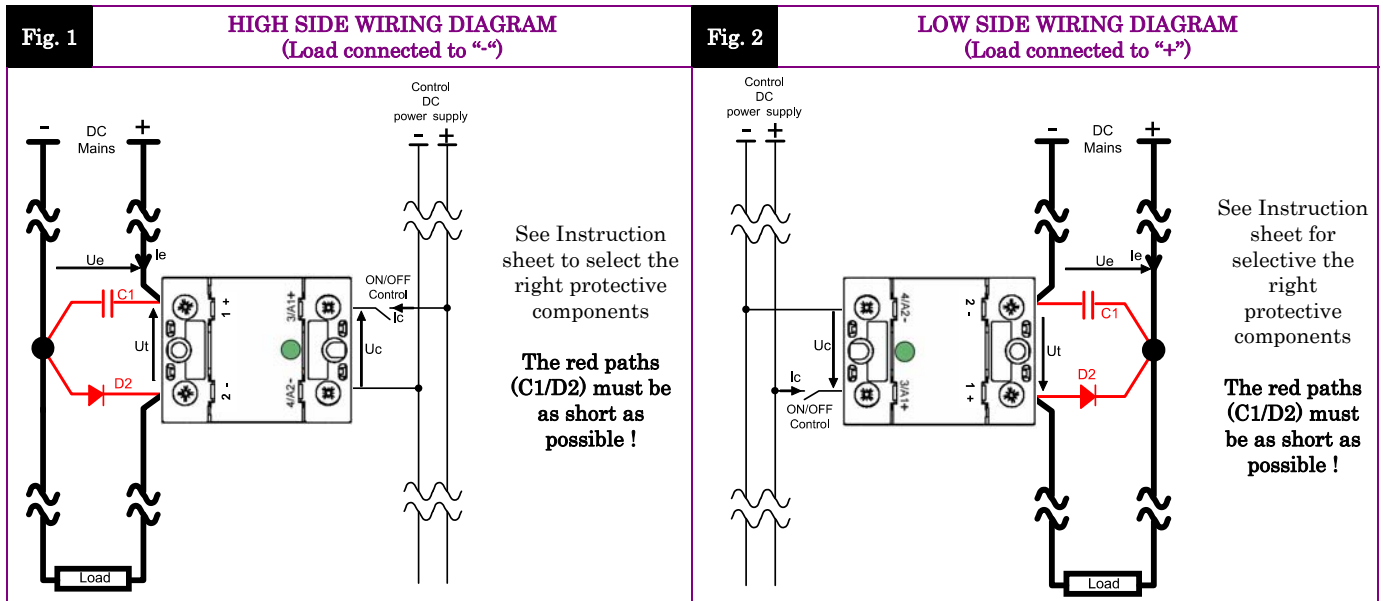

Proud to serve you

CONTROL INPUT CHARACTERISTICS

INPUT CIRCUIT	CHARACTERISTIC	LABEL	VALUE	INFO.
	Nom. Control voltage	Ucnom	12-24VDC	
	Min. Control current	Icmin	35mADC	-100µA/°C
	Control voltage range	Uc	3.5 – 32VDC	typical ON=3.3V
	Control current consumption	Ic	32 – 35mADC (for control voltage range)	See fig. 5
	Releasing control voltage	Ucoffmax	1VDC	typical OFF= 2.6V
	Max. reverse control voltage	-Ucmax	32VDC	-Icmax<100µA
	Input impedance	Rin	Current limitation	See fig. 5

POWER OUTPUT CHARACTERISTICS

POWER CIRCUIT	CHARACTERISTIC	LABEL	VALUE	INFO.	
	Nominal voltage	Uenom	90VDC		
	Voltage range	Ut Ue	5-110VDC		
	Non-repetitive peak voltage	Utp	200V		
	Overvoltage protection	D1	Varistor 75V size 20		
	Max reverse voltage drop (internal diode at OFF state)	-Ut	1.5V	@Ie=-56A @Uc=0	
	Maximum nominal currents	Ie max	Resistive		See fig. 7 (limits)
			40A	Motor Please contact us	
	Non-repetitive peak overload current	Id max	380A		See fig. 8
	Min. load current	Iemin	5mA		
	Max. leakage current	Ielk max	3mA		@Utmax @Tjmax
	Max. on-state resistance	RDson	46mΩ		@Iemax @Tjmax
	Typ. output capacitance	Cout	1.1nF		
	Junction/case thermal resistance per power element	Rthjc	0.7K/W		
	Built-in heatsink thermal resistance vertically mounted	Rthra	10K/W		@ΔTra=75°C
	Heatsink thermal time constant	Tthra	10 minutes		@ΔTra=40°C
	Control inputs/power outputs insulation voltage	Uimp	2.5kV		
	Inputs/case insulation voltage	Uimp	2.5kV		
	Outputs/case insulation voltage	Uimp	2.5kV		
	Isolation resistance	Rio	1GΩ		
	Isolation capacitance	Cio	<8pF		
	Maximum junction temperature	Tjmax	175°C		
	Storage ambient temperature	Tstg	-40->+100°C		
	Operating ambient temperature	Tamb	-25->+90°C		See fig. 7
	Max. case temperature	Tc	100°C		

PROTECTION CHARACTERISTICS

Leakage current (Ielk) vs DC voltage (Ut)

U_{tmax}
(=U_{cmax})

Absolute limits

$U_{to} < U_{tp}$

$$t_{max} = \frac{0.75}{(U_{to} - U_{tmax}) \times I_e}$$

$$P_{(protection)} = 1W_{max}$$

$$\Rightarrow \frac{(U_{to} - U_{tmax}) \times I_e \times t}{T} \leq 1$$

Ielk : Leakage current of the relay
Ie : User load nominal current
Utp : Relay max. non repetitive peak voltage

Utmax : Max. nominal voltage of the relay
Uto : Possible overvoltage above Utmax
Utn = Ue : User DC power supply voltage

t : Overvoltage duration
T : Time between 2 overvoltage

TIME CHARACTERISTICS

Fig. 4

TIME DIAGRAM

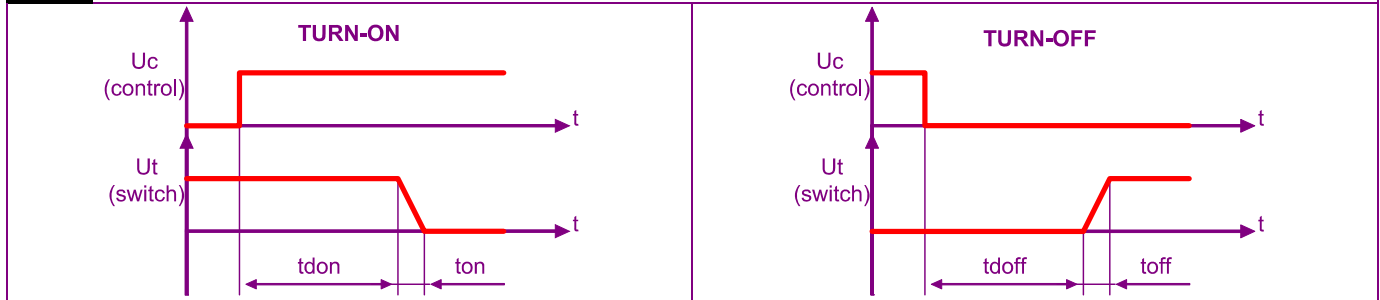

TIME CHARACT.	CHARACTERISTIC	LABEL	VALUE	INFO.
	Turn on time	ton	20µs	
	Turn on delay	tdon	20µs	
	Turn off time	toff	20µs	
	Turn off delay	tdoff	20µs	
Max. On-Off frequency	F_(on-off)	>1000Hz (for high frequency, take 2 x I _e to calculate the heatsink; the protections must be chosen carefully)	Refer to the instruction sheet	

GENERAL INFORMATION

CONNECTIONS	Connections	Power	Control	
	Screwdriver advised	POZIDRIV2		
	Min and max tightening torque	2 N.m	1.2 N.m	
	Insulated crimp terminals (round tabs, eyelet type)	M5	M4	

MISC.	Display	Green LED (indicates relay has switched ON)		
	Housing	UL94V0		
	Mounting	2 screws (M4x12mm ; tightening = 1.2N.m)		See mounting sheet
	Noise level	None		
	Weight	80g		

STANDARDS

GENERAL	Standards	IEC60947-1		
	Protection level	IP20		
	Protection against direct touch	Yes		
	CE marking	Yes		
	UL, cULUS	Yes		

E.M.C. IMMUNITY	TYPE OF TEST	STANDARD	LEVEL	EFFECT
	Fast transients bursts	EN61000-4-4	4kV criterion B	
	Electric chocks	EN61000-4-5	1kV criterion B	
	Voltage drop	EN61000-4-11	-	

CHARACTERISTIC CURVES

Fig. 5

INPUT CHARACTERISTIC

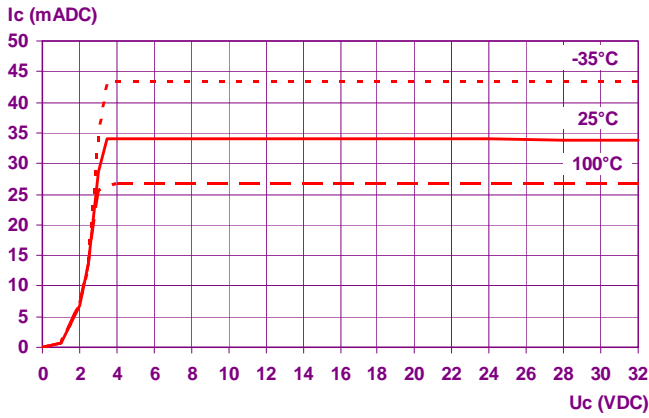

Fig. 6

ON RESISTANCE VS JUNCTION TEMPERATURE

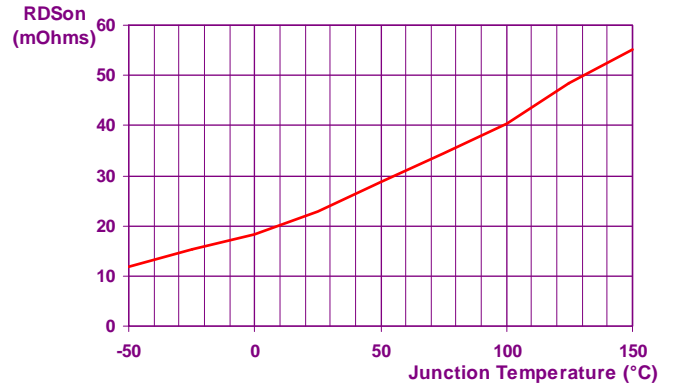

Fig. 7

POWER DISSIPATED AND LOAD CURRENT LIMIT VS TEMPERATURE

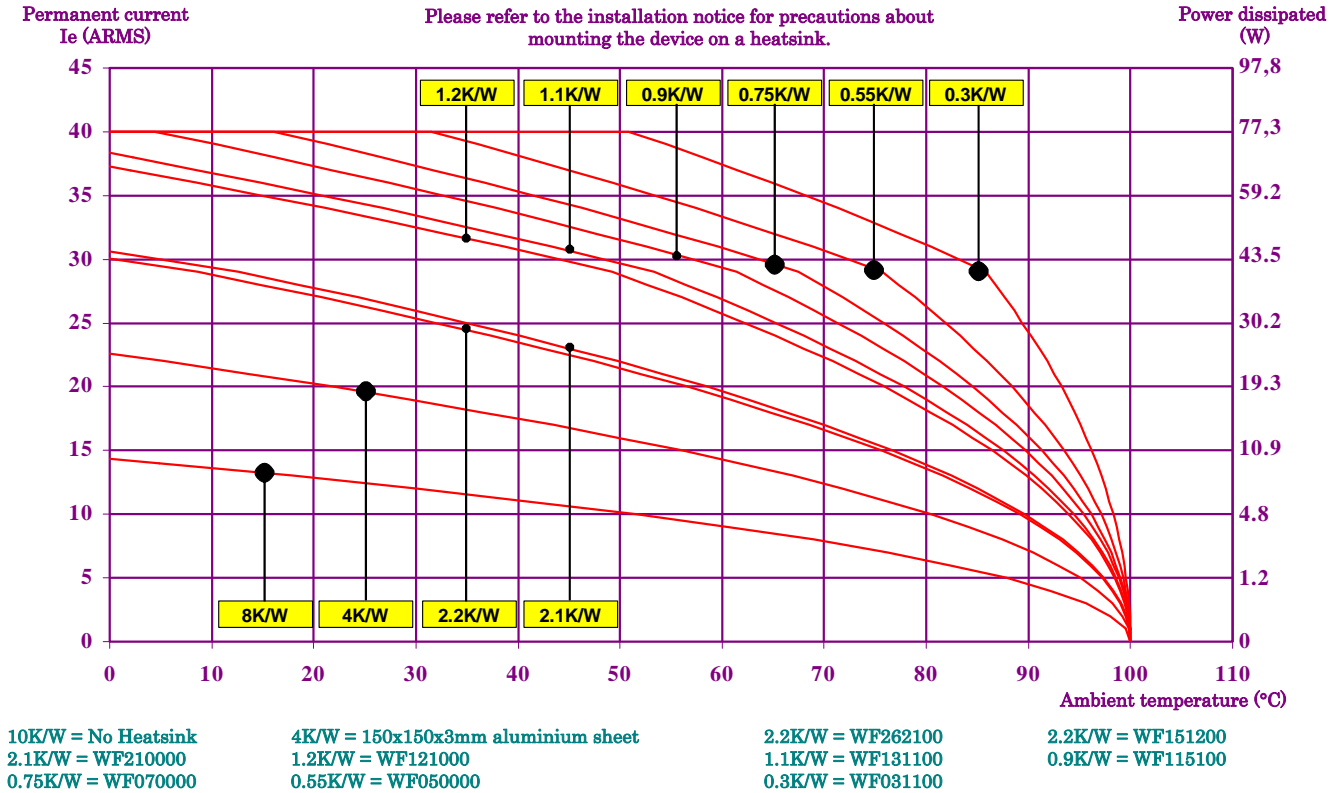
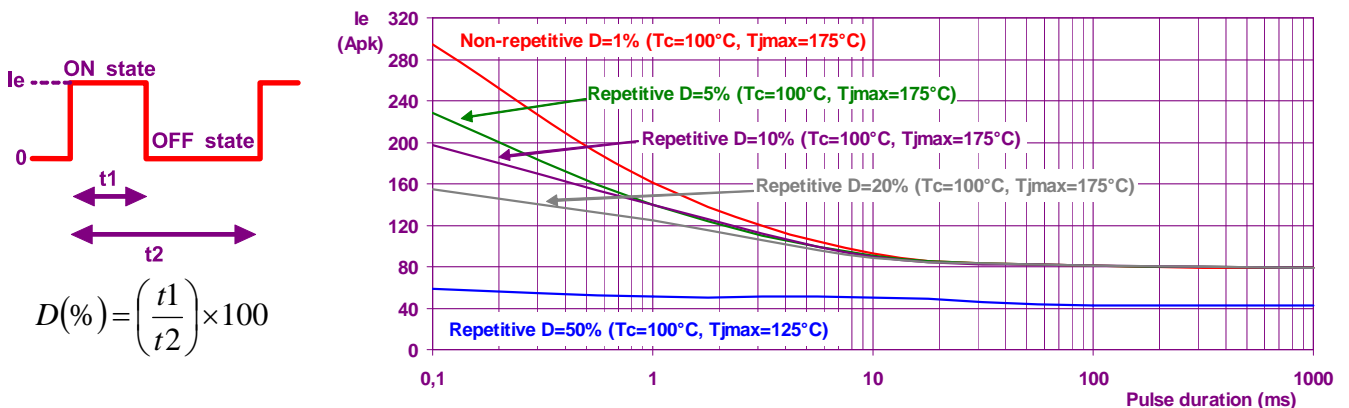

Fig. 8

PEAK OVERLOAD CURRENT vs. PULSE DURATION CHARACTERISTIC



DIMENSIONS AND ACCESSORIES

Fig. 9

DIMENSIONS (mm)

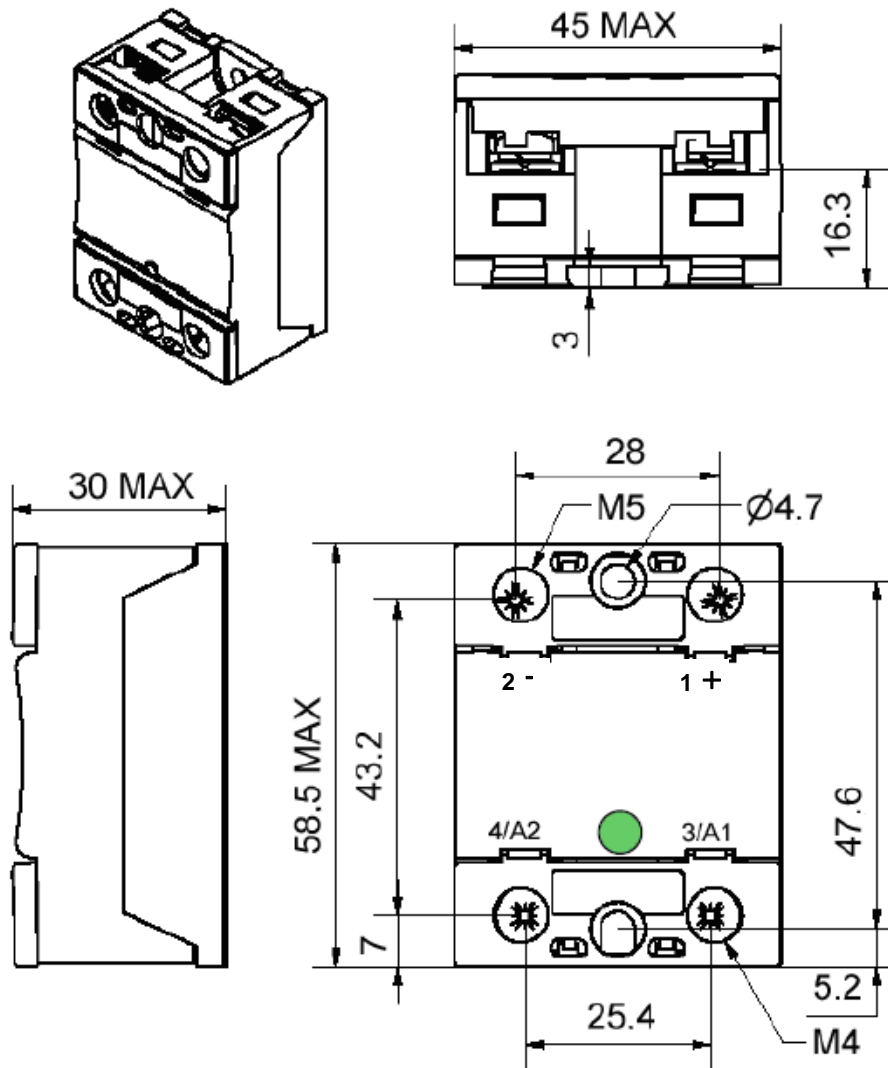

Fig. 10

ACCESSORIES

FASTON : Please contact us

