

MOSFET - Power, Single P-Channel, WDFN8 -30 V, 3.8 mΩ, -96 A

NTTFS008P03P8Z

Features

- Ultra Low $R_{DS(on)}$ to Improve System Efficiency
- Advanced Package Technology in 3.3x3.3mm for Space Saving and Excellent Thermal Conduction
- These Devices are Pb-Free, Halogen Free/BFR Free and are RoHS Compliant

Typical Applications

- Power Load Switch
- Protection: Reverse Current, Over Voltage, and Reverse Negative Voltage
- Battery Management

MAXIMUM RATINGS (T_J = 25°C unless otherwise noted)

Parameter		Symbol	Value	Unit
Drain-to-Source Voltage		V _{DSS}	-30	V
Gate-to-Source Voltage		V _{GS}	±25	V
Continuous Drain Current R _{θJC} (Notes 1, 2)	Steady State	T _C = 25°C	I _D	-96 A
		T _C = 85°C		-69
		T _C = 25°C	P _D	50 W
Continuous Drain Current R _{θJA} (Notes 1, 2)	Steady State	T _A = 25°C	I _D	-22 A
		T _A = 85°C		-16
		T _A = 25°C	P _D	2.67 W
Pulsed Drain Current	T _A = 25°C, t _p = 10 μs	I _{DM}	-418	A
Operating Junction and Storage Temperature Range		T _J , T _{stg}	-55 to 150	°C
Lead Temperature for Soldering Purposes (1/8" from case for 10 s)		T _L	260	°C

Stresses exceeding those listed in the Maximum Ratings table may damage the device. If any of these limits are exceeded, device functionality should not be assumed, damage may occur and reliability may be affected.

THERMAL RESISTANCE MAXIMUM RATINGS

Parameter	Symbol	Value	Unit
Junction-to-Case - Steady State (Drain) (Note 2)	R _{θJC}	2.5	°C/W
Junction-to-Ambient - Steady State (Note 2)	R _{θJA}	47	°C/W

1. The entire application environment impacts the thermal resistance values shown, they are not constants and are only valid for the particular conditions noted.
2. Surface-mounted on FR4 board using a 1 in², 2 oz. Cu pad. Assuming a 76mm x 76mm x 1.6mm board.

V _{(BR)DSS}	R _{DS(on)}	I _D
-30 V	3.8 mΩ @ -10 V	-96 A
	6.5 mΩ @ -4.5 V	

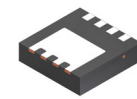
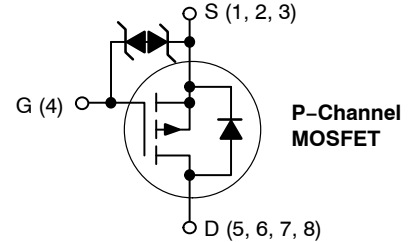

WDFN8
CASE 483AW

MARKING DIAGRAM

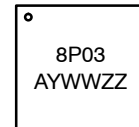

8P03 = Specific Device Code
A = Assembly Location
Y = Year
WW = Work Week
ZZ = Lot Traceability Code

ORDERING INFORMATION

Device	Package	Shipping [†]
NTTFS008P03P8Z	WDFN8 (Pb-Free)	3000 / Tape & Reel

[†]For information on tape and reel specifications, including part orientation and tape sizes, please refer to our Tape and Reel Packaging Specification Brochure, BRD8011/D.

NTTFS008P03P8Z

ELECTRICAL CHARACTERISTICS (T_J = 25°C unless otherwise noted)

Parameter	Symbol	Test Condition	Min	Typ	Max	Unit
OFF CHARACTERISTICS						
Drain-to-Source Breakdown Voltage	V _{(BR)DSS}	V _{GS} = 0 V, I _D = -250 μA	-30			V
Drain-to-Source Breakdown Voltage Temperature Coefficient	V _{(BR)DSS} /T _J	I _D = -250 μA, ref to 25°C		-8		mV/°C
Zero Gate Voltage Drain Current	I _{DSS}	V _{GS} = 0 V, V _{DS} = -24 V, T _J = 25°C			-1.0	μA
Gate-to-Source Leakage Current	I _{GSS}	V _{DS} = 0 V, V _{GS} = ± 25 V			± 10	μA

ON CHARACTERISTICS (Note 3)

Gate Threshold Voltage	V _{GS(TH)}	V _{GS} = V _{DS} , I _D = -250 μA	-1.0		-3.0	V
Threshold Temperature Coefficient	V _{GS(TH)} /T _J	I _D = -250 μA, ref to 25°C		5.9		mV/°C
Drain-to-Source On Resistance	R _{DS(on)}	V _{GS} = -10 V, I _D = -18 A		2.5	3.8	mΩ
		V _{GS} = -4.5 V, I _D = -14 A		4.3	6.5	
Forward Transconductance	g _{FS}	V _{DS} = -5 V, I _D = -14 A		74		S

CHARGES AND CAPACITANCES

Input Capacitance	C _{iss}	V _{GS} = 0 V, f = 1.0 MHz, V _{DS} = -15 V		5600		pF
Output Capacitance	C _{oss}			1940		
Reverse Transfer Capacitance	C _{rss}			1890		
Total Gate Charge	Q _{G(TOT)}	V _{GS} = -10 V, V _{DS} = -15 V, I _D = -14 A		134		nC
Threshold Gate Charge	Q _{G(TH)}			3		
Gate-to-Source Charge	Q _{GS}			15		
Gate-to-Drain Charge	Q _{GD}			51		
Total Gate Charge	Q _{G(TOT)}	V _{GS} = -4.5 V, V _{DS} = -15 V, I _D = -14 A		82		

SWITCHING CHARACTERISTICS, V_{GS} = 4.5 V (Note 3)

Turn-On Delay Time	t _{d(on)}	V _{GS} = -4.5 V, V _{DS} = -15 V, I _D = -14 A, R _G = 6 Ω		49		ns
Rise Time	t _r			248		
Turn-Off Delay Time	t _{d(off)}			95		
Fall Time	t _f			187		

SWITCHING CHARACTERISTICS, V_{GS} = 10 V (Note 3)

Turn-On Delay Time	t _{d(on)}	V _{GS} = -10 V, V _{DS} = -15 V, I _D = -14 A, R _G = 6 Ω		19		ns
Rise Time	t _r			53		
Turn-Off Delay Time	t _{d(off)}			201		
Fall Time	t _f			177		

DRAIN-SOURCE DIODE CHARACTERISTICS

Forward Diode Voltage	V _{SD}	V _{GS} = 0 V, I _S = -14 A	T _J = 25°C	-0.77	-1.3	V
			T _J = 125°C	-0.63		
Reverse Recovery Time	t _{RR}	V _{GS} = 0 V, dI _S /dt = 100 A/μs, I _S = -14 A		52		ns
Charge Time	t _a			21		
Discharge Time	t _b			30		
Reverse Recovery Charge	Q _{RR}			31		

Product parametric performance is indicated in the Electrical Characteristics for the listed test conditions, unless otherwise noted. Product performance may not be indicated by the Electrical Characteristics if operated under different conditions.

3. Pulse Test: Pulse Width ≤ 300 μs, Duty Cycle ≤ 2%.

TYPICAL CHARACTERISTICS

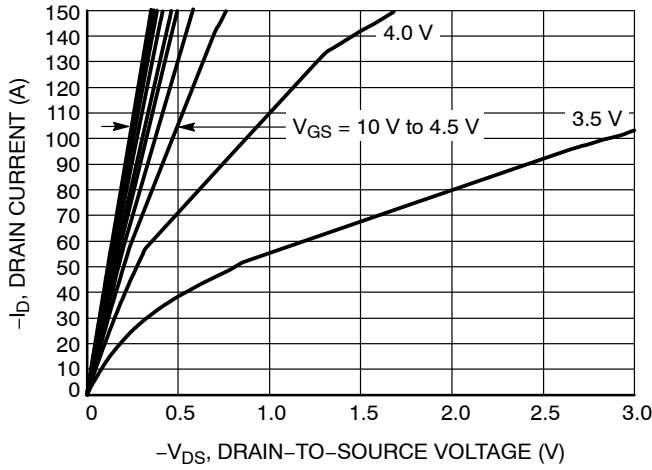

Figure 1. On-Region Characteristics

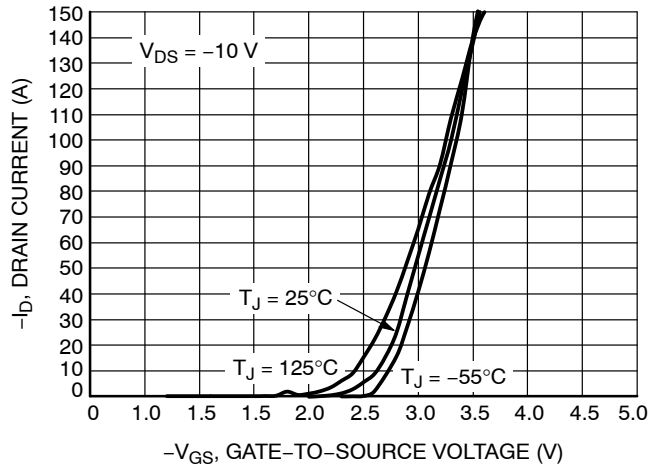

Figure 2. Transfer Characteristics

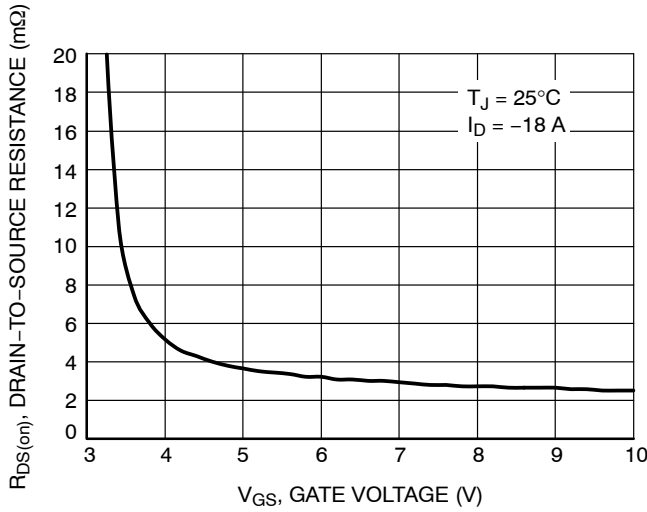

Figure 3. On-Resistance vs. Gate-to-Source Voltage

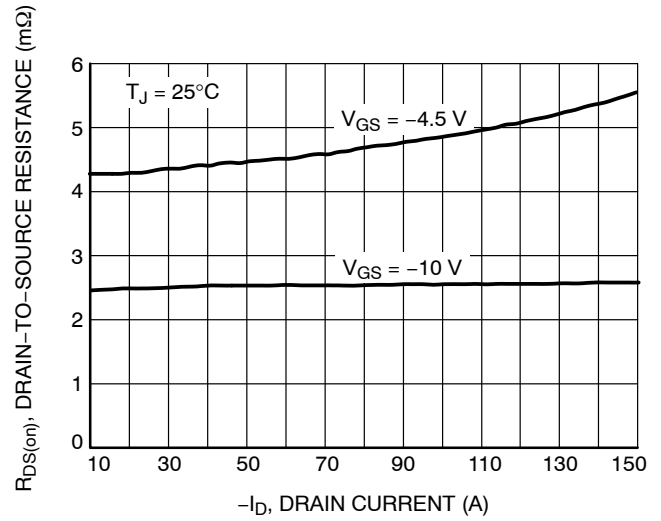

Figure 4. On-Resistance vs. Drain Current and Gate Voltage

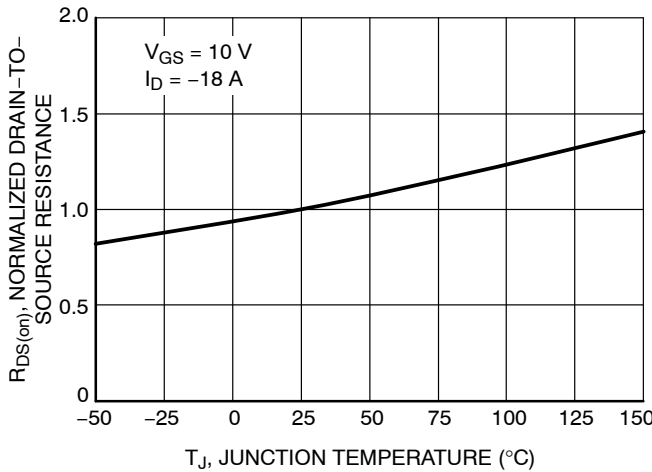

Figure 5. On-Resistance Variation with Temperature

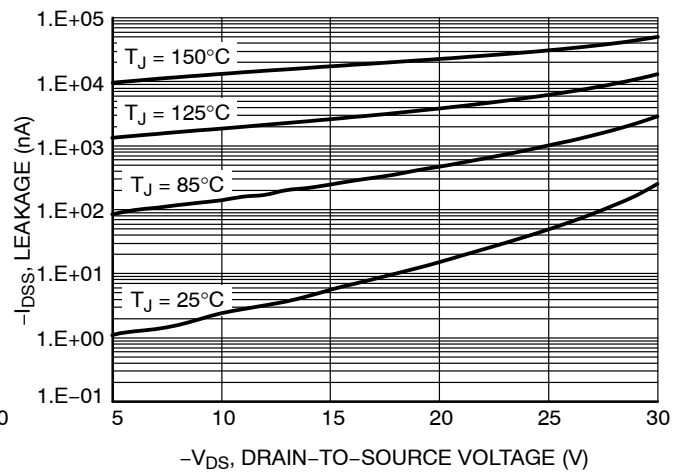

Figure 6. Drain-to-Source Leakage Current vs. Voltage

TYPICAL CHARACTERISTICS

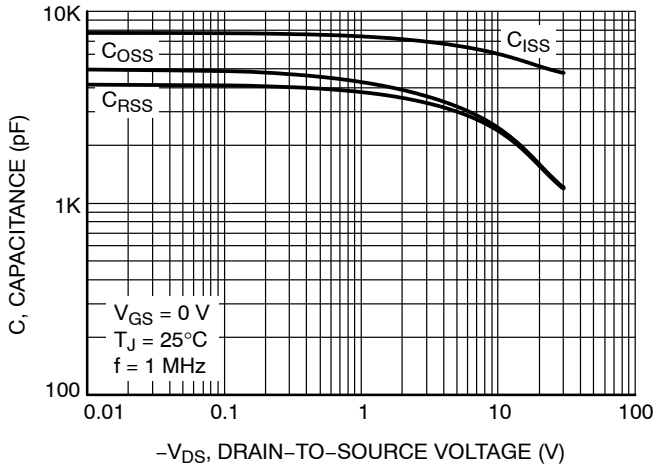

Figure 7. Capacitance Variation

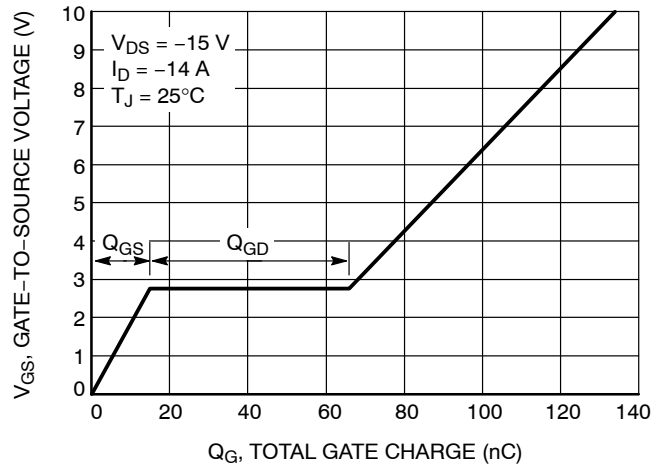

Figure 8. Gate-to-Source and Drain-to-Source Voltage vs. Total Charge

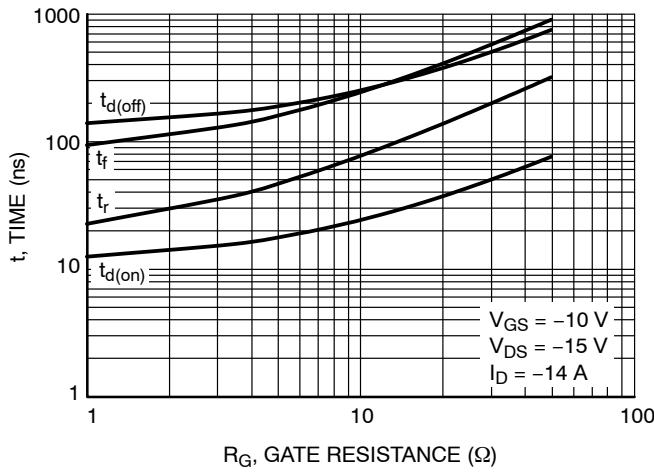

Figure 9. Resistive Switching Time Variation vs. Gate Resistance

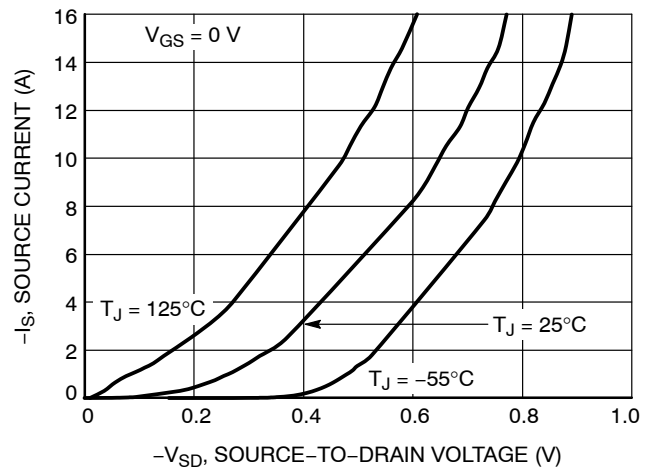

Figure 10. Diode Forward Voltage vs. Current

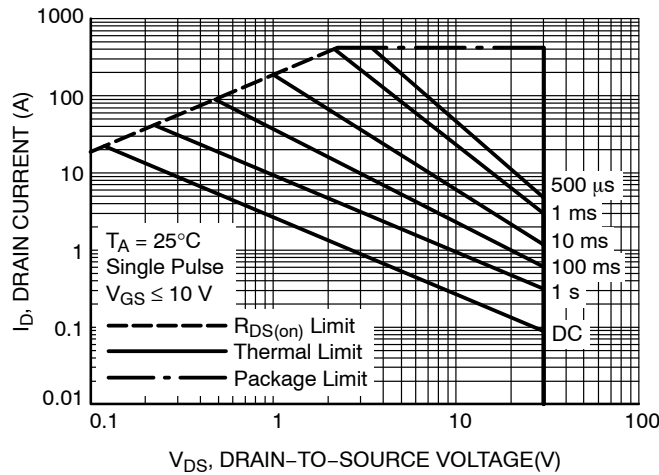

Figure 11. Safe Operating Area

NTTFS008P03P8Z

TYPICAL CHARACTERISTICS

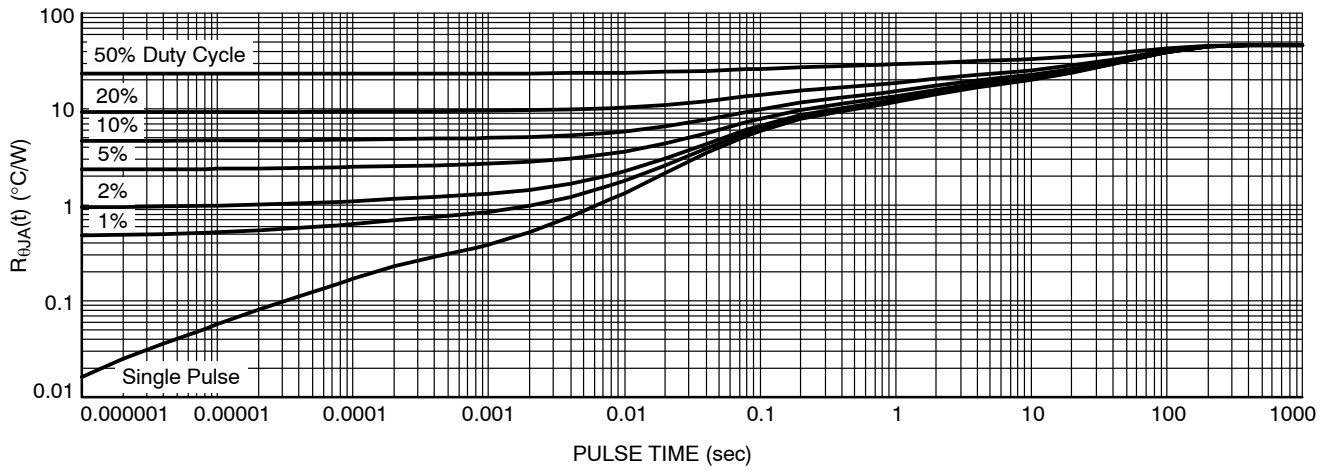
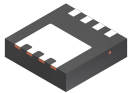

Figure 12. Thermal Characteristics

MECHANICAL CASE OUTLINE

PACKAGE DIMENSIONS

ON Semiconductor®



WDFN8 3.3X3.3, 0.65P
CASE 483AW
ISSUE A

DATE 10 SEP 2019

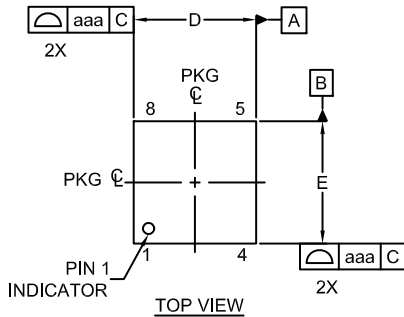

TOP VIEW

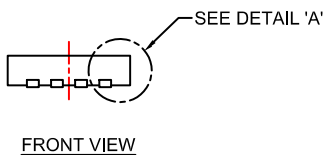

FRONT VIEW

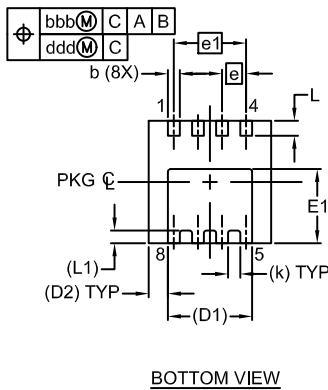

BOTTOM VIEW

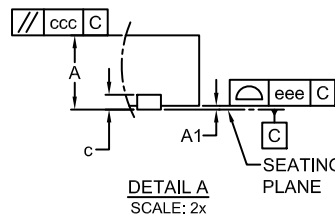

DETAIL A
SCALE: 2x

LAND PATTERN RECOMMENDATION*

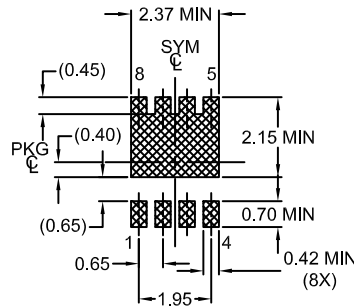

NOTES:

1. CONTROLLING DIMENSION: MILLIMETERS.
2. COPLANARITY APPLIES TO THE EXPOSED PADS AS WELL AS THE TERMINALS.
3. DIMENSIONS D AND E DO NOT INCLUDE MOLD FLASH, PROTRUSIONS OR GATE BURRS.
4. SEATING PLANE IS DEFINED BY THE TERMINALS. 'A1' IS DEFINED AS THE DISTANCE FROM THE SEATING PLANE TO THE LOWEST POINT ON THE PACKAGE BODY.

DIM	MILLIMETERS		
	MIN	NOM	MAX
A	0.70	0.75	0.80
A1	-	-	0.05
b	0.27	0.32	0.37
c	0.15	0.20	0.25
D	3.20	3.30	3.40
D1	2.27 REF		
D2	0.52 REF		
E	3.20	3.30	3.40
E1	1.85	1.95	2.05
e	0.65 BSC		
e1	1.95 BSC		
k	0.33 REF		
L	0.30	0.40	0.50
L1	0.34 REF		
aaa	0.10		
bbb	0.10		
ccc	0.10		
ddd	0.05		
eee	0.05		

*FOR ADDITIONAL INFORMATION ON OUR PB-FREE STRATEGY AND SOLDERING DETAILS, PLEASE DOWNLOAD THE ON SEMICONDUCTOR SOLDERING AND MOUNTING TECHNIQUES REFERENCE MANUAL, SOLDERRM/D.

GENERIC MARKING DIAGRAM*



XXXX = Specific Device Code
 A = Assembly Location
 Y = Year
 WW = Work Week

*This information is generic. Please refer to device data sheet for actual part marking. Pb-Free indicator, "G" or microdot "•", may or may not be present. Some products may not follow the Generic Marking.

DOCUMENT NUMBER:	98AON13672G	Electronic versions are uncontrolled except when accessed directly from the Document Repository. Printed versions are uncontrolled except when stamped "CONTROLLED COPY" in red.
DESCRIPTION:	WDFN8 3.3X3.3, 0.65P	PAGE 1 OF 1

ON Semiconductor and are trademarks of Semiconductor Components Industries, LLC dba ON Semiconductor or its subsidiaries in the United States and/or other countries. ON Semiconductor reserves the right to make changes without further notice to any products herein. ON Semiconductor makes no warranty, representation or guarantee regarding the suitability of its products for any particular purpose, nor does ON Semiconductor assume any liability arising out of the application or use of any product or circuit, and specifically disclaims any and all liability, including without limitation special, consequential or incidental damages. ON Semiconductor does not convey any license under its patent rights nor the rights of others.

onsemi, **Onsemi**, and other names, marks, and brands are registered and/or common law trademarks of Semiconductor Components Industries, LLC dba "**onsemi**" or its affiliates and/or subsidiaries in the United States and/or other countries. **onsemi** owns the rights to a number of patents, trademarks, copyrights, trade secrets, and other intellectual property. A listing of **onsemi**'s product/patent coverage may be accessed at www.onsemi.com/site/pdf/Patent-Marking.pdf. **onsemi** reserves the right to make changes at any time to any products or information herein, without notice. The information herein is provided "as-is" and **onsemi** makes no warranty, representation or guarantee regarding the accuracy of the information, product features, availability, functionality, or suitability of its products for any particular purpose, nor does **onsemi** assume any liability arising out of the application or use of any product or circuit, and specifically disclaims any and all liability, including without limitation special, consequential or incidental damages. Buyer is responsible for its products and applications using **onsemi** products, including compliance with all laws, regulations and safety requirements or standards, regardless of any support or applications information provided by **onsemi**. "Typical" parameters which may be provided in **onsemi** data sheets and/or specifications can and do vary in different applications and actual performance may vary over time. All operating parameters, including "Typicals" must be validated for each customer application by customer's technical experts. **onsemi** does not convey any license under any of its intellectual property rights nor the rights of others. **onsemi** products are not designed, intended, or authorized for use as a critical component in life support systems or any FDA Class 3 medical devices or medical devices with a same or similar classification in a foreign jurisdiction or any devices intended for implantation in the human body. Should Buyer purchase or use **onsemi** products for any such unintended or unauthorized application, Buyer shall indemnify and hold **onsemi** and its officers, employees, subsidiaries, affiliates, and distributors harmless against all claims, costs, damages, and expenses, and reasonable attorney fees arising out of, directly or indirectly, any claim of personal injury or death associated with such unintended or unauthorized use, even if such claim alleges that **onsemi** was negligent regarding the design or manufacture of the part. **onsemi** is an Equal Opportunity/Affirmative Action Employer. This literature is subject to all applicable copyright laws and is not for resale in any manner.

ADDITIONAL INFORMATION

TECHNICAL PUBLICATIONS:

Technical Library: www.onsemi.com/design/resources/technical-documentation
onsemi Website: www.onsemi.com

ONLINE SUPPORT: www.onsemi.com/support

For additional information, please contact your local Sales Representative at www.onsemi.com/support/sales