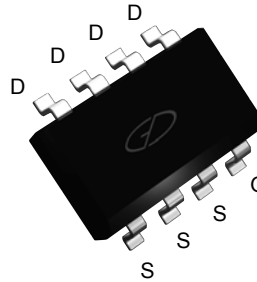
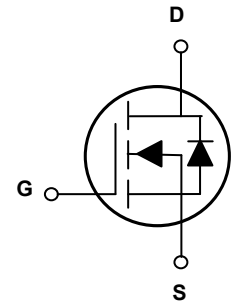


### Main Product Characteristics

$V_{DS}$	30V
$R_{DS(ON)}$	12m $\Omega$
$I_D$	10A



SOP-8



Schematic Diagram

### Features and Benefits

- Advanced MOSFET process technology
- Ideal for high efficiency switched mode power supplies
- Low on-resistance with low gate charge
- Fast switching and reverse body recovery



### Description

The SSFQ3910 utilizes the latest techniques to achieve high cell density and low on-resistance. These features make this device extremely efficient and reliable for use in high efficiency switch mode power supply and a wide variety of other applications.

### Absolute Maximum Ratings (T<sub>c</sub>=25°C unless otherwise specified)

Parameter	Symbol	Rating	Unit
Drain-Source Voltage	$V_{DS}$	30	V
Gate-Source Voltage	$V_{GS}$	$\pm 20$	V
Drain Current – Continuous (T <sub>c</sub> =25°C)	$I_D$	10	A
Drain Current – Continuous (T <sub>c</sub> =100°C)		6.3	A
Drain Current – Pulsed <sup>1</sup>	$I_{DM}$	40	A
Single Pulse Avalanche Energy <sup>2</sup>	$E_{AS}$	13	mJ
Single Pulse Avalanche Current <sup>2</sup>	$I_{AS}$	16	A
Power Dissipation (T <sub>c</sub> =25°C)	$P_D$	2.1	W
Power Dissipation – Derate above 25°C		0.017	W/°C
Storage Temperature Range	$T_{STG}$	-55 to +150	°C
Operating Junction Temperature Range	$T_J$	-55 to +150	°C

### Thermal Characteristics

Parameter	Symbol	Typ.	Max.	Unit
Thermal Resistance Junction to Ambient	$R_{\theta JA}$	---	60	°C/W

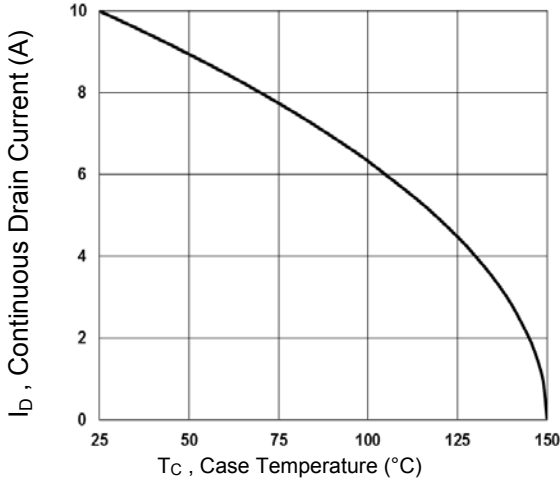
**Electrical Characteristics** ( $T_J=25^\circ\text{C}$  unless otherwise specified)

Parameter	Symbol	Conditions	Min.	Typ.	Max.	Unit
<b>Off Characteristics</b>						
Drain-Source Breakdown Voltage	$BV_{DSS}$	$V_{GS}=0V, I_b=250\mu A$	30	---	---	V
$BV_{DSS}$ Temperature Coefficient	$\Delta BV_{DSS}/\Delta T_J$	Reference to $25^\circ\text{C}, I_b=1\text{mA}$	---	0.04	---	$V/^\circ\text{C}$
Drain-Source Leakage Current	$I_{DSS}$	$V_{DS}=30V, V_{GS}=0V, T_J=25^\circ\text{C}$	---	---	1	$\mu A$
		$V_{DS}=30V, V_{GS}=0V, T_J=125^\circ\text{C}$	---	---	10	$\mu A$
Gate-Source Leakage Current	$I_{GSS}$	$V_{GS}=\pm 20V, V_{DS}=0V$	---	---	$\pm 100$	nA
<b>On Characteristics</b>						
Static Drain-Source On-Resistance	$R_{DS(ON)}$	$V_{GS}=10V, I_b=10A$	---	9.5	12	m $\Omega$
		$V_{GS}=4.5V, I_b=5A$	---	13	18	m $\Omega$
Gate Threshold Voltage	$V_{GS(th)}$	$V_{GS}=V_{DS}, I_D=250\mu A$	1.2	1.8	2.5	V
$V_{GS(th)}$ Temperature Coefficient	$\Delta V_{GS(th)}$		---	-4	---	$\text{mV}/^\circ\text{C}$
Forward Transconductance	$g_{fs}$	$V_{DS}=10V, I_b=3A$	---	6	---	S
<b>Dynamic and Switching Characteristics</b>						
Total Gate Charge <sup>3,4</sup>	$Q_g$	$V_{DS}=15V, V_{GS}=4.5V, I_b=5A$	---	7.4	12	nC
Gate-Source Charge <sup>3,4</sup>	$Q_{gs}$		---	2.3	5	
Gate-Drain Charge <sup>3,4</sup>	$Q_{gd}$		---	3	6	
Turn-On Delay Time <sup>3,4</sup>	$T_{d(on)}$	$V_{DD}=15V, V_{GS}=10V, R_G=6\Omega, I_b=1A$	---	3.8	7	nS
Rise Time <sup>3,4</sup>	$T_r$		---	10	19	
Turn-Off Delay Time <sup>3,4</sup>	$T_{d(off)}$		---	22	42	
Fall Time <sup>3,4</sup>	$T_f$		---	6.6	13	
Input Capacitance	$C_{iss}$	$V_{DS}=25V, V_{GS}=0V, F=1\text{MHz}$	---	620	900	pF
Output Capacitance	$C_{oss}$		---	85	125	
Reverse Transfer Capacitance	$C_{rss}$		---	60	90	
Gate Resistance	$R_g$	$V_{GS}=0V, V_{DS}=0V, F=1\text{MHz}$	---	2.8	5.6	$\Omega$
<b>Drain-Source Diode Characteristics and Maximum Ratings</b>						
Parameter	Symbol	Conditions	Min.	Typ.	Max.	Unit
Continuous Source Current	$I_S$	$V_G=V_D=0V, \text{Force Current}$	---	---	10	A
Pulsed Source Current	$I_{SM}$		---	---	40	A
Diode Forward Voltage	$V_{SD}$	$V_{GS}=0V, I_S=1A, T_J=25^\circ\text{C}$	---	---	1	V

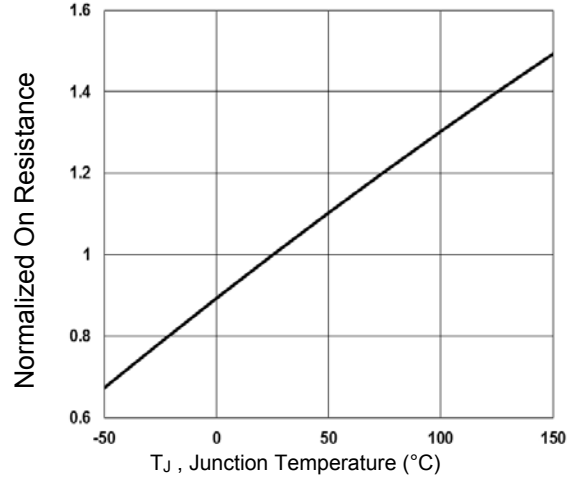
Note:

1. Repetitive Rating: Pulsed width limited by maximum junction temperature.
2.  $V_{DD}=25V, V_{GS}=10V, L=0.1\text{mH}, I_{AS}=16A, R_G=25\Omega, \text{Starting } T_J=25^\circ\text{C}$ .
3. The data tested by pulsed, pulse width  $\leq 300\mu\text{s}$ , duty cycle  $\leq 2\%$ .
4. Essentially independent of operating temperature.

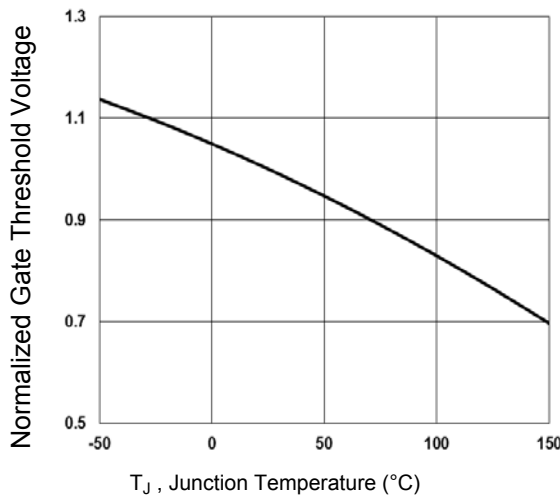
**Typical Electrical and Thermal Characteristic Curves**



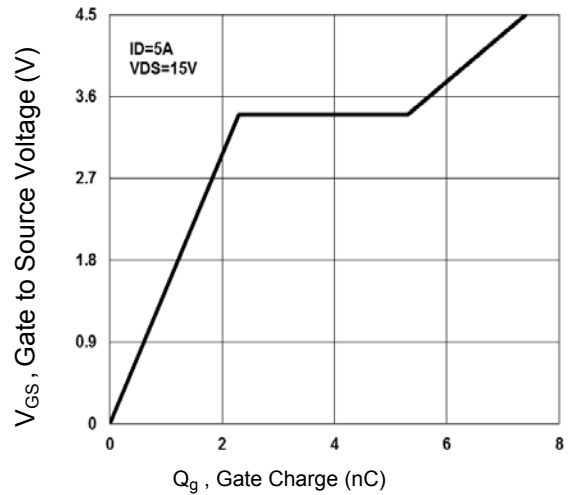
**Fig.1 Continuous Drain Current vs. Tc**



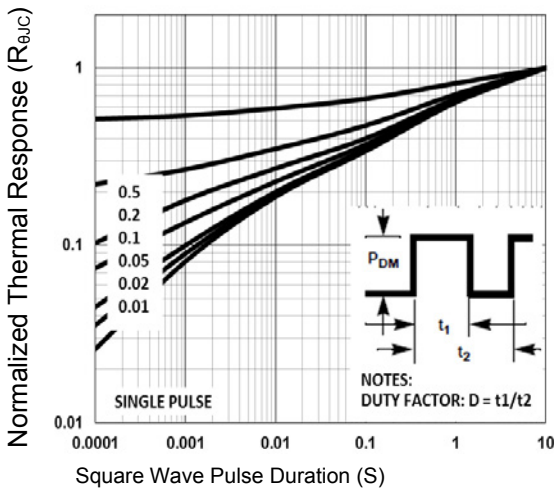
**Fig.2 Normalized  $R_{DS(ON)}$  vs.  $T_J$**



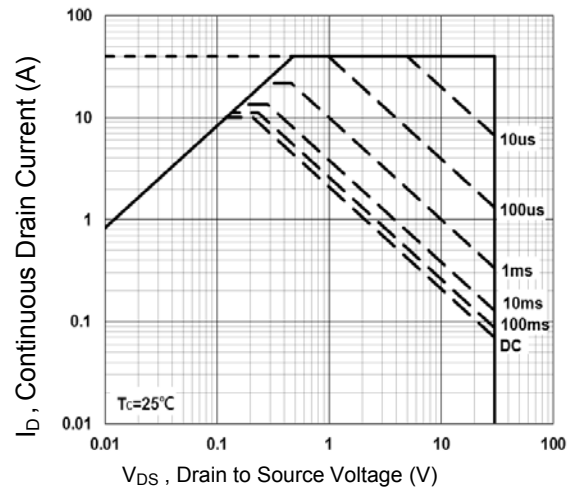
**Fig.3 Normalized  $V_{th}$  vs.  $T_J$**



**Fig.4 Gate Charge Waveform**

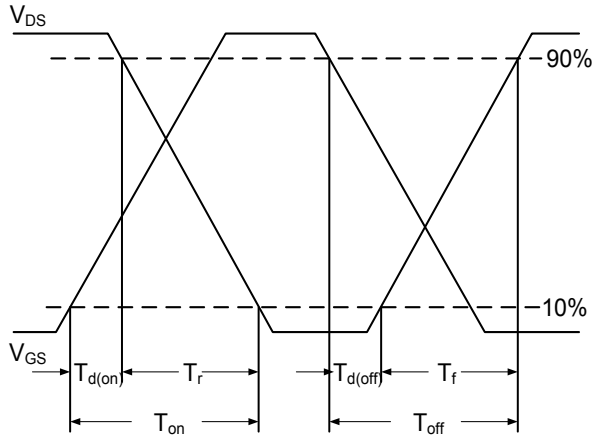


**Fig.5 Normalized Transient Impedance**

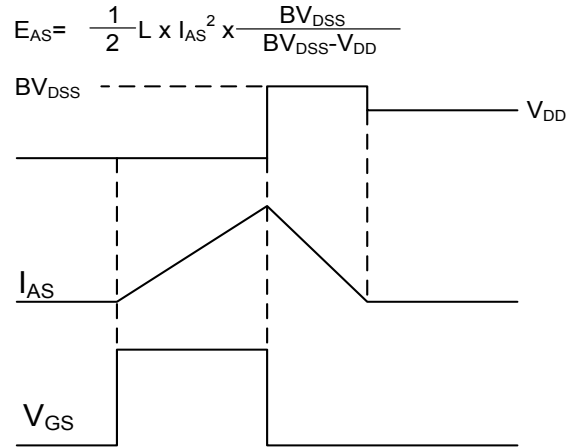


**Fig.6 Maximum Safe Operation Area**

**Typical Electrical and Thermal Characteristic Curves**



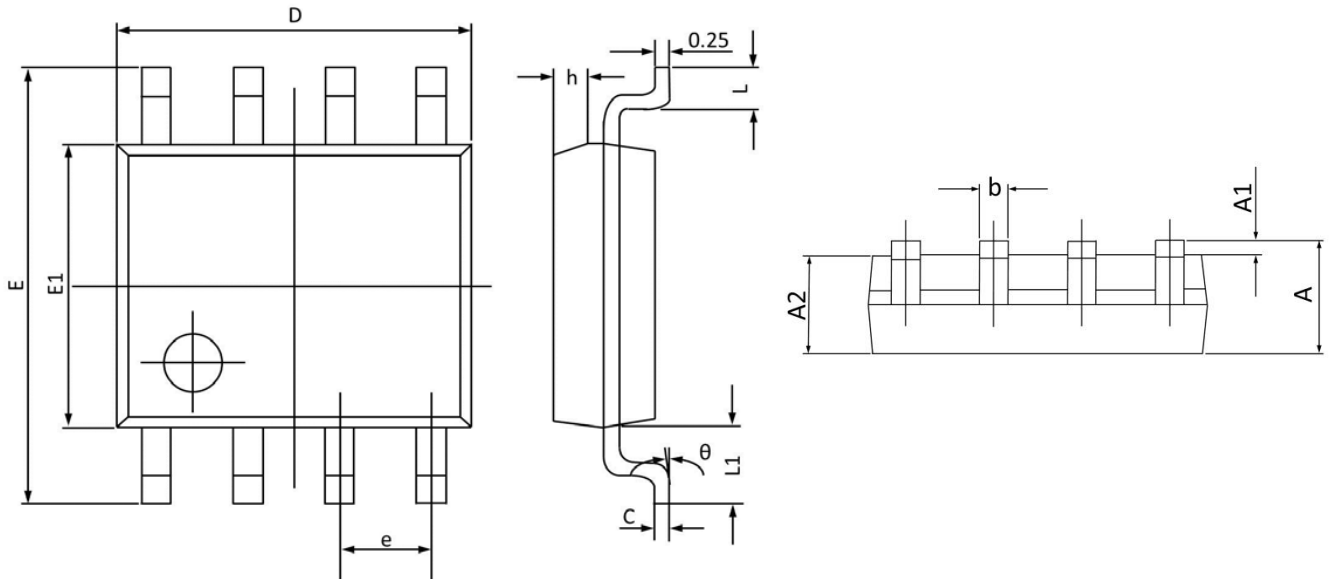
**Fig.7 Switching Time Waveform**



**Fig.8  $E_{AS}$  Waveform**

### Package Outline Dimensions

### SOP-8



Symbol	Dimensions In Millimeters		Dimensions In Inches	
	Min	Max	Min	Max
A	1.350	1.750	0.053	0.068
A1	0.100	0.250	0.004	0.009
A2	1.300	1.500	0.052	0.059
A3	0.600	0.700	0.024	0.027
b	0.390	0.480	0.016	0.018
c	0.210	0.260	0.009	0.010
D	4.700	5.100	0.186	0.200
E	5.800	6.200	0.229	0.244
E1	3.700	4.100	0.146	0.161
e	1.270(BSC)		0.050(BSC)	
h	0.250	0.500	0.010	0.019
L	0.500	0.800	0.019	0.031
L1	1.050(BSC)		0.041(BSC)	
θ	0°	8°	0°	8°

### Order Information

Device	Package	Marking Code	Carrier	Quantity	HSF Status
SSFQ3910	SOP-8	DS3910	Tape & Reel	3,000/Reel	RoHS Compliant