

## OLGA-O

~20° + 40° oval beam. Assembly with holder and installation tape.

### TECHNICAL SPECIFICATIONS:

Dimensions	Ø 32.0 mm
Height	19.1 mm
Fastening	tape, pin
ROHS compliant	yes ⓘ

### MATERIAL SPECIFICATIONS:

Component	Type	Material	Colour	Finish
OLGA-O	Single lens	PMMA	clear	
OLGA-HLD	Holder	PC	black	
SPUTNIK-TAPE3	Tape	PU tape	black	

### ORDERING INFORMATION:

Component	Type	Qty in box	MOQ	MPQ	Box weight (kg)
CA16674_OLGA-O	Single lens	792	132	66	9.8
» Box size: 476 x 273 x 292 mm					



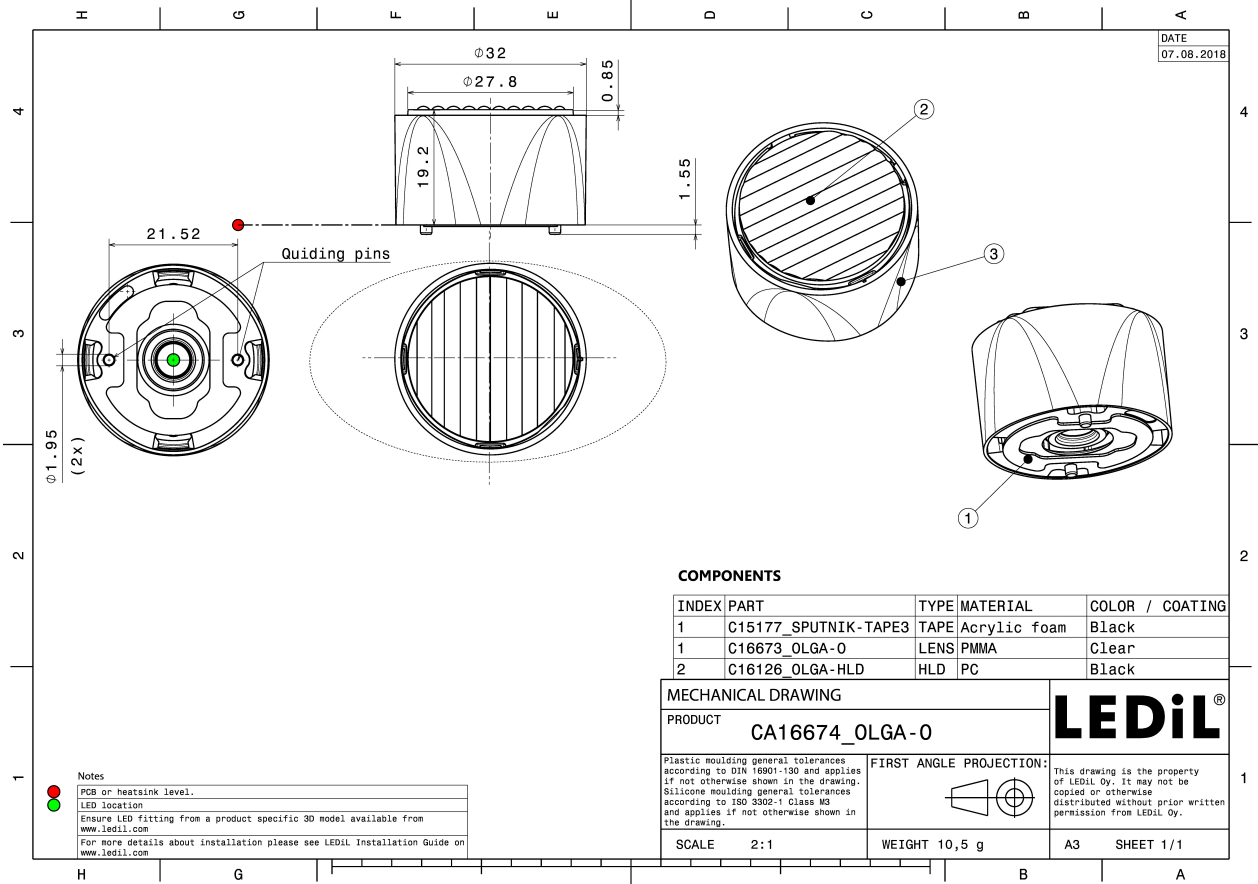

See also our general installation guide: [www.ledil.com/installation\\_guide](http://www.ledil.com/installation_guide)

#### PHOTOMETRIC DATA (MEASURED):

**CREE** 

LED XHP50.2  
 FWHM / FWTM 42.0 + 21.0° / 72.0 + 47.0°  
 Efficiency 79 %  
 Peak intensity 2.3 cd/lm  
 LEDs/each optic 1  
 Light colour White  
 Required components:

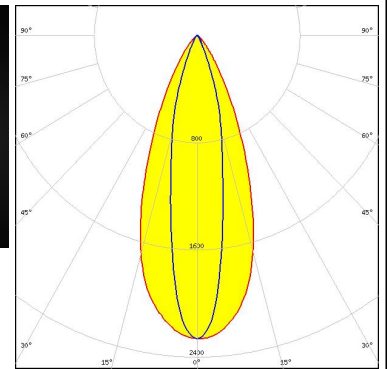

**CREE** 

LED XM-L3  
 FWHM / FWTM 43.0 + 15.0° / 65.0 + 34.0°  
 Efficiency 86 %  
 Peak intensity 3.5 cd/lm  
 LEDs/each optic 1  
 Light colour White  
 Required components:

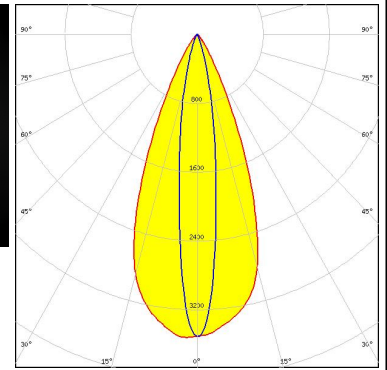

**CREE** 

LED XP-E2  
 FWHM / FWTM 44.0 + 10.0° / 60.0 + 23.0°  
 Efficiency 88 %  
 Peak intensity 5.4 cd/lm  
 LEDs/each optic 1  
 Light colour White  
 Required components:

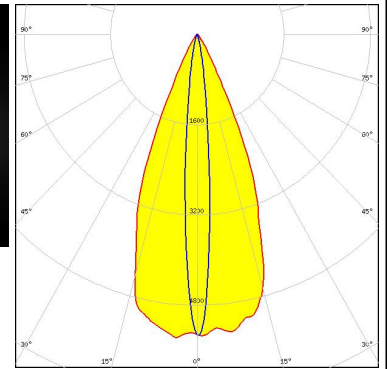

**CREE** 

LED XQ-E HD  
 FWHM / FWTM 44.0 + 11.0° / 62.0 + 26.0°  
 Efficiency 80 %  
 Peak intensity 4.2 cd/lm  
 LEDs/each optic 1  
 Light colour White  
 Required components:

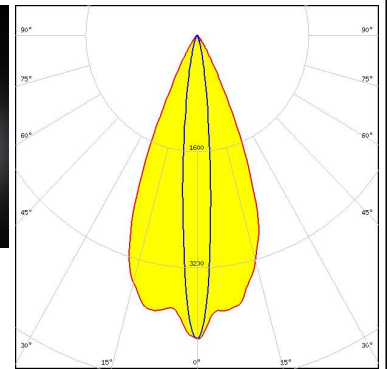

#### PHOTOMETRIC DATA (MEASURED):



LED XQ-E HI  
 FWHM / FWTM 44.0 + 10.0° / 60.0 + 25.0°  
 Efficiency 85 %  
 Peak intensity 4.7 cd/lm  
 LEDs/each optic 1  
 Light colour White  
 Required components:

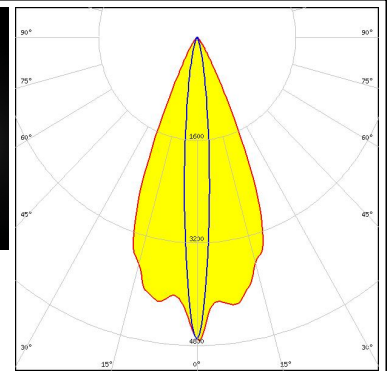

LED XT-E  
 FWHM / FWTM 44.0 + 13.0° / 65.0 + 30.0°  
 Efficiency 84 %  
 Peak intensity 3.8 cd/lm  
 LEDs/each optic 1  
 Light colour White  
 Required components:

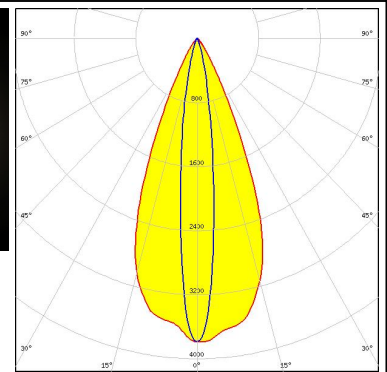

LED LUXEON MZ  
 FWHM / FWTM 43.0 + 18.0° / 67.0 + 39.0°  
 Efficiency 86 %  
 Peak intensity 3 cd/lm  
 LEDs/each optic 1  
 Light colour White  
 Required components:

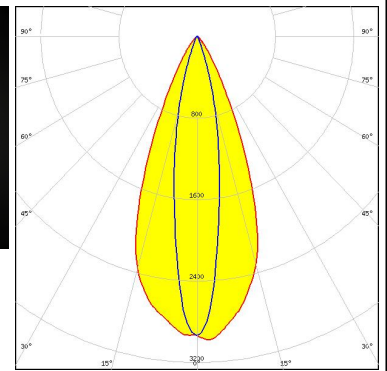
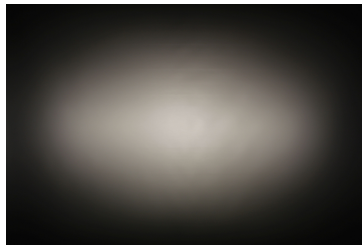



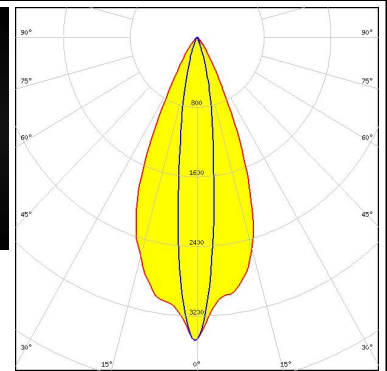
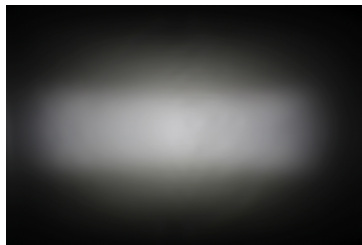



LED NCSxE17A  
 FWHM / FWTM 43.0 + 14.0° / 65.0 + 34.0°  
 Efficiency 84 %  
 Peak intensity 3.5 cd/lm  
 LEDs/each optic 1  
 Light colour White  
 Required components:

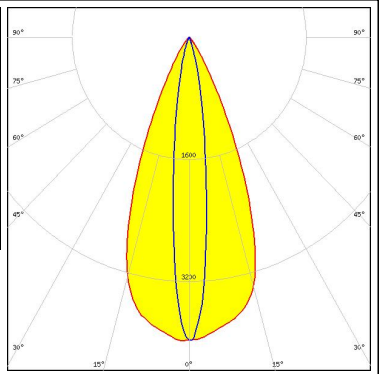

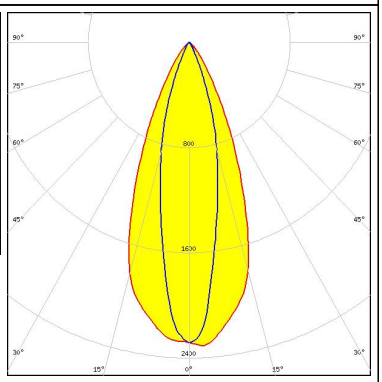

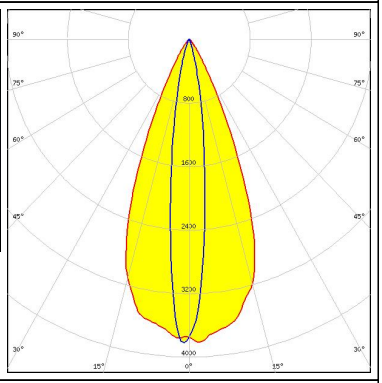
### PHOTOMETRIC DATA (MEASURED):

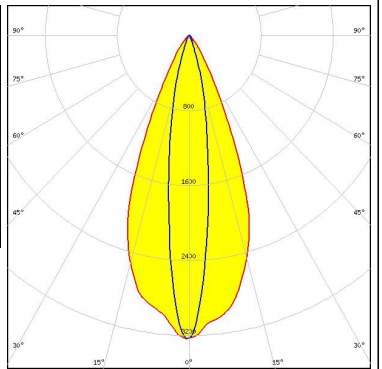
<p><b>NICHIA</b></p> <p>LED NVSW319B            FWHM / FWTM 44.0 + 13.0° / 64.0 + 30.0°            Efficiency 88 %            Peak intensity 4 cd/lm            LEDs/each optic 1            Light colour White            Required components:</p>		
<p><b>OSRAM</b> Opto Semiconductors</p> <p>LED Duris S8            FWHM / FWTM 43.0 + 23.0° / 72.0 + 49.0°            Efficiency 85 %            Peak intensity 2.3 cd/lm            LEDs/each optic 1            Light colour White            Required components:</p>		
<p><b>OSRAM</b> Opto Semiconductors</p> <p>LED OSTAR Stage (S2WN)            FWHM / FWTM 44.0 + 14.0° / 64.0 + 30.0°            Efficiency 87 %            Peak intensity 3.9 cd/lm            LEDs/each optic 1            Light colour RGBW            Required components:</p>		
<p><b>SAMSUNG</b></p> <p>LED LH231B            FWHM / FWTM 44.0 + 16.0° / 67.0 + 37.0°            Efficiency 86 %            Peak intensity 3.2 cd/lm            LEDs/each optic 1            Light colour White            Required components:</p>		

### PHOTOMETRIC DATA (MEASURED):



### PHOTOMETRIC DATA (SIMULATED):



LED XHP35 HI  
 FWHM / FWTM 11.0 + 42.0°  
 Efficiency 90 %  
 Peak intensity 5 cd/lm  
 LEDs/each optic 1  
 Light colour White  
 Required components:

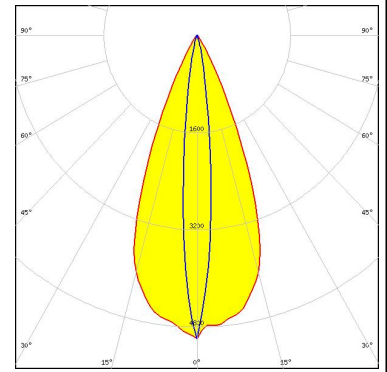

LED XP-G2  
 FWHM / FWTM 9.5 + 42.0°  
 Efficiency 90 %  
 Peak intensity 5.5 cd/lm  
 LEDs/each optic 1  
 Light colour White  
 Required components:

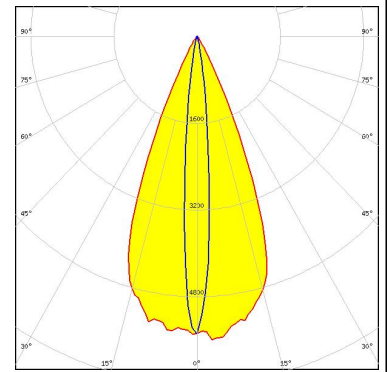

LED XP-G2 HE  
 FWHM / FWTM 42.0 + 12.0° / 60.0 + 26.0°  
 Efficiency 91 %  
 Peak intensity 4.7 cd/lm  
 LEDs/each optic 1  
 Light colour White  
 Required components:

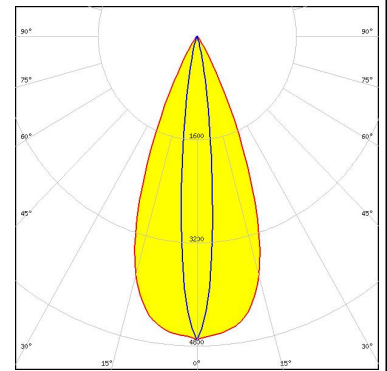

LED XP-L HI  
 FWHM / FWTM 12.0 + 42.0°  
 Efficiency 88 %  
 Peak intensity 4.2 cd/lm  
 LEDs/each optic 1  
 Light colour White  
 Required components:

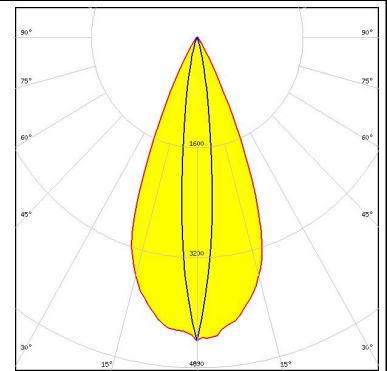

### PHOTOMETRIC DATA (SIMULATED):

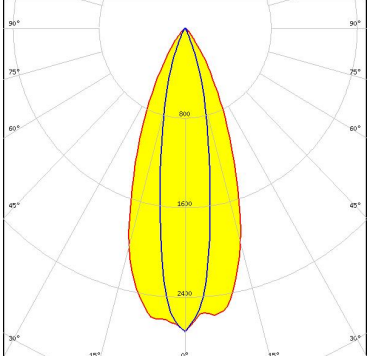
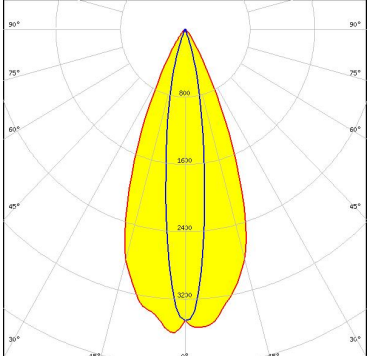
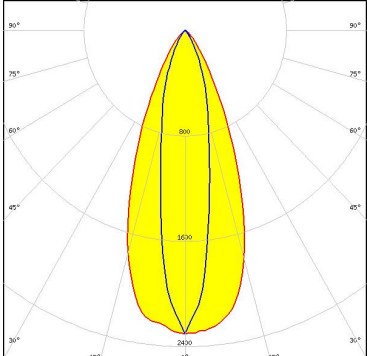
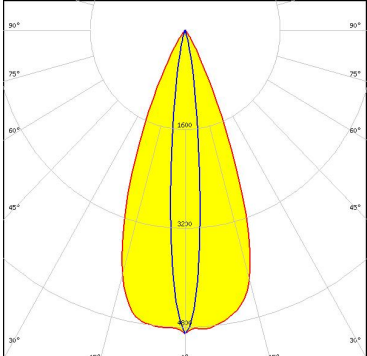
<p><b>LUMILEDS</b></p> <p>LED LUXEON M/MX            FWHM / FWTM 20.0 + 40.0°            Efficiency 86 %            Peak intensity 2.6 cd/lm            LEDs/each optic 1            Light colour White            Required components:</p>	
<p><b>NICHIA</b></p> <p>LED NV4WB35AM            FWHM / FWTM 42.0 + 16.0° / 64.0 + 36.0°            Efficiency 90 %            Peak intensity 3.6 cd/lm            LEDs/each optic 1            Light colour White            Required components:</p>	
<p><b>OSRAM</b> Opto Semiconductors</p> <p>LED Duris S10            FWHM / FWTM 42.0 + 20.0° / 72.0 + 54.0°            Efficiency 86 %            Peak intensity 2.3 cd/lm            LEDs/each optic 1            Light colour White            Required components:</p>	
<p><b>OSRAM</b> Opto Semiconductors</p> <p>LED OSOLON Square CSSRM2/CSSRM3            FWHM / FWTM 42.0 + 12.0° / 61.0 + 24.0°            Efficiency 90 %            Peak intensity 4.9 cd/lm            LEDs/each optic 1            Light colour White            Required components:</p>	

### GENERAL INFORMATION:

NOTE: The typical beam angle will be changed by different color, chip size and chip position tolerance. The typical total beam angle is the full angle measured where the luminous intensity is half of the peak value.

### MATERIALS:

As part of our continuous research and improvement processes, and to ensure the best possible quality and availability of our products, LEDiL reserves the right to change material grades without notice.

### PRODUCT DATA USER AGREEMENT AND DISCLAIMER:

The measured data in the provided downloadable LEDiL Product Datasheets and Mechanical 2D-Drawings is rounded and provided as reference for planning. LEDiL Oy's optical specifications have been verified by conducting performance testing of the products in accordance with the company's quality system. The reported data are averaged results of multiple measurements with typical variation. LEDiL Oy reserves the right to without prior notification make changes and improvements to its products.

LEDiL Oy assumes neither warranty, nor guarantee nor any other liability of any kind for the contents and correctness of the provided data. The provided data has been generated with highest diligence but the provided data may in reality not represent the complete possible variation range of all intrinsic parameters. Therefore, in certain cases a deviation from the provided data could occur.

LEDiL Oy reserves the right to undertake technical changes of its products without further notification which could lead to changes in the provided data. LEDiL Oy assumes no liability of any kind for the possible deviation from any provided data or any other damage resulting from the usage of the provided data.

The user agrees to this disclaimer and user agreement with the download or usage of the provided files.

#### LEDiL Oy

Joensuunkatu 13  
FI-24240 SALO  
Finland

#### LEDiL Inc.

228 West Page Street  
Suite D  
Sycamore IL 60178  
USA

#### Ledil Optics Technology (Shenzhen) Co., Ltd.

# 405 , Block B  
Casic Motor Building  
Shenzhen 518057  
P.R.CHINA

#### Local sales and technical support

[www.ledil.com/  
where\\_to\\_buy](http://www.ledil.com/where_to_buy)

#### Shipping locations

Salo, Finland  
Hong Kong, China

#### Distribution Partners

[www.ledil.com/  
where\\_to\\_buy](http://www.ledil.com/where_to_buy)