



User Manual

AIMB-223

**AIMB-223 Mobile AMD G-series
Dual Core/Single Core Mini-ITX
with VGA/LVDS/HDMI,6COM and
Dual LAN**

ADVANTECH

Enabling an Intelligent Planet

Copyright

The documentation and the software included with this product are copyrighted 2012 by Advantech Co., Ltd. All rights are reserved. Advantech Co., Ltd. reserves the right to make improvements in the products described in this manual at any time without notice. No part of this manual may be reproduced, copied, translated or transmitted in any form or by any means without the prior written permission of Advantech Co., Ltd. Information provided in this manual is intended to be accurate and reliable. However, Advantech Co., Ltd. assumes no responsibility for its use, nor for any infringements of the rights of third parties, which may result from its use.

Acknowledgements

AWARD is a trademark of Phoenix Technologies Ltd.

IBM and PC are trademarks of International Business Machines Corporation.

Intel® Atom™ N455/D525 is trademark of Intel Corporation

WinBond is a trademark of Winbond Corporation.

All other product names or trademarks are properties of their respective owners.

A Message to the Customer

Advantech Customer Services

Each and every Advantech product is built to the most exacting specifications to ensure reliable performance in the harsh and demanding conditions typical of industrial environments. Whether your new Advantech equipment is destined for the laboratory or the factory floor, you can be assured that your product will provide the reliability and ease of operation for which the name Advantech has come to be known.

Your satisfaction is our primary concern. Here is a guide to Advantech's customer services. To ensure you get the full benefit of our services, please follow the instructions below carefully.

Technical Support

We want you to get the maximum performance from your products. So if you run into technical difficulties, we are here to help. For the most frequently asked questions, you can easily find answers in your product documentation. These answers are normally a lot more detailed than the ones we can give over the phone.

So please consult this manual first. If you still cannot find the answer, gather all the information or questions that apply to your problem, and with the product close at hand, call your dealer. Our dealers are well trained and ready to give you the support you need to get the most from your Advantech products. In fact, most problems reported are minor and are able to be easily solved over the phone.

In addition, free technical support is available from Advantech engineers every business day. We are always ready to give advice on application requirements or specific information on the installation and operation of any of our products.

Declaration of Conformity

FCC Class B

This device complies with the requirements in part 15 of the FCC rules:

Operation is subject to the following two conditions:

- This device may not cause harmful interference
- This device must accept any interference received, including interference that may cause undesired operation.

This equipment has been tested and found to comply with the limits for a Class B digital device, pursuant to Part 15 of the FCC Rules. These limits are designed to provide reasonable protection against harmful interference when the equipment is operated in a commercial environment. This equipment generates, uses, and can radiate radio frequency energy and, if not installed and used in accordance with the instruction manual, may cause harmful interference to radio communications. Operation of this device in a residential area is likely to cause harmful interference in which case the user will be required to correct the interference at his/her own expense. The user is advised that any equipment changes or modifications not expressly approved by the party responsible for compliance would void the compliance to FCC regulations and therefore, the user's authority to operate the equipment.

Caution! *There is a danger of a new battery exploding if it is incorrectly installed. Do not attempt to recharge, force open, or heat the battery. Replace the battery only with the same or equivalent type recommended by the manufacturer. Discard used batteries according to the manufacturer's instructions.*



Memory Compatibility

Test Item	Description							Result	Remark
Brand	Size	Speed	Type	ECC	Vendor PN	Memory	Advantech PN		
Transcend	1GB	DDR31066	SODIMM DDR3	N	TS128MS K64V1U/ TS2KSU2 8200-1S	SEC K4B1G08 46D- HCF8(12 8x8)	96SD3- 1G1066NN- TR	PASS	
Transcend	1GB	DDR31066	SODIMM DDR3	N	TS128MS K64V1U	SEC HCH9 K4B1G08 46D(128x 8)	96SD3- 1G1066NN- TR	PASS	
Transcend	2GB	DDR31066	SODIMM DDR3	N	TS256MS K64V1U/ TS5KSU2 8400-1S	SEC K4B1G08 46D- HCF8(12 8x8)	96SD3- 2G1066NN- TR	PASS	
Transcend	2GB	DDR31066	SODIMM DDR3	N	TS128MS K64V1U	SEC HCH9 K4B1G08 46D (128x8)	96SD3- 2G1066NN- TR	PASS	
Transcend	4GB	DDR31066	SODIMM DDR3	N	TS7KSN2 8420-1Y	HYNIX H5TQ2G 83BFR (256x8)	96SD3- 4G1066NN- TR	PASS	
Apacer	1GB	DDR31066	SODIMM DDR3	N	78.02GC3 .420	ELPIDA J1108BD BG-DJ-F (128x8)	96SD3- 1G1066NN- AP	Limita- tion	
Apacer	2GB	DDR31066	SODIMM DDR3	N	78.A2GC3 .421	ELPIDA J1108BA BG-AE- E(128x8)	96SD3- 2G1066NN- AP	PASS	
Apacer	4GB	DDR31066	SODIMM DDR3	N	78.B2GC8 .AF1	HYNIX H5TQ2G 83BFR (256x8)	96SD3- 4G1066NN- AP	PASS	
Kingston	2GB	DDR31066	SODIMM DDR3	N	KVR1066 D3S7/2G	KVR1066 D3S7/2G (256x8)		PASS	
DSL	1GB	DDR31066	SODIMM DDR3	N		ELPIDA J1108BA SE-DJ-E (128x8)		Limita- tion	
DSL	4GB	DDR31066	SODIMM DDR3	N	D3SH560 82XH18A B	HYNIX H5TQ2G 83BFR (256x8)		PASS	
Micron	1GB	DDR31066	SODIMM DDR3	N	MT8JSF1 2864HZ- 1G1F1	Micron 9FF27 D9KPT (128x8)		PASS	

Samsung	2GB	DDR31066	SODIMM DDR3	N	M471B56 73DH1- CF8	SEC 904 HCF8 K4B1G08 46D (128x8)		PASS	
G.SKILL	4GB	DDR31066	SODIMM DDR3	N	F3- 8500CL7S -4GBSQ	HYNIX H5TQ2G 83AFR- G7C(256 X8)		PASS	
Transcend	1GB	DDR31333	SODIMM DDR3	N	TS128MS K64V3U	SEC 849 HCH9 K4B1G08 46D (128x8)		PASS	
Transcend	2GB	DDR31333	SODIMM DDR3	N	TS256MS K64V3U	SEC 904 HCF8 K4B1G08 46D (128x8)		PASS	
Transcend	4GB	DDR31333	SODIMM DDR3	N	TS512MS K64V3N	HYNIX H5TQ2G 83BFR (256x8)		PASS	
Apacer	1GB	DDR31333	SODIMM DDR3	N	78.02GC6 .420	ELPIDA J1108BD BG-DJ-F (128x8)	96SD3- 1G1333NN- AP	Limita- tion	
Apacer	2GB	DDR31333	SODIMM DDR3	N	78.A2GC6 .421	ELPIDA J1108BD BG-DJ-F (128x8)	96SD3- 2G1333NN- AP	PASS	
Apacer	4GB	DDR31333	SODIMM DDR3	N	78.B2GC9 .AF1	HYNIX H5TQ2G 83BFR (256x8)		PASS	
DSL	1GB	DDR31333	SODIMM DDR3	N	D3SE280 81XH15A A	ELPIDA J1108BD SE-DJ-F (128x8)		Limita- tion	
DSL	2GB	DDR31333	SODIMM DDR3	N	D3SE280 82XH15A A	ELPIDA J1108BD SE-DJ-F (128x8)		PASS	
DSL	4GB	DDR31333	SODIMM DDR3	N	D3SH560 82XH15A A	HYNIX H5TQ2G 83BFR (256x8)		PASS	
Kingston	1GB	DDR31333	SODIMM DDR3	N	KVR1333 D3S9/1G	E LPIDA J1108BD BG-DJ-F (128x8)		Limita- tion	
Kingston	2GB	DDR31333	SODIMM DDR3	N	KVR1333 D3S9/2G	E LPIDA J1108BD BG-DJ-F (128x8)		PASS	
ATP	4G B	DDR31333	SODIMM DDR3	N	AW12M64 F8BKH9S	SEC 019 HCH9 K4B2G08 46C (256x8)		PASS	

Ordering Information

Part Number	CPU	SC/DC	GbE	COM	LVDS
AIMB-223G2-S0A1E	T44R	Single core	2	6	1, 24/48bit
AIMB-223G2-S1A1E	T40E	Dual core	2	6	1, 24/48bit
AIMB-222G2-S2A1E	T56N	Dual core	2	6	1, 24/48bit

Product Warranty (2 years)

Advantech warrants to you, the original purchaser, that each of its products will be free from defects in materials and workmanship for two years from the date of purchase.

This warranty does not apply to any products which have been repaired or altered by persons other than repair personnel authorized by Advantech, or which have been subject to misuse, abuse, accident or improper installation. Advantech assumes no liability under the terms of this warranty as a consequence of such events.

Because of Advantech's high quality-control standards and rigorous testing, most of our customers never need to use our repair service. If an Advantech product is defective, it will be repaired or replaced at no charge during the warranty period. For out-of-warranty repairs, you will be billed according to the cost of replacement materials, service time and freight. Please consult your dealer for more details.

If you think you have a defective product, follow these steps:

1. Collect all the information about the problem encountered. (For example, CPU speed, Advantech products used, other hardware and software used, etc.) Note anything abnormal and list any onscreen messages you get when the problem occurs.
2. Call your dealer and describe the problem. Please have your manual, product, and any helpful information readily available.
3. If your product is diagnosed as defective, obtain an RMA (return merchandise authorization) number from your dealer. This allows us to process your return more quickly.
4. Carefully pack the defective product, a fully-completed Repair and Replacement Order Card and a photocopy proof of purchase date (such as your sales receipt) in a shippable container. A product returned without proof of the purchase date is not eligible for warranty service.
5. Write the RMA number visibly on the outside of the package and ship it prepaid to your dealer.

Initial Inspection

Before you begin installing your motherboard, please make sure that the following materials have been shipped:

- 1 x AIMB-223 AMD G-series mini-ITX motherboard
- 2 x SATA HDD cable
- 2 x SATA Power cable
- 1 x Serial port cable(1 to 4)
- 1 x I/O port bracket
- 1 x Startup manual
- 1 x Driver CD
- 1 x Warranty card
- 1 x CPU cooler

If any of these items are missing or damaged, contact your distributor or sales representative immediately. We have carefully inspected the AIMB-223 mechanically and electrically before shipment. It should be free of marks and scratches and in perfect working order upon receipt. As you unpack the AIMB-223, check it for signs of shipping damage. (For example, damaged box, scratches, dents, etc.) If it is damaged or it fails to meet the specifications, notify our service department or your local sales representative immediately. Also notify the carrier. Retain the shipping carton and packing material for inspection by the carrier. After inspection, we will make arrangements to repair or replace the unit.

Contents

Chapter 1	General Information	1
1.1	Introduction	2
1.2	Features	2
1.3	Specifications	3
1.3.1	Processor System	3
1.3.2	Expansion Slot	3
1.3.3	Memory	3
1.3.4	Graphic Interface	3
1.3.5	Ethernet Interface	3
1.3.6	SATA Interface	3
1.3.7	EIDE	3
1.3.8	SSD	3
1.3.9	Rear I/O	4
1.3.10	Internal Connector	4
1.3.11	Watchdog Timer	4
1.3.12	Power Requirement	4
1.3.13	Environment	4
1.3.14	Physical Characteristics	4
1.4	Jumpers and Connectors	5
	Table 1.1: Jumpers and Connectors	5
	Table 1.2: LVDS1	6
	Table 1.3: JBL3: Panel VDDSAFE PWR	7
	Table 1.4: JBL1: LVDS Inverter PWR	7
	Table 1.5: JBL8: BL controller from SIO	7
	Table 1.6: JBL6	7
	Table 1.7: JBL6	7
	Table 1.8: JWDT1+JOBS1	8
	Table 1.9: JFP1+JFP2	8
	Table 1.10: JFP3	8
	Table 1.11: CN21	8
	Table 1.12: GPIO1	8
	Table 1.13: ATX/AT	8
	Table 1.14: AAFP	9
	Table 1.15: SPDIF	9
	Table 1.16: JSETCOM3	9
	Table 1.17: COM port 3~6	9
	Table 1.18: USB56	10
	Table 1.19: USB78	11
	Table 1.20: CMOS	11
	Table 1.21: CN4	11
	Table 1.22: JCASE1	11
	Table 1.23: CPU_FAN/SYS_FAN	11
1.5	Board layout: Jumper and Connector Locations	12
	Figure 1.1 Jumper and Connector Location	12
	Figure 1.2 I/O Connectors	13
1.6	AIMB-223 Board Diagram	13
	Figure 1.3 AIMB-223 Board Diagram	13
1.7	Safety Precautions	14
1.8	Jumper Settings	15
1.8.1	How to Set Jumpers	15
1.8.2	CMOS Clear (CMOS1)	15
	Table 1.24: CMOS1	15
1.8.3	JBL3: LVDS power 3.3V/5V Selector	16
	Table 1.25: JBL3: LVDS power 3.3V/5V Selector	16

1.8.4	PSON1: ATX, AT Mode Selector	16
	Table 1.26: PSON1: ATX, AT Mode Selector	16
1.8.5	JWDT1: Watchdog Timer Output Option	16
	Table 1.27: JWDT1: Watchdog Timer Output Option.....	16
1.9	System Memory	17
1.10	Memory Installation Procedures	17

Chapter 2 Connecting Peripherals..... 19

2.1	Introduction	20
2.2	USB Ports (LAN1_USB01/LAN2_USB23/USB56/USB78)	20
	Table 2.1: LAN LED Indicator.....	20
2.3	VGA Connector (VGA1).....	21
2.4	Serial Ports (COM3~6).....	22
2.5	CPU Fan Connector (CPU_FAN1)	23
2.6	System FAN Connector (SYSFAN1)	23
2.7	Front Panel Connectors (JFP1+JFP2+JFP3)	24
2.7.1	ATX soft power switch ((JFP1+JFP2/ PWR_SW))	24
2.7.2	Reset (JFP1+JFP2/ RESET)	24
2.7.3	HDD LED (JFP1+JFP2/ HDDLED).....	24
2.7.4	External speaker (JFP1+JFP2/ SPEAKER)	24
2.7.5	Power LED and keyboard lock connector (JFP1 / PWR_LED & KEY LOCK).....	25
	Table 2.2: ATX power supply LED status (No support for AT power)	25
2.8	Line In, Line Out, Mic In Connector (AUDIO1).....	25
2.9	Serial ATA Interface (SATA1~4).....	26
2.10	PCI & PCI Express x1	26
2.11	ATX 12V Power Connector (CN19)	27
2.12	SPI Flash connector(CN4)	27
2.13	LCD Inverter Connector (JBL1)	28
2.14	LVDS Connector (LVDS1)	29
2.15	General purpose I/O Connector (GPIO1)	29

Chapter 3 BIOS Operation 31

3.1	Introduction	32
3.2	BIOS Setup	32
3.2.1	Main Menu	33
3.2.2	Advanced BIOS Features	34
3.2.3	Chipset.....	40
3.2.4	Boot	44
3.2.5	Security.....	45
3.2.6	Save & Exit	46

Chapter 4 Software Introduction & Service 47

4.1	Introduction	48
4.2	Value-Added Software Services	48
4.2.1	Software API.....	48
4.2.2	Software Utility.....	50

Chapter 5 Chipset Software Installation Utility 51

5.1	Before You Begin.....	52
5.2	Introduction	52
5.3	Windows XP Driver Setup.....	53

Chapter 6	VGA Setup.....	55
6.1	Introduction	56
6.2	Windows 7/XP	56
Chapter 7	LAN Configuration.....	57
7.1	Introduction	58
7.2	Features	58
7.3	Installation	58
7.4	Windows 7/XP Driver Setup.....	59
Appendix A	Programming the Watchdog Timer..	61
A.1	Programming the Watchdog Timer	62
A.1.1	Watchdog Timer Overview.....	62
A.1.2	Programming the Watchdog Timer	62
	Table A.1: Watchdog Timer Registers	64
A.1.3	Example Program	65
Appendix B	I/O Pin Assignments.....	69
B.1	USB Header (USB56, USB78).....	70
	Table B.1: USB Header (USB56).....	70
B.2	VGA Connector (VGA1)	70
	Table B.2: VGA Connector (VGA1)	70
B.3	RS-232 Interface (COM3/4/5/6)	71
	Table B.3: RS-232 Interface (COM3~COM6)	71
B.4	CN4: SPI Fresh Card Pin Connector	72
	Table B.4: CN4: SPI Fresh Card Pin Connector	72
B.5	CPU Fan Power Connector (CPU_FAN1)	72
	Table B.5: CPU Fan Power Connector (CPU_FAN1).....	72
B.6	System Fan Power Connector (SYS_FAN1)	72
	Table B.6: System Fan Power Connector (SYS_FAN1).....	72
B.7	Power LED & Keyboard Lock Connector (JFP3)	73
	Table B.7: Power LED & Keyboard Lock Connector (JFP3).....	73
B.8	Power switch/HDD LED/SMBus/Speaker (JFP1+JFP2)	73
	Table B.8: Power Switch/HDD LED/SMBus/Speaker (JFP1+JFP2)	73
B.9	USB/LAN ports (LAN1_USB12/LAN2_USB34).....	74
	Table B.9: USB Port.....	74
	Table B.10:Ethernet 10/100 Mbps RJ-45 Port	74
B.10	Line In, Line Out, Mic In Connector (AUDIO1).....	74
B.11	Serial ATA0/1 (SATA 1/2/3/4)	74
	Table B.11:Serial ATA 0/1 (SATA 1/2/3/4).....	74
B.12	AT/ATX Mode (PSON1)	75
	Table B.12:AT/ATX Mode (PSON1)	75
B.13	GPIO Pin Header (GPIO1).....	75
	Table B.13:GPIO Pin Header (GPIO1)	75
B.14	LVDS Connector: LVDS1	75
	Table B.14:LVDS1 Connector.....	76
B.15	LVDS Power Jumper (JBL3)	76
	Table B.15:LVDS Power Jumper	76
B.16	LVDS Inverter (JBL1)	77
	Table B.16:LVDS Power Jumper	77
B.17	ATX 12 V connector (ATX12V_1)	77
	Table B.17:ATX 12 V connector (ATX12V_1).....	77

Chapter 1

General Information

1.1 Introduction

The AIMB-223 board comes with high connectivity and a variety of expansion options including: a single PCIe x1 and PCI expansion slot, six serial ports, four SATA III 600 MB/s connectors, and eight USB 2.0 ports. Dual display output is supported with several output interface options: VGA, HDMI, and LVDS (LVDS supports 3.3V, 5V, and 12V for large sized panels). AIMB-223 also comes with software RAID 0, 1, 5 and 10 support, offering abundant data storage and reliable data protection, as well as dual PCI Express based Gigabit (Realtek 8111DL) Ethernet ports delivering up to 1000 Mbps of bandwidth for network-intensive applications. AIMB-223 has designed in both ATX12V and DC IN power to provide a low total cost solution. All this connectivity is packed into a space-saving, power-efficient, and cost-effective Mini-ITX form factor.

With the graphics engine integrated onto the processor chip, these two-chip solutions provide enhanced graphics performance compared to previous AMD platforms. The integrated graphics controller includes AMD's first Fusion architecture accelerated processing unit which can also support dual channel 24-bit LVDS for large sized panels.

1.2 Features

- **Rich I/O connectivity:** 4 serial ports, 8 USB 2.0, Dual GbE LAN
- **Standard Mini-ITX form factor with industrial feature:** The AIMB-223 is a full-featured Mini-ITX motherboard with balanced expandability and performance
- **Wide selection of storage devices:** SATA HDD, CFast, customers benefit from the flexibility of using the most suitable storage device for larger capacity
- **Optimized integrated graphic solution:** With AMD ATI Radeon HD6310, Support DirectX 11, UVD3.

1.3 Specifications

1.3.1 Processor System

- **CPU:** AMD Dual Core T56N / AMD Dual Core T40E / AMD Single Core T44R
- **Max. Speed:** 1.65 GHz (dual core 18W TDP) / 1.0 GHz (dual core 6W TDP) / 1.2 GHz (Single core 9W TDP)
- **L2 Cache:** 512 KB
- **Chipset:** AMD G-series + A55E
- **BIOS:** AMI 16 Mbit SPI

1.3.2 Expansion Slot

- **PCI:** 1
- **Mini-PCIe:** 1
- **PCIe:** PCIe x1 (PCIe gen2)

1.3.3 Memory

- **Technology:** One channels DDR3 1333/1066 MHz
- **Max. Capacity:** 4 GB
- **Socket:** 1 x 204 pin SODIMM

1.3.4 Graphic Interface

- **Controller:** ATI Radeon HD 6310, support DirectX 11, UVD3
- **VRAM:** TBD
- **VGA:** Supports up to 2560 x 1536 @ 32bpp
- **LVDS:** Supports 24-bit dual channel and up to 1920 x 1200
- **HDMI:** 1920 x 1200 @ 60 MHz
- **Dual Display:** Supports dual display of any two display device (CRT, LVDS, HDMI)

1.3.5 Ethernet Interface

- **Interface:** 10/100/1000 Mbps
- **Controller:** GbE LAN1: RTL8111DL; GbE LAN2: RTL8111DL
- **Connector:** RJ-45 x 2

1.3.6 SATA Interface

- **Max Data Transfer Rate:** 600 MB/s
- **Channel:** 4

1.3.7 EIDE

- **Mode:** None
- **Channel:** None

1.3.8 SSD

- **Cfast compactFlash:** Cfast type I/II

1.3.9 Rear I/O

- **VGA:** 1
- **HDMI:** 1
- **Ethernet:** 2
- **USB:** 4 (USB 2.0 compliant)
- **Audio:** 3 (Mic-in, Line-out, Line-in)
- **Serial:** 2 (RS-232)
- **DC jack:** 1 (2.5 mm)

1.3.10 Internal Connector

- **LVDS & Inverter:** 1
- **USB:** 4 (USB 2.0 compliant)
- **Serial:** 4 (RS-232, COM3 support 5V/12V by jumper selection)
- **IDE:** None
- **SATA:** 4
- **Cfast compactFlash:** 1
- **Parallel:** None
- **GPIO:** 8-bit

1.3.11 Watchdog Timer

- **Output:** System reset
- **Interval:** Programmable 1 ~ 255 sec/min

1.3.12 Power Requirement

- **Typical:**
 - Single Voltage 12V DC input by 1x External DC phone Jack or 1x Internal 2x2-pin Power Connector;
 - AT/ATX Supported by Jumper
 - Max power consumption:47.57W (T56N +4G DDR3 RAM)

1.3.13 Environment

- **Temperature:**
 - 0 ~ 60° C (32 ~ 140° F), Operating
 - -40 ~ 85° C (-40 ~ 185° F), Non-operating

1.3.14 Physical Characteristics

- **Dimensions:** 170 mm x 170 mm (6.69" x 6.69")

1.4 Jumpers and Connectors

Connectors on the AIMB-223 motherboard link it to external devices such as hard disk drives and a keyboard. In addition, the board has a number of jumpers used to configure your system for your application.

The tables below list the function of each of the board jumpers and connectors. Later sections in this chapter give instructions on setting jumpers. Chapter 2 gives instructions for connecting external devices to your motherboard.

Table 1.1: Jumpers and Connectors

Label	Function
AAFP	Front panel audio connector
AUDIO1	Audio connector
CMOS1	CMOS clear (Default 1-2)
CN1	Memory connector channel
CN17	CFast socket
COM3-6	Serial port: COM RS232
CPU_FAN1	CPU FAN connector(3-pin)
GPIO1	GPIO header
CN18	DC IN
CN19	ATX 12 V connector
CN21	PS_ON , 5VSB
JBL1	LVDS1 inverter power
JBL8	Brightness control selector for analog or digital (Default 1-2, Analog)
JBL3	LVDS1 voltage jumper (default 1-2, 3.3V)
JCASE1	CASE open setting
JFP1+JFP2	Power switch/HDD LED/SMBus/speaker
JFP3	Power LED and keyboard lock
JBL6	LVDS1 PIN40 . Default 2-3
JSETCOM3	COM3 5 V/12 V jumper setting
PCIE1	PCI express X1 connector
CN20	PS/2 keyboard and mouse connector
LAN1_USB12	LAN1 / USB port 1, 2
LAN2_USB34	LAN2 / USB port 3, 4
LVDS1	LVDS connector (Internal)
MINIPCI1	Mini PCI express connector
PCI	PCI slot
PERSON1	AT(1-2) / ATX(2-3) (Default 2-3)
SATA1	Serial ATA data connector 1
SATA2	Serial ATA data connector 2
SATA3	Serial ATA data connector 3
SATA4	Serial ATA data connector 4
SATA_PWR1	SATA POWER
SATA_PWR2	SATA POWER
CN4	SPI flash update connector.
SPDIF_OUT	Digital Audio connector
SYS_FAN1	System FAN connector(3-pin)
USB56	USB port 5, 6 (on board)

Table 1.1: Jumpers and Connectors

USB78	USB port 7, 8 (on board)
HDMI	HDMI connector
VGA	VGA connector
COM12-1	COM PORT CONNECTOR
COM12-2	COM PORT CONNECTOR
JOBS1	OBS alarm
JWDT1	Watchdog reset

Table 1.2: LVDS1

Pin	Signal
1	VDDSAFE
2	VDDSAFE
3	GND
4	GND
5	VDDSAFE
6	VDDSAFE
7	LVDS_L0_N
8	LVDS_U0_N
9	LVDS_L0_P
10	LVDS_U0_P
11	GND
12	GND
13	LVDS_L1_N
14	LVDS_U1_N
15	LVDS_L1_P
16	LVDS_U1_P
17	GND
18	GND
19	LVDS_L2_N
20	LVDS_U2_N
21	LVDS_L2_P
22	LVDS_U2_P
23	GND
24	GND
25	LVDS_CLKL_N
26	LVDS_CLKU_N
27	LVDS_CLKL_P
28	LVDS_CLKU_P
29	GND
30	GND
31	LVDS_DDC_CLK
32	LVDS_DDC_DATA
33	GND
34	GND
35	LVDS_L3_N
36	LVDS_U3_N

Table 1.2: LVDS1

37	LVDS_L3_P
38	LVDS_U3_P
39	LVDS_BL_EN
40	VCON

Table 1.3: JBL3: Panel VDDSAFE PWR

Pin	Signal
1-2	3V
2-3	5V

Table 1.4: JBL1: LVDS Inverter PWR

Pin	Signal
1	+12V
2	GND
3	BL_EN
4	BL_PWM
5	+5V

Table 1.5: JBL8: BL controller from SIO

Pin	Signal
1	SIO_LVSO_VBR
2	GND
3	NC

Table 1.6: JBL6

Pin	Signal
1	3.3V
2	VCON
3	GND

Table 1.7: JBL6

Pin	Signal
1	3.3V
2	VCON
3	GND

Table 1.8: JWDT1+JOBS1

Pin	Signal
1	NC
2	SIO_WG
3	SYS_RST
4	ERR_BEEP
5	BEEP

Table 1.9: JFP1+JFP2

Pin	Signal	Pin	Signal	Pin	Signal
1	+5V	2	HDLED+	3	PWRBT
4	NC	5	HDLED-	6	PULL LOW
7	SPK_P3	8	I2C DATA	9	SYS_RST
10	SPK_P4	11	I2CCLK	12	GND
7-10	EN_SPK1	3-6	POWER BT		
1-10	EXT_SPK	9-12	SYS_RESET		

Table 1.10: JFP3

Pin	Signal	Pin	Signal
1	POWER LED	4	KEYLOCK
2	NC	5	GND
3	GND		

Table 1.11: CN21

Pin	Signal
1	5VSB_IN
2	GND
3	PS_ON#

Table 1.12: GPIO1

Pin	Signal	Pin	Signal
1	DIO0	2	DIO4
3	DIO1	4	DIO5
5	DIO2	6	DIO6
7	DIO3	8	DIO7
9	+5V	10	GND

Table 1.13: ATX/AT

Pin	Signal
2-3	ATX mode
1-2	AT mode

Table 1.14: AAFP

Pin	Signal
1	MIC2_L
2	GND
3	MIC2_R
4	PRESENSE
5	LIN2_R
6	SENSE1_RTN
7	SENSE_B
9	LIN2_L
10	SENSE2_RTN

Table 1.15: SPDIF

Pin	Signal
1	+5V
3	SPDIF_O
4	GND

Table 1.16: JSETCOM3

Pin	Signal	Pin	Signal
1	COM3P9SEL	2	RR13
3	COM3P9SEL	4	5V
5	COM3P9SEL	6	12V

Table 1.17: COM port 3~6

Pin	Signal
1	DCCD3_N
2	DDSR3_N
3	RRXD3
4	RRTS3
5	TTXD3
6	CCTS3_N
7	DDTR3_N
8	COM3P9SEL
9	GND
10	GND
11	DCCD4_N
12	DDSR4_N
13	RRXD4
14	RRTS4_N
15	TTXD4
16	CCTS4_N
17	DDTR4_N
18	RRI4

Table 1.17: COM port 3~6

19	GND
20	GND
21	DDCD5_N
22	DDSR5_N
23	RRXD5
24	RRTS5_N
25	TTXD5
26	CCTS5_N
27	DDTR5_N
28	RRI5
29	GND
30	GND
31	DDCD6_N
32	DDSR6_N
33	RRXD6
34	RRTS6_N
35	TTXD6
36	CCTS6_N
37	DDTR6_N
38	RRI6
39	GND
40	GND

Table 1.18: USB56

Pin	Signal
1	+5VPWR
2	+5VPWR
3	USBD4-
4	USBD5-
5	USBD4+
6	USBD5+
7	GND
8	GND
10	GND

Table 1.19: USB78

Pin	Signal
1	+5VPWR
2	+5VPWR
3	USB4-
4	USB5-
5	USB4+
6	USB5+
7	GND
8	GND
10	GND

Table 1.20: CMOS

Pin	Signal
1	VBAT
2	VBAT_IN
3	PULL LO
1-2	NORMAL
2-3	CMOS CLEAR

Table 1.21: CN4

Pin	Signal	Pin	Signal
8	NC		
6	SPI_MOSI	5	SPI_MISO
4	SPI_CLK	3	SPI_CS#
2	GND	1	SPI_PWR

Table 1.22: JCASE1

Pin	Signal
1	CASEOP IN
2	GND

Table 1.23: CPU_FAN/SYS_FAN

Pin	Signal
1	GND
2	+12VPWM
3	Sensor

1.5 Board layout: Jumper and Connector Locations

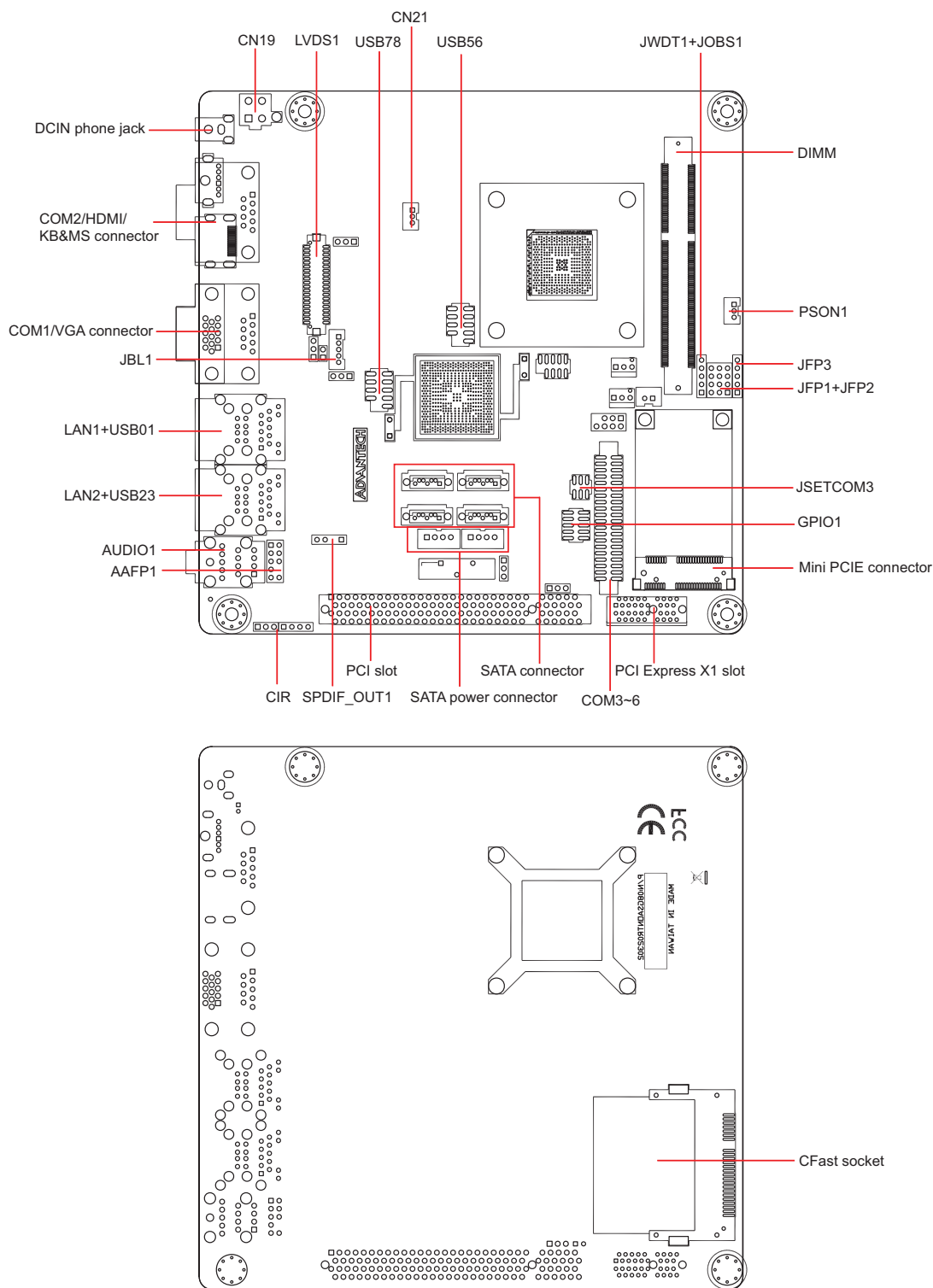

Figure 1.1 Jumper and Connector Location



Figure 1.2 I/O Connectors

1.6 AIMB-223 Board Diagram

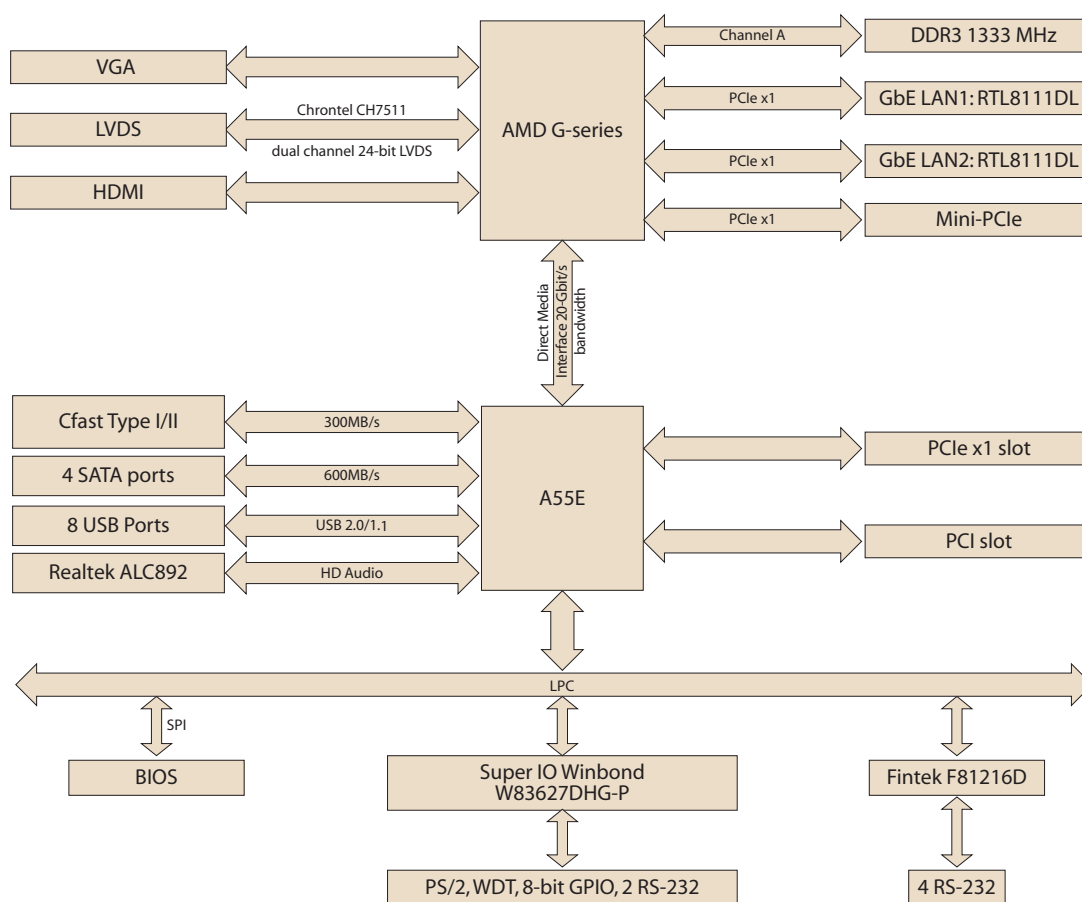

Figure 1.3 AIMB-223 Board Diagram

1.7 Safety Precautions

Warning! *Always completely disconnect the power cord from chassis whenever you work with the hardware. Do not make connections while the power is on. Sensitive electronic components can be damaged by sudden power surges. Only experienced electronics personnel should open the PC chassis.*



Caution! *Always ground yourself to remove any static charge before touching the motherboard. Modern electronic devices are very sensitive to electrostatic discharges. As a safety precaution, use a grounding wrist strap at all times. Place all electronic components on a static-dissipative surface or in a static-shielded bag when they are not in the chassis.*



Caution! *The computer is provided with a battery-powered real-time clock circuit. There is a danger of explosion if battery is incorrectly replaced. Replace only with same or equivalent type recommended by the manufacturer. Discard used batteries according to manufacturer's instructions.*



Caution! *There is a danger of a new battery exploding if it is incorrectly installed. Do not attempt to recharge, force open, or heat the battery. Replace the battery only with the same or equivalent type recommended by the manufacturer. Discard used batteries according to the manufacturer's instructions.*



1.8 Jumper Settings

This section provides instructions on how to configure your motherboard by setting the jumpers. It also includes the motherboards's default settings and your options for each jumper.



1.8.1 How to Set Jumpers

You can configure your motherboard to match the needs of your application by setting the jumpers. A jumper is a metal bridge that closes an electrical circuit. It consists of two metal pins and a small metal clip (often protected by a plastic cover) that slides over the pins to connect them. To “close” (or turn ON) a jumper, you connect the pins with the clip. To “open” (or turn OFF) a jumper, you remove the clip. Sometimes a jumper consists of a set of three pins, labeled 1, 2, and 3. In this case you connect either pins 1 and 2, or 2 and 3. A pair of needle-nose pliers may be useful when setting jumpers.

1.8.2 CMOS Clear (CMOS1)

The AIMB-223 motherboard contains a jumper that can erase CMOS data and reset the system BIOS information. Normally this jumper should be set with pins 1-2 closed. If you want to reset the CMOS data, set J1 to 2-3 closed for just a few seconds, and then move the jumper back to 1-2 closed. This procedure will reset the CMOS to its default setting.

Table 1.24: CMOS1

Function	Jumper Setting
*Keep CMOS data	 1-2 closed
Clear CMOS data	 2-3 closed

* Default

1.8.3 JBL3: LVDS power 3.3V/5V Selector

Table 1.25: JBL3: LVDS power 3.3V/5V Selector

Closed Pins	Result
JBL3	
1-2*	For 3.3 V LVDS Panel
2-3	For 5 V LVDS Panel

*Default

JBL3  for 3.3V LVDS panel

JBL3  for 5V LVDS panel

1.8.4 PSON1: ATX, AT Mode Selector

Table 1.26: PSON1: ATX, AT Mode Selector

Closed Pins	Result
1-2	AT Mode
2-3*	ATX Mode

*Default

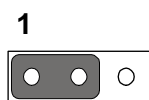

AT Mode
1-2 closed

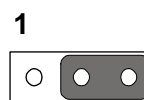

ATX Mode
2-3 closed

1.8.5 JWDT1: Watchdog Timer Output Option

Table 1.27: JWDT1: Watchdog Timer Output Option

Closed Pins	Result
1-2	NC
2-3*	System Reset*

*Default

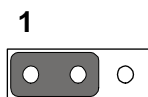

NC
1-2 closed

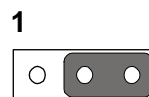

System Reset
2-3 closed

1.9 System Memory

The AIMB-223 has one socket for a 204-pin SODIMM.

This socket uses a 1.5 V unbuffered double-data-rate three synchronous DRAM (DDR3 SDRAM). DRAM is available in capacities of 512 MB, 1 GB and 2 GB. The socket can be filled in any combination with DIMMs of any size, giving a total memory size between 512 MB and 4 GB. AIMB-223 does NOT support ECC (error checking and correction).

1.10 Memory Installation Procedures

To install SODIMMs, first make sure the handle of the SODIMM socket are in the “open” position, i.e., the handles lean outward. Slowly slide the SODIMM module along the plastic guides on both ends of the socket. Then press the SODIMM module well down into the socket, until you hear a click when the two handles have automatically locked the memory module into the correct position of the SODIMM socket. To remove the memory module, just push both handles outward, and the memory module will be ejected by the mechanism.

Chapter 2

Connecting
Peripherals

2.1 Introduction

You can access most of the connectors from the top of the board as it is being installed in the chassis. If you have a number of cards installed or have a packed chassis, you may need to partially remove the card to make all the connections.

2.2 USB Ports (LAN1_USB01/LAN2_USB23/USB56/USB78)

The AIMB-223 provides up to eight USB ports. The USB interface complies with USB Specification Rev. 2.0 supporting transmission rate up to 480 Mbps and is fuse protected. The USB interface can be disabled in the system BIOS setup.

The AIMB-223 is equipped with one high-performance 1000 Mbps Ethernet LAN adapter, and one 100 Mbps LAN adapter, both of which are supported by all major network operating systems. The RJ-45 jacks on the rear panel provide for convenient LAN connection.

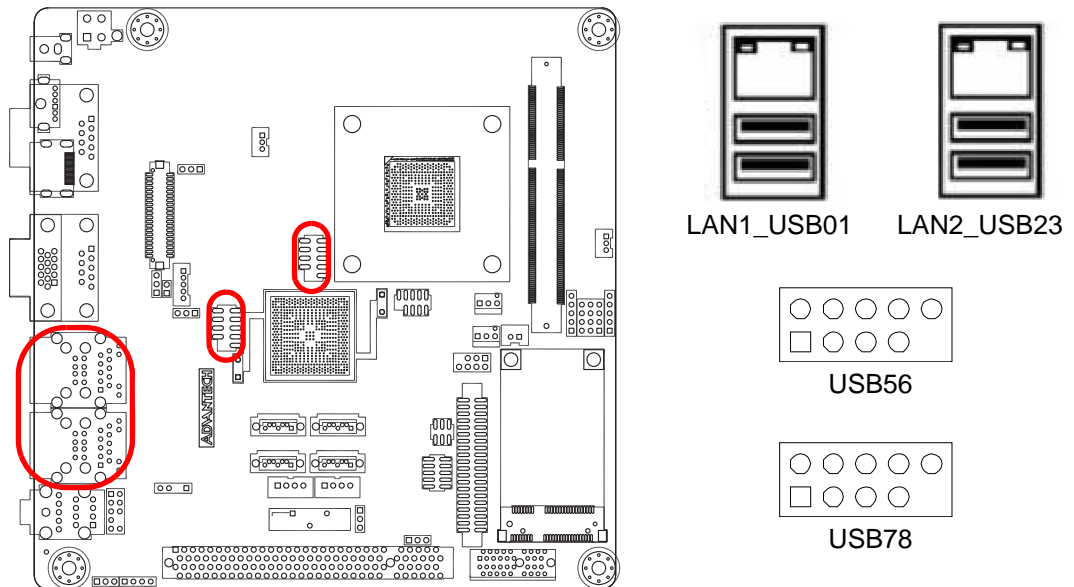
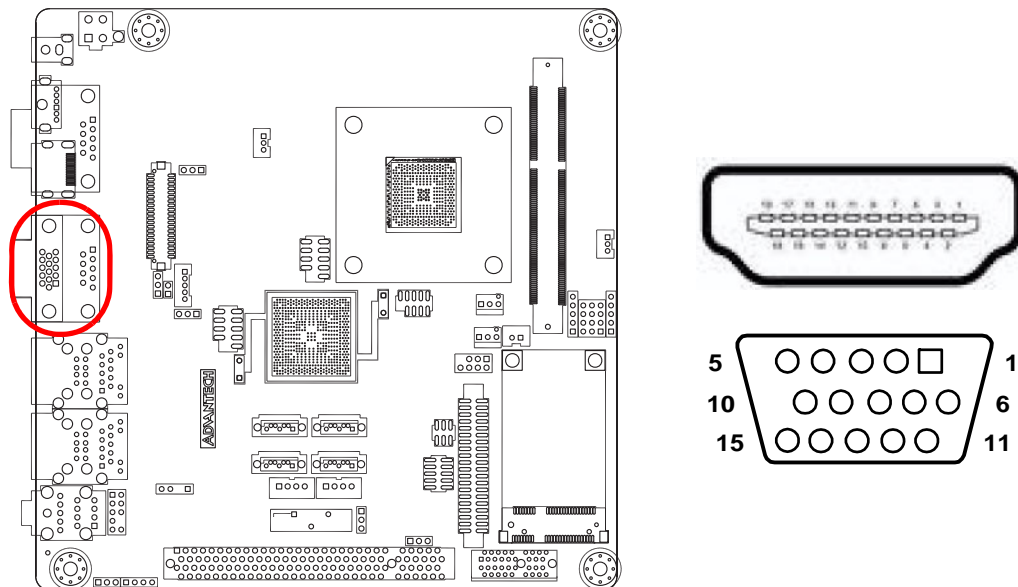

Table 2.1: LAN LED Indicator

LAN Mode	Lan Indicator
1 Gbps Link on	LED1 Green on
100 Mbps Link on	LED1 Orange on
Active	LED2 Green flash

2.3 VGA Connector (VGA1)



The AIMB-223 includes VGA and HDMI interface that can drive conventional VGA and HDMI displays. VGA1 is a standard 15-pin D-SUB connector commonly used for VGA. HDMI is HDMI connector for HDMI signals output. Pin assignments for VGA are detailed in Appendix B.

2.4 Serial Ports (COM3~6)

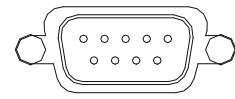
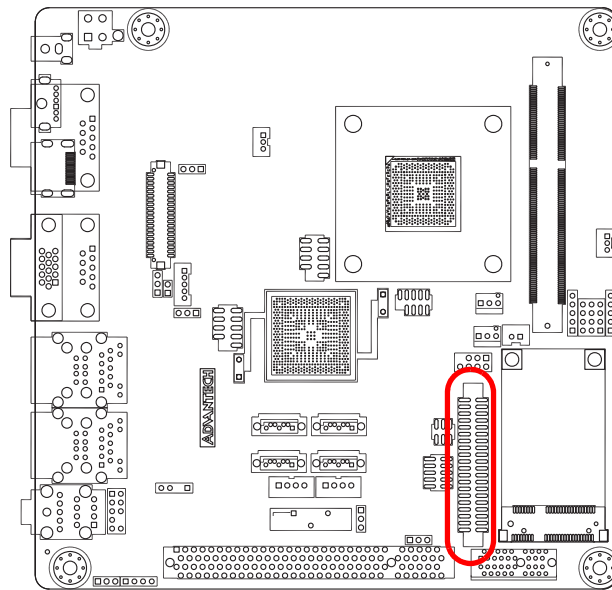

COM12

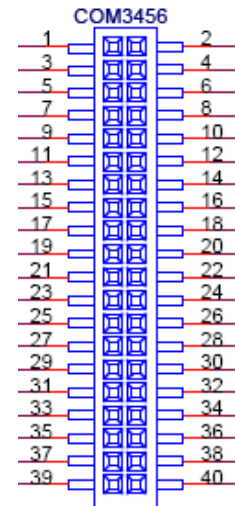

AIMB-223 supports six serial ports. 1 of RS-232 - COM1, COM2, COM3, COM4, COM5 and COM6. These ports can connect to serial devices, such as a mouse or a printer, or to a communications network.

The IRQ and address ranges for both ports are fixed. However, if you want to disable the port or change these parameters later, you can do this in the system BIOS setup.

2.5 CPU Fan Connector (CPU_FAN1)

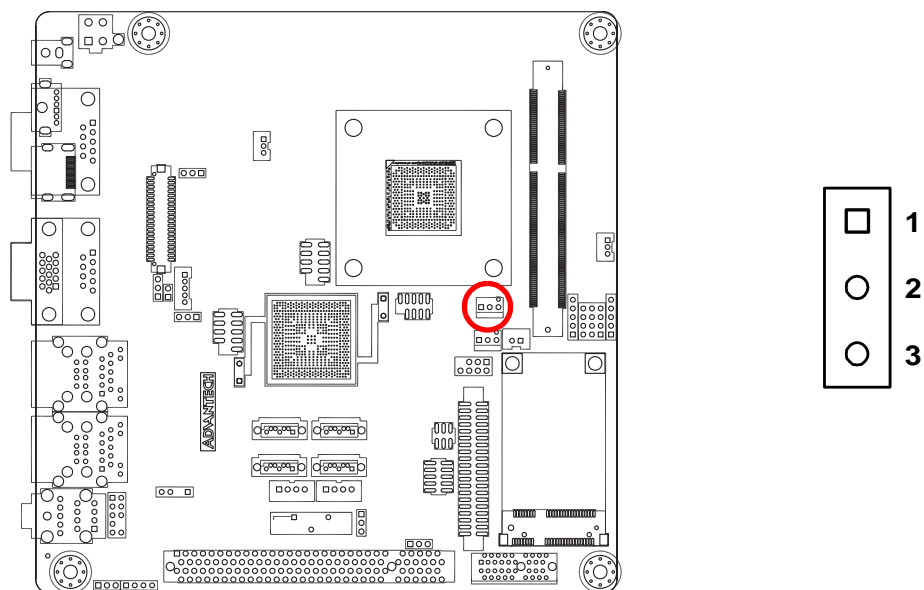

If a fan is used, this connector supports cooling fans of 500 mA (6 W) or less.

2.6 System FAN Connector (SYSFAN1)

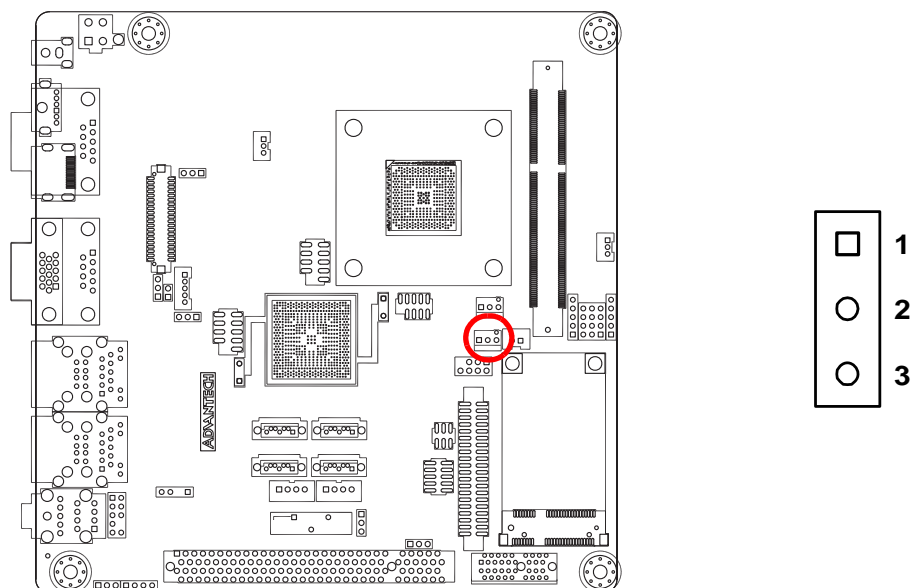

If a fan is used, this connector supports cooling fans of 500 mA (6 W) or less.

2.7 Front Panel Connectors (JFP1+JFP2+JFP3)

There are several external switches to monitor and control the AIMB-223.

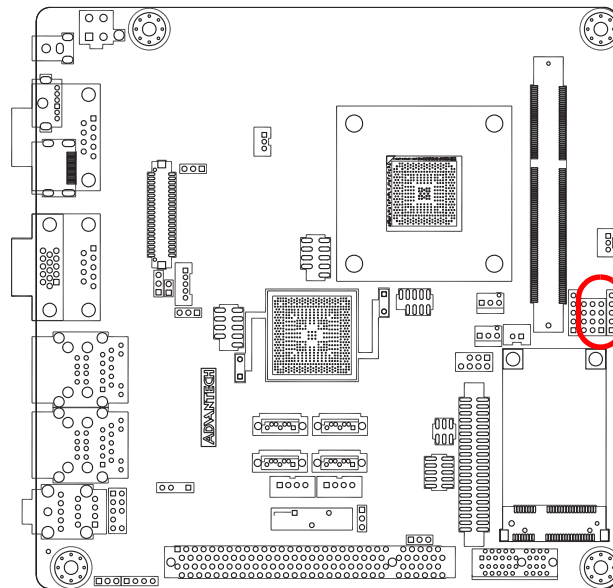

JFP1 & JFP2	3	6	9	12	
	2	5	8	11	
	1	4	7	10	
JFP3	1	2	3	4	5

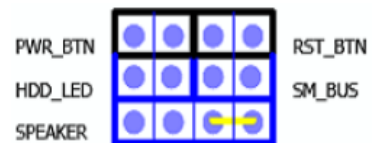

2.7.1 ATX soft power switch ((JFP1+JFP2/ PWR_SW))

If your computer case is equipped with an ATX power supply, you should connect the power on/off button on your computer case to ((JFP1+JFP2/ PWR_SW)), for convenient power on and off.

2.7.2 Reset (JFP1+JFP2/ RESET)

Many computer cases offer the convenience of a reset button. Connect the wire for the reset button.

2.7.3 HDD LED (JFP1+JFP2/ HDDLED)

You can connect an LED to connector (JFP2/HDDLED) to indicate when the HDD is active.

2.7.4 External speaker (JFP1+JFP2/ SPEAKER)

((JFP1+JFP2/ SPEAKER)) is a 4-pin connector for an external speaker. If there is no external speaker, the AIMB-223 provides an onboard buzzer as an alternative. To enable the buzzer, set pins 7-10 as closed.

2.7.5 Power LED and keyboard lock connector (JFP1 / PWR_LED & KEY LOCK)

(JFP1 / PWR_LED & KEY LOCK) is a 5-pin connector for the power on LED and Key Lock function. Refer to Appendix B for detailed information on the pin assignments. The Power LED cable should be connected to pin 1-3. The key lock button cable should be connected to pin 4-5.

There are 3 modes for the power supply connection. The first is “ATX power mode”; the system turns on/off by a momentary power button. The second is “AT Power Mode”; the system turns on/off via the power supply switch. The third is another “AT Power Mode” which makes use of the front panel power switch. The power LED status is indicated in the following table:

Table 2.2: ATX power supply LED status (No support for AT power)

Power mode	LED (ATX Power Mode) (On/off by momentary button)	LED (AT power Mode) (On/off by switching power supply)	LED (AT power Mode) (On/off by front panel switch)
PSON1 (on back plane) jumper setting	pins 2-3 closed	pins 1-2 closed	Connect pins 1 & 2 to panel switch via cable
System On	On	On	On
System Suspend	Fast flashes	Fast flashes	Fast flashes
System Off	Slow flashes	Off	Off

2.8 Line In, Line Out, Mic In Connector (AUDIO1)

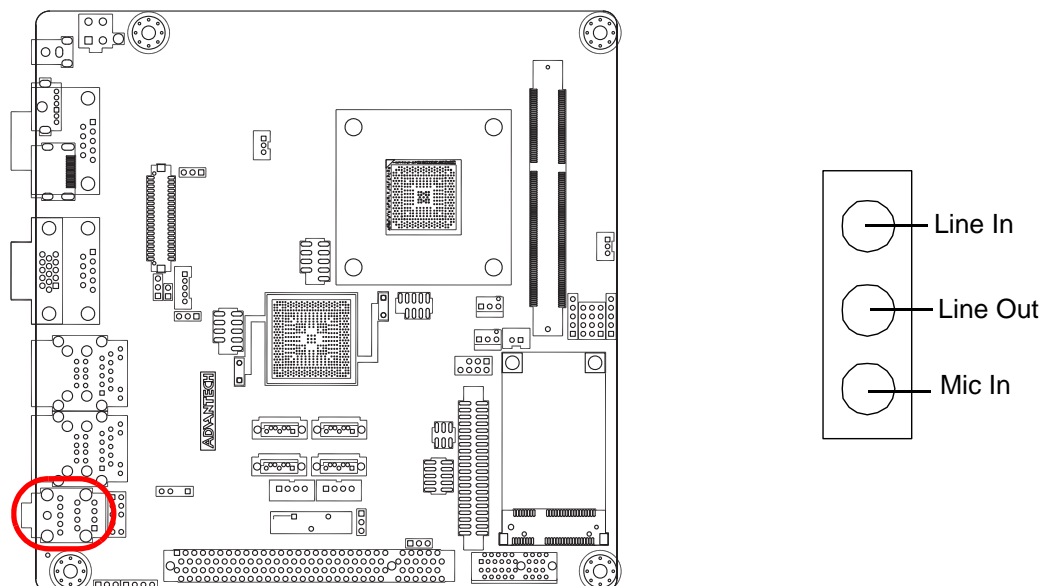

2.9 Serial ATA Interface (SATA1~4)

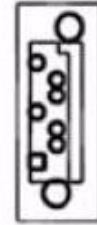
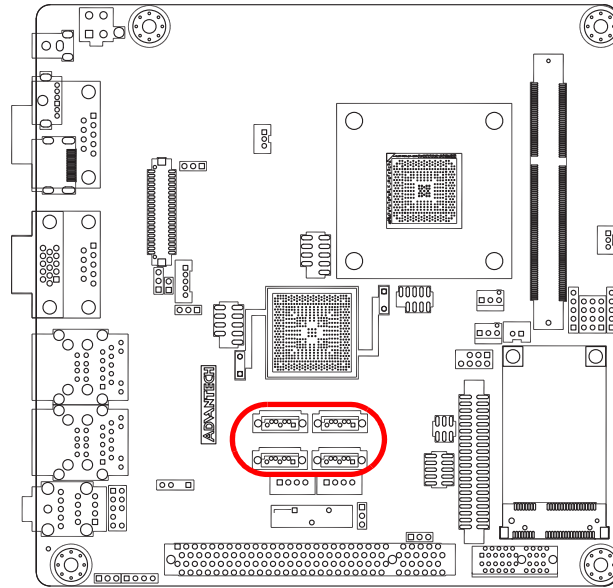

AIMB-223 features a high performance Serial ATA interface (up to 300 MB/s) which eases cabling to hard drives with long, thin cables.

2.10 PCI & PCI Express x1

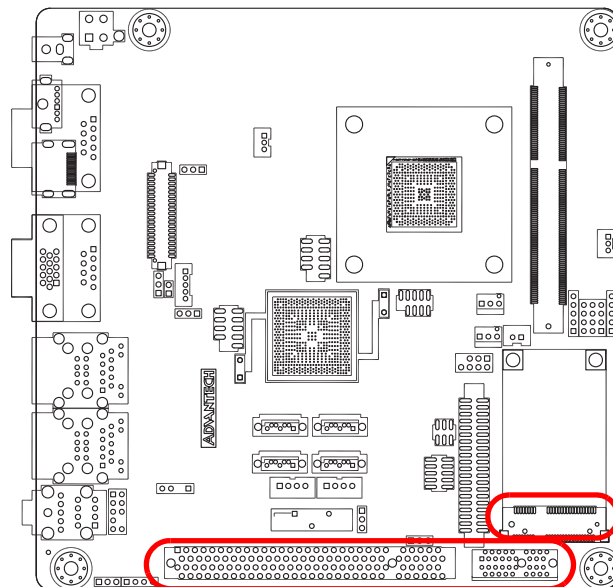

AIMB-223 provides 1x PCI and 1x PCIe x1 slot.

2.11 ATX 12V Power Connector (CN19)

This connector is for an ATX Micro-Fit power supply. The plugs from the power supply are designed to fit these connectors in only one direction. Determine the proper orientation and push down firmly until the connectors mate completely.

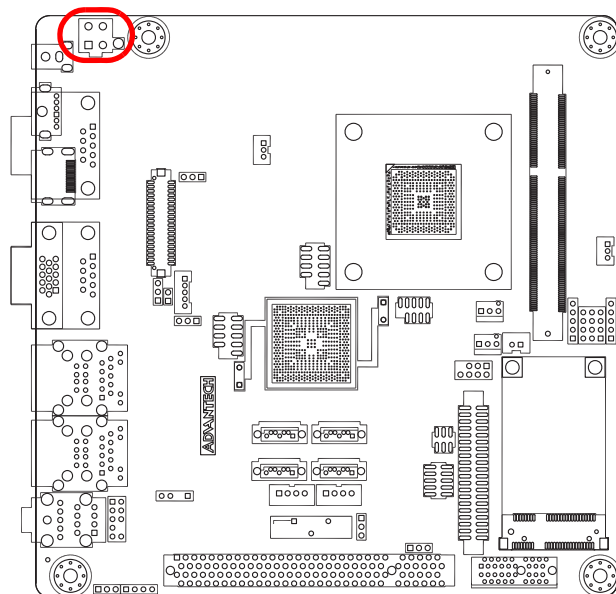

2.12 SPI Flash connector(CN4)

The SPI flash card pin header may be used to flash BIOS if the AIMB-223 cannot power on.

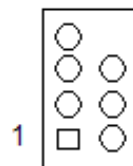
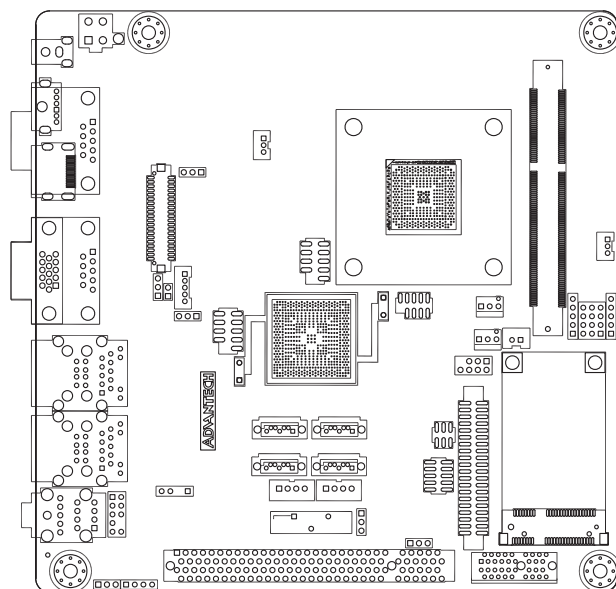

2.13 LCD Inverter Connector (JBL1)

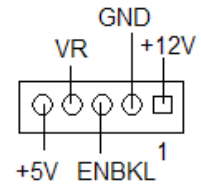
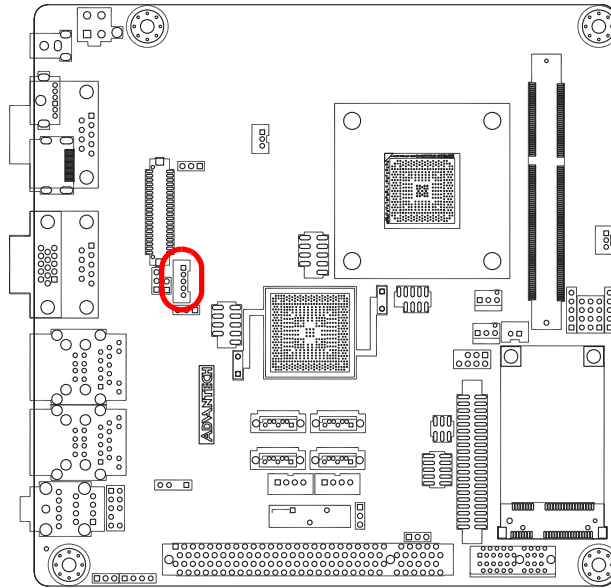

Note! ■ **Signal Description**



Signal

VR

ENBKL

Signal Description

$V_{adj}=0.75\text{ V}$

(Recommended: $4.7\text{ K}\Omega$, $>1/16\text{ W}$)

LCD backlight ON/OFF control signal

2.14 LVDS Connector (LVDS1)

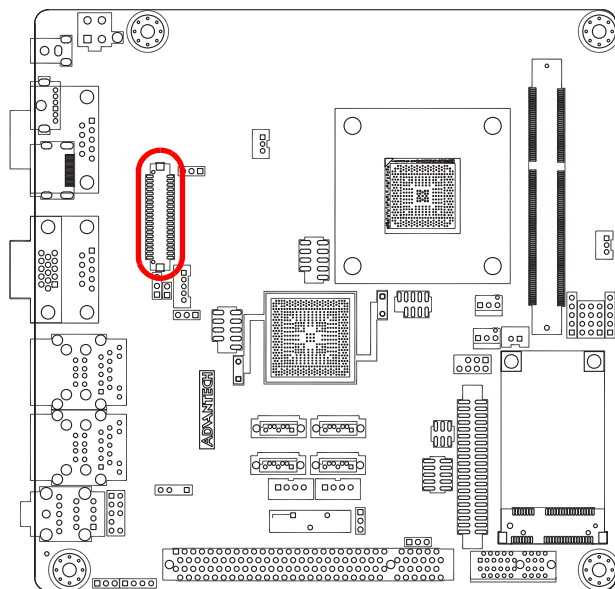

LVDS 1

VDDSAFE_1	□	VDDSAFE_2	○
GND_1	○	GND_7	○
VDDSAFE_3	○	VDDSAFE_4	○
OD0-	○	NC	○
OD0+	○	NC	○
GND_2	○	GND_8	○
OD1-	○	NC	○
OD1+	○	NC	○
GND_3	○	GND_9	○
OD2-	○	NC	○
OD2+	○	NC	○
GND_4	○	GND_10	○
OCK-	○	NC	○
OCK+	○	NC	○
GND_5	○	GND_11	○
DDC_CLK	○	DDC_DAT	○
GND_6	○	GND_12	○
OD3-	○	NC	○
OD3+	○	NC	○
HPLG	○	VCON	○

2.15 General purpose I/O Connector (GPIO1)

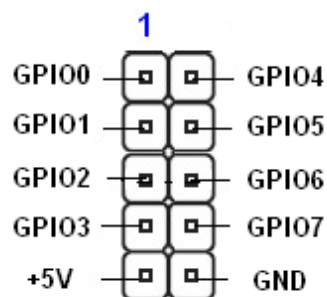
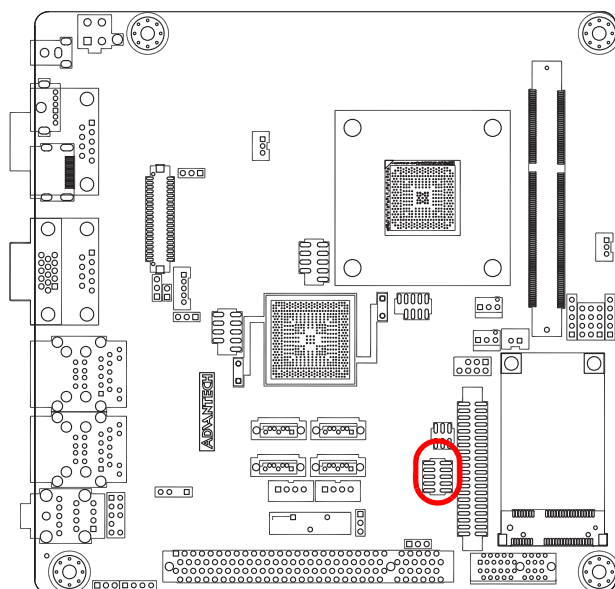

Chapter 3

BIOS Operation

3.1 Introduction

AMI BIOS has been integrated into many motherboards, and has been very popular for over a decade. People sometimes refer to the AMI BIOS setup menu as BIOS, BIOS setup or CMOS setup.

With the AMI BIOS Setup program, you can modify BIOS settings and control the special features of your computer. The Setup program uses a number of menus for making changes and turning special features on or off. This chapter describes the basic navigation of the AIMB-223 setup screens.

3.2 BIOS Setup

The AIMB-223 Series system has AMI BIOS built in, with a CMOS SETUP utility that allows users to configure required settings or to activate certain system features.

The CMOS SETUP saves the configuration in the CMOS RAM of the motherboard. When the power is turned off, the battery on the board supplies the necessary power to preserve the CMOS RAM.

When the power is turned on, press the button during the BIOS POST (Power-On Self Test) to access the CMOS SETUP screen.

Control Keys

< ↑ >< ↓ >< ← >< → >	Move to select item
----------------------	---------------------

<Enter>	Select Item
---------	-------------

<Esc>	Main Menu - Quit and not save changes into CMOS Sub Menu - Exit current page and return to Main Menu
-------	---

<Page Up/+>	Increase the numeric value or make changes
-------------	--

<Page Down/->	Decrease the numeric value or make changes
---------------	--

<F1>	General help, for Setup Sub Menu
------	----------------------------------

<F2>	Item Help
------	-----------

<F5>	Load Previous Values
------	----------------------

<F7>	Load Setup Defaults
------	---------------------

<F10>	Save all CMOS changes
-------	-----------------------

3.2.1 Main Menu

Press to enter AMI BIOS CMOS Setup Utility, the Main Menu will appear on the screen. Use arrow keys to select among the items and press <Enter> to accept or enter the sub-menu.

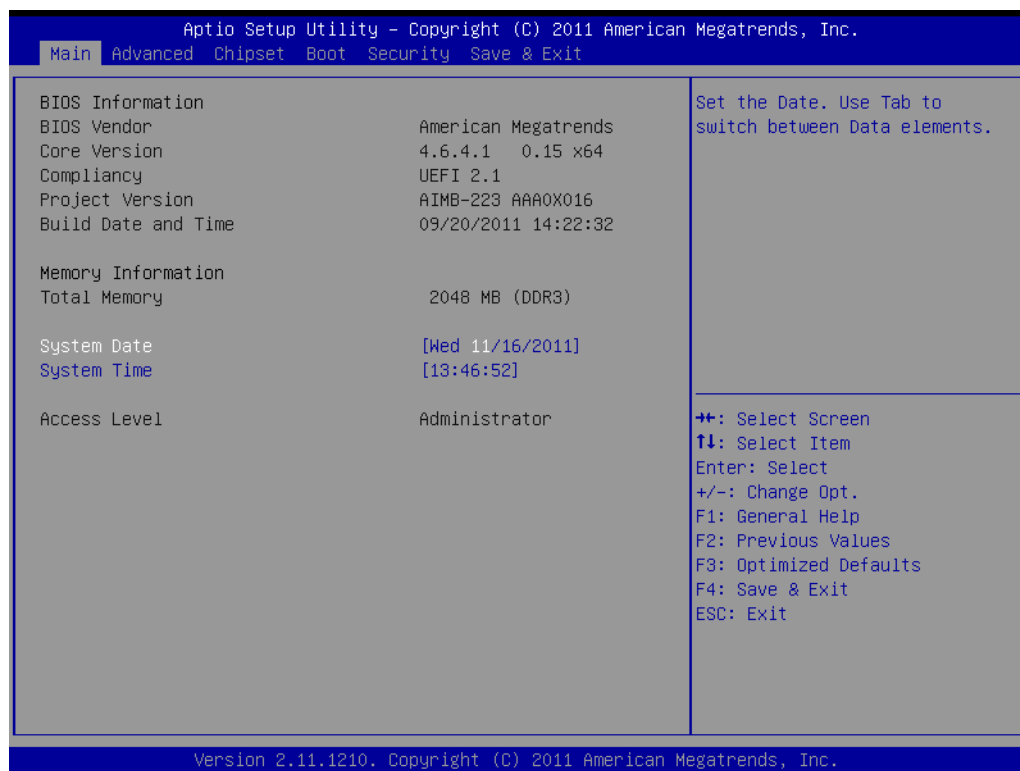

The Main BIOS setup screen has two main frames. The left frame displays all the options that can be configured. Grayed-out options cannot be configured; options in blue can. The right frame displays the key legend.

Above the key legend is an area reserved for a text message. When an option is selected in the left frame, it is highlighted in white. Often a text message will accompany it.

3.2.1.1 System time / System date

Use this option to change the system time and date. Highlight System Time or System Date using the <Arrow> keys. Enter new values through the keyboard. Press the <Tab> key or the <Arrow> keys to move between fields. The date must be entered in MM/DD/YY format. The time must be entered in HH:MM:SS format.

3.2.2 Advanced BIOS Features

Select the Advanced tab from the AIMB-223 setup screen to enter the Advanced BIOS Setup screen. You can select any of the items in the left frame of the screen, such as CPU Configuration, to go to the sub menu for that item. You can display an Advanced BIOS Setup option by highlighting it using the <Arrow> keys. All Advanced BIOS Setup options are described in this section. The Advanced BIOS Setup screen is shown below. The sub menus are described on the following pages.

You can also disable or enable the legacy OpROM for PXE / Storage.

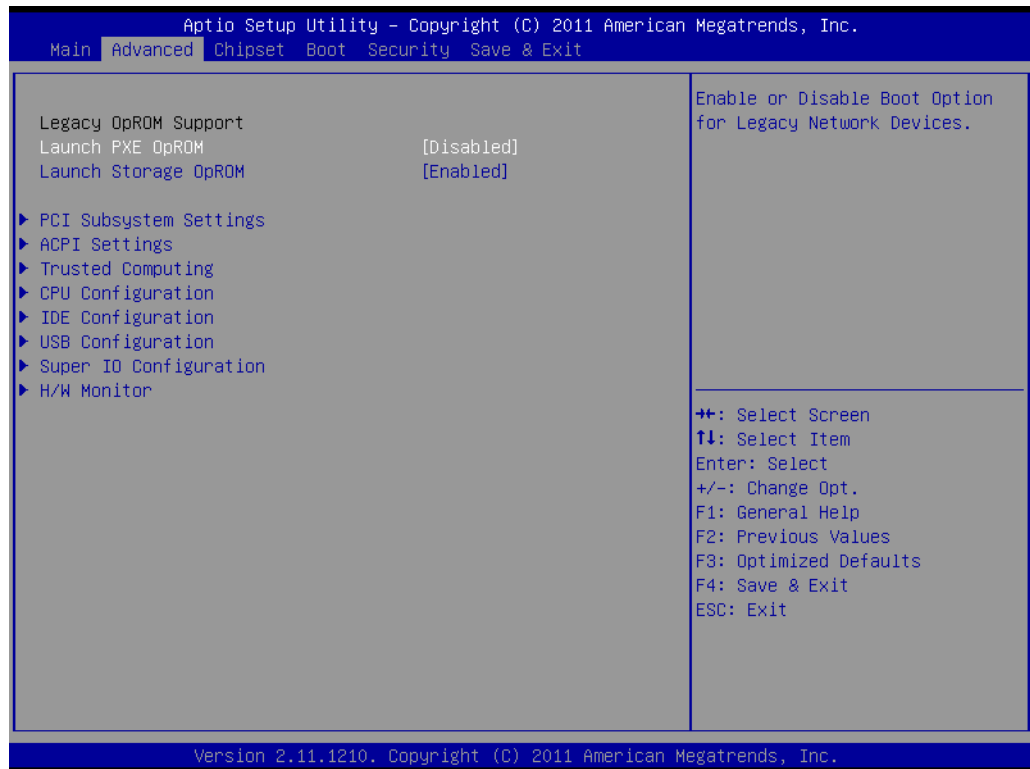

3.2.2.1 PCI Subsystem settings

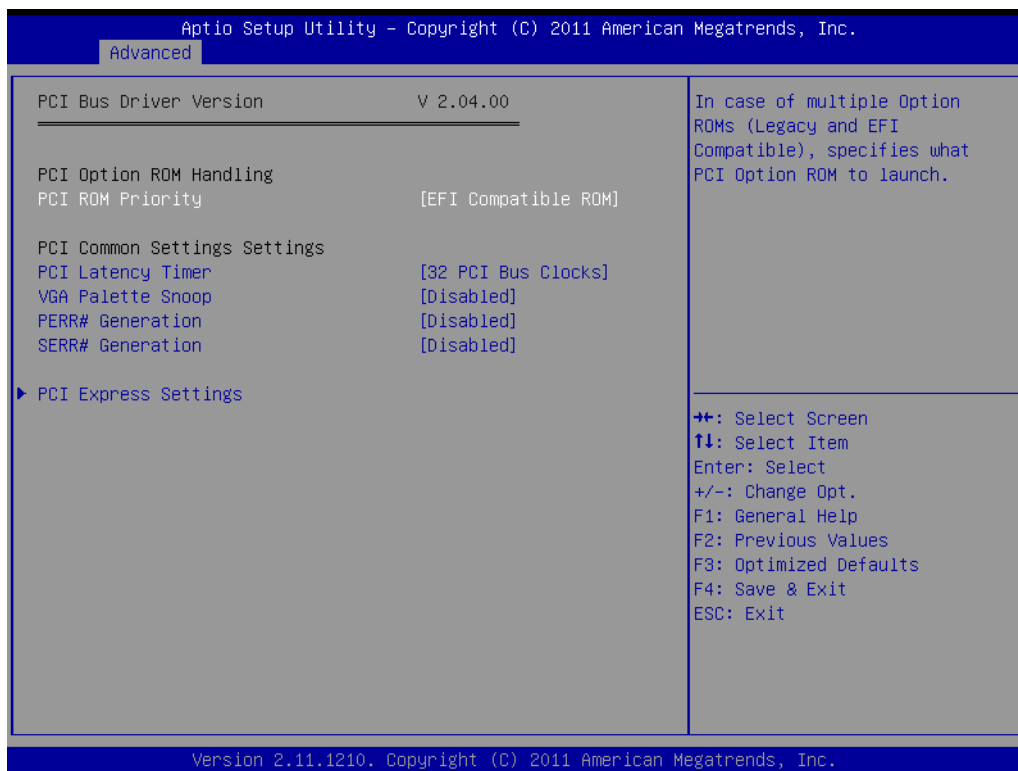

3.2.2.2 ACPI Setting

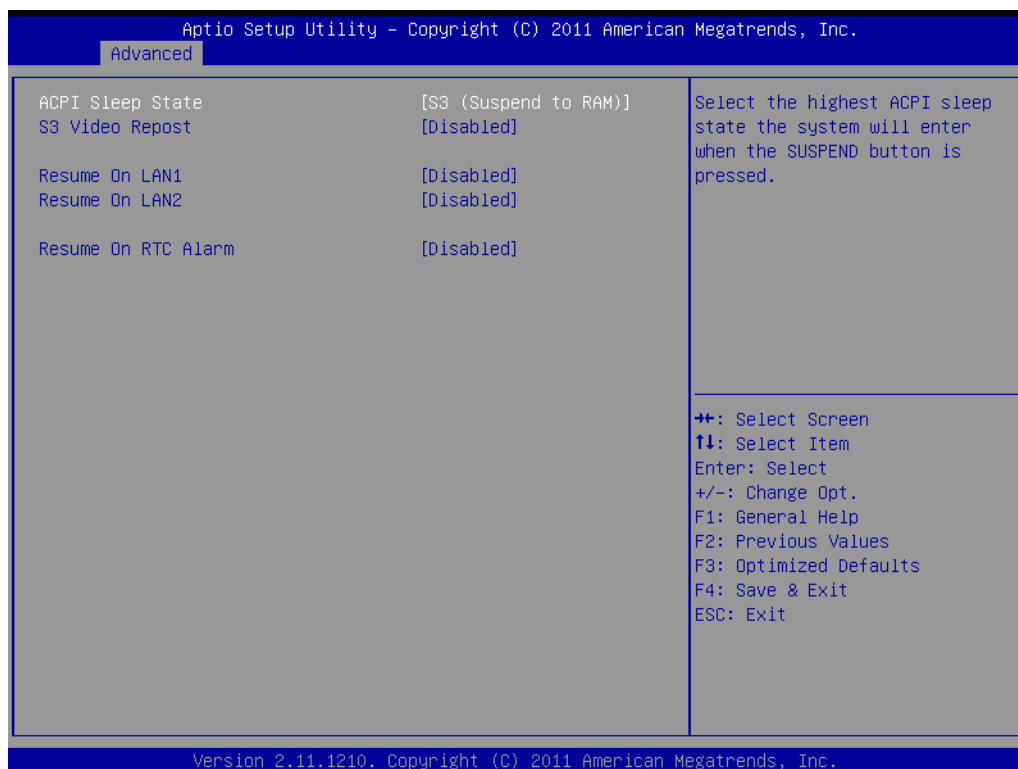

- **ACPI Sleep State**
Select the ACPI state used for system suspend.
- **S3 Report Video**
Enable or disable video repost.

- **Resume on LAN1**
Enables or disables GbE LAN1 wake up from S5 function.
- **Resume on LAN2**
Enables or disables GbE LAN2 wake up from S5 function.
- **Resume on RTC Alarm**
Disable/Enable RTC wake event.

3.2.2.3 Trusted Computing

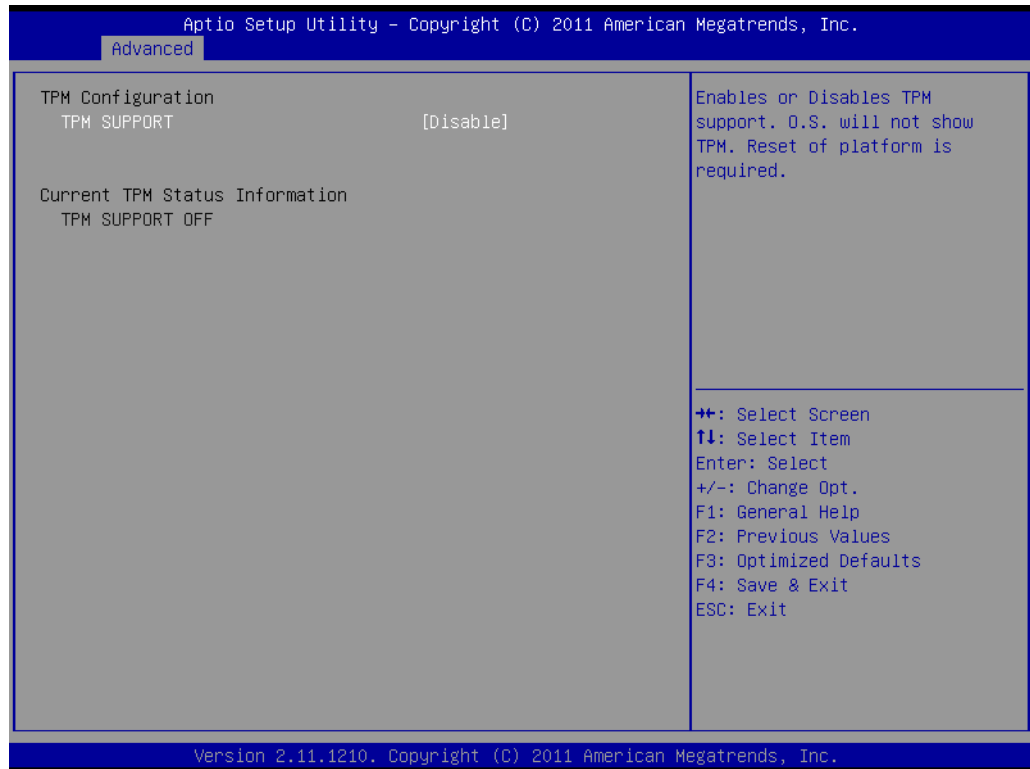

- **TPM SUPPORT**
Disable/Enable TPM function.

3.2.2.4 CPU configuration

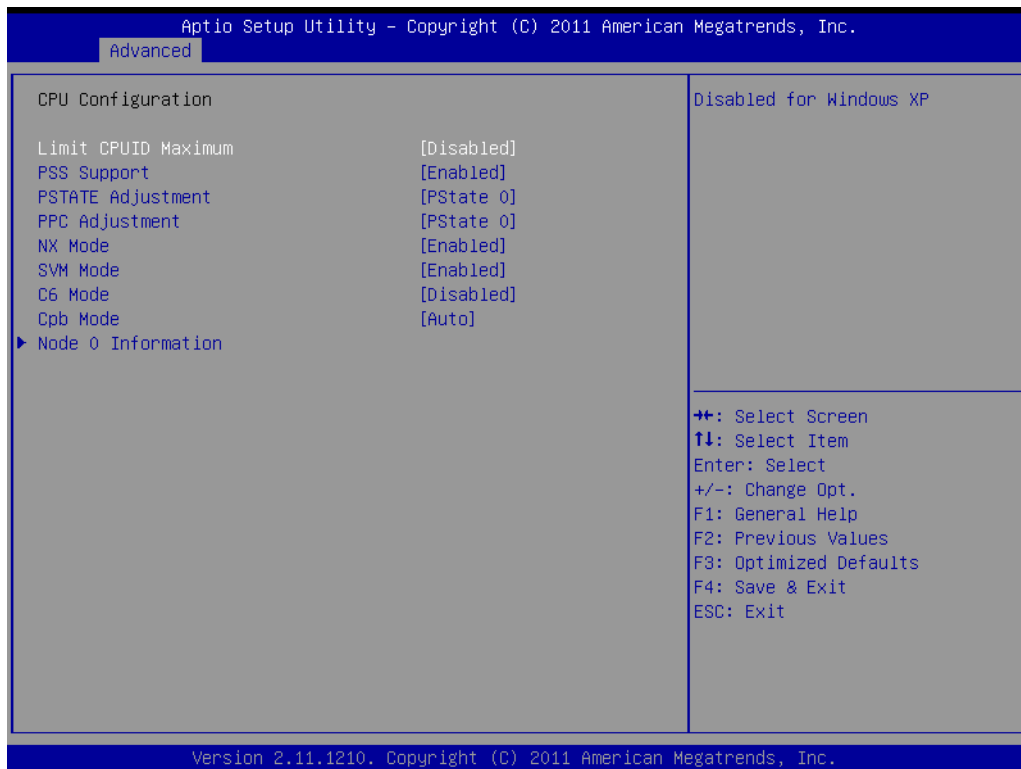

- **Limit CPUID Maximum**
This item allows you to limit CPUID maximum value.
- **PSS Support**
This item allows you to enable or disable the ACPI _PPC, _PSS, and _PCT objects.
- **PSTATE Adjustment**
This item allows you to provide P-state level.
- **PPC Adjustment**
This item allows you to provide _PPC object.
- **NX mode**
This item allows you to enable or disable the No-execute page protection function.
- **SVM mode**
This item allows you to enable or disable the CPU virtualization.
- **C6 mode**
This item allows you to auto or disable C6 function.
- **Cpb mode**
This item allows you to auto or disable CPB.

3.2.2.5 IDE configuration

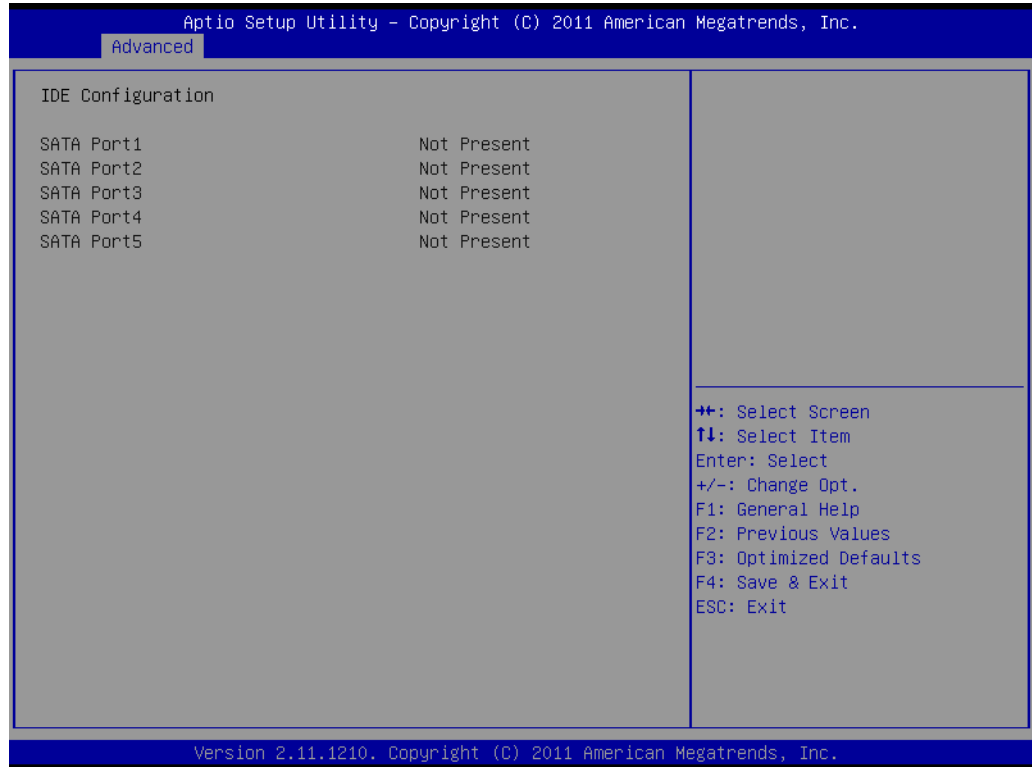

- **IDE Configuration**
Display SATA Port0 / SATA Port1 / SATA Port2 / SATA Port3 information.

3.2.2.6 USB configuration

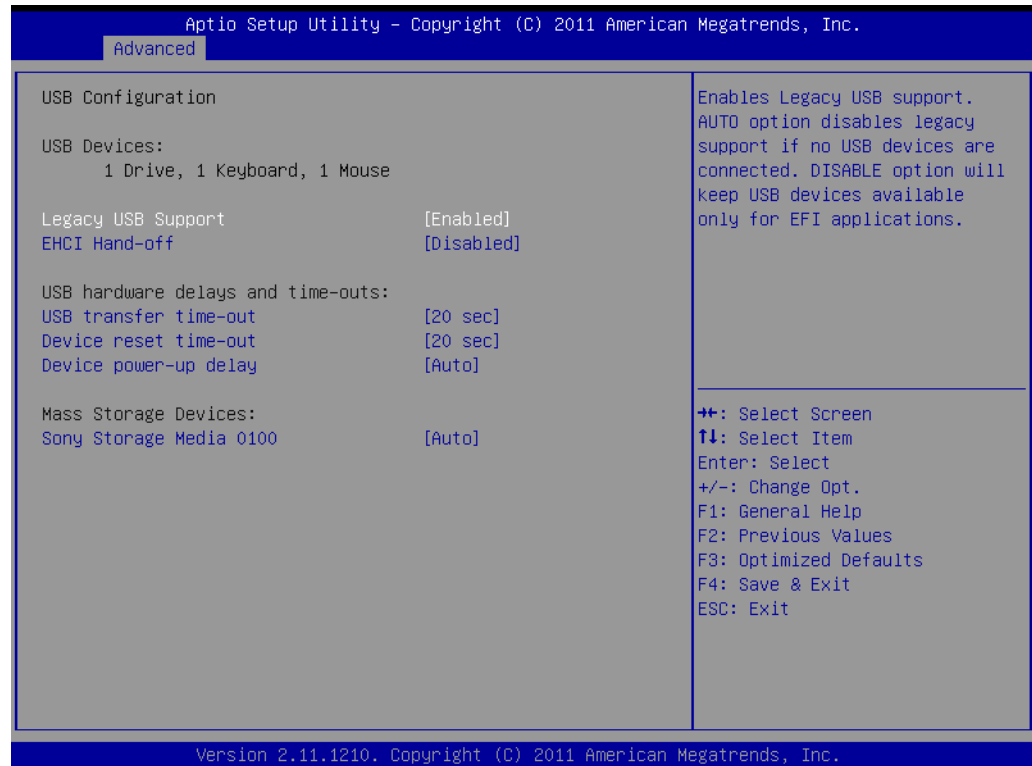

- **Legacy USB support**
Enables support for legacy USB. Auto option disables legacy support if no USB devices are connected.
- **EHCI Hand-off**
This is a workaround for OS without EHCI hand-off support. The EHCI ownership change should claim by EHCI driver.
- **USB transfer time-out**
Time-out value for control, bulk, and interrupt transfers.
- **Device reset time-out**
USB mass storage device starts unit command time-out.
- **Device power-up delay**
Maximum time the device will take before it properly report itself to the host controller.

3.2.2.7 Super configuration

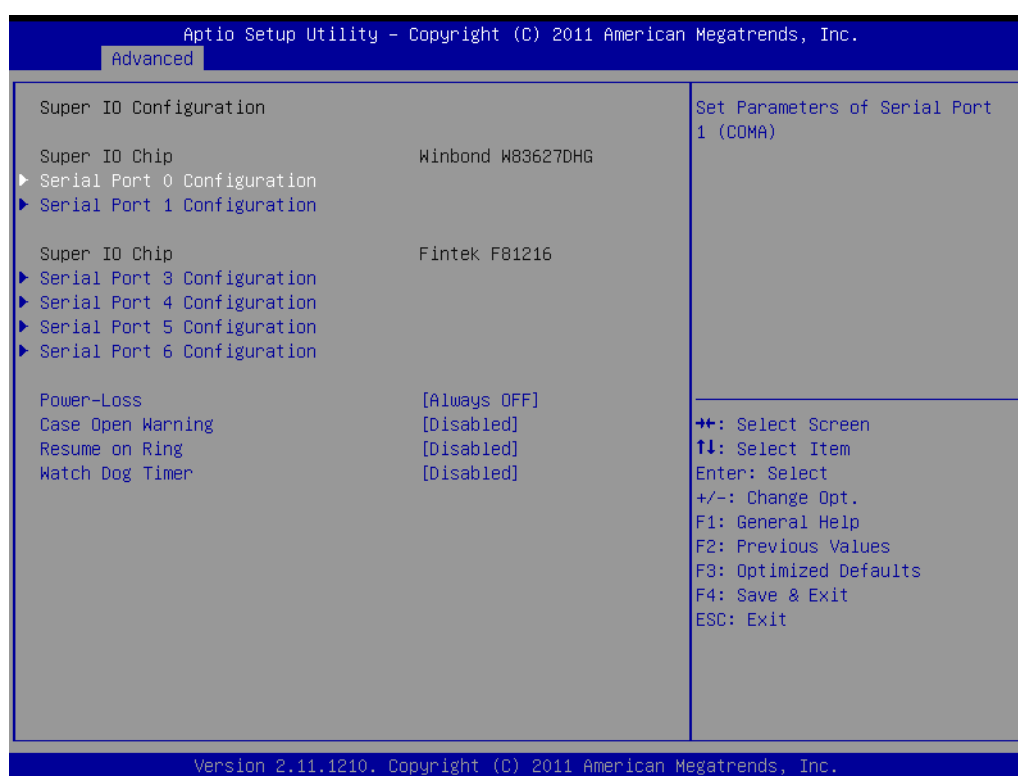

- **Case Open Warning**
This item will allow to enable/disable case open warning.
- **Resume on Ring**
Disable/Enable RI wake event.
- **Watch Dog Timer**
This item allows you to enable/disable the watchdog timer.

3.2.2.8 H/W monitor

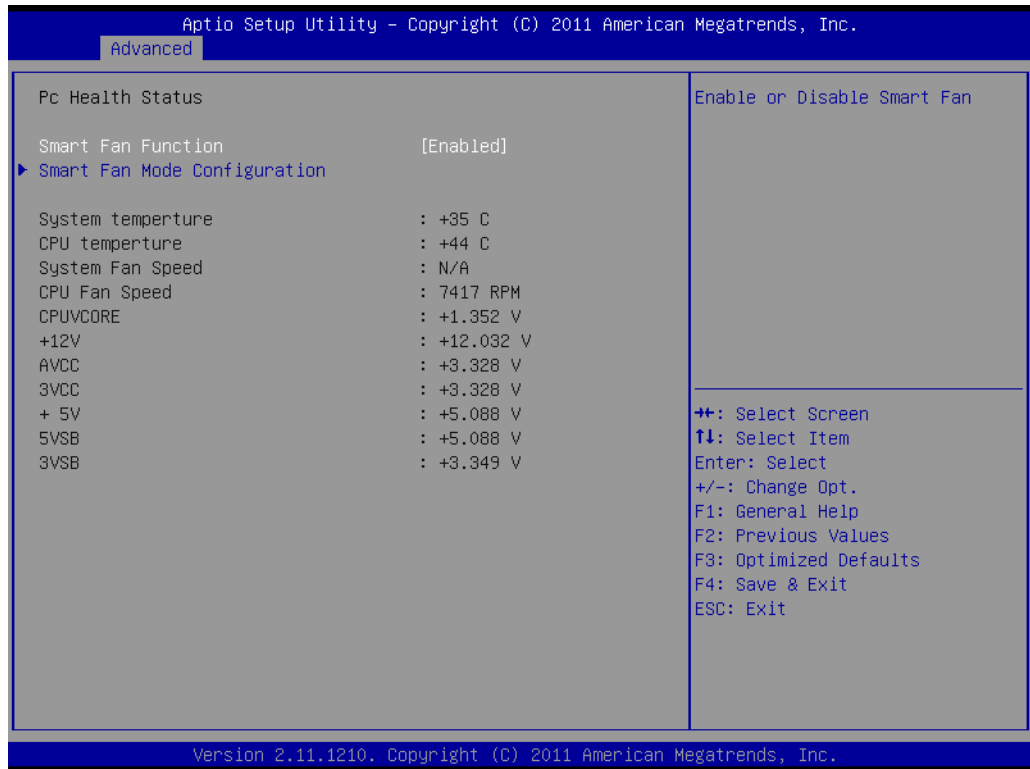

- **Smart Fan Function**
This item allows you to enable/disable CPU cooler smart function.

3.2.3 Chipset

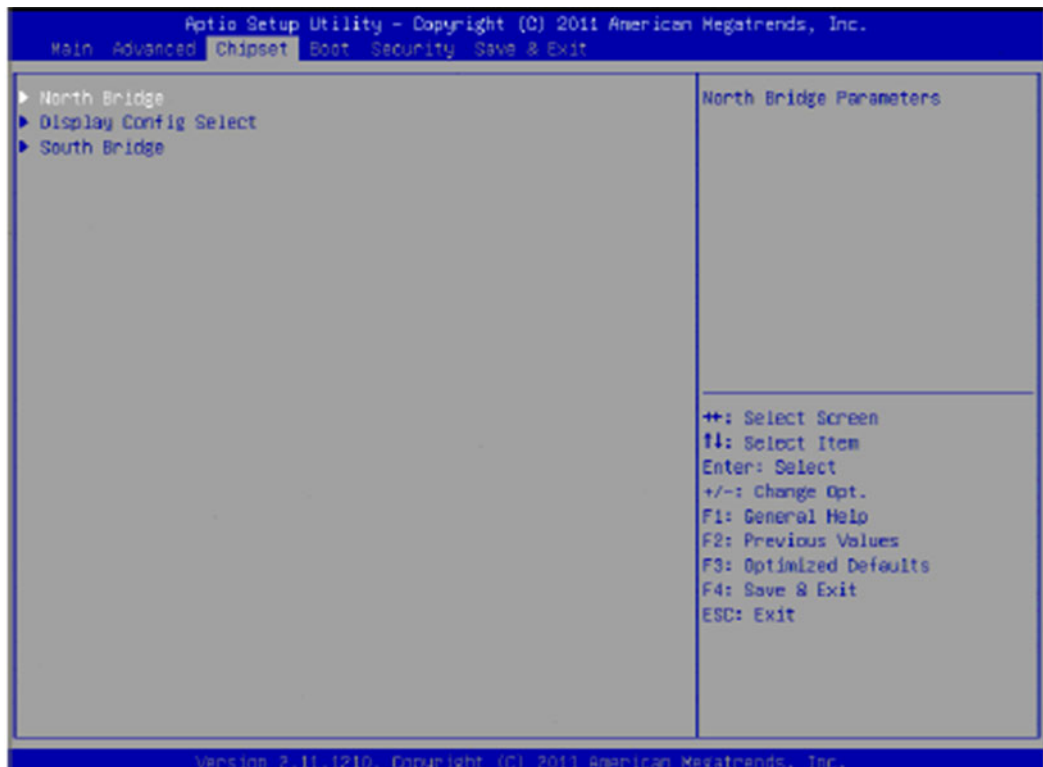

- **North Bridge Configuration**
Detail of North Bridge items.
- **Display Configuration Select**
Details of display items.
- **South Bridge Configuration**
Details of South bridge items.

3.2.3.1 North Bridge Configuration

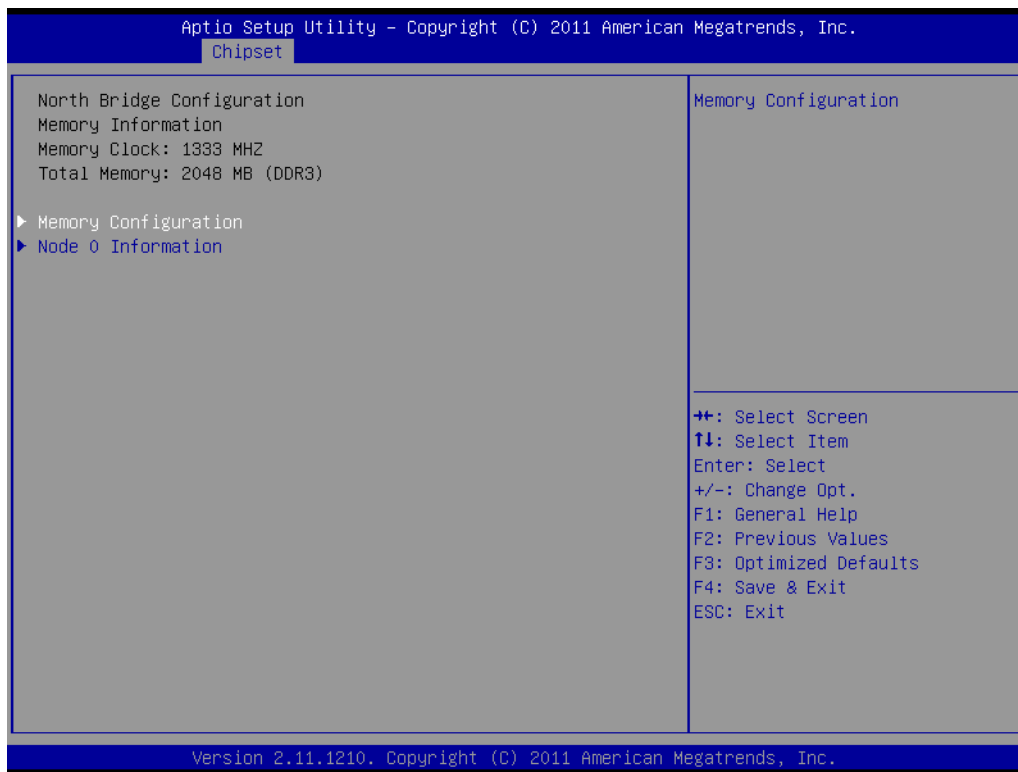

- **Memory Configuration**
Details of Bank Interleaving, IOMMU Mode, and Memory Clock items.
- **Node 0 Information**
Details of memory information.

3.2.3.2 Display Configuration

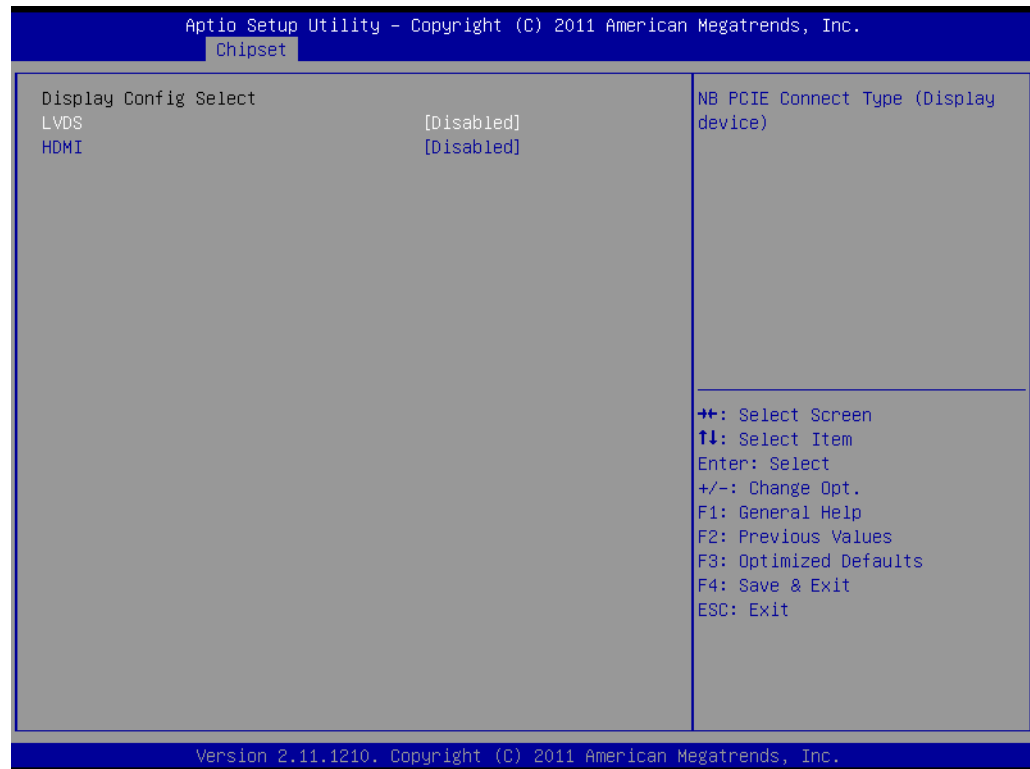

- **LVDS**
This item allows you to enable or disable LVDS function.
- **HDMI**
This item allows you to enable or disable HDMI function.

* LVDS setting of customized define, please refer to the document on CD-ROM:
"Chrontel EEPROM Adjust SOP

3.2.3.3 SB Configuration



- **SB SATA Configuration**
Options for SATA configuration.
- **SB USB Configuration**
Options for USB configuration.
- **SB GPP port Configuration**
Options for SB GPP port configuration.
- **SB HD Azalia Configuration**
Options for SB azalia.

3.2.4 Boot

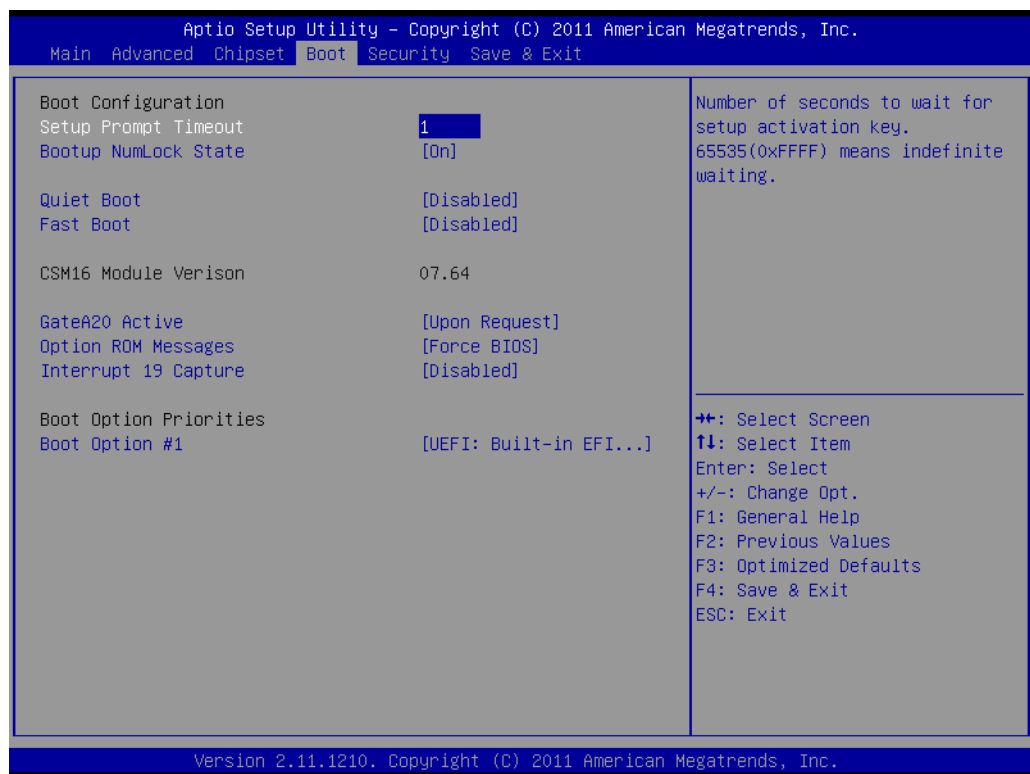

- **Setup Prompt Timeout**
This item allows you to change number of seconds to wait for setup activation key.
- **Bootup NumLock State**
Select the Power-on state for Numlock.
- **Quiet Boot**
If this option is set to Disabled, the BIOS display normal POST messages. If Enabled, an OEM Logo is shown instead of POST messages.
- **Fast Boot**
This item allows BIOS to skip certain tests while booting. This will decrease the time needed to boot the system.
- **GateA20 Active**
This item allows you to select upon request or Always.
- **Option ROM Messages**
Sets display mode for option ROM.
- **Interrupt 19 Capture**
This item allows option ROMs to trap interrupt 19.
- **Boot Option Priorities**
Set the system boot order.

3.2.5 Security



Select Security Setup from the AIMB-223 Setup main BIOS setup menu. All Security Setup options, such as password protection and virus protection are described in this section. To access the sub menu for the following items, select the item and press<Enter>: Change Administrator / User Password.

3.2.6 Save & Exit

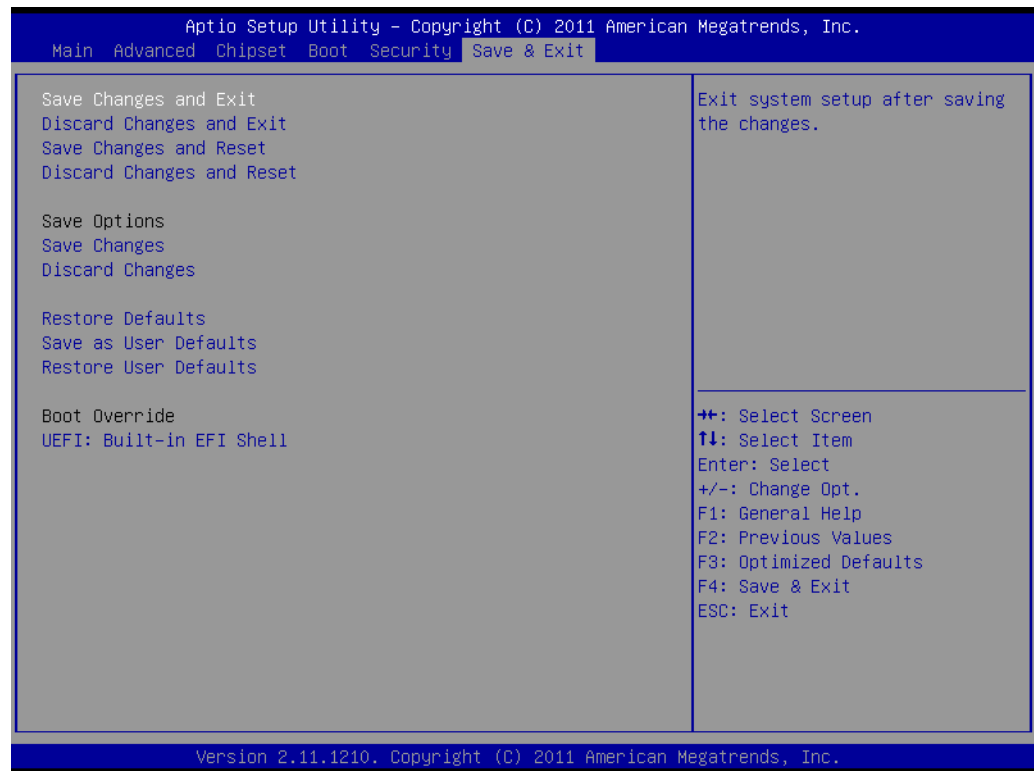

- **Save Changes and Exit**
This item allows you to exit system setup after saving changes.
- **Discard Changes and Exit**
This item allows you to exit system setup without saving any changes.
- **Save Changes and Reset**
This item allows you to reset the system after saving the changes.
- **Discard Changes and Reset**
This item allows you to rest system setup without saving any changes.
- **Save Changes**
This item allows you to save changes done so far to any of the options.
- **Discard Changes**
This item allows you to discard changes done so far to any of the options.
- **Restore Defaults**
This item allows you to restore/load default values for all the options.
- **Save as User Defaults**
This item allows you to save the changes done so far as user defaults.
- **Restore User Defaults**
This item allows you to restore the user defaults to all the options.
- **Boot Override**
Boot device select can override your boot priority.

Chapter 4

Software Introduction
& Service

4.1 Introduction

The mission of Advantech Embedded Software Services is to "Enhance quality of life with Advantech platforms and Microsoft® Windows® embedded technology." We enable Windows® Embedded software products on Advantech platforms to more effectively support the embedded computing community. Customers are freed from the hassle of dealing with multiple vendors (hardware suppliers, system integrators, embedded OS distributors) for projects. Our goal is to make Windows® Embedded Software solutions easily and widely available to the embedded computing community.

4.2 Value-Added Software Services

Software API: An interface that defines the ways by which an application program may request services from libraries and/or operating systems. Provides not only the underlying drivers required but also a rich set of user-friendly, intelligent and integrated interfaces, which speeds development, enhances security and offers add-on value for Advantech platforms. It plays the role of catalyst between developer and solution, and makes Advantech embedded platforms easier and simpler to adopt and operate with customer applications.

4.2.1 Software API

4.2.1.1 Control

GPIO



General Purpose Input/Output is a flexible parallel interface that allows a variety of custom connections. Allows users to monitor the level of signal input or set the output status to switch on/off the device. Our API also provide Programmable GPIO, which allows developers to dynamically set the GPIO input or output status.

SMBus



SMBus is the System Management Bus defined by Intel Corporation in 1995. It is used in personal computers and servers for low-speed system management communications. The SMBus API allows a developer to interface a embedded system environment and transfer serial messages using the SMBus protocols, allowing multiple simultaneous device control.

4.2.1.2 Display

Brightness Control



The Brightness Control API allows a developer to access embedded devices and easily control brightness.

Backlight



The Backlight API allows a developer to control the backlight (screen) on/off in embedded devices.

4.2.1.3 Monitor

Watchdog



A watchdog timer (WDT) is a device that performs a specific operation after a certain period of time if something goes wrong and the system does not recover on its own. A watchdog timer can be programmed to perform a warm boot (restarting the system) after a certain number of seconds.

Hardware Monitor



The Hardware Monitor (HWM) API is a system health supervision API that inspects certain condition indexes, such as fan speed, temperature and voltage.

4.2.1.4 Power Saving

CPU Speed



Makes use of Intel SpeedStep technology to save power consumption. The system will automatically adjust the CPU speed depending on the system loading.

System Throttling

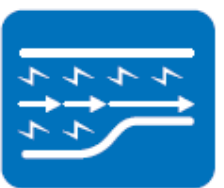

Refers to a series of methods for reducing power consumption in computers by lowering the clock frequency. This API allows the user to adjust the clock from 87.5% to 12.5%.

4.2.2 Software Utility

BIOS Flash

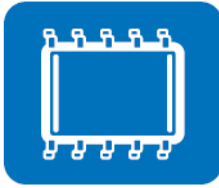

The BIOS Flash utility allows customers to update the flash ROM BIOS version, or use it to back up current BIOS by copying it from the flash chip to a file on customers' disk. The BIOS Flash utility also provides a command line version and an API for fast implementation into customized applications.

Embedded Security ID



The embedded application is the most important property of a system integrator. It contains valuable intellectual property, design knowledge and innovation, but it is easy to be copied! Embedded Security ID utility which provides reliable security functions for customers to secure their application data within embedded BIOS.

Monitoring



The Monitoring is a utility for customer to monitor the system health, like voltage, CPU and system temperature and fan speed. These items are important to a device, if the critical errors occur and are not solved immediately, permanent damage may be caused.

Flash Lock



Flash Lock is a mechanism to bind the Board and CF card (SQFlash) together. User can "Lock" SQFlash via Flash Lock function and "Unlock" by BIOS while booting. A locked SQFlash cannot be read by any card reader or boot from other platforms without a BIOS with "Unlock" feature.

eSOS



The eSOS is a small OS stored in BIOS ROM. It will boot up in case of a main OS crash. It will diagnose the hardware status, and then send an e-mail to the designated administrator. The eSOS also provide for remote connection via Telnet server and FTP server so the administrator can attempt to rescue the system. Note: This function requires BIOS customization.

Chapter 5

Chipset Software
Installation Utility

5.1 Before You Begin

To facilitate the installation of the enhanced display drivers and utility software, read the instructions in this chapter carefully. The drivers for the AIMB-223 are located on the software installation CD. The driver in the folder of the driver CD will guide and link you to the utilities and drivers under a Windows system. Updates are provided via Service Packs from Microsoft*.

Note! *The files on the software installation CD are compressed. Do not attempt to install the drivers by copying the files manually. You must use the supplied SETUP program to install the drivers.*



Before you begin, it is important to note that most display drivers need to have the relevant software application already installed in the system prior to installing the enhanced display drivers. In addition, many of the installation procedures assume that you are familiar with both the relevant software applications and operating system commands. Review the relevant operating system commands and the pertinent sections of your application software's user manual before performing the installation.

5.2 Introduction

The AMD Chipset Software Installation (CSI) utility installs the Windows INF files that outline to the operating system how the chipset components will be configured. This is needed for the proper functioning of the following features:

- Core PCI PnP services
- IDE Ultra ATA 100/66/33 and Serial ATA interface support
- USB 1.1/2.0 support (USB 2.0 driver needs to be installed separately for Win98)
- Identification of AMD chipset components in the Device Manager
- Integrates superior video features. These include filtered sealing of 720 pixel DVD content, and MPEG-2 motion compensation for software DVD

Note! *This utility is used for the following versions of Windows, and it has to be installed **before** installing all the other drivers:*



- Windows 7
- Windows XP

5.3 Windows XP Driver Setup

1. Insert the driver CD into your system's CD-ROM drive. You can see the driver folder items. Navigate to the "Chipset" folder and click "infinst_autol.exe" to complete the installation of the driver.

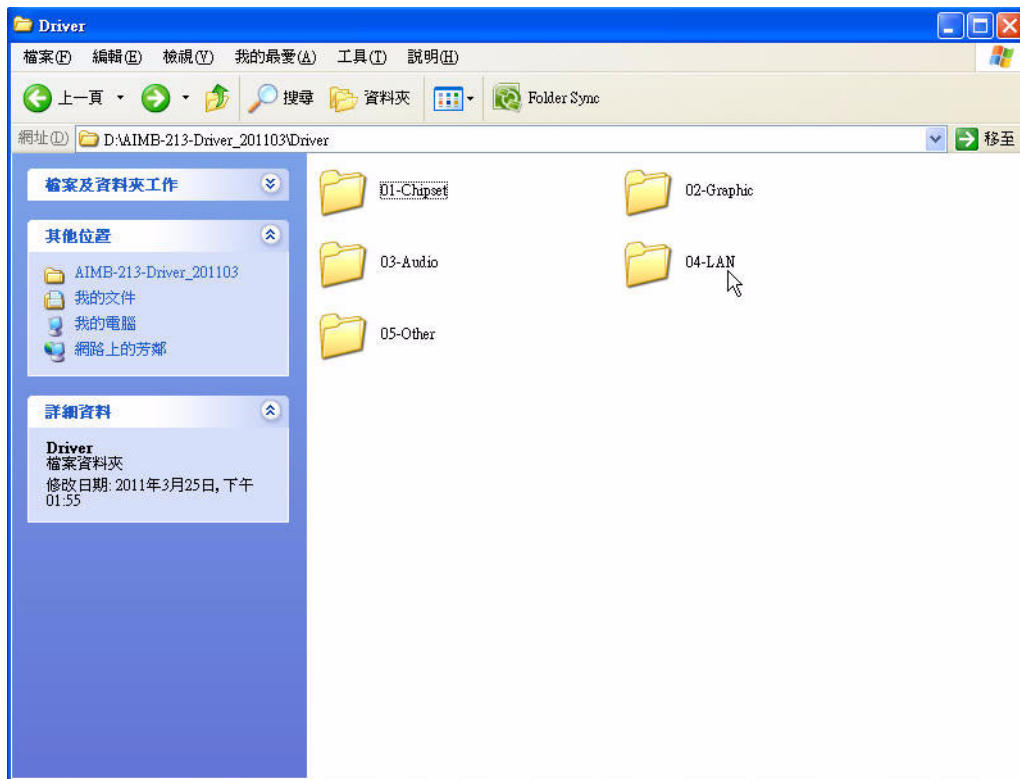

Chapter 6

VGA Setup

6.1 Introduction

To benefit from the AMD G-series T56N/T40E/T44R integrated graphics controller, you need to install the graphic driver.

6.2 Windows 7/XP

Note! Before installing this driver, make sure the CSI utility has been installed in your system. See Chapter 5 for information on installing the CSI utility.



Insert the driver CD into your system's CD-ROM drive. You can see the driver folders items. Navigate to the "Graphic" folder and click "setup.exe" to complete the installation of the drivers for Windows 7, Windows Vista, Windows XP.

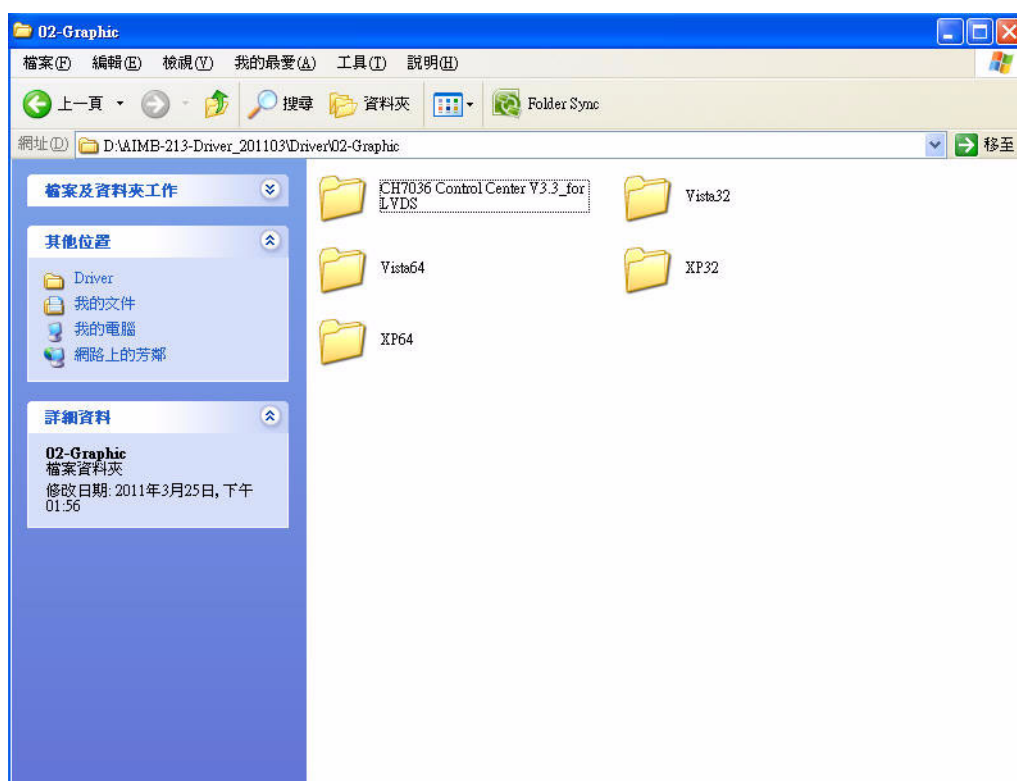

Chapter 7

LAN Configuration

7.1 Introduction

The AIMB-223 has dual Gigabit Ethernet LANs via dedicated PCI Express x1 lanes (Realtek RTL8111D for LAN1&2) that offer bandwidth of up to 500 MB/sec, eliminating the bottleneck of network data flow and incorporating Gigabit Ethernet at 1000 Mbps.

7.2 Features

- Integrated 10/100/1000 Mbps transceiver
- 10/100/1000 Mbps triple-speed MAC
- High-speed RISC core with 24-KB cache
- On-chip voltage regulation
- Wake-on-LAN (WOL) support
- PCI Express X1 host interface

7.3 Installation

Note! *Before installing the LAN drivers, make sure the CSI utility has been installed on your system. See Chapter 5 for information on installing the CSI utility.*



The AIMB-223's Realtek RTL8111D (LAN1&LAN2) Gigabit integrated controllers support all major network operating systems. However, the installation procedure varies from system to system. Please find and use the section that provides the driver setup procedure for the operating system you are using.

7.4 Windows 7/XP Driver Setup

Insert the driver CD into your system's CD-ROM drive. Select the LAN folder then navigate to the directory for your OS.

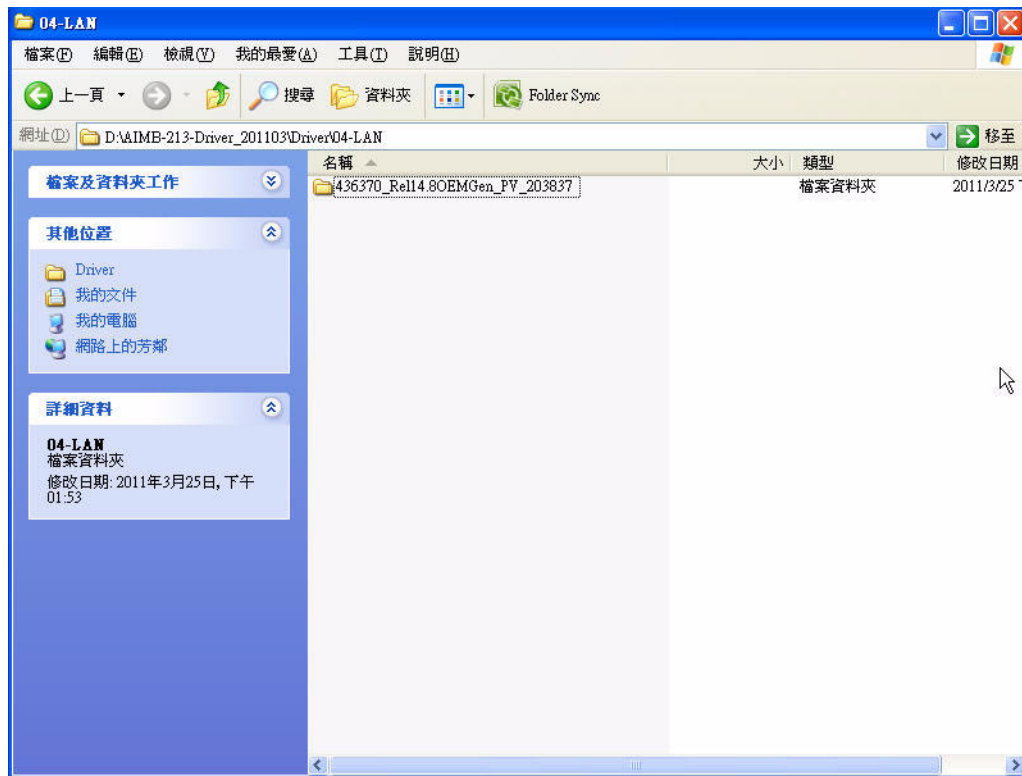

Appendix **A**

Programming the
Watchdog Timer

A.1 Programming the Watchdog Timer

The AIMB-223's watchdog timer can be used to monitor system software operation and take corrective action if the software fails to function within the programmed period. This section describes the operation of the watchdog timer and how to program it.

A.1.1 Watchdog Timer Overview

The watchdog timer is built into the super I/O controller W83627DHG-P. It provides the following user-programmable functions:

- Can be enabled and disabled by user program
- Timer can be set from 1 to 255 seconds or 1 to 255 minutes
- Generates an interrupt or resets signal if the software fails to reset the timer before time-out

A.1.2 Programming the Watchdog Timer

The I/O port address of the watchdog timer is 2E (hex) and 2F (hex). 2E (hex) is the address port. 2F (hex) is the data port. You must first assign the address of register by writing an address value into address port 2E (hex), then write/read data to/from the assigned register through data port 2F (hex).

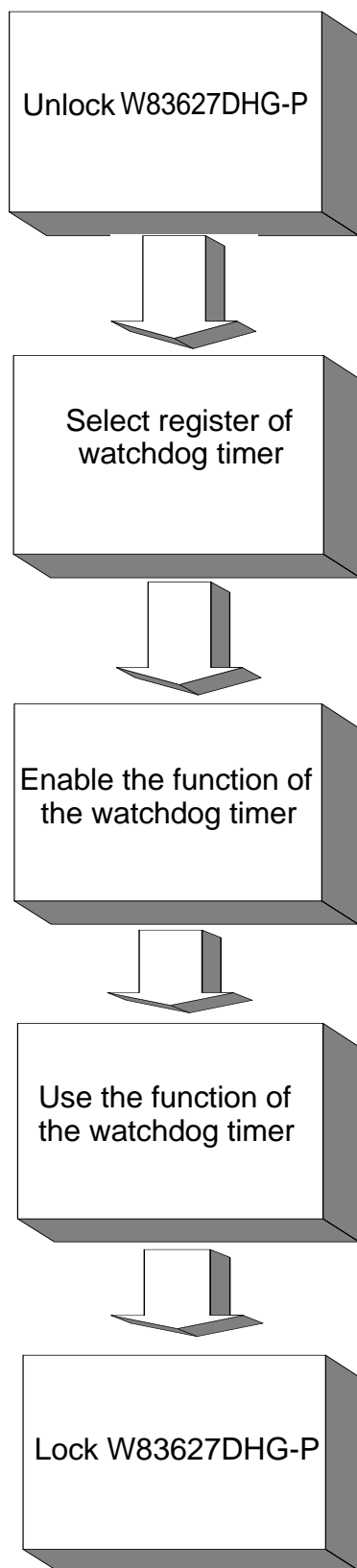

Table A.1: Watchdog Timer Registers

Address of Register (2E)	Attribute	
Read/Write	Value (2F) & description	
87 (hex)	-----	Write this address to I/O address port 2E (hex) twice to unlock the W83627DHG-P.
07 (hex)	write	Write 08 (hex) to select register of watchdog timer.
30 (hex)	write	Write 01 (hex) to enable the function of the watchdog timer. Disabled is set as default.
F5 (hex)	write	Set seconds or minutes as units for the timer. Write 0 to bit 3: set second as counting unit. [default] Write 1 to bit 3: set minutes as counting unit.
F6 (hex)	write	0: stop timer [default] 01~FF (hex): The amount of the count, in seconds or minutes, depends on the value set in register F5 (hex). This number decides how long the watchdog timer waits for strobe before generating an interrupt or reset signal. Writing a new value to this register can reset the timer to count with the new value.
F7 (hex)	read/write	Bit 7: Write 1 to enable mouse to reset the timer, 0 to disable [default]. Bit 6: Write 1 to enable keyboard to reset the timer, 0 to disable. [default] Bit 5: Write 1 to generate a timeout signal immediately and automatically return to 0. [default=0] Bit 4: Read status of watchdog timer, 1 means timer is "timeout".
AA (hex)	-----	Write this address to I/O port 2E (hex) to lock the watchdog timer 2.

A.1.3 Example Program

1. Enable watchdog timer and set 10 sec. as timeout interval

```

;-----
Mov dx,2eh ; Unlock W83627DHG-P
Mov al,87h
Out dx,al
Out dx,al
;-----
Mov al,07h ; Select registers of watchdog timer
Out dx,al
Inc dx
Mov al,08h
Out dx,al
;-----
Dec dx ; Enable the function of watchdog timer
Mov al,30h
Out dx,al
Inc dx
Mov al,01h
Out dx,al
;-----
Dec dx ; Set second as counting unit
Mov al,0f5h
Out dx,al
Inc dx
In al,dx
And al,not 08h
Out dx,al
;-----
Dec dx ; Set timeout interval as 10 seconds and start counting
Mov al,0f6h
Out dx,al
Inc dx
Mov al,10
Out dx,al
;-----
Dec dx ; Lock W83627DHG-P
Mov al,0aah
Out dx,al

```

2. Enable watchdog timer and set 5 minutes as timeout interval

```

;-----
Mov dx,2eh ; Unlock W83627DHG-P
Mov al,87h
Out dx,al
Out dx,al

```

```

;-----
Mov al,07h ; Select registers of watchdog timer
Out dx,al
Inc dx
Mov al,08h
Out dx,al
;-----
Dec dx ; Enable the function of watchdog timer
Mov al,30h
Out dx,al
Inc dx
Mov al,01h
Out dx,al
;-----
Dec dx ; Set minute as counting unit
Mov al,0f5h
Out dx,al
Inc dx
In al,dx
Or al,08h
Out dx,al
;-----
Dec dx ; Set timeout interval as 5 minutes and start counting
Mov al,0f6h
Out dx,al
Inc dx
Mov al,5
Out dx,al
;-----
Dec dx ; Lock W83627DHG-P
Mov al,0aah
Out dx,al
3. Enable watchdog timer to be reset by mouse
;-----
Mov dx,2eh ; Unlock W83627DHG-P
Mov al,87h
Out dx,al
Out dx,al
;-----
Mov al,07h ; Select registers of watchdog timer
Out dx,al
Inc dx
Mov al,08h
Out dx,al
;-----

```

```

Dec dx ; Enable the function of watchdog timer
Mov al,30h
Out dx,al
Inc dx
Mov al,01h
Out dx,al
;-----
Dec dx ; Enable watchdog timer to be reset by mouse
Mov al,0f7h
Out dx,al
Inc dx
In al,dx
Or al,80h
Out dx,al
;-----
Dec dx ; Lock W83627DHG-P
Mov al,0aah
Out dx,al
4. Enable watchdog timer to be reset by keyboard
;-----
Mov dx,2eh ; Unlock W83627DHG-P
Mov al,87h
Out dx,al
Out dx,al
;-----
Mov al,07h ; Select registers of watchdog timer
Out dx,al
Inc dx
Mov al,08h
Out dx,al
;-----
Dec dx ; Enable the function of watchdog timer
Mov al,30h
Out dx,al
Inc dx
Mov al,01h
Out dx,al
;-----
Dec dx ; Enable watchdog timer to be strobed reset by keyboard
Mov al,0f7h
Out dx,al
Inc dx
In al,dx
Or al,40h
Out dx,al

```

```

;-----
Dec dx ; Lock W83627DHG-P
Mov al,0aah
Out dx,al
5. Generate a time-out signal without timer counting
;-----
Mov dx,2eh ; Unlock W83627DHG-P
Mov al,87h
Out dx,al
Out dx,al
;-----
Mov al,07h ; Select registers of watchdog timer
Out dx,al
Inc dx
Mov al,08h
Out dx,al
;-----
Dec dx ; Enable the function of watchdog timer
Mov al,30h
Out dx,al
Inc dx
Mov al,01h
Out dx,al
;-----
Dec dx ; Generate a time-out signal
Mov al,0f7h
Out dx,al ;Write 1 to bit 5 of F7 register
Inc dx
In al,dx
Or al,20h
Out dx,al
;-----
Dec dx ; Lock W83627DHG-P
Mov al,0aah
Out dx,al

```

Appendix **B**

I/O Pin Assignments

B.1 USB Header (USB56, USB78)

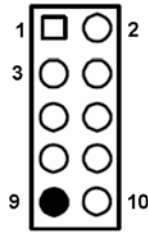

Table B.1: USB Header (USB56)

Pin	Signal	Pin	Signal
1	USB0_VCC5	2	USB1_VCC5
3	USB0_D-	4	USB1_D-
5	USB0_D+	6	USB1_D+
7	GND	8	GND
9	Key	10	GND

B.2 VGA Connector (VGA1)

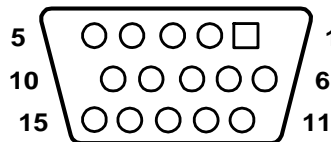

Table B.2: VGA Connector (VGA1)

Pin	Signal	Pin	Signal
1	RED	9	CRT_VCCIN
2	VGA_G	10	GND
3	VGA_B	11	N/C
4	N/C	12	V_SDAT
5	GND	13	H-SYNC
6	GND	14	V-SYNC
7	GND	15	V_SCLK

B.3 RS-232 Interface (COM3/4/5/6)

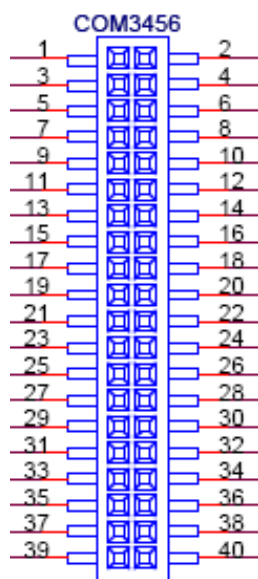

Table B.3: RS-232 Interface (COM3~COM6)

Pin	Signal	Pin	Signal
1	DCD_3	2	DSR_3
3	RXD_3	4	RTS_3
5	TXD_3	6	CTS_3
7	DTR_3	8	RRI_3
9	GND_3	10	GND_3
11	DCD_4	12	DSR_4
13	RXD_4	14	RTS_4
15	TXD_4	16	CTS_4
17	DTR_4	18	RRI_4
19	GND_4	20	GND_4
21	DCD_5	22	DSR_5
23	RXD_5	24	RTS_5
25	TXD_5	26	CTS_5
27	DTR_5	28	RRI_5
29	GND_5	30	GND_5
31	DCD_6	32	DSR_6
33	RXD_6	34	RTS_6
35	TXD_6	36	CTS_6
37	DTR_6	38	RRI_6
39	GND_6	40	GND_6

B.4 CN4: SPI Fresh Card Pin Connector

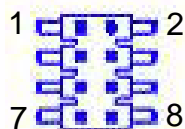

Table B.4: CN4: SPI Fresh Card Pin Connector

Pin	Signal	Pin	Signal
1	+F1_3V	2	GND
3	F1_SPI_CS#_Q	4	F1_SPI_CLK_Q
5	F1_SPI_MISO_Q	6	F1_SPI_MOSI_Q
7	NC	8	NC

B.5 CPU Fan Power Connector (CPU_FAN1)

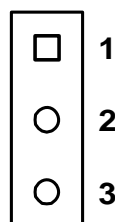

Table B.5: CPU Fan Power Connector (CPU_FAN1)

Pin	Signal
1	GND
2	+12 V
3	DETECT

B.6 System Fan Power Connector (SYS_FAN1)

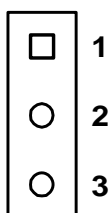

Table B.6: System Fan Power Connector (SYS_FAN1)

Pin	Signal
1	GND
2	+12VPWM
3	Sensor

B.7 Power LED & Keyboard Lock Connector (JFP3)

You can use an LED to indicate when the single board computer is on. Pin 1 of JFP3 supplies the LED's power, and Pin 3 is the ground.

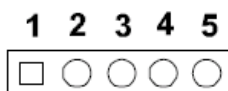

Table B.7: Power LED & Keyboard Lock Connector (JFP3)

Pin	Function
1	LED power
2	NC
3	GND
4	KEYLOCK#
5	GND

B.8 Power switch/HDD LED/SMBus/Speaker (JFP1+JFP2)

The single board computer has its own buzzer. You can also connect it to the external speaker on your computer chassis.

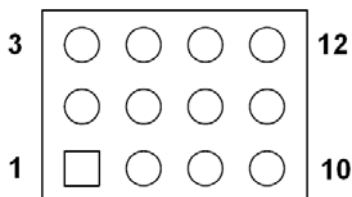

Table B.8: Power Switch/HDD LED/SMBus/Speaker (JFP1+JFP2)

Pin	Signal
1	+5 V
2	HDLED+
3	PWRBT
4	NC
5	HDLED-
6	PULL LOW
7	SPK_P3
8	I2C DATA
9	SYS_RST
10	SPK_P4
11	I2CCLK
12	GND

B.9 USB/LAN ports (LAN1_USB12/LAN2_USB34)

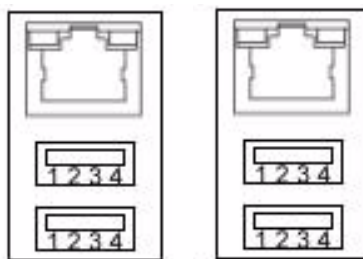

Table B.9: USB Port

Pin	Signal	Pin	Signal
1	VCC	3	Data0+
2	Data0-	4	GND

Table B.10: Ethernet 10/100 Mbps RJ-45 Port

Pin	Signal	Pin	Signal
1	XMT+	5	N/C
2	XMT-	6	RCV-
3	RCV+	7	N/C
4	N/C	8	N/C

B.10 Line In, Line Out, Mic In Connector (AUDIO1)

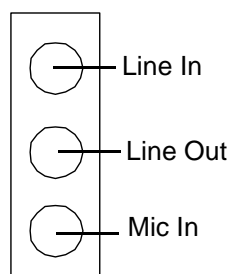

B.11 Serial ATA0/1 (SATA 1/2/3/4)

Table B.11: Serial ATA 0/1 (SATA 1/2/3/4)

Pin	Signal	Pin	Signal
1	GND	2	SATA_OTX+
3	SATA_OTX-	4	GND
5	SATA_ORX-	6	SATA_ORX+
7	GND	8	

B.12 AT/ATX Mode (PSON1)

Table B.12: AT/ATX Mode (PSON1)

Pin	Signal	Pin	Signal
1	VCCATX	2	VCCATX
3	GND		

B.13 GPIO Pin Header (GPIO1)

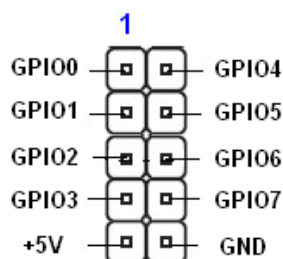

Table B.13: GPIO Pin Header (GPIO1)

Pin	Signal	Pin	Signal
1	GPI00	2	GPI04
3	GPI01	4	GPI05
5	GPI02	6	GPI06
7	GPI03	8	GPI07
9	+5V	10	GND

B.14 LVDS Connector: LVDS1

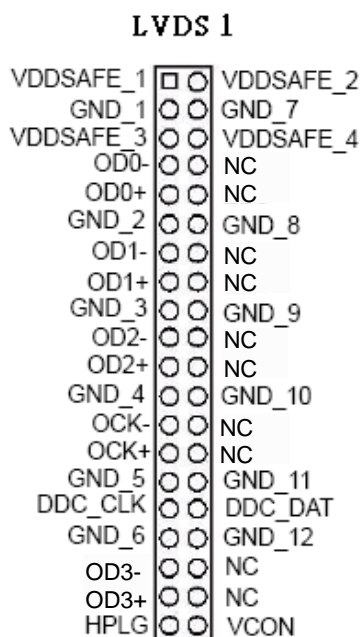



Table B.14: LVDS1 Connector

Pin	Signal	Pin	Signal
1	VDDSAFE_1	2	VDDSAFE_2
3	GND_1	4	GND_7
5	VDDSAFE_3	6	VDDSAFE_4
7	OD0-	8	NC
9	OD0+	10	NC
11	GND_2	12	GND_8
13	OD1-	14	NC
15	OD1+	16	NC
17	GND_3	18	GND_9
19	OD2-	20	NC
21	OD2+	22	NC
23	GND_4	24	GND_10
25	OCK-	26	NC
27	OCK+	28	NC
29	GND_3	30	GND_11
31	DDC_CLK	32	DDC_DAT
33	GND_6	34	GND_12
35	OD3-	36	NC
37	OD3+	38	NC
39	HPLG	40	VCON

B.15 LVDS Power Jumper (JBL3)

JBL3  for 3.3V LVDS panel

JBL3  for 5V LVDS panel

* default setting

Table B.15: LVDS Power Jumper

Pin	Signal
1	VCC3
2	VCC_LCD
3	VCC

B.16 LVDS Inverter (JBL1)

Table B.16: LVDS Power Jumper

Pin	Signal
1	+12V
2	GND
3	BL_EN
4	BL_CLT
5	+5V

B.17 ATX 12 V connector (ATX12V_1)



Table B.17: ATX 12 V connector (ATX12V_1)

Pin	Signal	Pin	Signal
1	GND	2	GND
3	+12V	4	+12V

ADVANTECH

Enabling an Intelligent Planet

www.advantech.com

Please verify specifications before quoting. This guide is intended for reference purposes only.

All product specifications are subject to change without notice.

No part of this publication may be reproduced in any form or by any means, electronic, photocopying, recording or otherwise, without prior written permission of the publisher.

All brand and product names are trademarks or registered trademarks of their respective companies.

© Advantech Co., Ltd. 2012