

REVISION HISTORY-- ALL SHEETS ARE THE SAME REVISION STATUS

REV A  
 SH 1 of 1  
 DWG NO RBC.0600

REV	DESCRIPTION	DATE	APPROVED
-----	-------------	------	----------

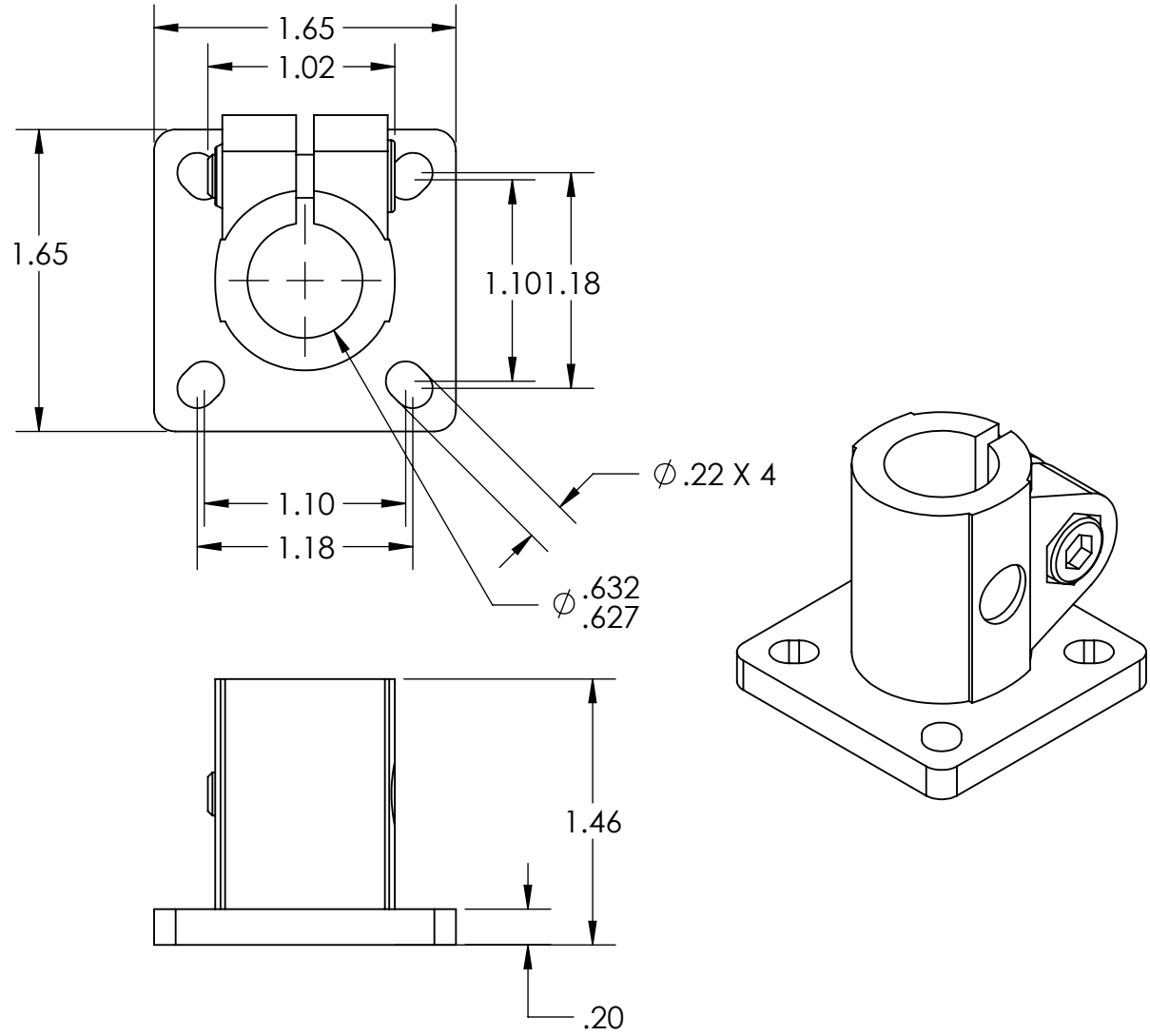

**CONFIDENTIAL**  
 © 2016 Phoenix Mecano Inc. This drawing is the property of Phoenix Mecano Inc. and embodies confidential information, trade secret information, and/or know-how which is the property of Phoenix Mecano Inc. By accepting this drawing, the recipient agrees not to provide, or otherwise make available, the drawing, or any information or know-how embodied therein, to any third party without prior written authorization.

UNLESS OTHERWISE SPECIFIED  
 DIM ARE IN INCHES  
 TOLERANCE:  
 ANGLE ± .5°  
 1 PL ± .030  
 2 PL ± .010  
 3 PL ± .005  
 INTERPRET DIM AND TOL PER  
 ASME Y14.5M-1994

THIRD ANGLE PROJECTION

DRAWN **Chi Pong**  
 APPROVED  
 APPROVED

Phoenix Mecano Inc.  
 7330 Executive Way  
 Frederick, MD 21704  
 (301) 696-9411 voice  
 (301) 696-9494 fax

TITLE  
**RK Clamp Catalog Drawing**

SIZE <b>A</b>	CAGE CODE <b>1L9R7</b>	DWG NO <b>RBC.0600</b>	REV <b>A</b>
SCALE <b>NTS</b>	DATE <b>7/14/2016</b>	SHEET <b>1 of 1</b>	