

**NOTES**

- ① 材料：TABLE 1 参照  
MATERIAL：SEE TABLE 1
- ② 製品仕様書、適合リセプタクルハウジングはSHEET 2を御参照下さい  
PLEASE REFER TO SHEET 2 FOR PRODUCT SPECIFICATION, APPLICABLE REC HOUSING.
- ③ 極数/2 = 偶数に適応  
APPLY FOR CIRCUIT SIZE / 2 =EVEN
- 4. 本製品のプラスチック部に黒点・白点等が確認される場合や色合いが異なる場合がありますが、製品性能に影響はありません。  
THERE IS NO INFLUENCE IN THE PRODUCT PERFORMANCE THOUGH THE BLACK AND WHITE SPOT ETC. MIGHT BE CONFIRMED TO THE PLASTIC PART OF THIS PRODUCT AND THE SHADE MIGHT BE DIFFERENT.
- ⑤ 発注番号：SHEET 2 参照  
ORDER No.：PLEASE REFER TO SHEET 2 FOR PRODUCT LIST.
- 6. 本製品はGlow Wire適合品です。  
THIS PRODUCT IS A GLOW WIRE COMPLIANT.

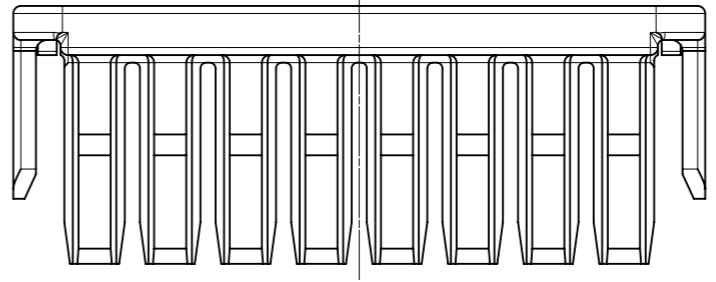
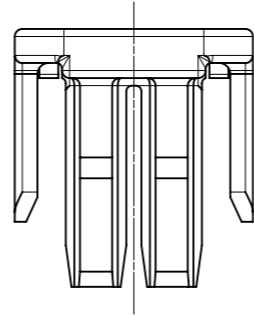
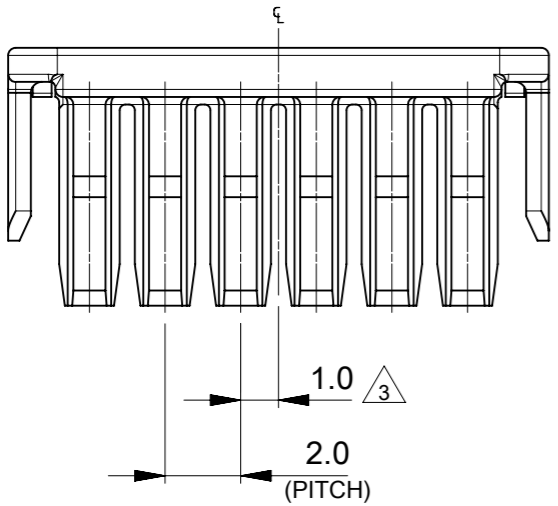
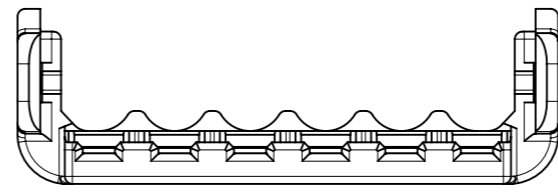
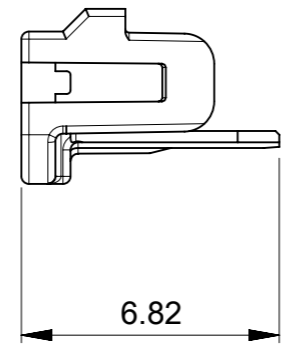
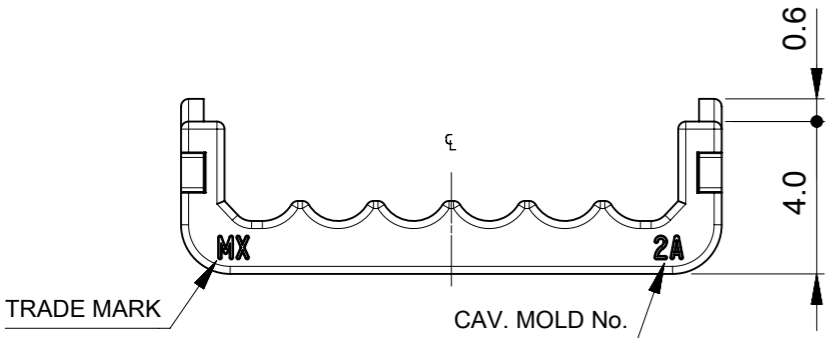
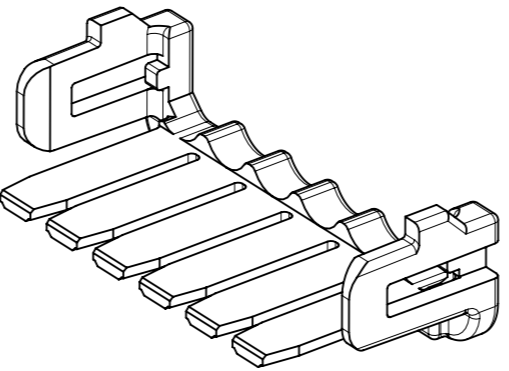
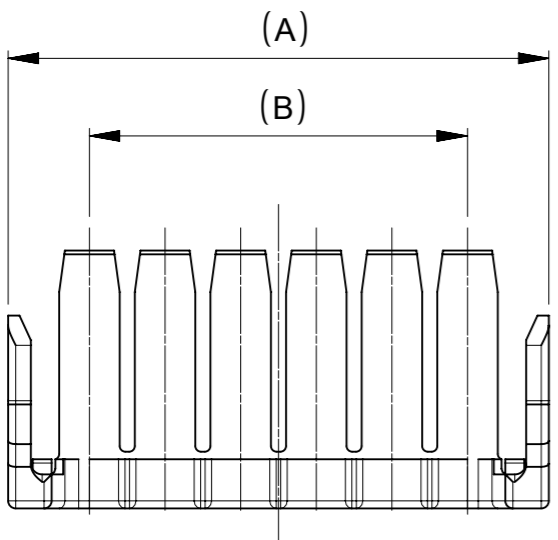

14	18.3	8
12	16.3	7
10	14.3	6
8	12.3	5
6	10.3	4
4	8.3	3
2	6.3	2
B	A	極数 CIRCUIT SIZE

① **TABLE**

部品 PART	材質 MATERIAL
ハウジング HOUSING	ポリアミド(PA),UL94V-0,色：灰色 POLYAMIDE(PA),UL94V-0,COLOR：GRAY
DOCUMENT STATUS	P1
RELEASE DATE	2021/10/06 08:18:47

THIS DRAWING CONTAINS INFORMATION THAT IS PROPRIETARY TO MOLEX ELECTRONIC TECHNOLOGIES, LLC AND SHOULD NOT BE USED WITHOUT WRITTEN PERMISSION

DIMENSION UNITS <b>mm</b>	SCALE <b>NTS</b>	CURRENT REV DESC:		<b>molex</b>			
GENERAL TOLERANCES (UNLESS SPECIFIED)		EC NO: 680154					MICRO-ONE 2.0W/B TPA RETAINER
ANGULAR TOL	± 3.0°	4 PLACES	± 0.2	DRWN: KYAMADA02	2021/10/05	PRODUCT CUSTOMER DRAWING	
3 PLACES	± 0.2	CHK'D: AIDA	2021/10/06	APPR: SAKIYAMA	2021/10/06		
2 PLACES	± 0.2	INITIAL REVISION:		DOCUMENT NUMBER			
1 PLACE	± 0.2	DRWN: KYAMADA02	2020/06/04	2127250000-SD			
0 PLACES	± 0.2	APPR: SAKIYAMA	2021/04/23	PSD 000 B			
DRAFT WHERE APPLICABLE MUST REMAIN WITHIN DIMENSIONS		THIRD ANGLE PROJECTION	DRAWING	SERIES	MATERIAL NUMBER	CUSTOMER	SHEET NUMBER
			A3-SIZE	212725	SEE TABLE	GENERAL	1 OF 2

△<sub>2</sub> 適応製品及び各種仕様書  
 APPLICABLE PRODUCTS AND VARIOUS SPECIFICATIONS

梱包仕様書 PACKING SPECIFICATION	PART NUMBER	SPECIFICATION NUMBER
	2127252***	2127259200-SPK 000

適合リセプタクルハウジング APPLICABLE RECEPTACLE HOUSING	212724****
製品仕様書 PRODUCT SPECIFICATION	2059790000-PS 000
アプリケーション仕様書 APPLICATION SPECIFICATION	2059790000-AS 000

リテーナー装着図は"リセプタクルハウジング図面 : 2127240000-SD 000" 参照のこと  
 ASSEMBLY VIEW : REFER TO "APPLICABLE RECEPTACLE HOUSING : 2127240000-SD 000"  
 PART DRAWING.

△<sub>5</sub> 製品一覧  
 PRODUCTS LIST

COLOR	
GRAY	
2127252080	8
↑ 2070	7
2060	6
2050	5
2040	4
↓ 2030	3
2127252020	2
発注番号 : ORDER No.	極数 CIRCUIT SIZE
梱包形態 : ポリ袋 PACKAGE : POLYBAG	

THIS DRAWING CONTAINS INFORMATION THAT IS PROPRIETARY TO MOLEX ELECTRONIC TECHNOLOGIES, LLC AND SHOULD NOT BE USED WITHOUT WRITTEN PERMISSION										
DIMENSION UNITS	SCALE	CURRENT REV DESC:			<b>molex</b>					
mm	NTS									
GENERAL TOLERANCES (UNLESS SPECIFIED)		EC NO: 680154			MICRO-ONE 2.0W/B TPA RETAINER					
ANGULAR TOL	± 3.0 °	DRWN: KYAMADA02 2021/10/05			PRODUCT CUSTOMER DRAWING					
4 PLACES	± 0.2	CHK'D: AIDA 2021/10/06			DOCUMENT NUMBER					
3 PLACES	± 0.2	APPR: SAKIYAMA 2021/10/06			2127250000-SD			DOC TYPE	DOC PART	REVISION
2 PLACES	± 0.2	INITIAL REVISION:			2020/06/04			PSD	000	B
1 PLACE	± 0.2	DRWN: KYAMADA02			2021/04/23					
0 PLACES	± 0.2	APPR: SAKIYAMA								
DRAFT WHERE APPLICABLE MUST REMAIN WITHIN DIMENSIONS	THIRD ANGLE PROJECTION	DRAWING	SERIES	MATERIAL NUMBER	CUSTOMER		SHEET NUMBER			
		A3-SIZE	212725	SEE TABLE	GENERAL		2 OF 2			

DOCUMENT STATUS	P1	RELEASE DATE	2021/10/06	08:18:47
-----------------	----	--------------	------------	----------