

**Data sheet | Item number: 2002-2214/1000-490**

Component terminal block; double-deck; with 2 diodes 1N4007; Top anode; for DIN-rail 35 x 15 and 35 x 7.5; 2.5 mm<sup>2</sup>; Push-in CAGE CLAMP®; 2,50 mm<sup>2</sup>; gray

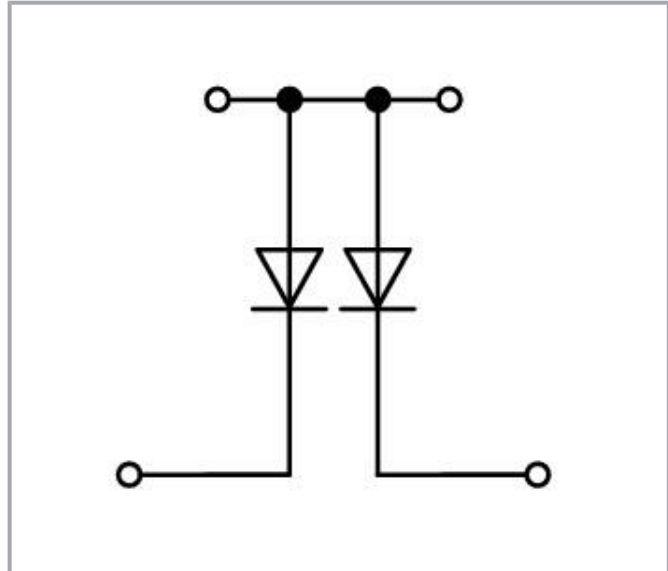

[www.wago.com/2002-2214/1000-490](http://www.wago.com/2002-2214/1000-490)

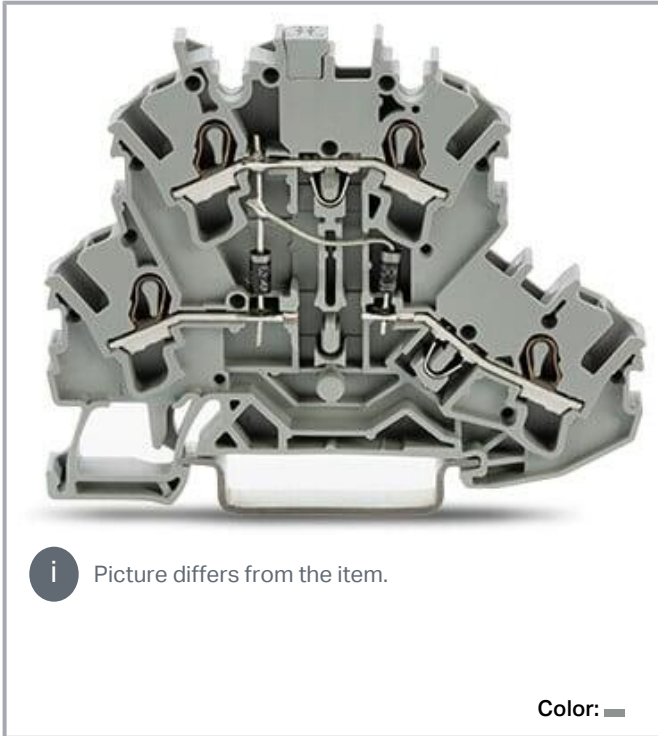

**Data**

**Electrical data**

**Ratings per IEC/EN**

|               |                  |
|---------------|------------------|
| Ratings per   | IEC/EN 60947-7-1 |
| Rated current | 0.5 A            |

**General**

|                 |         |
|-----------------|---------|
| Nominal voltage | 250 V   |
| Reverse voltage | 1,000 V |

**Connection data**

|                   |   |
|-------------------|---|
| Connection points | 4 |
|-------------------|---|

Subject to changes. Please also observe the further product documentation!

WAGO GmbH & Co. KG  
Hansastr. 27  
32423 Minden  
Phone: +49571 887-0 | Fax: +49571 887-169  
Email: [info.de@wago.com](mailto:info.de@wago.com) | Web: [www.wago.com](http://www.wago.com)

Do you have any questions about our products?  
We are always happy to take your call at +49 (571) 887-44222.



|                            |   |
|----------------------------|---|
| Total number of potentials | 3 |
| Number of levels           | 2 |

### Connection 1

|  |   |
|--|---|
| Connection technology                                      | Push-in CAGE CLAMP®   |
| Actuation type   | Operating tool  |
| Connectable conductor materials                            | Copper  |
| Nominal cross-section                                      | 2.5 mm <sup>2</sup>   |
| Solid conductor  | 0.25 ... 4 mm <sup>2</sup> / 22 ... 12 AWG  |
| Solid conductor; push-in termination                       | 0.75 ... 4 mm <sup>2</sup> / 18 ... 12 AWG  |
| Fine-stranded conductor                                    | 0.25 ... 4 mm <sup>2</sup> / 22 ... 12 AWG  |
| Fine-stranded conductor; with insulated ferrule            | 0.25 ... 2.5 mm <sup>2</sup> / 22 ... 14 AWG  |
| Fine-stranded conductor; with ferrule; push-in termination | 1 ... 2.5 mm <sup>2</sup> / 18 ... 14 AWG   |
| Note (conductor cross-section)                             | Depending on the conductor characteristic, a conductor with a smaller cross-section can also be inserted via push-in termination. |
| Strip length   | 10 ... 12 mm / 0.39 ... 0.47 inches   |
| Wiring direction   | Front-entry wiring  |

### Physical data

|                                   |                        |
|-----------------------------------|------------------------|
| Width                             | 5.2 mm / 0.205 inches  |
| Height                            | 69.7 mm / 2.744 inches |
| Depth from upper-edge of DIN-rail | 51.7 mm / 2.035 inches |

### Mechanical Data

|               |                     |
|---------------|---------------------|
| Mounting type | DIN-35 rail         |
| Marking level | Center/side marking |

### Material Data

|                             |  |
|-----------------------------|--|
| Note (material data)        | Information on material specifications can be found here |
| Color                       | gray   |
| Material group              | I  |
| Insulation material         | Polyamide (PA66)   |
| Flammability class per UL94 | V0   |
| Fire load                   | 0.237 MJ   |
| Weight                      | 10.5 g   |

Subject to changes. Please also observe the further product documentation!



## Environmental requirements

|                                  |                 |
|----------------------------------|-----------------|
| Processing temperature           | -35 ... +85 °C  |
| Continuous operating temperature | -60 ... +105 °C |

## Commercial data

|                       |               |
|-----------------------|---------------|
| Product Group         | 22 (TOPJOB S) |
| eCl@ss 10.0           | 27-14-11-27   |
| eCl@ss 9.0            | 27-14-11-27   |
| ETIM 8.0              | EC000903      |
| ETIM 7.0              | EC000903      |
| PU (SPU)              | 50 pcs        |
| Packaging type        | box           |
| Country of origin     | DE            |
| GTIN                  | 4045454375638 |
| Customs tariff number | 85369010000   |

## Environmental Product Compliance

|   |  |
|---|--|
| CAS-No.                                   | 7439-92-1<br>79-94-7                                     |
| REACH Candidate List Substance            | 2,2',6,6'-tetrabromo-4,4'-isopropylidenediphenol<br>Lead |
| RoHS Compliance Status                    | Compliant,With Exemption                                 |
| RoHS Exemption                            | 6(c)<br>7(a)<br>7(c)-I<br>7(c)-II                        |
| SCIP notification number (Austria)        | 8a24e930-ba31-49de-b434-6b4aa0f1954a                     |
| SCIP notification number (Belgium)        | 9af7f7f6-1f43-4d37-b18b-d1f0df9ceb9e                     |
| SCIP notification number (Bulgaria)       | 86182f28-b61f-4523-9466-448c2ba8133c                     |
| SCIP notification number (Czech Republic) | 1250dc91-cb22-4254-8411-a81364cdaa36                     |
| SCIP notification number (Denmark)        | b063802c-fdbe-4bb6-9c65-ec1f38f2ebd9                     |
| SCIP notification number (Finland)        | aef937b7-7cd2-472a-a2c3-efbb1105105b                     |
| SCIP notification number (France)         | 57ac7d36-d43f-4930-98d1-f9a384b1418f                     |
| SCIP notification number (Germany)        | 143cc2c9-cad9-4a8f-a05f-33c76e0bf8e6                     |
| SCIP notification number (Hungary)        | 7512616e-3d13-437d-bf8c-cf5116d29b78                     |
| SCIP notification number (Italy)          | bc704cf9-107a-49e0-b59b-ca18ab698aec                     |
| SCIP notification number (Netherlands)    | d701887f-5bf2-4a46-9979-090a479780bd                     |

Subject to changes. Please also observe the further product documentation!

WAGO GmbH & Co. KG  
Hansastr. 27  
32423 Minden  
Phone: +49571 887-0 | Fax: +49571 887-169  
Email: [info.de@wago.com](mailto:info.de@wago.com) | Web: [www.wago.com](http://www.wago.com)

Do you have any questions about our products?  
We are always happy to take your call at +49 (571) 887-44222.

|                                    |                                      |
|------------------------------------|--------------------------------------|
| SCIP notification number (Poland)  | 91c9c749-989f-4d8f-8867-c353688a66e3 |
| SCIP notification number (Romania) | 44ece845-4edf-4e3c-9928-8722ad6d8647 |
| SCIP notification number (Sweden)  | 683ee5a2-0e33-417c-94d1-750d882e0d07 |

## Approvals / Certificates

### Declarations of conformity and manufacturer's declarations

| Logo   | Approval                             | Additional Approval Text | Certificate name |
|--|--------------------------------------|--------------------------|------------------|
|  | <b>Railway</b><br>WAGO GmbH & Co. KG | -                        | Railway Ready    |

## Required accessories

### End plate

#### End plate



**Item no.: 2002-2291**  
End and intermediate plate; 0.8 mm thick; gray

[www.wago.com/2002-2291](http://www.wago.com/2002-2291)



**Item no.: 2002-2292**  
End and intermediate plate; 0.8 mm thick; orange

[www.wago.com/2002-2292](http://www.wago.com/2002-2292)

## Optional accessories

### Carrier rail

#### Mounting accessories



**Item no.: 210-197**  
Steel carrier rail; 35 x 15 mm; 1.5 mm thick; 2 m long; slotted; similar to EN 60715; silver-colored

[www.wago.com/210-197](http://www.wago.com/210-197)



**Item no.: 210-198**  
Copper carrier rail; 35 x 15 mm; 2.3 mm thick; 2 m long; unslotted; according to EN 60715; copper-colored

[www.wago.com/210-198](http://www.wago.com/210-198)



**Item no.: 210-504**  
Steel carrier rail; 35 x 7.5 mm; 1 mm thick; 2 m long; slotted; galvanized; according to EN 60715; silver-colored

[www.wago.com/210-504](http://www.wago.com/210-504)



**Item no.: 210-505**  
Steel carrier rail; 35 x 7.5 mm; 1 mm thick; 2 m long; unslotted; galvanized; according to EN 60715; silver-colored

[www.wago.com/210-505](http://www.wago.com/210-505)

**Item no.: 210-506**

Subject to changes. Please also observe the further product documentation!

WAGO GmbH & Co. KG

Hansastr. 27













32423 Minden

Phone: +49571 887-0 | Fax: +49571 887-169

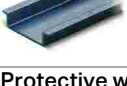
Email: [info.de@wago.com](mailto:info.de@wago.com) | Web: [www.wago.com](http://www.wago.com)





Do you have any questions about our products?

We are always happy to take your call at +49 (571) 887-44222.

|  |  |  |
|--|--|--|
|    | Steel carrier rail; 35 x 15 mm; 1.5 mm thick; 2 m long; unslotted; galvanized; similar to EN 60715; silver-colored   | <a href="http://www.wago.com/210-506">www.wago.com/210-506</a>   |
|    | <b>Item no.: 210-508</b><br>Steel carrier rail; 35 x 15 mm; 1.5 mm thick; 2 m long; slotted; galvanized; similar to EN 60715; silver-colored   | <a href="http://www.wago.com/210-508">www.wago.com/210-508</a>   |
|    | <b>Item no.: 210-113</b><br>Steel carrier rail; 35 x 7.5 mm; 1 mm thick; 2 m long; unslotted; according to EN 60715; silver-colored  | <a href="http://www.wago.com/210-113">www.wago.com/210-113</a>   |
|    | <b>Item no.: 210-118</b><br>Steel carrier rail; 35 x 15 mm; 2.3 mm thick; 2 m long; unslotted; according to EN 60715; silver-colored   | <a href="http://www.wago.com/210-118">www.wago.com/210-118</a>   |
|    | <b>Item no.: 210-112</b><br>Steel carrier rail; 35 x 7.5 mm; 1 mm thick; 2 m long; slotted; according to EN 60715; "Hole width 25 mm; silver-colored                                       | <a href="http://www.wago.com/210-112">www.wago.com/210-112</a>   |
|    | <b>Item no.: 210-114</b><br>Steel carrier rail; 35 x 15 mm; 1.5 mm thick; 2 m long; unslotted; similar to EN 60715; silver-colored   | <a href="http://www.wago.com/210-114">www.wago.com/210-114</a>   |
|    | <b>Item no.: 210-115</b><br>Steel carrier rail; 35 x 7.5 mm; 1 mm thick; 2 m long; slotted; according to EN 60715; "Hole width 18 mm; silver-colored                                       | <a href="http://www.wago.com/210-115">www.wago.com/210-115</a>   |
|   | <b>Item no.: 210-196</b><br>Aluminum carrier rail; 35 x 8.2 mm; 1.6 mm thick; 2 m long; unslotted; similar to EN 60715; silver-colored   | <a href="http://www.wago.com/210-196">www.wago.com/210-196</a>   |
| <b>Protective warning marker</b>   |  |  |
| Cover  |  |  |
|  | <b>Item no.: 2002-115</b><br>Protective warning marker; for 5 terminal blocks; with high-voltage symbol, black; yellow   | <a href="http://www.wago.com/2002-115">www.wago.com/2002-115</a> |
| <b>Ferrule</b>   |  |  |
| Ferrule  |  |  |
|   | <b>Item no.: 216-241</b><br>Ferrule; Sleeve for 0.5 mm <sup>2</sup> / 20 AWG; insulated; electro-tin plated; electrolytic copper; gastight crimped; acc. to DIN 46228, Part 4/09.90; white | <a href="http://www.wago.com/216-241">www.wago.com/216-241</a>   |
|   | <b>Item no.: 216-242</b><br>Ferrule; Sleeve for 0.75 mm <sup>2</sup> / 18 AWG; insulated; electro-tin plated; electrolytic copper; gastight crimped; acc. to DIN 46228, Part 4/09.90; gray | <a href="http://www.wago.com/216-242">www.wago.com/216-242</a>   |
|   | <b>Item no.: 216-243</b><br>Ferrule; Sleeve for 1 mm <sup>2</sup> / AWG 18; insulated; electro-tin plated; electrolytic copper; gastight crimped; acc. to DIN 46228, Part 4/09.90; red     | <a href="http://www.wago.com/216-243">www.wago.com/216-243</a>   |
|   | <b>Item no.: 216-244</b><br>Ferrule; Sleeve for 1.5 mm <sup>2</sup> / AWG 16; insulated; electro-tin plated; electrolytic copper; gastight crimped; acc. to DIN 46228, Part 4/09.90; black | <a href="http://www.wago.com/216-244">www.wago.com/216-244</a>   |
|   | <b>Item no.: 216-263</b><br>Ferrule; Sleeve for 1 mm <sup>2</sup> / AWG 18; insulated; electro-tin plated; electrolytic copper; gastight crimped;  | <a href="http://www.wago.com/216-263">www.wago.com/216-263</a>   |

Subject to changes. Please also observe the further product documentation!

acc. to DIN 46228, Part 4/09.90; red

|   |  |  |
|---|--|--|
|  | <b>Item no.: 216-246</b><br>Ferrule; Sleeve for 2.5 mm <sup>2</sup> / AWG 14; insulated; electro-tin plated; electrolytic copper; gastight crimped; acc. to DIN 46228, Part 4/09.90; blue  | <a href="http://www.wago.com/216-246">www.wago.com/216-246</a> |
|  | <b>Item no.: 216-266</b><br>Ferrule; Sleeve for 2.5 mm <sup>2</sup> / AWG 14; insulated; electro-tin plated; electrolytic copper; gastight crimped; acc. to DIN 46228, Part 4/09.90; blue  | <a href="http://www.wago.com/216-266">www.wago.com/216-266</a> |
|  | <b>Item no.: 216-264</b><br>Ferrule; Sleeve for 1.5 mm <sup>2</sup> / AWG 16; insulated; electro-tin plated; electrolytic copper; gastight crimped; acc. to DIN 46228, Part 4/09.90; black | <a href="http://www.wago.com/216-264">www.wago.com/216-264</a> |
|  | <b>Item no.: 216-262</b><br>Ferrule; Sleeve for 0.75 mm <sup>2</sup> / 18 AWG; insulated; electro-tin plated; electrolytic copper; gastight crimped; acc. to DIN 46228, Part 4/09.90; gray | <a href="http://www.wago.com/216-262">www.wago.com/216-262</a> |



### Push-in type wire jumper

Jumper

|  |  |  |
|--|--|--|
|    | <b>Item no.: 2009-412</b><br>Push-in type wire jumper; insulated; 60 mm long; black                                | <a href="http://www.wago.com/2009-412">www.wago.com/2009-412</a>                 |
|    | <b>Item no.: 2009-414</b><br>Push-in type wire jumper; 1.5 mm <sup>2</sup> ; insulated; 110 mm long; black         | <a href="http://www.wago.com/2009-414">www.wago.com/2009-414</a>                 |
|    | <b>Item no.: 2009-416</b><br>Push-in type wire jumper; 1.5 mm <sup>2</sup> ; insulated; 250 mm long; black         | <a href="http://www.wago.com/2009-416">www.wago.com/2009-416</a>                 |
|   | <b>Item no.: 2009-414/000-005</b><br>Push-in type wire jumper; 1.5 mm <sup>2</sup> ; insulated; 110 mm long; black | <a href="http://www.wago.com/2009-414/000-005">www.wago.com/2009-414/000-005</a> |
|  | <b>Item no.: 2009-414/000-006</b><br>Push-in type wire jumper; insulated; 110 mm long; black                       | <a href="http://www.wago.com/2009-414/000-006">www.wago.com/2009-414/000-006</a> |

### Tool

Operating tool

|  |   |  |
|--|---|--|
|  | <b>Item no.: 210-658</b><br>Operating tool; Blade: 3.5 x 0.5 mm; with a partially insulated shaft; angled; short; multicoloured | <a href="http://www.wago.com/210-658">www.wago.com/210-658</a> |
|  | <b>Item no.: 210-720</b><br>Operating tool; Blade: 3.5 x 0.5 mm; with a partially insulated shaft; multicoloured                | <a href="http://www.wago.com/210-720">www.wago.com/210-720</a> |













### Marking accessories

Marking strip













|  |  |  |
|--|--|--|
|  | <b>Item no.: 2009-110</b><br>Marking strips; for Smart Printer; on reel; not stretchable; plain; snap-on type; white | <a href="http://www.wago.com/2009-110">www.wago.com/2009-110</a> |
|--|--|--|

Marker carrier

Subject to changes. Please also observe the further product documentation!

|  |   |  |
|--|---|--|
|     | <b>Item no.: 2009-198</b><br>Adaptor; gray  | <a href="http://www.wago.com/2009-198">www.wago.com/2009-198</a>                 |
|    | <b>Item no.: 2002-121</b><br>Adaptor; gray  | <a href="http://www.wago.com/2002-121">www.wago.com/2002-121</a>                 |
|     | <b>Item no.: 2002-161</b><br>Adaptor; gray  | <a href="http://www.wago.com/2002-161">www.wago.com/2002-161</a>                 |
| <b>Marker</b>  |   |  |
|    | <b>Item no.: 2009-115/000-002</b><br>WMB-Inline; for Smart Printer; 1500 pieces on roll; stretchable 5 - 5.2 mm; plain; snap-on type; yellow      | <a href="http://www.wago.com/2009-115/000-002">www.wago.com/2009-115/000-002</a> |
|    | <b>Item no.: 2009-115/000-007</b><br>WMB-Inline; for Smart Printer; 1500 pieces on roll; stretchable 5 - 5.2 mm; plain; snap-on type; gray        | <a href="http://www.wago.com/2009-115/000-007">www.wago.com/2009-115/000-007</a> |
|    | <b>Item no.: 2009-115/000-017</b><br>WMB-Inline; for Smart Printer; 1500 pieces on roll; stretchable 5 - 5.2 mm; plain; snap-on type; light green | <a href="http://www.wago.com/2009-115/000-017">www.wago.com/2009-115/000-017</a> |
|   | <b>Item no.: 2009-115/000-023</b><br>WMB-Inline; for Smart Printer; 1500 pieces on roll; stretchable 5 - 5.2 mm; plain; snap-on type; green       | <a href="http://www.wago.com/2009-115/000-023">www.wago.com/2009-115/000-023</a> |
|  | <b>Item no.: 2009-115/000-024</b><br>WMB-Inline; for Smart Printer; 1500 pieces on roll; stretchable 5 - 5.2 mm; plain; snap-on type; violet      | <a href="http://www.wago.com/2009-115/000-024">www.wago.com/2009-115/000-024</a> |
|  | <b>Item no.: 2009-145/000-006</b><br>Mini-WSB Inline; for Smart Printer; 1700 pieces on roll; stretchable 5 - 5.2 mm; plain; snap-on type; blue   | <a href="http://www.wago.com/2009-145/000-006">www.wago.com/2009-145/000-006</a> |
|  | <b>Item no.: 2009-145</b><br>Mini-WSB Inline; for Smart Printer; 1700 pieces on roll; stretchable 5 - 5.2 mm; plain; snap-on type; white          | <a href="http://www.wago.com/2009-145">www.wago.com/2009-145</a>                 |
|  | <b>Item no.: 2009-145/000-002</b><br>Mini-WSB Inline; for Smart Printer; 1700 pieces on roll; stretchable 5 - 5.2 mm; plain; snap-on type; yellow | <a href="http://www.wago.com/2009-145/000-002">www.wago.com/2009-145/000-002</a> |
|  | <b>Item no.: 2009-145/000-007</b><br>Mini-WSB Inline; for Smart Printer; 1700 pieces on roll; stretchable 5 - 5.2 mm; plain; snap-on type; gray   | <a href="http://www.wago.com/2009-145/000-007">www.wago.com/2009-145/000-007</a> |
|  | <b>Item no.: 2009-145/000-005</b><br>Mini-WSB Inline; for Smart Printer; 1700 pieces on roll; stretchable 5 - 5.2 mm; plain; snap-on type; red    | <a href="http://www.wago.com/2009-145/000-005">www.wago.com/2009-145/000-005</a> |

Subject to changes. Please also observe the further product documentation!

|  |   |  |
|--|---|--|
|    | <b>Item no.: 2009-145/000-012</b><br>Mini-WSB Inline; for Smart Printer; 1700 pieces on roll; stretchable 5 - 5.2 mm; plain; snap-on type; orange | <a href="http://www.wago.com/2009-145/000-012">www.wago.com/2009-145/000-012</a> |
|    | <b>Item no.: 2009-145/000-023</b><br>Mini-WSB Inline; for Smart Printer; 1700 pieces on roll; stretchable 5 - 5.2 mm; plain; snap-on type; green  | <a href="http://www.wago.com/2009-145/000-023">www.wago.com/2009-145/000-023</a> |
|    | <b>Item no.: 2009-145/000-024</b><br>Mini-WSB Inline; for Smart Printer; 1700 pieces on roll; stretchable 5 - 5.2 mm; plain; snap-on type; violet | <a href="http://www.wago.com/2009-145/000-024">www.wago.com/2009-145/000-024</a> |
|    | <b>Item no.: 2009-115</b><br>WMB-Inline; for Smart Printer; 1500 pieces on roll; stretchable 5 - 5.2 mm; plain; snap-on type; white               | <a href="http://www.wago.com/2009-115">www.wago.com/2009-115</a>                 |
|    | <b>Item no.: 248-501/000-006</b><br>Mini-WSB marking card; as card; not stretchable; plain; snap-on type; blue                                    | <a href="http://www.wago.com/248-501/000-006">www.wago.com/248-501/000-006</a>   |
|    | <b>Item no.: 248-501/000-007</b><br>Mini-WSB marking card; as card; not stretchable; plain; snap-on type; gray                                    | <a href="http://www.wago.com/248-501/000-007">www.wago.com/248-501/000-007</a>   |
|   | <b>Item no.: 248-501/000-002</b><br>Mini-WSB marking card; as card; not stretchable; plain; snap-on type; yellow                                  | <a href="http://www.wago.com/248-501/000-002">www.wago.com/248-501/000-002</a>   |
|  | <b>Item no.: 248-501/000-012</b><br>Mini-WSB marking card; as card; not stretchable; plain; snap-on type; orange                                  | <a href="http://www.wago.com/248-501/000-012">www.wago.com/248-501/000-012</a>   |
|  | <b>Item no.: 248-501</b><br>Mini-WSB marking card; as card; not stretchable; plain; snap-on type; white   | <a href="http://www.wago.com/248-501">www.wago.com/248-501</a>                   |
|  | <b>Item no.: 248-501/000-017</b><br>Mini-WSB marking card; as card; not stretchable; plain; snap-on type; light green                             | <a href="http://www.wago.com/248-501/000-017">www.wago.com/248-501/000-017</a>   |
|  | <b>Item no.: 248-501/000-005</b><br>Mini-WSB marking card; as card; not stretchable; plain; snap-on type; red                                     | <a href="http://www.wago.com/248-501/000-005">www.wago.com/248-501/000-005</a>   |
|  | <b>Item no.: 248-501/000-024</b><br>Mini-WSB marking card; as card; not stretchable; plain; snap-on type; violet                                  | <a href="http://www.wago.com/248-501/000-024">www.wago.com/248-501/000-024</a>   |

Subject to changes. Please also observe the further product documentation!





**Item no.:** 248-501/000-023

Mini-WSB marking card; as card; not stretchable; plain; snap-on type; green

[www.wago.com/248-501/000-023](http://www.wago.com/248-501/000-023)



**Item no.:** 793-5501/000-007

WMB marking card; as card; for terminal block width 5 - 17.5 mm; stretchable 5 - 5.2 mm; plain; snap-on type; gray

[www.wago.com/793-5501/000-007](http://www.wago.com/793-5501/000-007)



**Item no.:** 793-5501/000-012

WMB marking card; as card; for terminal block width 5 - 17.5 mm; stretchable 5 - 5.2 mm; plain; snap-on type; orange

[www.wago.com/793-5501/000-012](http://www.wago.com/793-5501/000-012)



**Item no.:** 793-5501/000-014

WMB marking card; as card; for terminal block width 5 - 17.5 mm; stretchable 5 - 5.2 mm; plain; snap-on type; brown

[www.wago.com/793-5501/000-014](http://www.wago.com/793-5501/000-014)

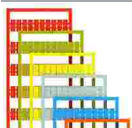

**Item no.:** 793-5501/000-017

WMB marking card; as card; for terminal block width 5 - 17.5 mm; stretchable 5 - 5.2 mm; plain; snap-on type; light green

[www.wago.com/793-5501/000-017](http://www.wago.com/793-5501/000-017)



**Item no.:** 793-5501/000-023

WMB marking card; as card; for terminal block width 5 - 17.5 mm; stretchable 5 - 5.2 mm; plain; snap-on type; green

[www.wago.com/793-5501/000-023](http://www.wago.com/793-5501/000-023)



**Item no.:** 793-5501/000-024

WMB marking card; as card; for terminal block width 5 - 17.5 mm; stretchable 5 - 5.2 mm; plain; snap-on type; violet

[www.wago.com/793-5501/000-024](http://www.wago.com/793-5501/000-024)

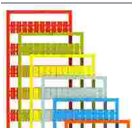

**Item no.:** 793-5501/000-005

WMB marking card; as card; for terminal block width 5 - 17.5 mm; stretchable 5 - 5.2 mm; plain; snap-on type; red

[www.wago.com/793-5501/000-005](http://www.wago.com/793-5501/000-005)

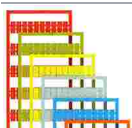

**Item no.:** 793-5501/000-002

WMB marking card; as card; for terminal block width 5 - 17.5 mm; stretchable 5 - 5.2 mm; plain; snap-on type; yellow

[www.wago.com/793-5501/000-002](http://www.wago.com/793-5501/000-002)

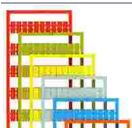

**Item no.:** 793-5501/000-006

WMB marking card; as card; for terminal block width 5 - 17.5 mm; stretchable 5 - 5.2 mm; plain; snap-on type; blue

[www.wago.com/793-5501/000-006](http://www.wago.com/793-5501/000-006)

















**Item no.:** 793-5501

WMB marking card; as card; for terminal block width 5 - 17.5 mm; stretchable 5 - 5.2 mm; plain; snap-on type; white

[www.wago.com/793-5501](http://www.wago.com/793-5501)

Subject to changes. Please also observe the further product documentation!

|   |  |  |
|---|--|--|
|  | <b>Item no.: 2009-115/000-012</b><br>WMB-Inline; for Smart Printer; 1500 pieces on roll; stretchable 5 - 5.2 mm; plain; snap-on type; orange | <a href="http://www.wago.com/2009-115/000-012">www.wago.com/2009-115/000-012</a> |
|  | <b>Item no.: 2009-115/000-006</b><br>WMB-Inline; for Smart Printer; 1500 pieces on roll; stretchable 5 - 5.2 mm; plain; snap-on type; blue   | <a href="http://www.wago.com/2009-115/000-006">www.wago.com/2009-115/000-006</a> |
|  | <b>Item no.: 2009-115/000-005</b><br>WMB-Inline; for Smart Printer; 1500 pieces on roll; stretchable 5 - 5.2 mm; plain; snap-on type; red    | <a href="http://www.wago.com/2009-115/000-005">www.wago.com/2009-115/000-005</a> |
| <b>Group marker carrier</b>   |  |  |
|    | <b>Item no.: 2009-193</b><br>Group marker carrier; gray  | <a href="http://www.wago.com/2009-193">www.wago.com/2009-193</a>                 |
|    | <b>Item no.: 2009-192</b><br>Group marker carrier; gray  | <a href="http://www.wago.com/2009-192">www.wago.com/2009-192</a>                 |
|    | <b>Item no.: 2009-191</b><br>Group marker carrier; gray  | <a href="http://www.wago.com/2009-191">www.wago.com/2009-191</a>                 |
| <b>Jumpers</b>  |  |  |
| <b>Jumper</b>   |  |  |
|   | <b>Item no.: 210-123</b><br>Wire commoning chain; insulated; blue  | <a href="http://www.wago.com/210-123">www.wago.com/210-123</a>                   |
|  | <b>Item no.: 2002-402</b><br>Jumper; 2-way; insulated; light gray  | <a href="http://www.wago.com/2002-402">www.wago.com/2002-402</a>                 |
|  | <b>Item no.: 2002-402/000-005</b><br>Jumper; 2-way; insulated; red   | <a href="http://www.wago.com/2002-402/000-005">www.wago.com/2002-402/000-005</a> |
|  | <b>Item no.: 2002-400</b><br>Continuous jumper; 2-way; insulated; light gray   | <a href="http://www.wago.com/2002-400">www.wago.com/2002-400</a>                 |
|  | <b>Item no.: 2002-403</b><br>Jumper; 3-way; insulated; light gray  | <a href="http://www.wago.com/2002-403">www.wago.com/2002-403</a>                 |
|  | <b>Item no.: 2002-404/000-005</b><br>Jumper; 4-way; insulated; red   | <a href="http://www.wago.com/2002-404/000-005">www.wago.com/2002-404/000-005</a> |
|  | <b>Item no.: 2002-403/000-006</b><br>Jumper; 3-way; insulated; blue  | <a href="http://www.wago.com/2002-403/000-006">www.wago.com/2002-403/000-006</a> |
|  | <b>Item no.: 2002-404/000-006</b><br>Jumper; 4-way; insulated; blue  | <a href="http://www.wago.com/2002-404/000-006">www.wago.com/2002-404/000-006</a> |
|  |  |  |

Subject to changes. Please also observe the further product documentation!

Item no.: 2002-403/000-005  
Jumper; 3-way; insulated; red

[www.wago.com/2002-403/000-005](http://www.wago.com/2002-403/000-005)



Item no.: 2002-405/000-005  
Jumper; 5-way; insulated; red

[www.wago.com/2002-405/000-005](http://www.wago.com/2002-405/000-005)



Item no.: 2002-402/000-006  
Jumper; 2-way; insulated; blue

[www.wago.com/2002-402/000-006](http://www.wago.com/2002-402/000-006)



Item no.: 2002-405/000-006  
Jumper; 5-way; insulated; blue

[www.wago.com/2002-405/000-006](http://www.wago.com/2002-405/000-006)



Item no.: 2002-404  
Jumper; 4-way; insulated; light gray

[www.wago.com/2002-404](http://www.wago.com/2002-404)



Item no.: 2002-406/000-006  
Jumper; 6-way; insulated; blue

[www.wago.com/2002-406/000-006](http://www.wago.com/2002-406/000-006)



Item no.: 2002-406/000-005  
Jumper; 6-way; insulated; red

[www.wago.com/2002-406/000-005](http://www.wago.com/2002-406/000-005)



Item no.: 2002-406/020-000  
Delta jumper; insulated; light gray

[www.wago.com/2002-406/020-000](http://www.wago.com/2002-406/020-000)



Item no.: 2002-405  
Jumper; 5-way; insulated; light gray

[www.wago.com/2002-405](http://www.wago.com/2002-405)



Item no.: 2002-407/000-005  
Jumper; 7-way; insulated; red

[www.wago.com/2002-407/000-005](http://www.wago.com/2002-407/000-005)



Item no.: 2002-408  
Jumper; 8-way; insulated; light gray

[www.wago.com/2002-408](http://www.wago.com/2002-408)



Item no.: 2002-408/000-006  
Jumper; 8-way; insulated; blue













[www.wago.com/2002-408/000-006](http://www.wago.com/2002-408/000-006)



















Item no.: 2002-405/011-000  
Star point jumper; 3-way; insulated; light gray

[www.wago.com/2002-405/011-000](http://www.wago.com/2002-405/011-000)









Subject to changes. Please also observe the further product documentation!

|  |  |  |
|--|--|--|
|    | <b>Item no.:</b> 2002-407/000-006<br>Jumper; 7-way; insulated; blue                  | <a href="http://www.wago.com/2002-407/000-006">www.wago.com/2002-407/000-006</a> |
|    | <b>Item no.:</b> 2002-408/000-005<br>Jumper; 8-way; insulated; red                   | <a href="http://www.wago.com/2002-408/000-005">www.wago.com/2002-408/000-005</a> |
|    | <b>Item no.:</b> 2002-407<br>Jumper; 7-way; insulated; light gray                    | <a href="http://www.wago.com/2002-407">www.wago.com/2002-407</a>                 |
|    | <b>Item no.:</b> 2002-406<br>Jumper; 6-way; insulated; light gray                    | <a href="http://www.wago.com/2002-406">www.wago.com/2002-406</a>                 |
|    | <b>Item no.:</b> 2002-410/000-005<br>Jumper; 10-way; insulated; red                  | <a href="http://www.wago.com/2002-410/000-005">www.wago.com/2002-410/000-005</a> |
|   | <b>Item no.:</b> 2002-410/000-006<br>Jumper; 10-way; insulated; blue                 | <a href="http://www.wago.com/2002-410/000-006">www.wago.com/2002-410/000-006</a> |
|  | <b>Item no.:</b> 2002-410<br>Jumper; 10-way; insulated; light gray                   | <a href="http://www.wago.com/2002-410">www.wago.com/2002-410</a>                 |
|  | <b>Item no.:</b> 2002-409/000-006<br>Jumper; 9-way; insulated; blue                  | <a href="http://www.wago.com/2002-409/000-006">www.wago.com/2002-409/000-006</a> |
|  | <b>Item no.:</b> 2002-409/000-005<br>Jumper; 9-way; insulated; red                   | <a href="http://www.wago.com/2002-409/000-005">www.wago.com/2002-409/000-005</a> |
|  | <b>Item no.:</b> 2002-409<br>Jumper; 9-way; insulated; light gray                    | <a href="http://www.wago.com/2002-409">www.wago.com/2002-409</a>                 |
|   | <b>Item no.:</b> 2002-423/000-006<br>Continuous jumper; from 1 to 3; insulated; blue | <a href="http://www.wago.com/2002-423/000-006">www.wago.com/2002-423/000-006</a> |
|   | <b>Item no.:</b> 2002-423<br>Continuous jumper; from 1 to 3; insulated; light gray   | <a href="http://www.wago.com/2002-423">www.wago.com/2002-423</a>                 |
|   | <b>Item no.:</b> 2002-433<br>Jumper; from 1 to 3; insulated; light gray              | <a href="http://www.wago.com/2002-433">www.wago.com/2002-433</a>                 |

Subject to changes. Please also observe the further product documentation!





|  |  |  |
|--|--|--|
|     | <b>Item no.: 2002-434</b><br>Jumper; from 1 to 4; insulated; light gray                          | <a href="http://www.wago.com/2002-434">www.wago.com/2002-434</a>                 |
|     | <b>Item no.: 2002-423/000-005</b><br>Continuous jumper; from 1 to 3; insulated; red              | <a href="http://www.wago.com/2002-423/000-005">www.wago.com/2002-423/000-005</a> |
|     | <b>Item no.: 2002-435</b><br>Jumper; from 1 to 5; insulated; light gray                          | <a href="http://www.wago.com/2002-435">www.wago.com/2002-435</a>                 |
|     | <b>Item no.: 2002-436</b><br>Jumper; from 1 to 6; insulated; light gray                          | <a href="http://www.wago.com/2002-436">www.wago.com/2002-436</a>                 |
|     | <b>Item no.: 2002-437</b><br>Jumper; from 1 to 7; insulated; light gray                          | <a href="http://www.wago.com/2002-437">www.wago.com/2002-437</a>                 |
|     | <b>Item no.: 2002-438</b><br>Jumper; from 1 to 8; insulated; light gray                          | <a href="http://www.wago.com/2002-438">www.wago.com/2002-438</a>                 |
|     | <b>Item no.: 2002-439</b><br>Jumper; from 1 to 9; insulated; light gray                          | <a href="http://www.wago.com/2002-439">www.wago.com/2002-439</a>                 |
|     | <b>Item no.: 2002-440</b><br>Jumper; from 1 to 10; insulated; light gray                         | <a href="http://www.wago.com/2002-440">www.wago.com/2002-440</a>                 |
|     | <b>Item no.: 2002-472</b><br>Staggered jumper; 2-way; insulated; light gray                      | <a href="http://www.wago.com/2002-472">www.wago.com/2002-472</a>                 |
|   | <b>Item no.: 2002-473</b><br>Staggered jumper; 3-way; insulated; light gray                      | <a href="http://www.wago.com/2002-473">www.wago.com/2002-473</a>                 |
|  | <b>Item no.: 2002-475/011-000</b><br>Staggered jumper; 3-way; insulated; light gray              | <a href="http://www.wago.com/2002-475/011-000">www.wago.com/2002-475/011-000</a> |
|   | <b>Item no.: 2002-475</b><br>Staggered jumper; 5-way; insulated; light gray                      | <a href="http://www.wago.com/2002-475">www.wago.com/2002-475</a>                 |
|  | <b>Item no.: 2002-476</b><br>Staggered jumper; 6-way; insulated; light gray                      | <a href="http://www.wago.com/2002-476">www.wago.com/2002-476</a>                 |
|   | <b>Item no.: 2002-474</b><br>Staggered jumper; 4-way; insulated; light gray                      | <a href="http://www.wago.com/2002-474">www.wago.com/2002-474</a>                 |
|  | <b>Item no.: 2002-477</b><br>Staggered jumper; 7-way; insulated; light gray                      | <a href="http://www.wago.com/2002-477">www.wago.com/2002-477</a>                 |
|  | <b>Item no.: 2002-473/011-000</b><br>Staggered jumper; 2-way; from 1 to 3; insulated; light gray | <a href="http://www.wago.com/2002-473/011-000">www.wago.com/2002-473/011-000</a> |

Subject to changes. Please also observe the further product documentation!

|   |  |  |
|---|--|--|
|     | <b>Item no.: 2002-479</b><br>Staggered jumper; 9-way; insulated; light gray          | <a href="http://www.wago.com/2002-479">www.wago.com/2002-479</a>                 |
|     | <b>Item no.: 2002-478</b><br>Staggered jumper; 8-way; insulated; light gray          | <a href="http://www.wago.com/2002-478">www.wago.com/2002-478</a>                 |
|     | <b>Item no.: 2002-479/011-000</b><br>Staggered jumper; insulated; light gray         | <a href="http://www.wago.com/2002-479/011-000">www.wago.com/2002-479/011-000</a> |
|     | <b>Item no.: 2002-480</b><br>Staggered jumper; 10-way; insulated; light gray         | <a href="http://www.wago.com/2002-480">www.wago.com/2002-480</a>                 |
|     | <b>Item no.: 2002-477/011-000</b><br>Staggered jumper; insulated; light gray         | <a href="http://www.wago.com/2002-477/011-000">www.wago.com/2002-477/011-000</a> |
|     | <b>Item no.: 2002-481/011-000</b><br>Staggered jumper; insulated; light gray         | <a href="http://www.wago.com/2002-481/011-000">www.wago.com/2002-481/011-000</a> |
|     | <b>Item no.: 2002-481</b><br>Staggered jumper; 11-way; insulated; light gray         | <a href="http://www.wago.com/2002-481">www.wago.com/2002-481</a>                 |
|    | <b>Item no.: 2002-482</b><br>Staggered jumper; 12-way; insulated; light gray         | <a href="http://www.wago.com/2002-482">www.wago.com/2002-482</a>                 |
|   | <b>Item no.: 210-103</b><br>Wire commoning chain; insulated; black                   | <a href="http://www.wago.com/210-103">www.wago.com/210-103</a>                   |
|  | <b>Item no.: 2002-424/000-006</b><br>Continuous jumper; from 1 to 4; insulated; blue | <a href="http://www.wago.com/2002-424/000-006">www.wago.com/2002-424/000-006</a> |

## Testing and measuring

### Testing accessories

|  |   |  |
|--|---|--|
|  | <b>Item no.: 2009-174</b><br>Test plug adapter; for 4 mm Ø test plugs; for testing TOPJOB®S rail-mounted terminal blocks; gray              | <a href="http://www.wago.com/2009-174">www.wago.com/2009-174</a> |
|  | <b>Item no.: 2009-182</b><br>Testing tap; for max. 2.5 mm <sup>2</sup> ; tool-free connection for individual test wires 0.08 - 2.5 mm; gray | <a href="http://www.wago.com/2009-182">www.wago.com/2009-182</a> |
|  | <b>Item no.: 2002-611</b><br>TOPJOB®S L-type test plug module; modular; 1-pole; 2,50 mm <sup>2</sup> ; gray                                 | <a href="http://www.wago.com/2002-611">www.wago.com/2002-611</a> |
|  | <b>Item no.: 2002-649</b><br>TOPJOB®S L-type spacer module; modular; e.g., for bridging commoned terminal blocks; gray                      | <a href="http://www.wago.com/2002-649">www.wago.com/2002-649</a> |

## Mounting

Subject to changes. Please also observe the further product documentation!

Cover carrier



**Item no.: 709-169**  
Cover carrier; Type 3; gray

[www.wago.com/709-169](http://www.wago.com/709-169)

Cover



**Item no.: 709-156**  
Cover; Type 3; suitable for cover carrier, type 3; 1 m long; transparent

[www.wago.com/709-156](http://www.wago.com/709-156)

Insulation stop

Insulation stop



**Item no.: 2002-171**  
Insulation stop; 0.25 - 0.5 mm<sup>2</sup>; 5 pieces/strip; light gray

[www.wago.com/2002-171](http://www.wago.com/2002-171)



**Item no.: 2002-172**  
Insulation stop; 0.75 - 1 mm<sup>2</sup>; 5 pieces/strip; dark gray

[www.wago.com/2002-172](http://www.wago.com/2002-172)

Downloads

Documentation

Bid Text

|                                    |             |                 |          |
|------------------------------------|-------------|-----------------|----------|
| 2002-2214/1000-490<br>X81 - Datei  | 2019 Apr 23 | xml<br>4.1 kB   | Download |
| 2002-2214/1000-490<br>docx - Datei | 2019 Apr 23 | docx<br>15.6 kB | Download |

Additional Information

|   |  |               |          |
|---|--|---------------|----------|
| Technical Section<br>Technical explanations |  | pdf<br>2.2 MB | Download |
|---|--|---------------|----------|

CAD/CAE-Data

CAD data

|                                 |  |     |          |
|---------------------------------|--|-----|----------|
| 2D/3D Models 2002-2214/1000-490 |  | URL | Download |
|---------------------------------|--|-----|----------|

CAE data

|                                      |  |     |          |
|--------------------------------------|--|-----|----------|
| EPLAN Data Portal 2002-2214/1000-490 |  | URL | Download |
|--------------------------------------|--|-----|----------|

Subject to changes. Please also observe the further product documentation!

|                                      |                     |                          |
|--------------------------------------|---------------------|--------------------------|
| WSCAD Universe 2002-2214/1000-490    | <a href="#">URL</a> | <a href="#">Download</a> |
| ZUKEN Portal 2002-2214/1000-490      | <a href="#">URL</a> | <a href="#">Download</a> |
| EPLAN Data Portal 2002-2214/1000-490 | <a href="#">URL</a> | <a href="#">Download</a> |
| WSCAD Universe 2002-2214/1000-490    | <a href="#">URL</a> | <a href="#">Download</a> |

## Environmental Product Compliance

### Compliance Search

|   |                     |                          |
|---|---------------------|--------------------------|
| Environmental Product Compliance 2002-2214/1000-490   | <a href="#">URL</a> | <a href="#">Download</a> |
| Component terminal block; double-deck; with 2 diodes 1N4007; Top anode; for DIN-rail 35 x 15 and 35 x 7.5; 2.5 mm <sup>2</sup> ; Push-in CAGE CLAMP®; 2,50 mm <sup>2</sup> ; gray |                     |                          |

## Installation Notes

### Conductor termination

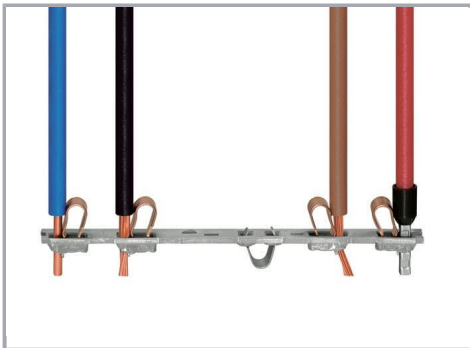

All conductor types at a glance

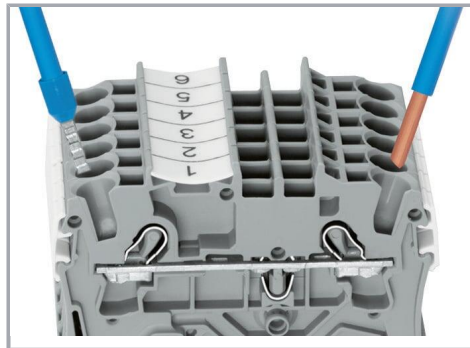

Push-in termination of solid and ferruled conductors

Subject to changes. Please also observe the further product documentation!



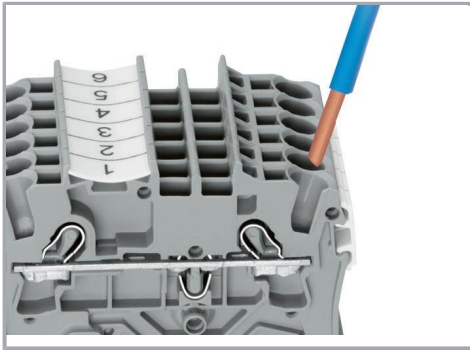

**Inserting a conductor via push-in termination:**

Solid conductors with cross-sections from either one size above, or up to two sizes below, the rated cross-section can be simply pushed in – no tools needed.

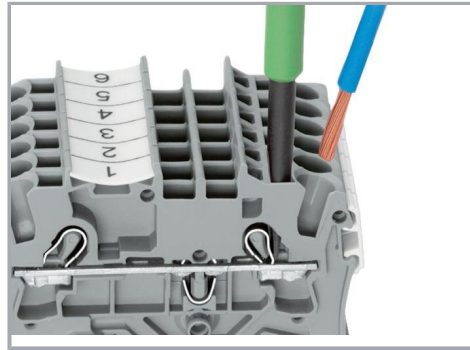

**Inserting a conductor via operating tool:**

Connecting fine-stranded conductors without ferrules, or small cross-sectional conductors that cannot be pushed in, is performed similarly to the original CAGE CLAMP® – just use an operating tool.

**Advantage:**

To open the clamp, the operating tool is inserted vertically. The conductor entry is less than 15 degrees for easier wiring.

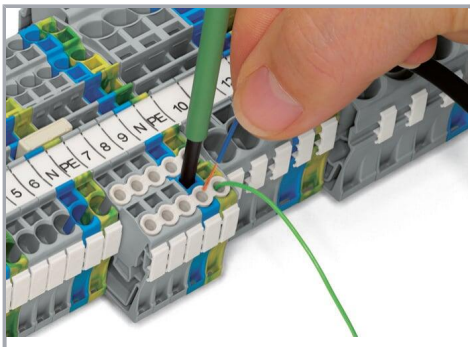

Conductor termination – insulation stop

**Commoning**

Subject to changes. Please also observe the further product documentation!

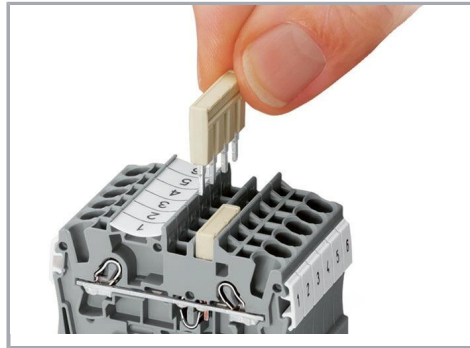
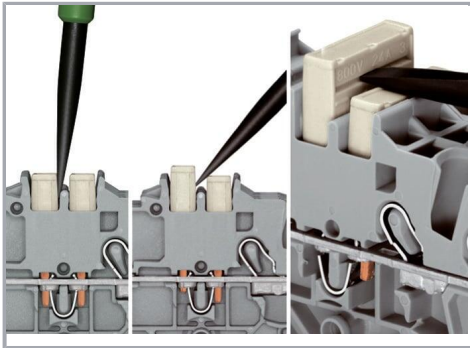

#### Removing a push-in type jumper bar:

Insert the operating tool between the jumper and partition wall of the dual jumper slots, then lift up the jumper.

Place the operating tool in the center of jumpers for up to five contacts (see above), or alternately on both sides for jumpers with more than five contacts.

Insert push-in type jumper bar and push down until it hits backstop.

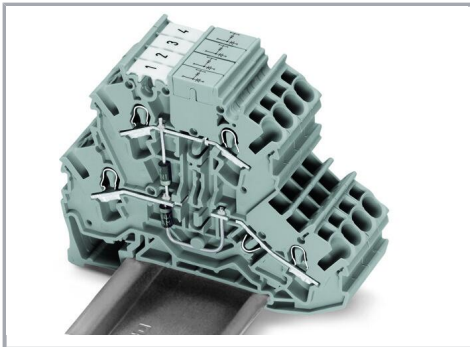

Double-deck diode terminal blocks were specifically developed for custom diode circuits, such as lamp test and collective fault signal circuits.

These terminal blocks provide high-density wiring in a width of just 5.2 mm.

Push-in type jumper bars provide additional options for custom circuit design.

#### Marking

Subject to changes. Please also observe the further product documentation!

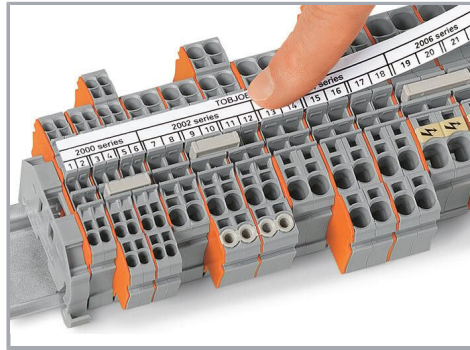
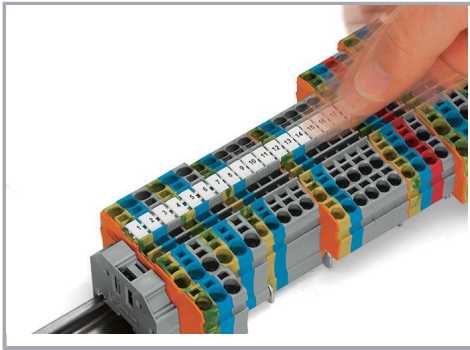

Snapping WMB Inline markers into marker slots.

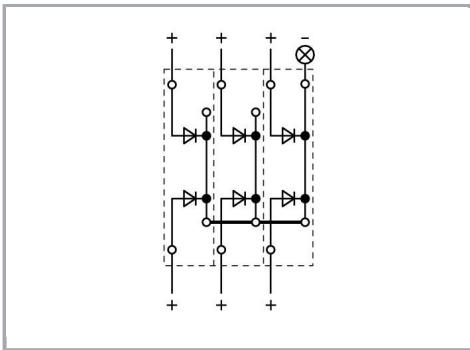

Collective fault signals can be created using the following terminal blocks:

2002-2214/1000-489 or 2002-2214/1000-490

## Product family

### TOPJOB® S

TOPJOB® S: In various industrial applications and modern building installations, WAGO's wide and versatile range of rail-mount terminal blocks provides more than just reliable electrical connections.

[Show all products from the family](#)

Subject to changes. Please also observe the further product documentation!