



WTB4FP-1G31120ZZZ

W4F

MINIATURE PHOTOELECTRIC SENSORS

SICK
Sensor Intelligence.



Illustration may differ



Ordering information

Type	Part no.
WTB4FP-1G311120ZZZ	1223018

Other models and accessories → www.sick.com/W4F

Detailed technical data

Features

Functional principle	Photoelectric proximity sensor
Functional principle detail	Background suppression
Sensing range	
Sensing range min.	4 mm
Sensing range max.	220 mm
Adjustable switching threshold for background suppression	15 mm ... 220 mm
Reference object	Object with 90% remission factor (complies with standard white according to DIN 5033)
Minimum distance between set sensing range and background (black 6% / white 90%)	3 mm, at a distance of 80 mm
Recommended sensing range for the best performance	40 mm ... 140 mm
Emitted beam	
Light source	PinPoint LED
Type of light	Visible red light
Shape of light spot	Point-shaped
Light spot size (distance)	Ø 4.2 mm (130 mm)
Maximum dispersion of the emitted beam around the standardized transmission axis (squint angle)	< +/- 1.5° (at Ta = +23 °C)
Key LED figures	
Normative reference	EN 62471:2008-09 IEC 62471:2006, modified

LED risk group marking	Free group
Wave length	635 nm
Average service life	100,000 h at T _a = +25 °C
Smallest detectable object (MDO) typ.	0.2 mm (At 130 mm distance (object with 90% remission (complies with standard white according to DIN 5033)))
Adjustment	
Teach-Turn adjustment	BluePilot: For setting the sensing range
Indication	
LED blue	BluePilot: sensing range indicator
LED green	Operating indicator Static on: power on
LED yellow	Status of received light beam Static on: object present Static off: object not present

Safety-related parameters

MTTF_D	642 years
DC_{avg}	0 %
T_M (mission time)	20 years (EN ISO 13849) Rate of use: 60 %

Electrical data

Supply voltage U_B	10 V DC ... 30 V DC ¹⁾
Ripple	≤ 5 V _{pp}
Usage category	DC-12 (According to EN 60947-5-2) DC-13 (According to EN 60947-5-2)
Current consumption	≤ 25 mA, without load. At U _B = 24 V
Protection class	III
Digital output	
Number	1
Type	Push-pull: PNP/NPN
Signal voltage PNP HIGH/LOW	Approx. U _B -2.5 V / 0 V
Signal voltage NPN HIGH/LOW	Approx. U _B / < 2.5 V
Output current I _{max.}	≤ 100 mA
Circuit protection outputs	Reverse polarity protected Overcurrent protected Short-circuit protected
Response time	≤ 500 μs ²⁾
Repeatability (response time)	150 μs
Switching frequency	1,000 Hz ³⁾
Pin/Wire assignment	
Function of pin 4/black (BK)	Digital output, light switching, object present → output Q HIGH

¹⁾ Limit values.

²⁾ Signal transit time with resistive load in switching mode.

³⁾ With light/dark ratio 1:1.

Mechanical data

Housing	Rectangular
Dimensions (W x H x D)	16 mm x 40.1 mm x 12.1 mm
Connection	Cable, 3-wire, 2 m
Connection detail	
Deep-freeze property	Do not bend below 0 °C
Conductor size	0.14 mm ²
Cable diameter	Ø 3.4 mm
Length of cable (L)	2 m
Material	
Housing	Plastic, VISTAL®
Front screen	Plastic, PMMA
Cable	PVC
Weight	Approx. 30 g
Maximum tightening torque of the fixing screws	0.4 Nm

Ambient data

Enclosure rating	IP66 (EN 60529) IP67 (EN 60529)
Ambient operating temperature	-40 °C ... +60 °C
Ambient temperature, storage	-40 °C ... +75 °C
Typ. Ambient light immunity	Artificial light: ≤ 50,000 lx Sunlight: ≤ 50,000 lx
Shock resistance	30 g, 11 ms (3 positive and 3 negative shocks along X, Y, Z axes, 18 total shocks (EN60068-2-27))
Vibration resistance	10 Hz ... 1,000 Hz (Amplitude 1 mm, 3 x 30 min (EN60068-2-6))
Air humidity	35 % ... 95 %, Relative humidity (no condensation)
Electromagnetic compatibility (EMC)	EN 60947-5-2
Resistance to cleaning agent	ECOLAB
UL File No.	NRKH.E181493 & NRKH7.E181493

Classifications

eCl@ss 5.0	27270904
eCl@ss 5.1.4	27270904
eCl@ss 6.0	27270904
eCl@ss 6.2	27270904
eCl@ss 7.0	27270904
eCl@ss 8.0	27270904
eCl@ss 8.1	27270904
eCl@ss 9.0	27270904
eCl@ss 10.0	27270904
eCl@ss 11.0	27270904
eCl@ss 12.0	27270903
ETIM 5.0	EC002719

ETIM 6.0	EC002719
ETIM 7.0	EC002719
ETIM 8.0	EC002719
UNSPSC 16.0901	39121528

Connection type

Cable, 3-wire

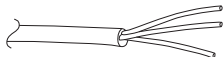

Connection diagram

Cd-043

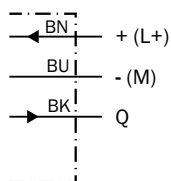

Truth table

Push-pull: PNP/NPN – dark switching \bar{Q}

	Dark switching \bar{Q} (normally closed (upper switch), normally open (lower switch))	
	Object not present → Output HIGH	Object present → Output LOW
Light receive	✗	✓
Light receive indicator	✗	☀
Load resistance to L+	✗	⚠
Load resistance to M	⚠	✗

Push-pull: PNP/NPN - light switching Q

	Light switching Q (normally open (upper switch), normally closed (lower switch))	
	Object not present → Output LOW	Object present → Output HIGH
Light receive	✗	✓
Light receive indicator	✗	☀
Load resistance to L+	⚠	✗
Load resistance to M	✗	⚠

Characteristic curve

Minimum distance in mm (y) between the set sensing range and white background (90 % remission)

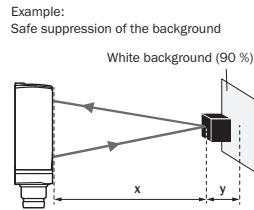
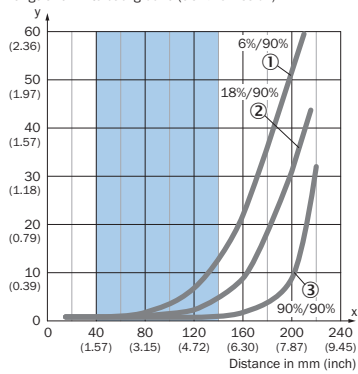

Black object (6 % remission)
 Set sensing range $x = 120$ mm
 Needed minimum distance to white background $y = 7$ mm

Recommended sensing range for the best performance

- ① Black object, 6% remission factor
- ② Gray object, 18% remission factor
- ③ White object, 90% remission factor

Light spot size

Dimensions in mm (inch)

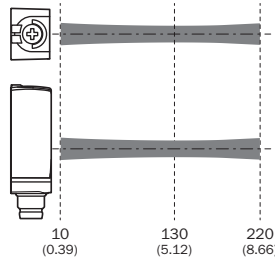
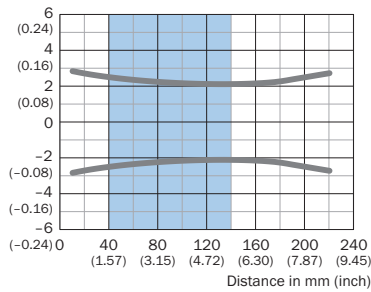

Recommended sensing range for the best performance

Sensing range diagram

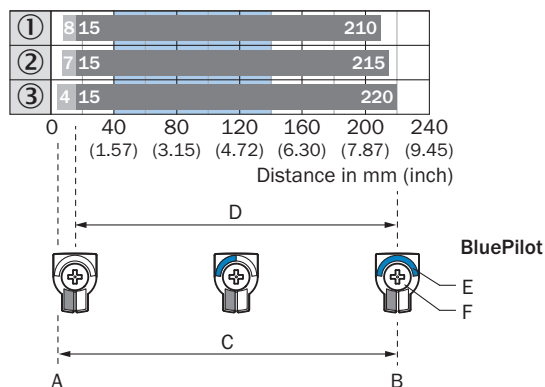

- A = Sensing range min. in mm
- B = Sensing range max. in mm
- C = Viewing range
- D = Adjustable switching threshold for background suppression
- E = Sensing range indicator
- F = Teach-Turn adjustment

■ Recommended sensing range for the best performance

- ① Black object, 6% remission factor
- ② Gray object, 18% remission factor
- ③ White object, 90% remission factor

Adjustments

Display and adjustment elements

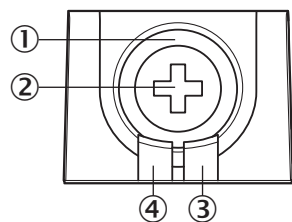

- ① LED blue
- ② Teach-Turn adjustment
- ③ LED yellow
- ④ LED green

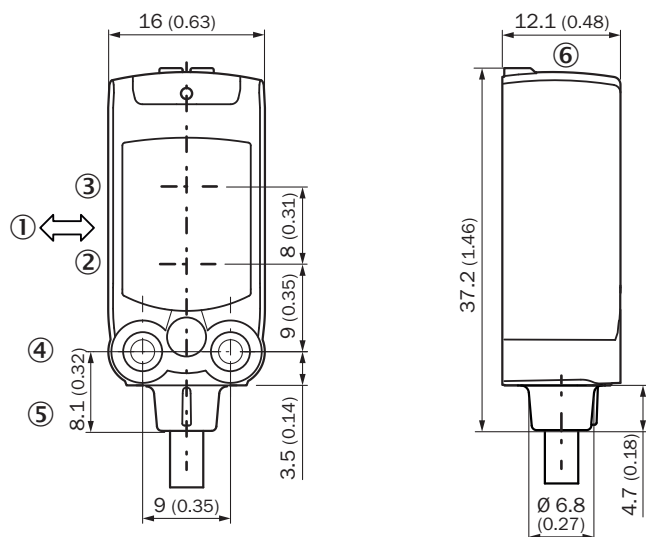

Dimensional drawing (Dimensions in mm (inch))



- ① Standard direction of the material being detected
- ② Center of optical axis, sender
- ③ Center of optical axis, receiver
- ④ M3 mounting hole
- ⑤ Connection
- ⑥ Display and adjustment elements

Recommended accessories

Other models and accessories → www.sick.com/W4F

	Brief description	Type	Part no.
Mounting brackets and plates			
	Mounting bracket for wall mounting, Stainless steel 1.4571, mounting hardware included	BEF-W4-A	2051628
Plug connectors and cables			
	Head A: male connector, M8, 3-pin, straight Cable: unshielded	STE-0803-G	6037322

SICK AT A GLANCE

SICK is one of the leading manufacturers of intelligent sensors and sensor solutions for industrial applications. A unique range of products and services creates the perfect basis for controlling processes securely and efficiently, protecting individuals from accidents and preventing damage to the environment.

We have extensive experience in a wide range of industries and understand their processes and requirements. With intelligent sensors, we can deliver exactly what our customers need. In application centers in Europe, Asia and North America, system solutions are tested and optimized in accordance with customer specifications. All this makes us a reliable supplier and development partner.

Comprehensive services complete our offering: SICK LifeTime Services provide support throughout the machine life cycle and ensure safety and productivity.

For us, that is “Sensor Intelligence.”

WORLDWIDE PRESENCE:

Contacts and other locations –www.sick.com