



JX

Compact and complete

Model: 3G3JX

200 V Class Three-Phase Input 0.2 to 7.5 kW

200 V Class Single-Phase Input 0.2 to 2.2 kW

400 V Class Three-Phase Input 0.4 to 7.5 kW

USER'S MANUAL



OMRON

Introduction

Thank you for choosing the general-purpose Inverter 3G3JX. This User's Manual (hereinafter called "this manual") describes the parameter setting methods required for installation/wiring and operation of the 3G3JX model, as well as troubleshooting and inspection methods.

- This manual should be delivered to the actual end user of the product.
- After reading this manual, keep it handy for future reference.
- This manual describes the specifications and functions of the product as well as the relations between them. You should assume that anything not described in this manual is not possible with the product.
- Intended readers
This manual is intended for:
Those with knowledge of electrical systems (qualified electrical engineers or the equivalent), and also in charge of:
 - Introducing the control equipment
 - Designing the control system
 - Installing and/or connecting the control equipment
 - Field management

Read and Understand This Manual

Please read and understand this manual before using the product. Please consult your OMRON representative if you have any questions or comments.

Warranty and Limitations of Liability

WARRANTY

<p>OMRON's exclusive warranty is that the products are free from defects in materials and workmanship for a period of one year (or other period if specified) from date of sale by OMRON.</p>

<p>OMRON MAKES NO WARRANTY OR REPRESENTATION, EXPRESS OR IMPLIED, REGARDING NON-INFRINGEMENT, MERCHANTABILITY, OR FITNESS FOR PARTICULAR PURPOSE OF THE PRODUCTS. ANY BUYER OR USER ACKNOWLEDGES THAT THE BUYER OR USER ALONE HAS DETERMINED THAT THE PRODUCTS WILL SUITABLY MEET THE REQUIREMENTS OF THEIR INTENDED USE. OMRON DISCLAIMS ALL OTHER WARRANTIES, EXPRESS OR IMPLIED.</p>

LIMITATIONS OF LIABILITY

<p>OMRON SHALL NOT BE RESPONSIBLE FOR SPECIAL, INDIRECT, OR CONSEQUENTIAL DAMAGES, LOSS OF PROFITS OR COMMERCIAL LOSS IN ANY WAY CONNECTED WITH THE PRODUCTS, WHETHER SUCH CLAIM IS BASED ON CONTRACT, WARRANTY, NEGLIGENCE, OR STRICT LIABILITY.</p>

<p>In no event shall the responsibility of OMRON for any act exceed the individual price of the product on which liability is asserted.</p>

<p>IN NO EVENT SHALL OMRON BE RESPONSIBLE FOR WARRANTY, REPAIR, OR OTHER CLAIMS REGARDING THE PRODUCTS UNLESS OMRON'S ANALYSIS CONFIRMS THAT THE PRODUCTS WERE PROPERLY HANDLED, STORED, INSTALLED, AND MAINTAINED AND NOT SUBJECT TO CONTAMINATION, ABUSE, MISUSE, OR INAPPROPRIATE MODIFICATION OR REPAIR.</p>
--

Application Considerations

SUITABILITY FOR USE

OMRON shall not be responsible for conformity with any standards, codes, or regulations that apply to the combination of products in the customer's application or use of the products.

At the customer's request, OMRON will provide applicable third party certification documents identifying ratings and limitations of use that apply to the products. This information by itself is not sufficient for a complete determination of the suitability of the products in combination with the end product, machine, system, or other application or use.

The following are some examples of applications for which particular attention must be given. This is not intended to be an exhaustive list of all possible uses of the products, nor is it intended to imply that the uses listed may be suitable for the products:

- Outdoor use, uses involving potential chemical contamination or electrical interference, or conditions or uses not described in this manual.
- Nuclear energy control systems, combustion systems, railroad systems, aviation systems, medical equipment, amusement machines, vehicles, safety equipment, and installations subject to separate industry or government regulations.
- Systems, machines, and equipment that could present a risk to life or property.

Please know and observe all prohibitions of use applicable to the products.

NEVER USE THE PRODUCTS FOR AN APPLICATION INVOLVING SERIOUS RISK TO LIFE OR PROPERTY WITHOUT ENSURING THAT THE SYSTEM AS A WHOLE HAS BEEN DESIGNED TO ADDRESS THE RISKS, AND THAT THE OMRON PRODUCTS ARE PROPERLY RATED AND INSTALLED FOR THE INTENDED USE WITHIN THE OVERALL EQUIPMENT OR SYSTEM.

PROGRAMMABLE PRODUCTS

OMRON shall not be responsible for the user's programming of a programmable product, or any consequence thereof.

Disclaimers

CHANGE IN SPECIFICATIONS

<p>Product specifications and accessories may be changed at any time based on improvements and other reasons.</p>

<p>It is our practice to change model numbers when published ratings or features are changed, or when significant construction changes are made. However, some specifications of the products may be changed without any notice. When in doubt, special model numbers may be assigned to fix or establish key specifications for your application on your request. Please consult with your OMRON representative at any time to confirm actual specifications of purchased products.</p>
--

DIMENSIONS AND WEIGHTS

<p>Dimensions and weights are nominal and are not to be used for manufacturing purposes, even when tolerances are shown.</p>
--

PERFORMANCE DATA

<p>Performance data given in this manual is provided as a guide for the user in determining suitability and does not constitute a warranty. It may represent the result of OMRON's test conditions, and the users must correlate it to actual application requirements. Actual performance is subject to the OMRON Warranty and Limitations of Liability.</p>

ERRORS AND OMISSIONS

<p>The information in this manual has been carefully checked and is believed to be accurate; however, no responsibility is assumed for clerical, typographical, or proofreading errors, or omissions.</p>

Safety Precautions

■ Indications and Meanings of Safety Information

In this user's manual, the following precautions and signal words are used to provide information to ensure the safe use of the 3G3JX Inverter.









The information provided here is vital to safety. Strictly observe the precautions provided.









■ Meanings of Signal Words

 <b style="font-size: 24px; margin-left: 10px;">WARNING	<p>Indicates an imminently hazardous situation which, if not avoided, is likely to result in serious injury or may result in death. Additionally there may be severe property damage.</p>
--	---

 <b style="font-size: 24px; margin-left: 10px;">CAUTION	<p>Indicates a potentially hazardous situation which, if not avoided, may result in minor or moderate injury or in property damage.</p>
--	---





■ Alert Symbols in This Document

 <b style="font-size: 24px; margin-left: 10px;">WARNING	
	<p>Turn off the power supply and implement wiring correctly. Not doing so may result in a serious injury due to an electric shock.</p>
	<p>Wiring work must be carried out only by qualified personnel. Not doing so may result in a serious injury due to an electric shock.</p>
	<p>Be sure to ground the unit. Not doing so may result in a serious injury due to an electric shock or fire. (200-V class: type-D grounding, 400-V class: type-C grounding)</p>
	<p>Do not remove the front cover during the power supply and 5 minutes after the power shutoff. Doing so may result in a serious injury due to an electric shock.</p>
	<p>Do not operate the Digital Operator or switches with wet hands. Doing so may result in a serious injury due to an electric shock.</p>
	<p>Inspection of the Inverter must be conducted after the power supply has been turned off. Not doing so may result in a serious injury due to an electric shock. The main power supply is not necessarily shut off even if the emergency shutoff function is activated.</p>
	<p>Do not change wiring, mode change switches (S7, S8), optional devices or replace cooling fans while the input power is being supplied. Doing so may result in a serious injury due to an electric shock.</p>







 CAUTION	
	Do not connect resistors to the terminals (+1, P/+2, N/-) directly. Doing so might result in a small-scale fire, heat generation or damage to the unit.
	Install a stop motion device to ensure safety. Not doing so might result in a minor injury. (A holding brake is not a stop motion device designed to ensure safety.)
	Be sure to use a specified type of braking resistor/regenerative braking unit. In case of a braking resistor, install a thermal relay that monitors the temperature of the resistor. Not doing so might result in a moderate burn due to the heat generated in the braking resistor/regenerative braking unit. Configure a sequence that enables the Inverter power to turn off when unusual overheating is detected in the braking resistor/regenerative braking unit.
	The Inverter has high voltage parts inside which, if short-circuited, might cause damage to itself or other property. Place covers on the openings or take other precautions to make sure that no metal objects such as cutting bits or lead wire scraps go inside when installing and wiring.
	Do not touch the Inverter fins, braking resistors and the motor, which become too hot during the power supply and for some time after the power shutoff. Doing so may result in a burn.
	Take safety precautions such as setting up a molded-case circuit breaker (MCCB) that matches the Inverter capacity on the power supply side. Not doing so might result in damage to property due to the short circuit of the load.
	Do not dismantle, repair or modify the product. Doing so may result in an injury.

■UL Cautions, Warnings and Instructions

The warnings and instructions in this section summarizes the procedures necessary to ensure an inverter installation complies with Underwriters Laboratories guidelines.

	“USE 60/75°C Cu wire only” or equivalent. For models 3G3JX-AB007, -AB015, -AB022, -A2015, -A2022, -A2037, -A2055, -A2075
	“USE 75°C Cu wire only” or equivalent. For models 3G3JX-AB002, -AB004, -A2002, -A2004, -A2007, -A4022, -A4037, -A4055, -A4075
	“Use 60°C Cu wire only” or equivalent. For models 3G3JX-A4004, -A4007 and -A4015
	“Open Type Equipment”
	“Suitable for use on a circuit capable of delivering not more than 100k rms symmetrical amperes, 240V maximum when protected by Class CC, G, J or R fuses or circuit having an interrupting rating not less than 100,000 rms symmetrical amperes, 240 volts maximum”. For the single and three phases 200V models.

Safety Precautions

	"Suitable for use on a circuit capable of delivering not more than 100k rms symmetrical amperes, 480V maximum when protected by Class CC, G, J or R fuses or circuit having an interrupting rating not less than 100,000 rms symmetrical amperes, 480 volts maximum". For the 400V models
	"Install device in pollution degree 2 environment".
	"Maximum Surrounding Air Temperature 50°C" or equivalent
	"Caution-Risk of electric shock-capacitor discharge time is at least 5 minutes."
	"Solid state motor overload protection is provided in each model".
	"Integral solid state short circuit protection does not provide branch circuit protection. Branch circuit protection must be provided in accordance with the National Electric Code and any additional local codes" or equivalent.

Precautions for Safe Use

■ Installation and Storage

Do not store or use the product in the following places:

- Locations subject to direct sunlight.
- Locations subject to ambient temperature exceeding the specifications.
- Locations subject to relative humidity exceeding the specifications.
- Locations subject to condensation due to severe temperature fluctuations.
- Locations subject to corrosive or flammable gases.
- Locations subject to exposure to combustibles.
- Locations subject to dust (especially iron dust) or salt.
- Locations subject to exposure to water, oil, or chemicals.
- Locations subject to shock or vibration.

■ Transporting, Installation, and Wiring

- Do not drop or apply a strong impact on the product. Doing so may result in damaged parts or malfunction.
- Do not hold by the front cover, but hold by the fins during transportation.
- Do not connect an AC power supply voltage to the control input/output terminals. Doing so may result in damage to the product.
- Be sure to tighten the screws on the terminal block securely.
Wiring work must be done after installing the unit body.
- Do not connect any load other than a three-phase inductive motor to the U, V, and W output terminals.
- Take sufficient shielding measures when using the product in the following locations. Not doing so may result in damage to the product.
 - Locations subject to static electricity or other forms of noise.
 - Locations subject to strong magnetic fields.
 - Locations close to power lines.

■ Operation and Adjustment

- Be sure to confirm the permissible range of motors and machines before operation because the Inverter speed can be changed easily from low to high.
- Provide a separate holding brake if necessary.

■ Maintenance and Inspection

- Be sure to confirm safety before conducting maintenance, inspection or parts replacement.

Precautions for Correct Use

■ Installation

- Mount the product vertically on a wall or on a DIN track (optional) with the product's longer sides upright. The material of the wall has to be nonflammable such as a metal plate.

■ Main Circuit Power Supply

- Confirm that the rated input voltage of the Inverter is the same as AC power supply voltage.

■ Error Retry Function

- Do not come close to the machine when using the error retry function because the machine may abruptly start when stopped by an alarm.
- Be sure to confirm the RUN signal is turned off before resetting the alarm because the machine may abruptly start.

■ Non-Stop Function at Momentary Power Interruption

- Do not come close to the machine when selecting restart in the non-stop function at momentary power interruption selection (b050) because the machine may abruptly start after the power is turned on.

■ Operation Stop Command

- Provide a separate emergency stop switch because the STOP key on the Digital Operator is valid only when function settings are performed.
- When checking a signal during the power supply and the voltage is erroneously applied to the control input terminals, the motor may start abruptly. Be sure to confirm safety before checking a signal.

■ Product Disposal

- Comply with the local ordinance and regulations when disposing of the product.

Warning Labels

Warning labels are located on the Inverter as shown in the following illustration. Be sure to follow the instructions.

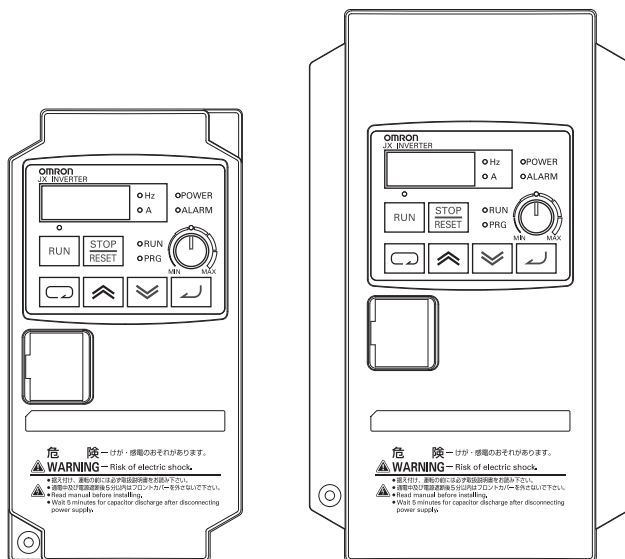

Warning Description



Checking Before Unpacking

■Checking the Product

On delivery, be sure to check that the delivered product is the Inverter 3G3JX model that you ordered.

Should you find any problems with the product, immediately contact your nearest local sales representative or OMRON sales office.

●Checking the Nameplate

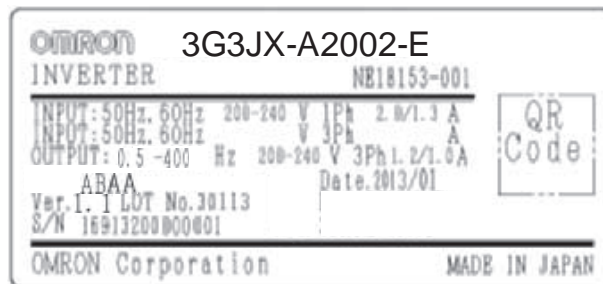

●Checking the Model

3 G 3 J X - A B 0 0 2 - E F

F: Built-in EMC filter

E: Europe standard

Maximum applicable motor capacity

002	0.2 kW
004	0.4 kW
007	0.75 kW
015	1.5 kW
022	2.2 kW
037	3.7 kW
040	4.0 kW
055	5.5 kW
075	7.5 kW

Voltage class

2	3-phase 200 V AC (200-V class)
B	1-phase 200 V AC (200-V class)
4	3-phase 400 V AC (400-V class)

Enclosure rating

A	Panel-mounting (IP10 min.) or closed wall-mounting models
---	---

■Checking the Accessories

Note that this manual is the only accessory included with the 3G3JX model. Mounting screws and other necessary parts must be provided by the user.

Revision History

■ A manual revision code appears as a suffix to the catalog number located at the lower left of the front and back covers.

Cat. No. I558-E2-03

↑ Revision code

Revision code	Revision date	Changes and revision pages
02	October 2009	First printing
03	May 2012	Minor changes

About This Manual

This User's Manual is compiled chapter by chapter for user's convenience as follows. Understanding the following configuration ensures more effective use of the product.

	Overview
Chapter 1 Overview	Describes features and names of parts.
Chapter 2 Design	Provides external dimensions, installation dimensions, peripheral device design/selection instructions, and other information necessary for design.
Chapter 3 Operation	Describes names of parts, the Inverter's operations, including how to use the keys on the Digital Operator, and the monitor function.
Chapter 4 Functions	Describes the functions of the Inverter.
Chapter 5 Maintenance Operations	Describes the causes and their countermeasures if the Inverter fails, including the solutions to possible troubles (troubleshooting).
Chapter 6 Inspection and Maintenance	Describes items for periodic inspection and/or maintenance for the Inverter.
Chapter 7 Specifications	Provides Inverter specifications, as well as the specifications and dimensions of peripheral devices.
Appendix	Describes the summarized parameter settings as a reference for users who have used this Inverter and understood the functions.

Contents

Introduction	1
Read and Understand This Manual	2
Safety Precautions	5
Precautions for Safe Use.....	8
Precautions for Correct Use	9
Checking Before Unpacking	11
Revision History.....	12
About This Manual.....	13
Chapter 1 Overview	
1-1 Functions	1-2
1-2 Appearance and Names of Parts.....	1-4
Chapter 2 Design	
2-1 Installation.....	2-2
2-2 Wiring.....	2-7
Chapter 3 Operation	
3-1 Test Run Procedure.....	3-3
3-2 Test Run Operation	3-4
3-3 Part Names and Descriptions of the Digital Operator	3-8
3-4 Operation Procedure (Example: Factory Default).....	3-10
3-5 Parameter Transition	3-16
3-6 Parameter List	3-17
Chapter 4 Functions	
4-1 Monitor Mode.....	4-2
4-2 Function Mode	4-6
Chapter 5 Maintenance Operations	
5-1 Special Display List (Error Codes)	5-2
5-2 Troubleshooting	5-6
Chapter 6 Inspection and Maintenance	
6-1 Inspection and Maintenance	6-2
6-2 Storage	6-8

Contents

Chapter 7 Specifications

7-1	Standard Specification List.....	7-2
7-2	Measurement Method of Output Voltage	7-6
7-3	Dimensional Drawing	7-7
7-4	Options.....	7-13

Appendix

Appendix-1	Parameter List	App-2
Appendix-2	Product Life Curve	App-18

Index

Chapter 1

Overview

1-1	Functions	1-2
1-2	Appearance and Names of Parts	1-4

1-1 Functions

3G3JX Inverter Models

Rated voltage	Enclosure rating	Max. applicable motor capacity	Model
3-phase 200 V AC	IP20	0.2 kW	3G3JX-A2002
		0.4 kW	3G3JX-A2004
		0.75 kW	3G3JX-A2007
		1.5 kW	3G3JX-A2015
		2.2 kW	3G3JX-A2022
		3.7 kW	3G3JX-A2037
		5.5 kW	3G3JX-A2055
7.5 kW		3G3JX-A2075	
3-phase 400 V AC		0.4 kW	3G3JX-A4004
		0.75 kW	3G3JX-A4007
		1.5 kW	3G3JX-A4015
		2.2 kW	3G3JX-A4022
		4.0 kW	3G3JX-A4040
1-phase 200 V AC		5.5 kW	3G3JX-A4055
	7.5 kW	3G3JX-A4075	
	0.2 kW	3G3JX-AB002	
	0.4 kW	3G3JX-AB004	
	0.75 kW	3G3JX-AB007	
		1.5 kW	3G3JX-AB015
		2.2 kW	3G3JX-AB022

International Standards Models (EC Directives and UL/cUL Standards)

The 3G3JX Inverter meets the EC Directives and UL/cUL standard requirements for worldwide use.

Classification		Applicable standard
EC Directives	EMC Directive	EN61800-3: 2004
	Low-voltage Directive	EN61800-5-1: 2003
UL/cUL Standards		UL508C

Compact Simplified Inverter for Customer's Environment and Application Demands

■Simple Wiring and Easy Installation

The main circuit adopts upper/lower wiring as with a conductor. In addition, the side-by-side mounting of the Inverters and the built-in zero-phase reactor contribute to space saving in control panel.

■Wide Ranging Capacity and Power Supply

In spite of its compact size, the 3G3JX Inverter provides a wide ranging capacity from 0.2 to 7.5 kW. Moreover, the three-phase 200 V, three-phase 400 V, and single/three-phase 200 V common types are made to meet the power supply specifications for use outside Japan.

■PID Function

The PID function is featured for the easier control of the fan and pump. It helps to control airflow and pressure.

■Emergency Shutoff Function

Switching the dedicated switch (S8) changes from the multi-function input (input 3) to the emergency shutoff input. You can directly turn off a motor control power module without operating the software.

■Compliance With Standards

The 3G3JX Series has achieved compliance with CE and UL/cUL.

■The RoHS Directive

The standard model meets the requirements of the RoHS Directive.

■Noise and Harmonics Suppression Option

The three-phase models incorporate a zero-phase reactor (radio noise filter) as a standard specification.

For the single/three-phase common type, optional suppression is available.

When the optional DC reactor is added, the 3G3JX Series will also meet the requirements specified by the Ministry of Land, Infrastructure, Transport and Tourism of Japan.

■Handles a Variety of I/O Signals

The 3G3JX Series can handle a variety of I/O signals for wide-ranging applications.

- Analog voltage input: 0 to 10 V
- Analog current input: 4 to 20 mA

1-2 Appearance and Names of Parts

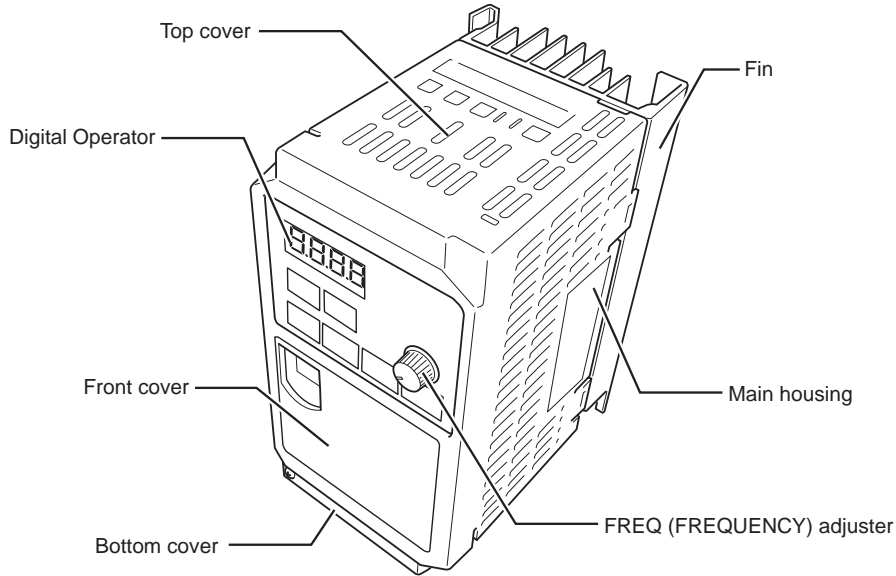

- The size of the fin varies with the motor capacity.
- There are two sizes depending on the motor capacity, but the fundamental structure is the same.
- Remove the front cover when connecting the power supply, the motor, and the control signal.

Connection to RJ45 Jack

Connect the communications cable after opening the cover of the communications connector. Remove the front cover to switch communications. Refer to "Removing the Front Cover" (page 2-7) for instructions on how to remove the front cover.

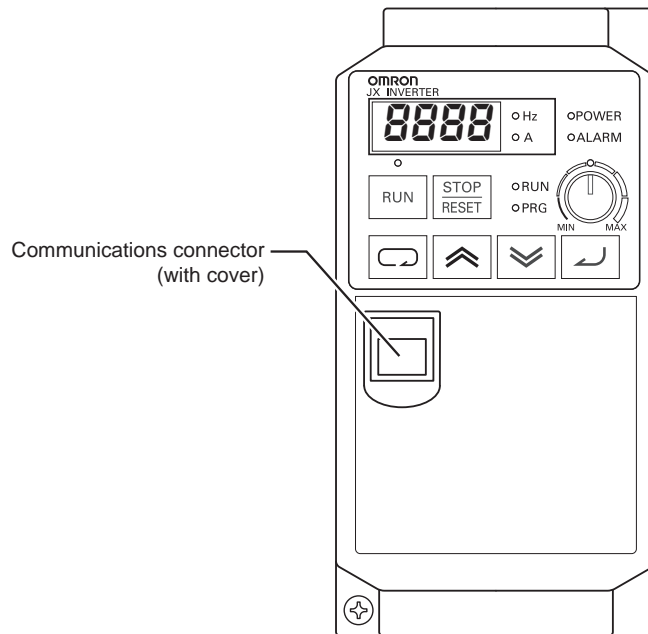

*The cover of the communications connector is removable. Remove the front cover to attach it.

Names of Parts Inside the Front Cover

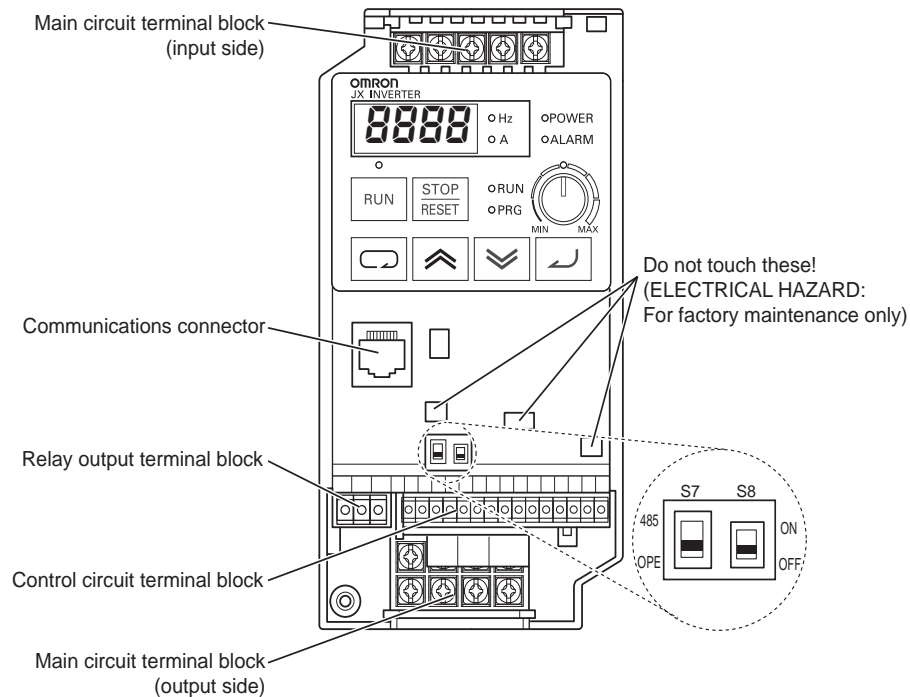

S7: OPE/485 communications selector (Default = OPE side)

S8: Emergency shutoff function selector (Default = OFF)

(Caution)

Do not switch the emergency shutoff function selector (S8) without reason as the allocation of the multi-function input terminals may change.





For details, refer to "Emergency Shutoff Input Function" (page 4-46).





Chapter 2

Design

2-1	Installation	2-2
2-2	Wiring	2-7

2-1 Installation

 WARNING	
	Turn off the power supply and implement wiring correctly. Not doing so may result in a serious injury due to an electric shock.
	Wiring work must be carried out only by qualified personnel. Not doing so may result in a serious injury due to an electric shock.
	Be sure to ground the unit. Not doing so may result in a serious injury due to an electric shock or fire. (200-V class: type-D grounding, 400-V class: type-C grounding)

 CAUTION	
	Do not connect resistors to the terminals (PD+1, P/+, N/-) directly. Doing so might result in a small-scale fire, heat generation or damage to the unit.
	Install a stop motion device to ensure safety. Not doing so might result in a minor injury. (A holding brake is not a stop motion device designed to ensure safety.)
	Be sure to use a specified type of braking resistor/regenerative braking unit. In case of a braking resistor, install a thermal relay that monitors the temperature of the resistor. Not doing so might result in a moderate burn due to the heat generated in the braking resistor/regenerative braking unit. Configure a sequence that enables the Inverter power to turn off when unusual overheating is detected in the braking resistor/regenerative braking unit.
	The Inverter has high voltage parts inside which, if short-circuited, might cause damage to itself or other property. Place covers on the openings or take other precautions to make sure that no metal objects such as cutting bits or lead wire scraps go inside when installing and wiring.

Safety Information

■ Installation and Storage

- Do not store or use the product in the following places.
- Locations subject to direct sunlight.
 - Locations subject to ambient temperature exceeding the specifications.
 - Locations subject to relative humidity exceeding the specifications.
 - Locations subject to condensation due to severe temperature fluctuations.
 - Locations subject to corrosive or flammable gases.
 - Locations subject to exposure to combustibles.
 - Locations subject to dust (especially iron dust) or salts.
 - Locations subject to exposure to water, oil, or chemicals.
 - Locations subject to shock or vibration.

■Transporting, Installation, and Wiring

- Do not drop or apply strong impact on the product. Doing so may result in damaged parts or malfunction.
- Do not hold by the front cover, but hold by the fins during transportation.
- Do not connect an AC power supply voltage to the control input/output terminals. Doing so may result in damage to the product.
- Be sure to tighten the screws on the terminal block securely.
Wiring work must be done after installing the unit body.
- Do not connect any load other than a three-phase inductive motor to the U, V, and W output terminals.
- Take sufficient shielding measures when using the product in the following locations. Not doing so may result in damage to the product.
 - Locations subject to static electricity or other forms of noise.
 - Locations subject to strong magnetic fields.
 - Locations close to power lines.

Precautions for Use

■Installation

- Install the Inverter vertically on the wall or DIN tracks (optional).
Install the Inverter on a nonflammable wall surface material, like metal.

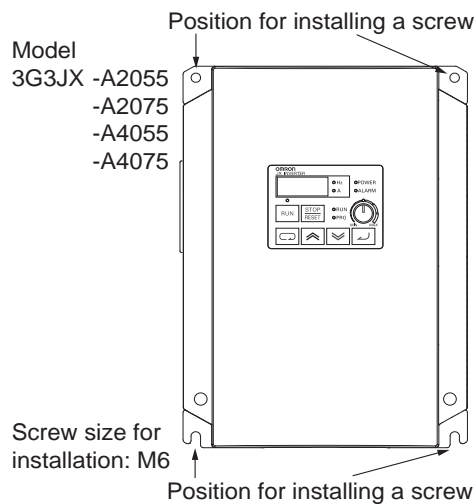
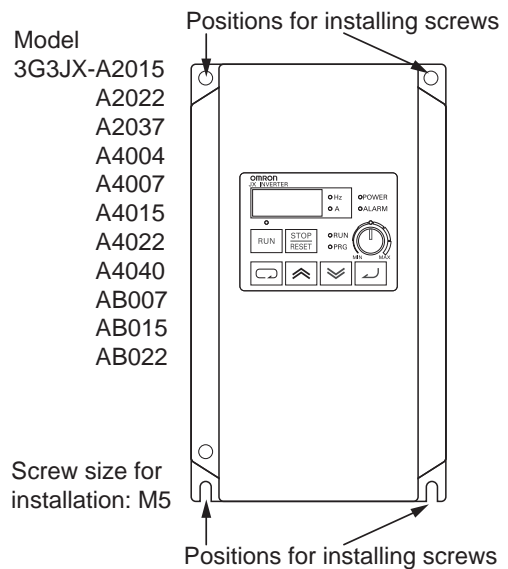
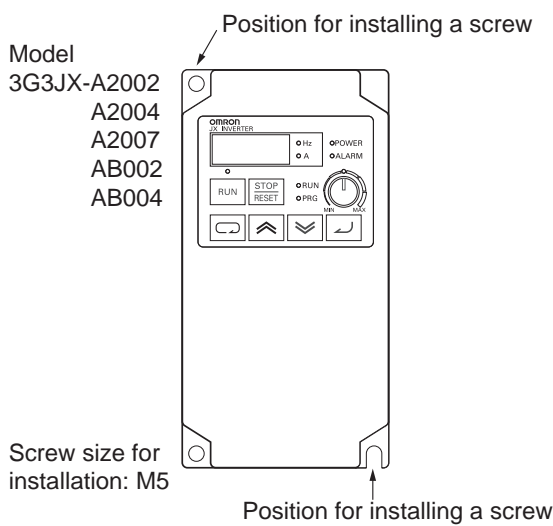

■ Main Circuit Power Supply

- Confirm that the rated input voltage of the Inverter matches the AC power supply voltage.

■ Installation Environment

- Increased ambient temperatures will shorten the life of the Inverter.
 - Keep the Inverter away from heating elements (such as a braking resistor, DC reactor, etc.).
- If the Inverter is installed in a control panel, keep the ambient temperature within the range of the specifications, taking dimensions and ventilation into consideration.

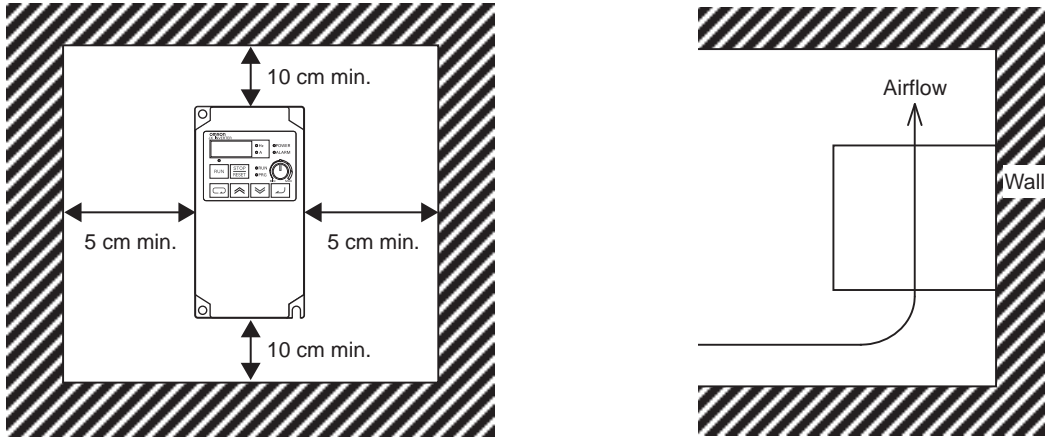

- You can install multiple 3G3JX Inverters side by side in the control panel (side-by-side installation). Again, keep the ambient temperature within the specified range (40°C or below).

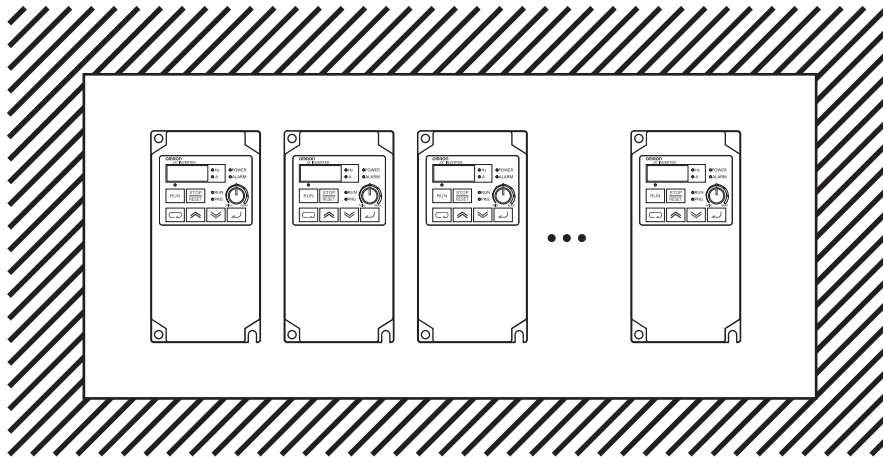

- If the ambient temperature is from 40°C through to 50°C, the carrier frequency should be reduced and the Inverter capacity should be increased. Refer to ambient temperature derating.

- To raise the carrier frequency, reduce the output current (or derate the rated current) as shown in the graph below.

(1) Ambient temperature 40°C

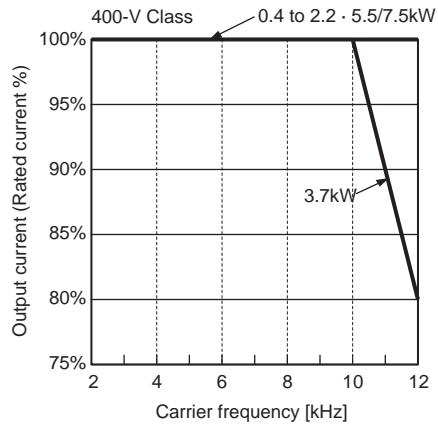
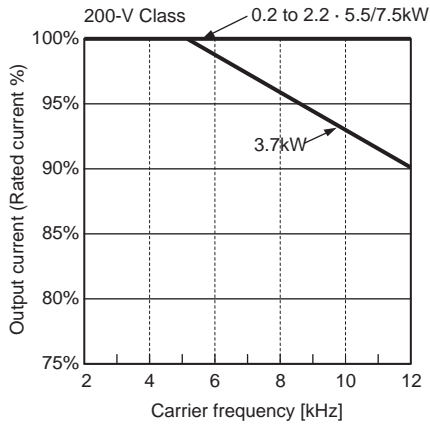

(2) Ambient temperature 50°C

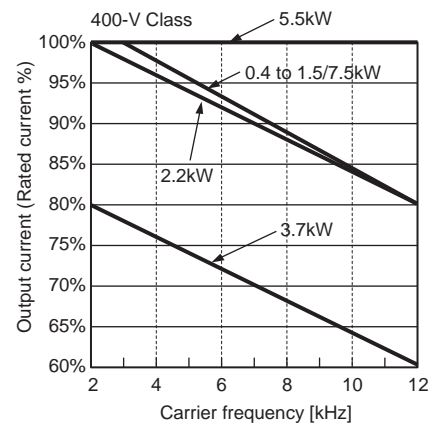
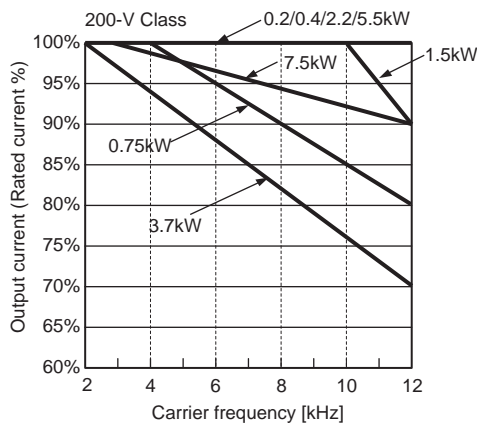

(3) Side-By-Side installation (ambient temperature:40°C)

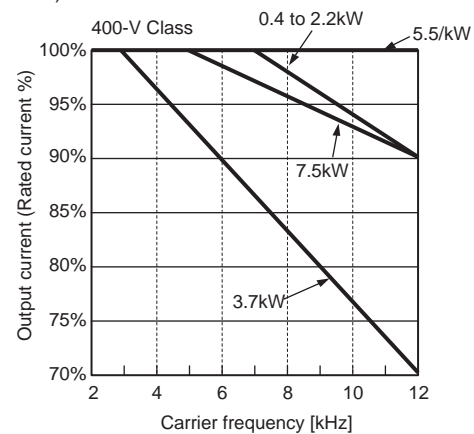
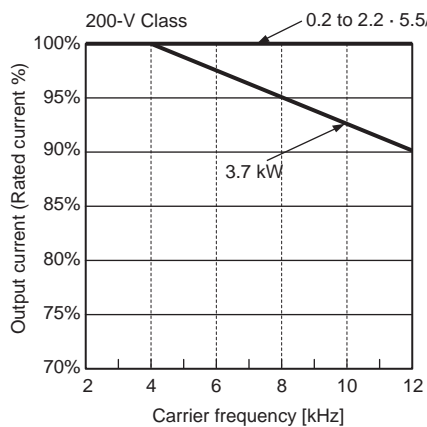

2-1 Installation

- Before installing the Inverter, place a cover over all the ventilation openings to shield them from foreign objects.
After completing the installation process, be sure to remove the covers from the Inverter before operation.

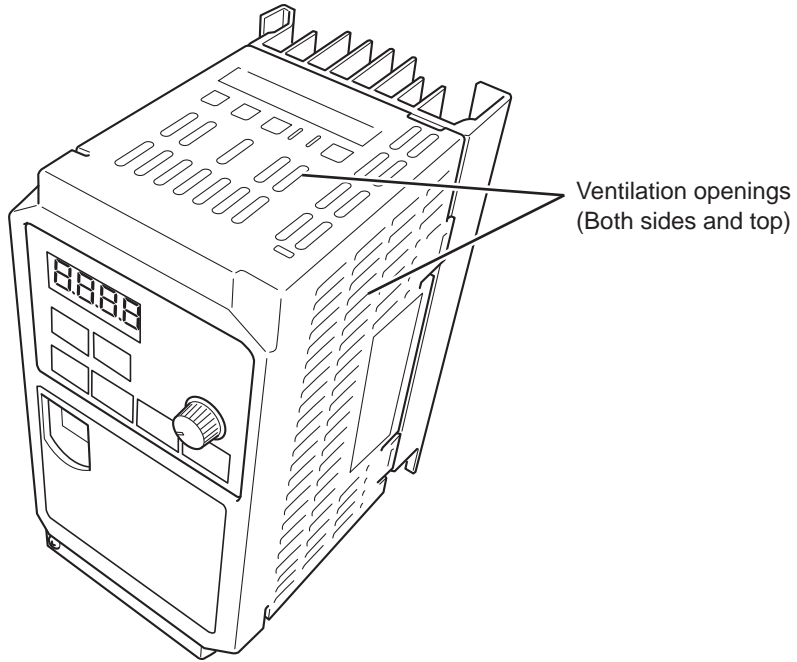

2-2 Wiring

Removing and Mounting the Front Cover

■ Removing the Front Cover

Loosen the mounting screw at the lower left of the front cover. Lift the bottom of the front cover to remove while holding the body.

1. Loosen the front cover mounting screw.

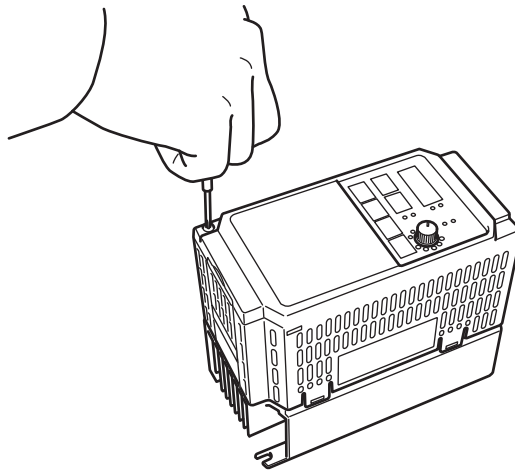

2. Lift the bottom of the front cover to remove.

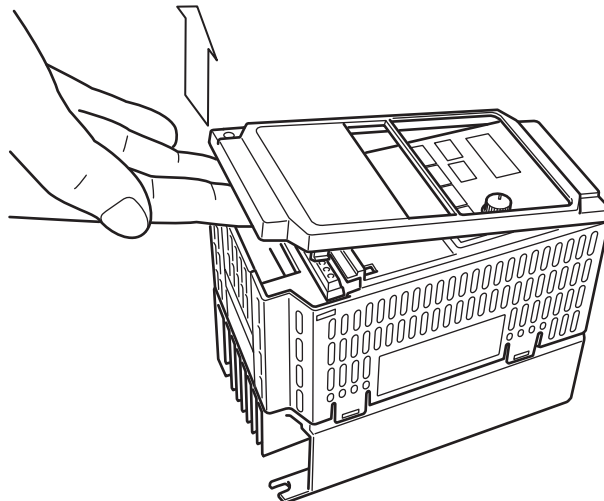

■ **Mounting the Front Cover**

Hang the upper side of the front cover on the hooks, and push down both sides of the cover simultaneously until it clicks into place.

1. Hang the upper side on the hooks. (Two hooks)

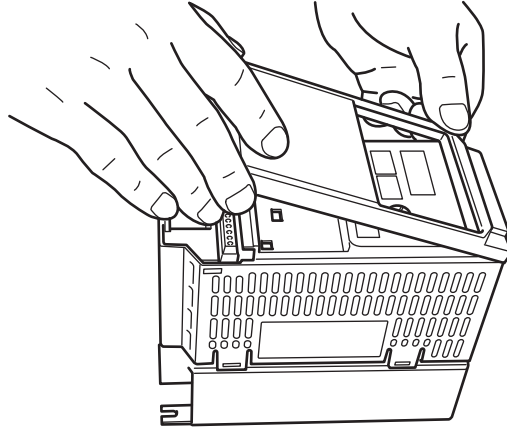

2. Push down the cover until it clicks into place. (Both sides)

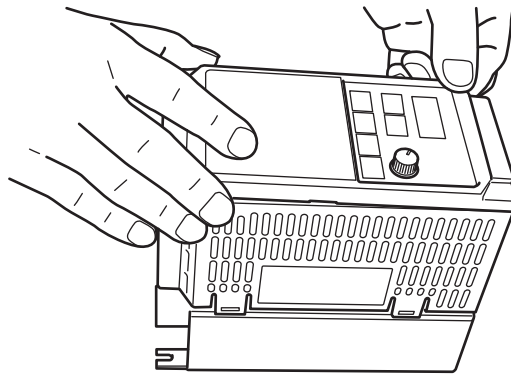

Standard Connection Diagram

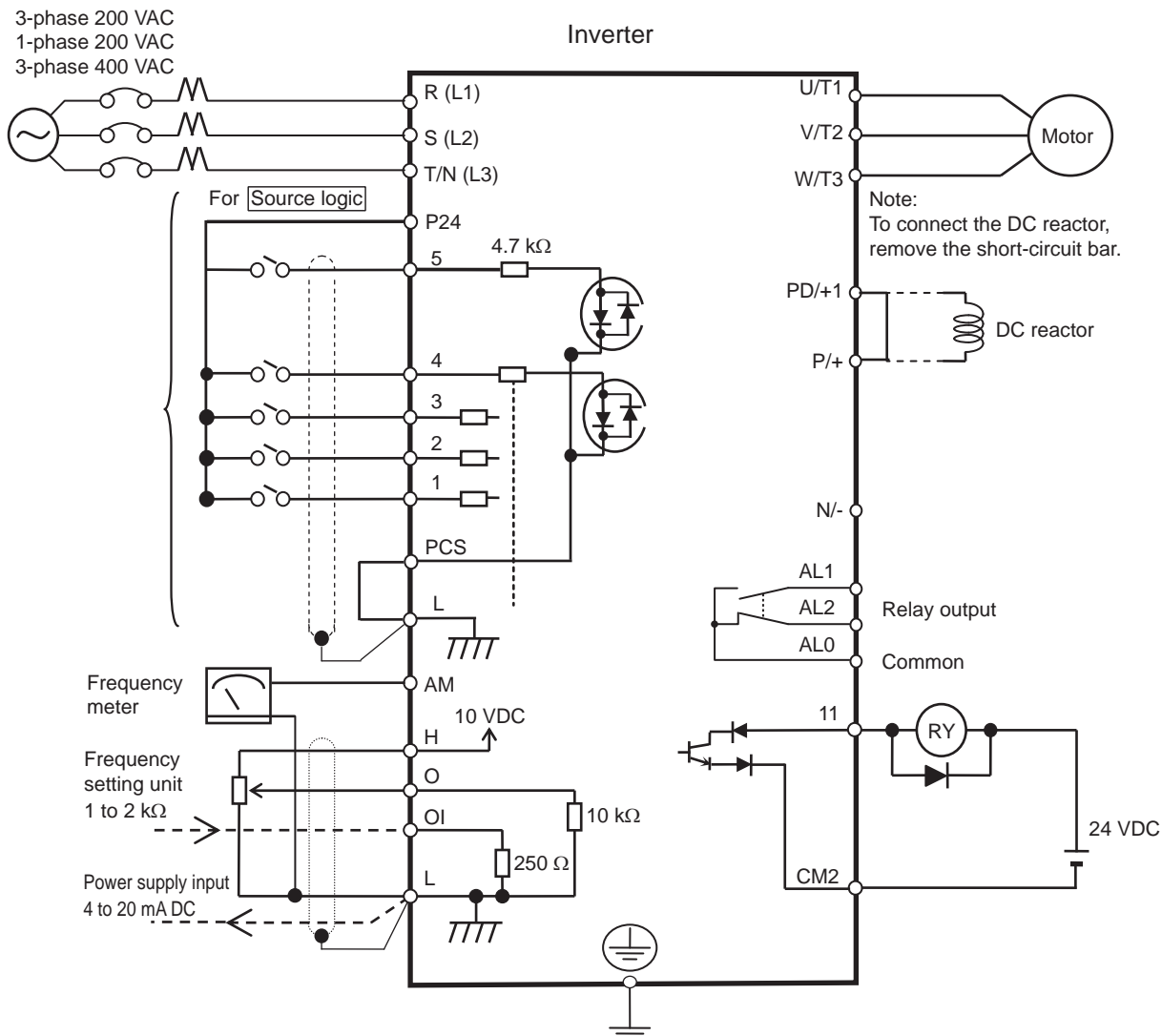

Different terminals have different commons.

Terminals	1, 2, 3, 4, 5	AM	H, O, OI	11
Commons	Sink logic - L	L		CM2
	Source logic - P24			

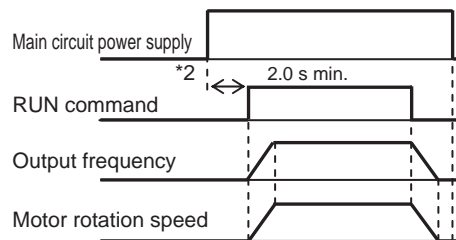

*1.) Use terminals L1 and N for single phase model 3G3JX-AB□□□

*2.) If the main circuit is turned on at the same time as a RUN command is input, the motor begins to rotate at least 2.0 seconds later.

Secure a duty cycle of 5 minutes or more between switching the power ON/OFF. Otherwise, the life of the Inverter is shortened.

Do not turn off the main circuit during operation.

Wiring to the Power Supply and Motor

(Example) 3G3JX-A2004

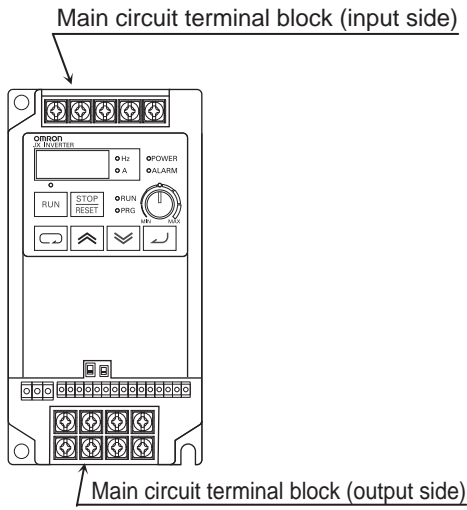

(Example) 3G3JX-A2037

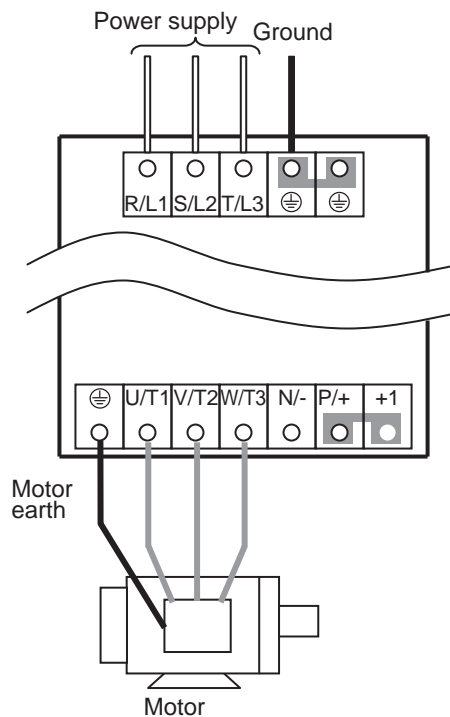
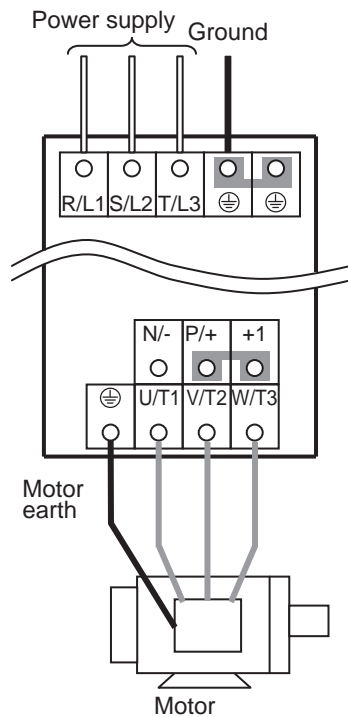
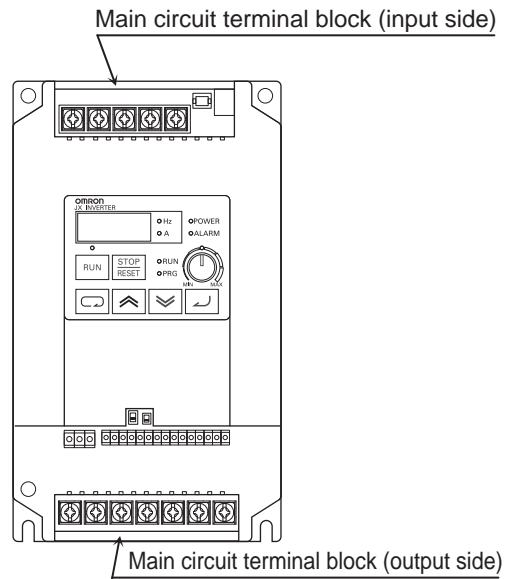

- Do not connect the power supply other than to R/L1, S/L2, or T/L3.
- Do not remove the short-circuit bar between P/+2 and +1, except when a DC reactor is connected.

Note 1: Install an earth leakage breaker on the power supply input side.
 (Select an earth leakage breaker having a higher sensed leakage current and avoid unnecessary operation.)
 If the wiring between the Inverter and the motor is too long (longer than 10 m), the motors thermal relay may malfunction due to harmonics. Install an AC reactor on the Inverter output side, or use a current sensor instead of the motors thermal relay.

Note 2: Connect securely to the ground as specified (type-D grounding for 200-V class, and type-C grounding for 400-V class). Do not share the grounding electrode with other strong electrical devices.

Example of incorrect grounding

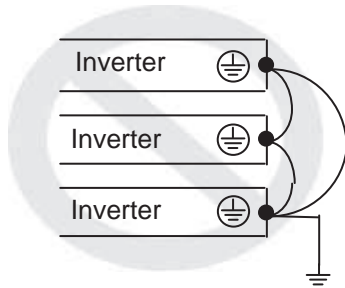

Example of correct grounding

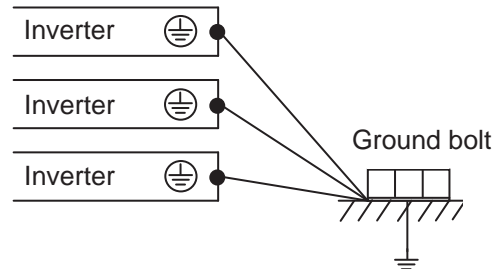

Wiring the Control Circuit Terminals and Relay Terminals

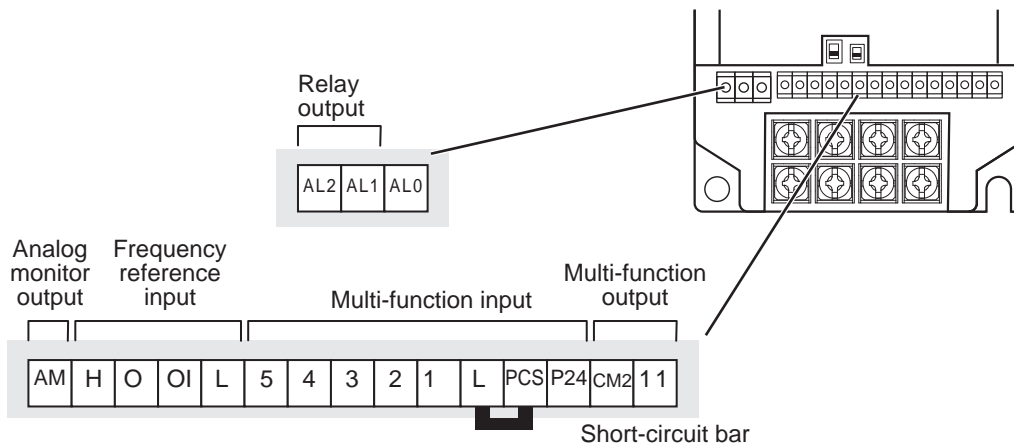

Wiring Example of the Control Circuit Terminal Block (Sink Logic)

At sink logic (NPN) : External power supply input
 At source logic (PNP) : Power supply output
 Note: By factory default, the input logic of the multi-function input terminal circuit is set to the sink logic using internal supply.

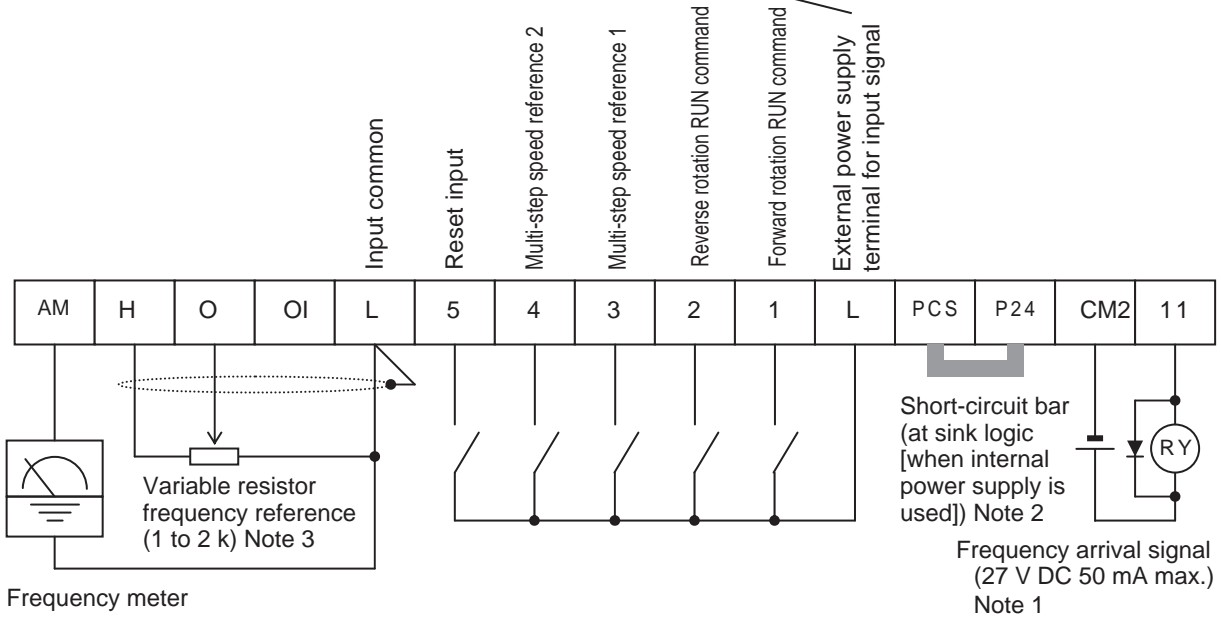

- Note 1: When connecting a relay to the multi-function output terminal, install a surge-absorbing diode in parallel with the relay. The output circuit can break down due to surge voltage when the relay is switched on/off.
- Note 2: Remove the short-circuit bar when the external power supply is used.
- Note 3: For the Analogue signal line, use a twisted shield wire and apply an insulating sleeve to the shield as illustrated below. Keep the length to 20 m or less.

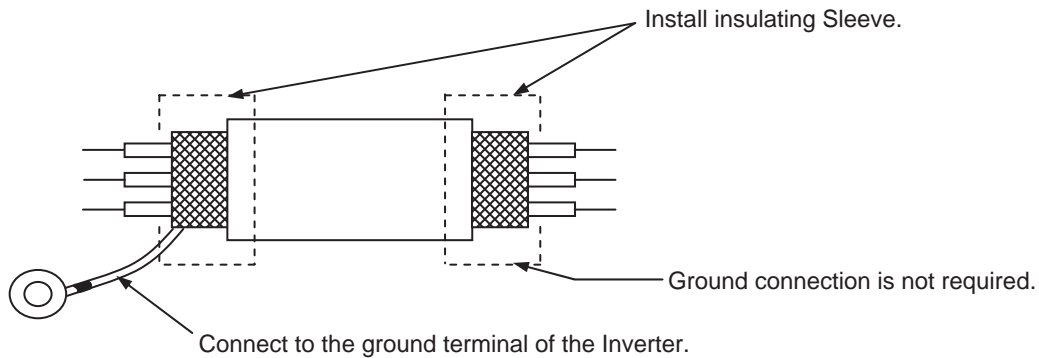

- Note 4: Keep the wiring away from the power cable of the main circuit and from the wiring on the relay control circuit. (More than 10 cm apart)

Selecting the Sequence Input Method (Sink/Source Logic)

Logic Selection Method for the Multi-function Input Terminals

When the internal power supply is used, you can switch the logic by rearranging the short-circuit bar on the control circuit terminal block. The default setting is sink logic.

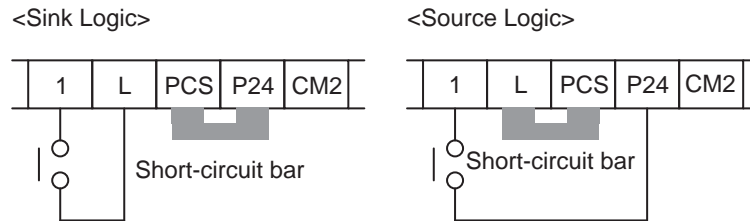

Note 1: Remove the short-circuit bar when the external power supply is used.

	Inside the Inverter When Internal interface power supply is used	When external power supply is used
Sink logic		
Source logic		

Wiring the Main Circuit Terminals

■Connecting the Main Circuit Terminals

Motor output (kW)	Applicable Inverter model	Wiring	Applicable device	
		Power cable	Earth leakage breaker (ELB)	Fuse size (class J) Rated 600 V
0.2	3G3JX-A2002	1.25 mm ²	5 A	10 A
0.4	3G3JX-A2004	1.25 mm ²	5 A	10 A
	3G3JX-A4004			3 A
0.75	3G3JX-A2007	2.0 mm ²	10 A	15 A
	3G3JX-A4007	1.25 mm ²	5 A	6 A
1.5	3G3JX-A2015	2.0 mm ²	15 A	15 A
	3G3JX-A4015	2.0 mm ²	10 A	10 A
2.2	3G3JX-A2022	2.0 mm ²	20 A	20 A
	3G3JX-A4022	2.0 mm ²	10 A	10 A
3.7	3G3JX-A2037	3.5 mm ²	30 A	30 A
	3G3JX-A4040	2.0 mm ²	15 A	15 A
5.5	3G3JX-A2055	5.5 mm ²	50 A	40 A
	3G3JX-A4055	3.5 mm ²	30 A	20 A
7.5	3G3JX-A2075	8.0 mm ²	60 A	50 A
	3G3JX-A4075	3.5 mm ²	30 A	25 A
0.2	3G3JX-AB002	2.0 mm ²	5A	14 A
0.4	3G3JX-AB004	2.0 mm ²	5 A	—
0.75	3G3JX-AB007	2.0 mm ²	10 A	—
1.5	3G3JX-AB015	5.5 mm ²	15 A	—
2.2	3G3JX-AB022	5.5 mm ²	20A	—

- For the main circuit terminals, always use insulated electrical wires with a rated voltage of 600 V and a rated temperature of 80°C or higher.
- Use the crimp-type terminal with an insulating sleeve to connect to the terminals.
- Up to two wires can be connected to one terminal.
- To prevent possible voltage drops, increase the wire size in accordance with the cable length.
- To connect the 200-V model to the relay output terminal block, use a wire of 0.75 mm².
- To connect seven wires or more to the control circuit terminal block, use a shield line of 0.5 mm² or less.
- Strip the signal line by 5 to 6 mm, and connect the exposed wire. (In the case of stranded wires, make sure that the wires are not unraveled.)
- Make sure that the maximum outside diameter of the signal cable is 2.0 mm or less (except for the alarm signal cable). (For cable and multi-core cable fitted with cable markers, keep both the cable markers and the sheath-stripped length 40 mm or more from the connecting end. As a thick cables may prevent proper closing of the terminal block cover.)
- To meet UL standards, always insert a UL-standard fuse (J type) on the power supply side.
- Use a ground wire with a larger diameter than that of the power cable shown above.

Choose the sensitivity current of the earth leakage breaker (ELB), depending on the total distance (L) between the Inverter and the power supply, and the Inverter and the motor.

For models with build-in filter a time delay ELB could be necessary in some cases.



L	Sensitivity current (mA)
100 m max.	30
300 m max.	100
800 m max.	200

Guide of leakage current: If a CV wire is used and routed through a metal pipe, the leakage current is 30 mA/km.

Due to the higher specific inductive capacity of the H-IV wire, the leakage current increases about eight times. Use a wire with a sensitivity current one-level higher.

The leakage current mentioned here is the effective value of the fundamental wave, and high-frequency currents are excluded.

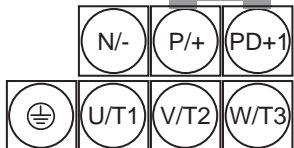
Terminal Arrangement

Main circuit terminal block	Model (3G3JX-)	Screw size	W (mm)
<p>Upper side of the body</p>  <p>Lower side of the body</p> 	A2002 to A2007 AB002 to AB004 (*1)	M3.5	7.1
<p>Upper side of the body</p>  <p>Lower side of the body</p> 	A2015 to A2037 A4004 to A4040 AB007 to AB022 (*1)	M4	9.2
	A2055 to A2075 A4055 to A4075	M5	13

*1. For 3G3JX-AB□□□, R/L1 corresponds to L1 and T/L3 to N, terminal S/L2 is not available. Connect a single-phase 200-V AC input to terminals L1 and N.

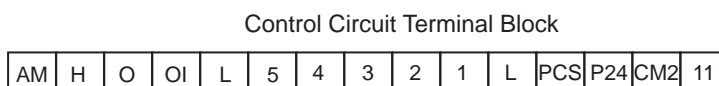
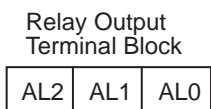

Model (3G3JX-)	A2002 to A2007 AB002 to AB004		A2015 to A2037 A4004 to A4040 AB007 to AB022		A2055 to A2075 A4055 to A4075	
	Screw size	W (mm)	Screw size	W (mm)	Screw size	W (mm)
Main circuit	M3.5	7.1	M4	9.2	M5	13
Control circuit	M2	—	M2	—	M2	—
Relay	M2.5	—	M2.5	—	M2.5	—
Ground	M4	—	M4	—	M5	13

Screw Tightening Torque

Screw	Tightening torque
M2	0.2 N•m (max. 0.25 N•m)
M2.5	0.5 N•m (max. 0.6N•m)
M3.5	0.8 N•m (max. 0.9 N•m)
M4	1.2 N•m (max. 1.3 N•m)
M5	3.0 N•m (max. 3.3 N•m)

■ Explanation of the Main Circuit Terminal Connection

Terminal symbol	Terminal name	Function	Connection example
R/L1, S/L2, T/L3 *	Main power supply input terminal	Connect the input power supply.	<p style="text-align: center;">Power supply</p>
U/T1, V/T2, W/T3	Inverter output terminal	Connect to the motor.	
PD/+1, P/+	External DC reactor terminal	Normally connected by the short-circuit bar. Remove the short-circuit bar between PD/+1 and P/+ when a DC reactor is connected.	
P/+, N/-	Regenerative braking unit connection terminal	Connect optional regenerative braking units.	
⊕	Ground terminal	Ground (Connect to ground to prevent electric shock and reduce noise.)	

* For 3G3JX-AB□□□'s terminal symbols, R/L1 corresponds to L1, S/L2 to L2, and T/L3 to N/L3. Connect a single-phase 200-V AC input to terminals L1 and N.

■ Main Circuit Connection Diagram

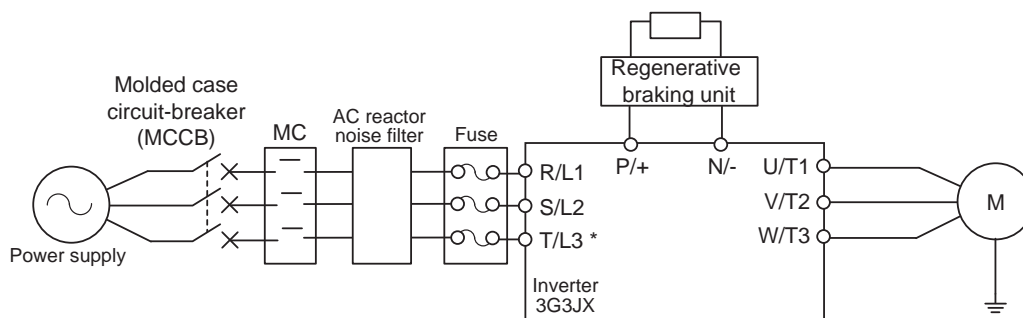

* For 3G3JX-AB□□□'s terminal symbols, R/L1 corresponds to L1 and T/L3 to N.

■ Wiring the Main Circuit Terminals (Input Side)

Installing a Molded-case Circuit Breaker (MCCB)

- Always connect the Inverter and power supply via a molded-case circuit breaker (MCCB) to protect the Inverter from damage that may result from short-circuiting.
- Always connect the power input terminals (R/L1, S/L2, and T/L3) and power supply via an MCCB, according to the Inverter capacity.
- Install one MCCB per Inverter.
- Choose an appropriate MCCB capacity according to the fuse size on page 2-14.
- When choosing MCCB's time characteristics, be sure to consider the Inverter's overload protection (1 minute at 150% of the rated output current).
- By programming the sequence as illustrated below, you can turn off the power via the relay outputs (AL2, AL1, and AL0) for the 3G3JX Series.

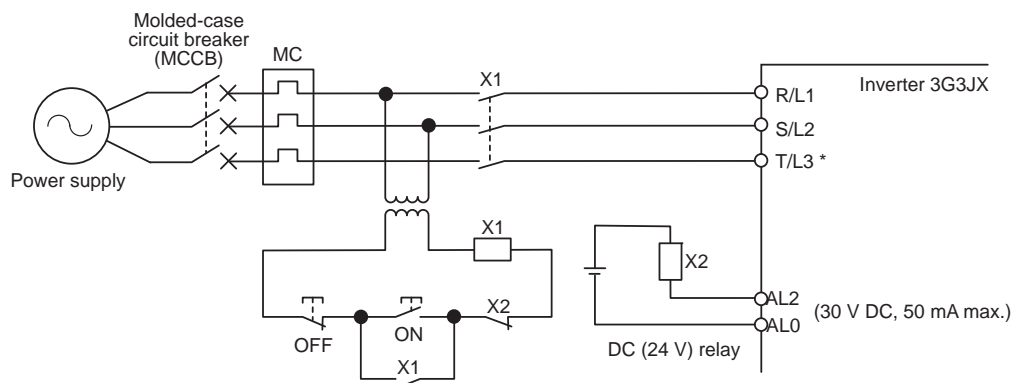

* For 3G3JX-AB□□□'s terminal symbols, R/L1 corresponds to L1 and T/L3 to N.

Installing a Ground Fault Interrupter

- The Inverter's output uses high-speed switching, and so generates high-frequency current leakage. (Generally, if the power cable is 1 m, the leakage current is approx. 100 mA per Inverter, and approx. 5 mA is added per additional meter of the power cable.)
- At the power supply input part, install a special-purpose ground fault interrupter for Inverters that excludes high-frequency leakage current and detects only the leakage current within a frequency range that is hazardous to humans. (Choose a ground fault interrupter with a sensitivity current of at least 10 mA per Inverter or bigger one if build-in filter or a external filter is used.)
- Alternatively, use a general ground fault interrupter with a sensitivity current of 200 mA or more per Inverter, and with an operating time of 0.1 s or more.

Installing a Magnetic Contactor (MC)

- If the power supply of the main circuit is shut off due to sequencing, a magnetic contactor (MC) can be used. (When forcibly stopping the load with an MC on the primary side of the main circuit, however, the regenerative braking does not work and the load coasts to a stop (free run).)
- Frequently opening and closing the magnetic contactor (MC) to start and stop a load may cause damage to the Inverter. To extend the life of the Inverter's internal electrolytic capacitor, limit the frequency to no more than once every 30 minutes.

Connection Sequence to the Terminal Block

- Input power supply can be connected to any terminal because the phase sequence of the input power supply is irrelevant to that of the terminal block (R/L1, S/L2, and T/L3).

Installing an AC Reactor

- If the Inverter is connected to a large-capacity power transformer (660 kVA or more) or the phase advance capacitor is in use, a large peak current may flow through the input power circuit, causing damage to the converter unit.
- Install an optional AC reactor on the input side of the Inverter. An AC reactor will also improve the power factor of the power input side.

Installing a Surge Absorber

- Always use a surge absorber or diode when magnetic contactors (MC), electromagnetic relays, solenoid valves, solenoid, and magnetic brakes are used.

Installing a EMC Filter on the Input Side

- The Inverter's output uses high-speed switching, so noise may be transmitted from the Inverter to the power line, affecting peripheral devices.
- It is recommended that a noise filter be installed on the input side to minimize noise transmission. (Installing a noise filter on the input side can also reduce the noise from the power line to the Inverter.)

Recommended Input Filters for the Inverter

EMC-conforming
AX-FIJ

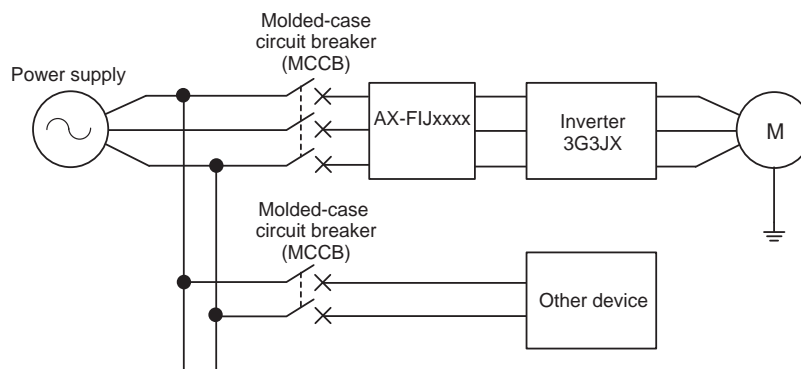

- * Use the recommended noise filter for each inverter. A general-purpose noise filter will be less effective and may not reduce noise.

■Wiring the Main Circuit Terminals (Output Side)

Connect the Terminal Block to the Load

- Connect motor output terminals U/T1, V/T2, and W/T3 to motor lead wires U, V, and W.
- Check that the motor rotates forward with the forward command. Switch over any two of the output terminals (U/T1, V/T2, W/T3) and reconnect if the motor rotates in reverse to the forward command.

Never Connect a Power Supply to the Output Terminals

- If voltage is applied to the output terminals, the internal circuit of the Inverter will be damaged. Never connect a power supply to output terminals U/T1, V/T2, or W/T3.

Never Short-circuit or Ground the Output Terminals

- Never touch the output terminals by hand.
- If the output wires come into contact with metal materials, an electric shock or ground fault will occur. This is extremely hazardous. Be careful not to short-circuit the output wires.

Do Not Use a Phase Advance Capacitor or Noise Filter

- Doing so may result in damage to the Inverter or cause the parts to burn. Never connect a phase advance capacitor or LC/RC noise filter to the output circuit.

Do Not Use an Electromagnetic Switch

- If a load is connected to the Inverter during running, an inrush current will actuate the overcurrent protective circuit in the Inverter. Do not connect an electromagnetic switch or magnetic contactor (MC) to the output circuit.

Install a Noise Filter on the Output Side

Connect a noise filter to the output side of the Inverter to reduce induction and radio noise.

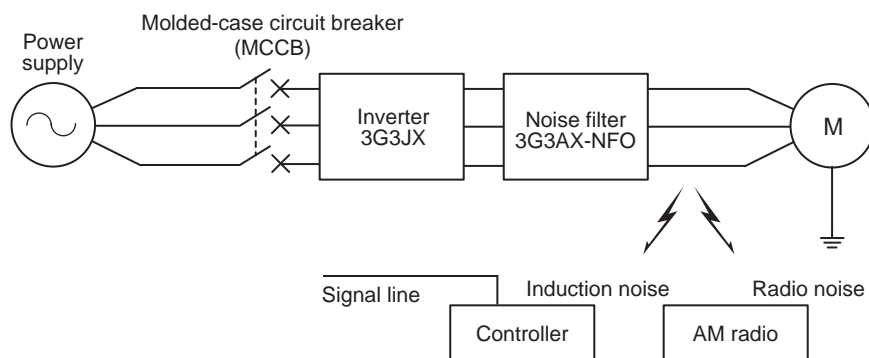

Induction noise: Electromagnetic induction can generate noise on the signal line, causing the controller to malfunction.

Radio noise: Electromagnetic waves from the Inverter and I/O cables can cause the radio receiver to generate noise.

Countermeasures Against Induction Noise

To reduce induction noise from the output side, the following method is also effective.

- Run the cables collectively through the mounted metal pipe. Keeping the metal pipe at least 30 cm away from the signal line reduces induction noise.

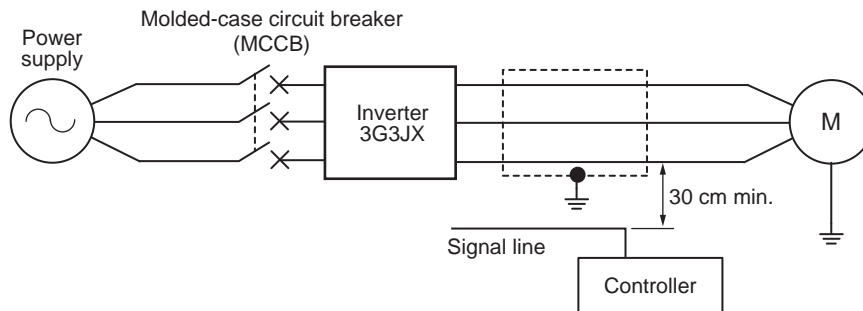

Cable Length Between Inverter and Motor

Use a cable of 50 m or less between the Inverter and the motor. If the cable length is increased, the stray capacitance between the Inverter outputs and the ground is increased proportionally. An increase in stray capacitance causes high-frequency leakage current to increase, affecting the current detector in the Inverter's output unit and peripheral devices. If your system configuration requires a cable length of 50 m or more, perform the following:

- Wire in metallic ducts.
- Use separate cables for each phase to reduce cable capacitance.
- Set the Inverter to a lower carrier frequency (b083).

Do Not Use Single-phase Motors

- A single-phase motor uses the capacitor start method or split-phase start method to determine its rotation direction at startup, and thus is not suitable for the variable speed control via the Inverter. Do not use single-phase motors.
- * If a capacitor start motor is used, the capacitor may be damaged by a sudden electric charge and discharge caused by Inverter output. If a split-phase start motor is used, the startup coil may burn because the centrifugal switch does not operate.

■ Specifications of the Control Circuit Terminals

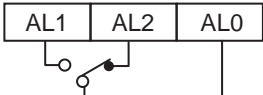
	Terminal symbol	Terminal name and function	Default setting	Specifications
Input signal	PCS	External power supply terminal for input signal (input).....At sink logic	—	24 V DC ±10% 30 mA max.
		Internal power supply output terminal for input signal (output).....At source logic		24 V DC ±10% 100 mA max.
	1	Multi-function input terminals 1 to 5 Select 5 functions among the 31 functions and allocate them to from terminals 1 to 5.	Forward/Stop	Contact input Close: ON (Start) Open: OFF (Stop)
	2		Reverse/Stop	
	3		Fault reset	
	4	The terminal allocation is changed automatically when the emergency shutoff function is used. Refer to "Emergency Shutoff Input Function" (page 4-46).	Emergency stop fault	Minimum ON time: 12 ms min.
	5		Multi-step speed reference 1	
L	Input signal common	—		
Monitor signal	AM	Analog frequency monitor/ Analog output current monitor	Analog frequency monitor	
Frequency reference input	H	Frequency reference power supply	—	10 V DC 10 mA max.
	O	Voltage frequency reference signal	—	0 to 10 V DC Input impedance 10 kΩ When installing variable resistors at FS, FV, and FC (1 to 2 kΩ)
	OI	Current frequency reference signal	—	4 to 20 mA DC Input impedance 250 Ω
	L	Frequency reference common	—	
Output signal	11	Multi-function output terminal Select the status of the Inverter and allocate it to terminal P1.	Frequency arrival signal at a constant speed	27 V DC 50 mA max.
	CM2	Output signal common	—	
Relay output signal	AL2	 <p>Under normal operation : AL2-AL0 Closed Under abnormal operation or power shutdown : AL2-AL0 Open (Default)</p>	<p>Contact ratings</p> <p>250 V AC 2.0 A (resistance load) 100 V AC min. 0.2 A (inductive load) 10 mA</p> <p>30 V DC 3.0 A (resistance load) 5 V DC 0.6 A (inductive load) 100 mA</p>	
	AL1			
	AL0			

■ Functions and Connections of the Control Circuit Terminals

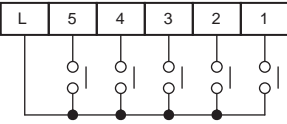
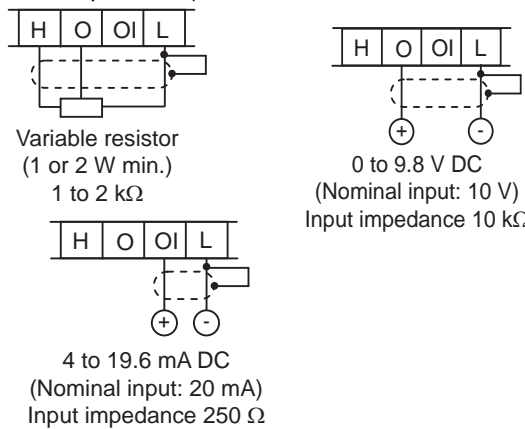
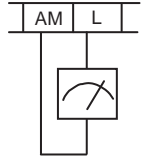
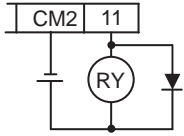
Terminal function	Terminal symbol	Terminal name	Function and connecting method	Wire size
Contact input (for switching function)	1 2 3 4 5	Multi-function input	Select functions and allocate them to terminals 1 to 5. (The figure below illustrates the wiring of the sink logic.) 	
Power supply	P24	Internal 24 V DC	24 V DC output	
	L	Input common	Input signal common	
	PCS	Input power supply	If the multi-function input is set as the sink logic, the PCS terminal acts as an external power supply input terminal. If the multi-function input terminal is set as the source logic, the PCS terminal acts as an internal power supply output terminal.	
External analog frequency reference	H	Frequency reference power supply output	<ul style="list-style-type: none"> External voltage directive is 0 to 9.8 V. (Nominal input: 10 V) *1  <p>Variable resistor (1 or 2 W min.) 1 to 2 kΩ</p> <p>0 to 9.8 V DC (Nominal input: 10 V) Input impedance 10 kΩ</p> <p>4 to 19.6 mA DC (Nominal input: 20 mA) Input impedance 250 Ω</p>	Shield wire of 0.14 to 0.75 mm ² Recommended wire size: 0.75 mm ²
	O *3	Frequency reference Input (Voltage directive)		
	OI *4	Frequency reference Input (Current directive)		
	L	Frequency reference common		
Monitor output	AM	Multi-function analog output	<ul style="list-style-type: none"> Choose from frequency or output current. Output terminal specifications 0 to 10 V DC full-scale 1 mA max. 	
Open Collector Output	11	Multi-function output *2	 <p>Output terminal specifications Between each terminal and PC the voltage drop is 4V max. at power-on Open collector output 27 V DC max. 50 mA max. Select the status of the Inverter and allocate it to terminal 11.</p>	
	CM2	Multi-function output common		
Relay output	AL2 AL1	Relay output	Selection of functions is the same as the multi-function output. *5 *6	
	AL0	Relay output common		

*1. Simultaneous input of current and voltage is not possible. Do not connect the signal lines simultaneously.

*2. By factory default, multi-function output 11 is set to NO contact. To switch to NC contact, change the C031 setting.

*3. Do not input negative voltage. Doing so may result in damage to the inverter

- *4. For the external analog input indicated above, use a shielded wire for connection and connect the shielded part to terminal L for stable operation.
- *5. Below are the contact specifications of the relay output.

Output terminal	Contact capacity	Resistance load	Inductive load
AL2-AL0	Max.	250 V AC 2.5 A 30V DC 3 A	250 V AC 0.2 A 30 V DC 0.7 A
	Min.	100 V AC 10 mA 5 V DC 100 mA	
AL1-AL0	Max.	250 V AC 1 A 30 V DC 1 A	250 V AC 0.2 A 30 V DC 0.2 A
	Min.	100 V AC 10 mA 5 V DC 100 mA	

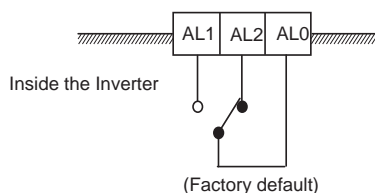

- *6. By factory default, the relay output (AL2, AL1) contact selection (C036) is set at NC contact between AL2-AL0, and NO contact between AL1-AL0.

■ Mode Selector

RS-485 Communication/Operator Selector (S7)

Select the mode according to the option connected to the communications connector. When using the 3G3AX-OP01 supplied with the Inverter, it is available regardless of the switch condition.

Symbol	Name	Status	Description
S7	RS-485 communication/ operator selector	485	RS485 ModBus communication
		OPE [Default]	Digital Operator (Option: 3G3AX-OP1)

Emergency shutoff selector (S8)

Use this selector to enable the emergency shutoff input function.

Symbol	Name	Status	Description
S8	Emergency shutoff selector	ON	Emergency shutoff input enabled ^{*1}
		OFF [Default]	Normal

- *1 The multi-function input terminal 3 is switched to a terminal for emergency shutoff input, and the allocation of other multi-function input terminals is also changed automatically. Do not set to ON immoderately. For details, refer to "Emergency Shutoff Input Function" (page 4-46).

Conforming to EC Directives

■ Conforming Standards

- EMC directive EN 61800-3
- Low-voltage directive EN 61800-5-1

■ Concept of Conformity

EMC Directive

OMRON products are the electrical devices incorporated and used in various machines or manufacturing equipment. For this reason, we make efforts to conform our products to their related EMC standards so that the machines or equipment which have incorporated our products should easily conform to the EMC standards. The 3G3JX models have conformed to the EMC directive EN 61800-3 by following the installation and wiring method as shown below. Your machines or equipment, however, vary in type, and in addition, EMC performance depends on the configuration, wiring, or location of the devices or control panels which incorporate the EC directive conforming products. This in turn does not allow us to confirm the condition and the conformity in which our products are used. Therefore, we appreciate confirmation of the final EMC conformity for the whole machine or equipment on your own.

Wiring the Power Supply

- Be sure to connect the power input terminals (R/L1, S/L2, and T/L3) and power supply via an EMC conforming dedicated noise filter AX-FIJ□□ for the none integrated filter models. The single phase 3G3JX-AB□□□-F and three-phase 400V 3G3JX-A4□□□-F models have integrated filter complies to EN61800-3 as shown below.

Model	EMC requirements	LVD requirements	Carrier freq	Motor cable
single phase 200V	EN61800-3 category C1	EN61800-5-1:2003	3KHz	5m (shielded)
3-phase 400V	EN61800-3 category C3			

- Keep the ground cable as short as possible.
- Keep the cable between the Inverter and the noise filter as short as possible.

Low-voltage Directive

The 3G3JX models have conformed to the EMC directive EN61800-5-1 by performing the machine installation and wiring as shown below.

- The 3G3JX models are an open type device. Be sure to install it inside the control panel.
- The power supply and voltage (SELV) with reinforced or double insulation should be used for wiring to the control circuit terminals.
- To satisfy requirements of the LVD (low-voltage) directive, the Inverter must be protected with a molded case circuit breaker (MCCB) in case a short-circuiting accident occurs. Be sure to install a molded case circuit breaker (MCCB) on the power supply side of the Inverter.
- Use one molded case circuit breaker (MCCB) per Inverter.
- Use the crimp-type terminal with an insulation sleeve to connect to the main circuit terminals.
- When not using the braking resistor or braking resistor unit, connect the crimp-type terminal with an insulation sleeve to the braking resistor connection terminals (P/+, N/-).

Important notes

- Input choke is required to comply with EMC directive from the harmonic distortion point of view (IEC 61000-3-2 and 4).
- If the motor cable length exceeds 5m, use output choke to avoid unexpected problem due to the leakage current from the motor cable.

- Integrated EMC filter contains Y-capacitors connected to earth. That means the leakage current from the Y-capacitors may effect on the Earth Leakage Breaker (ELB) at input side. Please refer to the following table to help selecting ELB. Note that the values are nominal ones only flow via the capacitor. Leakage current from the motor cable and motor should also be considered when selecting the ELB. Actual value may be different depending on your system.

Model	Earth leakage current @50Hz 200V [mA rms]	
	Neutral point earthed	One phase earthed
3G3JX-AB002~AB004-F	4.2	-
3G3JX-AB007~AB022-F	8.3	-

Model	Earth leakage current @50Hz 400V [mA rms]	
	Neutral point earthed	One phase earthed
3G3JX-A4004~A4040-F	3.6	8.7
3G3JX-A4055~A4075-F	35.7	80.4

The values are almost proportional to the input voltage.

- As user you must ensure that the HF (high frequency) impedance between adjustable frequency inverter, filter, and ground is as small as possible.
 - Ensure that the connections are metallic and have the largest possible contact areas (zinc-plated mounting plates).
- Avoid conductor loops that act like antennas, especially loops that encompass large areas.
 - Avoid unnecessary conductor loops.
 - Avoid parallel arrangement of low-level signal wiring and power-carrying or noise-prone conductors.
- Use shielded wiring for the motor cable and all analog and digital control lines.
 - Allow the effective shield area of these lines to remain as large as possible; i.e., do not strip away the shield (screen) further away from the cable end than absolutely necessary.
 - With integrated systems (for example, when the adjustable frequency inverter is communicating with some type of supervisory controller or host computer in the same control cabinet and they are connected at the same ground + PE-potential), connect the shields of the control lines to ground + PE (protective earth) at both ends. With distributed systems (for example the communicating supervisory controller or host computer is not in the same control cabinet and there is a distance between the systems), we recommend connecting the shield of the control lines only at the end connecting to the adjustable frequency inverter. If possible, route the other end of the control lines directly to the cable entry section of the supervisory controller or host computer. The shield conductor of the motor cables always must connected to ground + PE at both ends.
 - To achieve a large area contact between shield and ground + PE-potential, use a PG screw with a metallic shell, or use a metallic mounting clip.
 - Use only cable with braided, tinned copper mesh shield (type "CY") with 85% coverage.
 - The shielding continuity should not be broken at any point in the cable. If the use of reactors, contactors, terminals, or safety switches in the motor output is necessary, the unshielded section should be kept as short as possible.
 - Some motors have a rubber gasket between terminal box and motor housing. Very often, the terminal boxes, and particularly the threads for the metal PG screw connections, are painted. Make sure there is always a good metallic connection between the shielding of the motor cable, the metal PG screw connection, the terminal box, and the motor housing. If necessary, carefully remove paint between conducting surfaces.





- Take measures to minimize interference that is frequently coupled in through installation cables.
 - Separate interfering cables with 0.25 m minimum from cables susceptible to interference. A particularly critical point is laying parallel cables over longer distances. If two cables intersect (one crosses over the other), the interference is smallest if they intersect at an angle of 90°. Cables susceptible to interference should therefore only intersect motor cables, intermediate circuit cables, or the wiring of a rheostat at right angles and never be laid parallel to them over longer distances.
- Minimize the distance between an interference source and an interference sink (interference-threatened device), thereby decreasing the effect of the emitted interference on the interference sink.
 - You should use only interference-free devices and maintain a minimum distance of 0.25 m from the adjustable frequency inverter.
- Follow safety measures in the filter installation.
 - If using external EMC filter, ensure that the ground terminal (PE) of the filter is properly connected to the ground terminal of the adjustable frequency inverter. An HF ground connection via metal contact between the housings of the filter and the adjustable frequency inverter, or solely via cable shield, is not permitted as a protective conductor connection. The filter must be solidly and permanently connected with the ground potential so as to preclude the danger of electric shock upon touching the filter if a fault occurs.
- To achieve a protective ground connection for the filter:
 - Ground the filter with a conductor of at least 10 mm² cross-sectional area.
 - Connect a second grounding conductor, using a separate grounding terminal parallel to the protective conductor. (The cross section of each single protective conductor terminal must be sized for the required nominal load.)

Chapter 3



Operation

3-1	Test Run Procedure	3-3
3-2	Test Run Operation	3-4
3-3	Part Names and Descriptions of the Digital Operator	3-8
3-4	Operation Procedure (Example: Factory Default)	3-10
3-5	Parameter Transition	3-16
3-6	Parameter List	3-17

WARNING

	Do not remove the front cover during the power supply and 5 minutes after the power shutoff. Doing so may result in a serious injury due to an electric shock.
	Do not operate the Digital Operator or switches with wet hands. Doing so may result in a serious injury due to an electric shock.
	Inspection of the Inverter must be conducted after the power supply has been turned off. Not doing so may result in a serious injury due to an electric shock. The main power supply is not necessarily shut off even if the emergency shutoff function is activated.
	Do not change wiring, mode change switches (S7, S8), optional devices or replace cooling fans while the input power is being supplied. Doing so may result in a serious injury due to an electric shock.

CAUTION

	Do not touch the Inverter fins, braking resistors and the motor, which become too hot during the power supply and for some time after the power shutoff. Doing so may result in a burn.
	Take safety precautions such as setting up a molded-case circuit breaker (MCCB) that matches the Inverter capacity on the power supply side. Not doing so might result in damage to property due to the short circuit of the load.

■ Operation and Adjustment

Safety Information

- Be sure to confirm the permissible range of motors and machines before operation because the Inverter speed can be changed easily from low to high.
- Provide a separate holding brake if necessary.

Precautions for Use

■ Error Retry Function

- Do not come close to the machine when using the error retry function because the machine may abruptly start when stopped by an alarm.
- Be sure to confirm the RUN signal is turned off before resetting the alarm because the machine may abruptly start.



■ Non-Stop Function at Momentary Power Interruption

- Do not come close to the machine when selecting restart in the non-stop function at momentary power interruption selection (b050) because the machine may abruptly start after the power is turned on.

■ Operation Stop Command

- Provide a separate emergency stop switch because the STOP key on the Digital Operator is valid only when function settings are performed.
- When checking a signal during the power supply and the voltage is erroneously applied to the control input terminals, the motor may start abruptly. Be sure to confirm safety before checking a signal.

3-1 Test Run Procedure

Item	Description	Reference page																
Installation and Mounting	Install the Inverter according to the installation conditions.	2-2																
	<ul style="list-style-type: none"> •Make sure that the installation conditions are met. 																	
Wiring and Connection	Connect to the power supply and peripheral devices.	2-7																
	<ul style="list-style-type: none"> •Select peripheral devices that meet the specifications, and wire correctly. 																	
Power On	Check the following before turning on the power.																	
	<ul style="list-style-type: none"> •Make sure that an appropriate power supply voltage is supplied and that the power input terminals (R/L1, S/L2, and T/L3) are wired correctly. <ul style="list-style-type: none"> 3G3JX-A2□: 3-phase 200 to 240 V AC 3G3JX-AB□: 1/3-phase 200 to 240 V AC (Connect to L1 and N/L3 for 1 phase) 3G3JX-A4□: 3-phase 380 to 480 V AC •Make sure that the motor output terminals (U/T1, V/T2, and W/T3) are connected to the motor correctly. •Make sure that the control circuit terminals and the control device are wired correctly and that all control terminals are turned off. •Set the motor to no-load status (i.e., not connected to the mechanical system). •After checking the above, turn on the power. 																	
Display Status Check	Make sure that there are no faults in the Inverter.																	
	<ul style="list-style-type: none"> •When the power is turned on normally, the display shows: <table border="0" style="margin-left: 20px;"> <tr> <td>RUN LED indicator</td><td>: ON</td> <td>ALARM LED indicator</td><td>: OFF</td> </tr> <tr> <td>POWER LED indicator</td><td>: ON</td> <td>RUN command LED indicator</td><td>: ON</td> </tr> <tr> <td>Volume LED indicator</td><td>: ON</td> <td>Data LED indicator (frequency)</td><td>: ON</td> </tr> <tr> <td>Data display</td><td>: Displays the set value in d001.</td> <td></td><td></td> </tr> </table> •If an error occurs, the error code is displayed on the data display. In this case, refer to "Chapter 5 Maintenance Operations" and make the necessary changes to remedy. 	RUN LED indicator	: ON	ALARM LED indicator	: OFF	POWER LED indicator	: ON	RUN command LED indicator	: ON	Volume LED indicator	: ON	Data LED indicator (frequency)	: ON	Data display	: Displays the set value in d001.			
RUN LED indicator	: ON	ALARM LED indicator	: OFF															
POWER LED indicator	: ON	RUN command LED indicator	: ON															
Volume LED indicator	: ON	Data LED indicator (frequency)	: ON															
Data display	: Displays the set value in d001.																	
Parameter Initialization	Initialize the parameters.																	
	<ul style="list-style-type: none"> •Set parameter No. b084 to "02", and press the  key while holding down the  and  keys simultaneously. 																	
Parameter Settings	Set the parameters required for a test run.																	
	<ul style="list-style-type: none"> •Set the motor capacity selection (H003) and the motor pole number selection (H004). 																	
No-load Operation	Start the no-load motor via the Digital Operator.																	
	<ul style="list-style-type: none"> •Use the FREQ adjuster on the Digital Operator to rotate the motor. 																	
Actual Load Operation	Connect the mechanical system and operate via the Digital Operator.																	
	<ul style="list-style-type: none"> •If there is no problem with the no-load operation, connect the mechanical system to the motor and operate via the Digital Operator. 																	
Operation	Refer to "Chapter 4 Functions", and set the necessary parameters.																	

3-2 Test Run Operation

Power On

■ Checkpoints Before Turning On the Power

- Make sure that an appropriate power supply voltage is supplied and that the power input terminals (R/L1, S/L2, and T/L3) are wired correctly.
 - 3G3JX-A2□: 3-phase 200 to 240 V AC
 - 3G3JX-AB□: 1-phase 200 to 240 V AC (Connect to L1 and N)
 - 3G3JX-A4□: 3-phase 380 to 480 V AC
- Make sure that the motor output terminals (U/T1, V/T2, and W/T3) are connected to the motor correctly.
- Make sure that the control circuit terminals and the control device are wired correctly and that all control terminals are turned off.
- Set the motor to no-load status (i.e., not connected to the mechanical system).

■ Power On

- After checking the above, turn on the power.

Display Status Check

- When the power is turned on normally, the display shows:

[Normal]	RUN LED indicator (during RUN)	: ON	ALARM LED indicator	: OFF
	POWER LED indicator	: ON	RUN command LED indicator	: ON
	Volume LED indicator	: ON	Data LED indicator (frequency)	: ON
	Data display	: Displays the set value in d001		

- If an error occurs, refer to "Chapter 5 Maintenance Operations" and make the necessary changes to remedy.

[Fault]	RUN LED indicator (during RUN)	: ON	ALARM LED indicator	: ON
	POWER LED indicator	: ON	RUN command LED indicator	: ON
	Volume LED indicator	: ON	Data LED indicator (frequency)	: ON
	Data display	: An error code, such as "E-01", is displayed. (The display varies depending on the type of error.)		













Parameter Initialization

- Initialize the parameters using the following procedure.
- To initialize the parameters, set parameter b084 to "02".

Key sequence	Display example	Description
		Power On
		Press the Mode key once, and then press the Decrement key three times to display "b---".
		Press the Mode key. "b001" is displayed.
		Use the Increment or Decrement key to display "b084".
		Press the Mode key. The set value in "b084" is displayed.
		Use the Increment or Decrement key to display "02".
		Press the Enter key. The set value is entered and "b084" is displayed.
 		Press the STOP/RESET key while holding down the Mode and Decrement keys simultaneously. When the display blinks, release the STOP/RESET key first, and then the Mode and Decrement keys.
		Displays initialization.
(In 1 s)		The parameter number is displayed again in approximately 1 s.

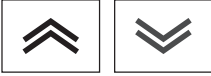
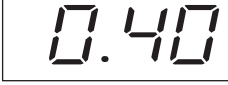
■Setting the Motor Capacity Selection (H003) and Motor Pole Number Selection (H004)







Parameter No.	Register No.	Name	Description	Setting range	Unit of setting	Default setting	Change during RUN
H003	1165h	Motor capacity selection	Sets the capacity of the motor connected to the Inverter.	200-V class 0.2/0.4/0.75/ 1.5/2.2/3.7/ 5.5/7.5 400-V class 0.4/0.75/1.5/ 2.2/3.7/5.5/7.5	kW	Varies with the capacity.	No
H004	1166h	Motor pole number selection	Sets the pole number of the motor connected to the Inverter.	2/4/6/8	Pole	4	No

Key sequence	Display example	Description
		Press the Mode key twice to display the mode selection.
		Use the Increment or Decrement key to display "H---".
		Press the Mode key. "H003" is displayed.
		Press the Mode key. The set value in "H003" is displayed.
		Use the Increment or Decrement key to set the rated motor capacity.
		Press the Enter key. The set value is entered.
(In approx. 1 s)		The parameter number is displayed again.

No-load Operation

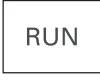
- Start the no-load motor (i.e., not connected to the mechanical system) using the Digital Operator.
- * Before operating the Digital Operator, check that the FREQ adjuster is set to "MIN."
- * Make sure that the LED indicator above the FREQ adjuster and the RUN command LED indicator are lit.

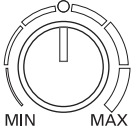
■ Forward/Reverse Rotation via the Digital Operator

Key sequence	Display example	Description
		Press and hold the Mode key for 3 seconds or more to display "d001", and then press again. (Monitors the frequency reference.)
		Press the RUN key. The RUN command LED indicator is lit.
		Turn the FREQ adjuster slowly. The monitor value of the frequency reference is displayed. The motor starts rotating forward in accordance with the frequency reference.

- By turning the FREQ adjuster, make sure that there is no vibration or abnormal sound from the motor.
- Make sure that no errors have occurred in the Inverter during operation.
- Switch between forward and reverse with the operator rotation direction selection (F004).

■ Stopping the Motor

- After completing the no-load operation, press the STOP/RESET key. The motor will stop.

Actual Load Operation

- After checking the operation with the motor in the no-load status, connect the mechanical system and operate with an actual load.
- * Before operating the Digital Operator, check that the FREQ adjuster is set to "MIN."

■ Connecting the Mechanical System

- After confirming that the motor has stopped completely, connect the mechanical system.
- Be sure to tighten all the screws when fixing in the motor axis.

■ Operation via the Digital Operator

- Because a possible error may occur during operation, make sure that the STOP/RESET key on the Digital Operator is easily accessible.
- Use the Digital Operator to operate the Inverter the same way as in no-load operation.

■ Checking the Operating Status

- After making sure that the operating direction is correct and that the Inverter is operating smoothly at a slow speed, increase the frequency reference.
- By changing the frequency reference or the rotation direction, make sure that there is no vibration or abnormal sound from the motor.
Make sure that the output current (output current monitor [d002]) is not excessive.



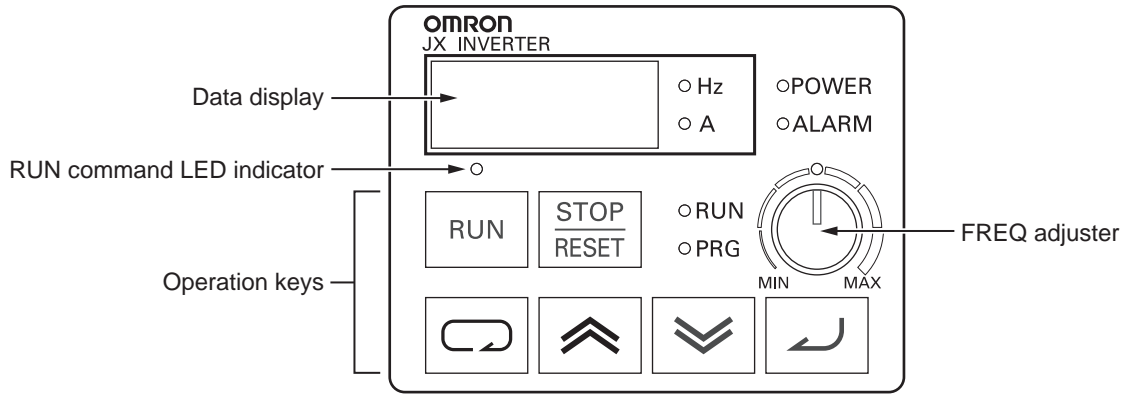

3-3 Part Names and Descriptions of the Digital Operator

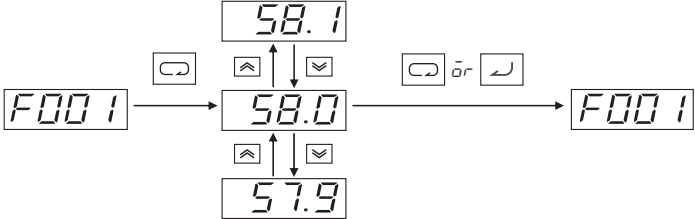

	Name	Description
○POWER	POWER LED indicator	Lit when the power is supplied to the control circuit.
○ALARM	ALARM LED indicator	Lit when an Inverter error occurs.
○RUN	RUN (during RUN) LED indicator	Lit when the Inverter is running.
○PRG	PROGRAM LED indicator	Lit when the set value of each function is indicated on the data display. Blinks during warning (when the set value is incorrect).
	Data display	Displays relevant data, such as frequency reference, output current, and set values.
○ Hz ○ A	Data display LED indicator	Lit according to the indication on the data display. Hz: Frequency A: Current
	Volume LED indicator	Lit when the frequency reference source is set to the FREQ adjuster.
	FREQ adjuster	Sets a frequency. Available only when the frequency reference source is set to the FREQ adjuster. (Check that the Volume LED indicator is lit.)
○	RUN command LED indicator	Lit when the RUN command is set to the Digital Operator. (The RUN key on the Digital Operator is available for operation.)
	RUN key	Activates the Inverter. Available only when operation via the Digital Operator is selected. (Check that the RUN command LED indicator is lit.) Forward/Reverse rotation depends on "F004" setting
	STOP/RESET key	Decelerates and stops the Inverter. Functions as a reset key if an Inverter error occurs.

3
Operation

3-3 Part Names and Descriptions of the Digital Operator

	Name	Description
	Mode key	<p>Switches between: the monitor mode (d□□□), the basic function mode (F□□□), and the extended function mode (A□□□, b□□□, C□□□, H□□□).</p> <p>With this key, you can always change the display as follows.</p> <p>[Supplemental information] To jump to “d001” from any function mode, hold down the Mode key for 3 seconds.</p>  <p>Note: Always press the Enter key to store any changed data.</p>
	Enter key	<p>Enters and stores changed data. (To change the set value, be sure to press the Enter key.) Do not press the Enter key if you don't want to store any changes, for example, if you have changed the data inadvertently.</p>
	Increment key	<p>Changes the mode. Also, increases the set value of each function.</p>
	Decrement key	<p>Changes the mode. Also, decreases the set value of each function.</p>

3-4 Operation Procedure (Example: Factory Default)

Displaying the Monitor Mode, Basic Function Mode, and Extended Function Mode

Power On



1. The data of the set monitor is displayed. (Default is "0.0")

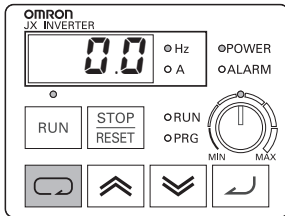

2. The code of the monitor mode is displayed (as "d001").

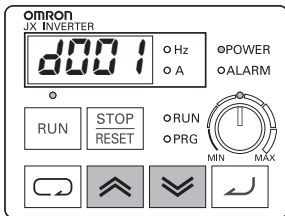

- Press the Mode key once to return from the code display of the monitor mode to the monitor display.



("d002" is displayed.)

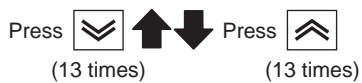
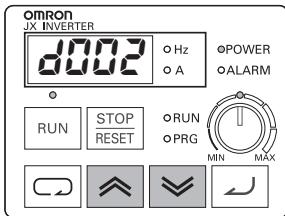

(Continued to the next page)

3. The code of the basic function mode is displayed (as "F001").

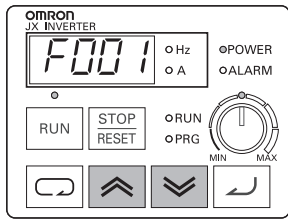

Press    Press 
(4 times) (4 times)

4. The extended function mode is displayed (as "A---").

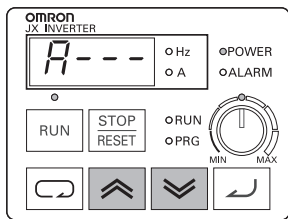

- Extended function mode
Displays in order of A ⇔ b ⇔ C ⇔ H.

Press    Press 
(4 times) (4 times)

5. The code of the monitor mode is displayed (as "d001").

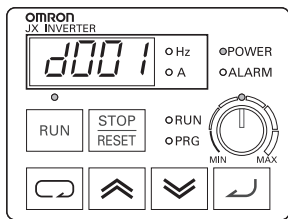

- Returns to step 2.

Setting Functions

- Switch the method of the RUN command. (Digital Operator → Control terminal block)
- To switch the method of the RUN command from the Digital Operator (factory default) to the control terminal block, you need to change the frequency reference selection (A001) from the Digital Operator (02) to the terminal (01).

1. Display the extended function mode (as "A---").

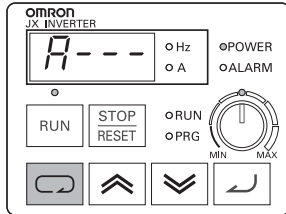

- To display "A---", follow the indication method described in "Displaying the Monitor Mode, Basic Function Mode, and Extended Function Mode" (page 3-10).
- By default, the RUN command LED indicator will light up as the RUN command selection is set to the Digital Operator.



2. The code of the extended function mode is displayed (as "A001").

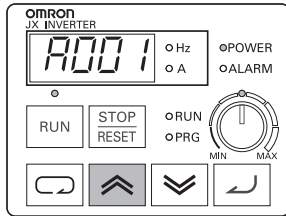

("A002" is displayed.)

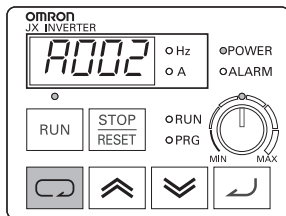

3. The setting of the extended function mode is displayed (setting in "A002").

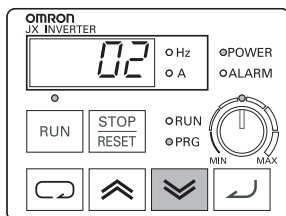

- "02 (Digital Operator)" (default setting) is displayed in the RUN command selection (A002).
- The PROGRAM (PRG) LED indicator lights up while the extended function mode setting is displayed.



(Continued to the next page)

(Change the A002 setting.)

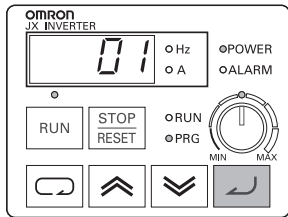

- Change the RUN command selection to the terminal "01".



4. The code of the monitor mode is displayed (as "A002").

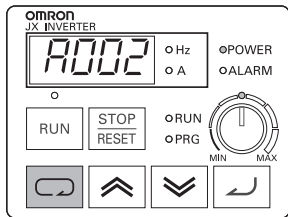

- Press the Enter key to fix the changed setting data.
- The RUN command selection is changed to the terminal, and the RUN command LED indicator will go off.
- You can now change to another extended function code.

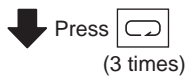

5. The extended function mode is displayed (as "A---").

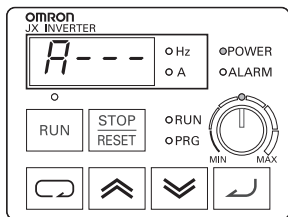

- You can now move to another extended function mode, the monitor mode, and the basic function mode.

Setting Function Codes

- You can enter codes for the monitor mode, basic function mode, and extended function mode directly, as well as through the scrolling method.
- Below is an example where code d001 of the monitor mode is changed to extended function A029.

1. Display the code of the monitor mode (as "d001").

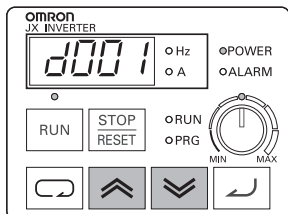

(Continued to the next page)

3-4 Operation Procedure (Example: Factory Default)

2. Change the function code.

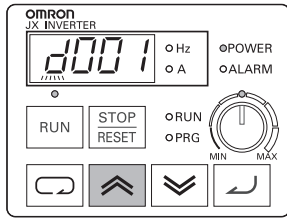

- You can change the 4th digit when "d" blinks.

↓ Press 
(2 times)

("A001" is displayed.)

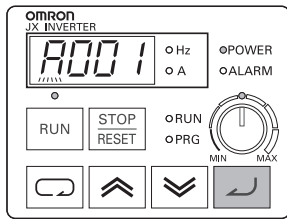

- "A" blinks.
- Press the Enter key to fix the blinking digit.

↓ Press 
("A" is entered.)

3. Change the 3rd digit of the function code.

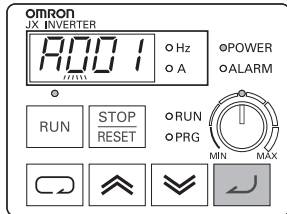

- "0" of the 3rd digit blinks.
- Press the Enter key to fix "0" of the 3rd digit as you need not change it.
- Press the Mode key to start "A" blinking again.

↓ Press 
("0" is entered.)

4. Change the 2nd digit of the function code.

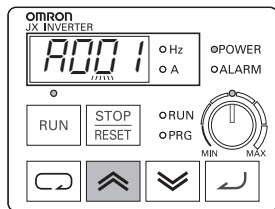

- "0" of the 2nd digit blinks.
- Press the Mode key to start "0" of the 3rd digit blinking again.

↓ Press 
(2 times)

(Continued to the next page)

("A021" is displayed.)

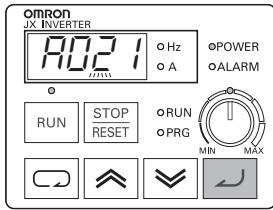

- "2" of the 2nd digit blinks.

↓ Press

5. Change the 1st digit of the function code.

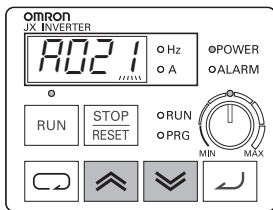

- "1" of the 1st digit blinks.
- Press the Mode key to start "2" of the 2nd digit blinking again.

↓ Press or (2 times) (8 times)

("A029" is displayed.)

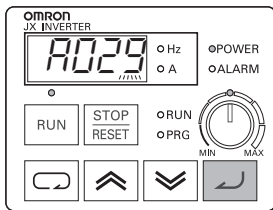

- "9" of the 1st digit blinks.

↓ Press ("9" is entered.)

6. The function code selection is complete.

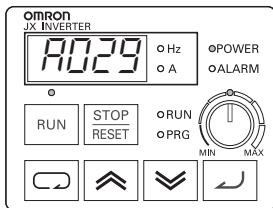

"A029" selection completed.

- Press the Mode key to change the data for A029.

(Supplemental Information)

- If you enter a parameter number that is not included in the parameter list, the display returns to the parameter previously displayed.
- Press the Enter key to shift the digit to the right, and the Mode key to shift to the left.

3-5 Parameter Transition

3

Operation

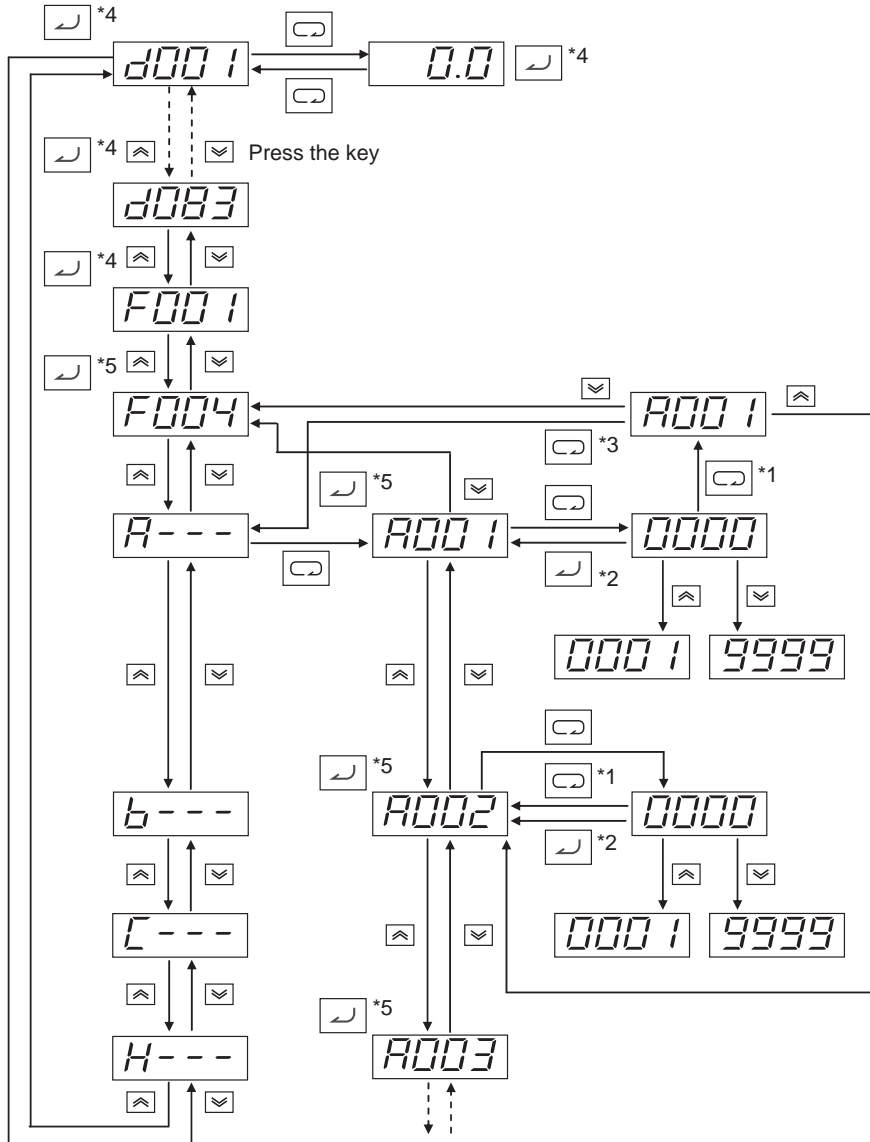

- *1. Data is not stored by pressing the Mode key.
- *2. Press the Enter key to store the data.
- *3. When you press the Mode key after you return to the parameter number display without storing data in the extended function mode, the mode selection function is selected.
- *4. When you press the Enter key with d*** or F001 displayed, the monitor value is stored as the initial display that appears when the power is turned on.
- *5. When you press the Enter key, the first digit of each parameter setting is stored as the initial display that appears when the power is turned on.

(Example: `F002`, `A---`, etc.)

* To display a specific monitor when the power is turned on, press the Enter key with that monitor displayed. If a parameter for an extended function code is stored after pressing the Enter key, however, that code (A---, b---, C---, d---, or H---) appears at the next power-on. To prevent this, always press the Enter key again with the desired monitor displayed after storing a parameter.

3-6 Parameter List

Monitor Mode (d□□□)

Parm No.	Name	Monitor or data range (Digital Operator)	Default setting	Change during Run	Unit	Modbus Address (Hex)	Page
d001	Output frequency monitor	0.0 to 400.0	—	—	Hz	1002	4-2
d002	Output current monitor	0.0 to 999.9	—	—	A	1003	4-2
d003	Rotation direction monitor	F: Forward o: Stop r: Reverse	—	—	—	1004	4-2
d004	PID feedback value monitor	0.00 to 99.99 100.0 to 999.9 1000. to 9999. (Enabled when the PID function is selected)	—	—	—	1005 M 1006 L	4-2
d005	Multi-function input monitor	 Example) Terminal 4, 2: ON Terminal 5, 3, 1: OFF	—	—	—	1007	4-3
d006	Multi-function output monitor	 Example) Terminal 11: ON Terminal AL2: OFF	—	—	—	1008	4-3
d007	Output frequency monitor (after conversion)	0.00 to 99.99 100.0 to 999.9 1000. to 9999. 1000 to 3996 (10000 to 39960) (Output frequency × Conversion factor of b086)	—	—	—	1009 M 100A L	4-3
d013	Output voltage monitor	0. to 600.	—	—	V	100C	4-4
d016	Total RUN Time	0. to 9999. 1000 to 9999 ┌ 100 to ┌ 999 (10000 to 99990 hours)	—	—	h	100E M 100F L	4-4
d017	Power ON time monitor	0. to 9999. 1000 to 9999 ┌ 100 to ┌ 999 (10000 to 99990 hours)	—	—	h	1010 M 1011 L	4-4
d018	Fin temperature monitor	0.0 to 200.0	—	—	°C	116A	4-4
d080	Fault frequency monitor	0. to 9999.	—	—	—	0011	4-4
d081	Fault monitor 1 (Latest)	Error code (condition of occurrence) → Output frequency [Hz] → Output current [A] → Internal DC voltage [V] → RUN time [h] → ON time [h]	—	—		0012 to 001B	4-5
d082	Fault monitor 2					001C to 0025	
d083	Fault monitor 3					0026 to 002F	
d102	DC voltage monitor	0.0 to 999.9	—	—	V	116C	4-5
d104	Electronic thermal monitor	0.0 to 100.0	—	—	%	116D	4-5

Basic Function Mode (F□□□)

Parm No.	Name	Monitor or data range (Digital Operator)	Default setting	Change during Run	Unit	Modbus Address (Hex)	Page
F001	Output frequency setting/monitor	Starting frequency to 1st or 2nd max. frequency	—	Yes	Hz	-	4-6
F002	Acceleration time 1	0.01 to 99.99 100.0 to 999.9 1000. to 3000.	10.0	Yes	s	1014 M 1015 L	4-6
F202	*2nd acceleration time 1	0.01 to 99.99 100.0 to 999.9 1000. to 3000.	10.0	Yes	s	1501 M 1502 L	4-6
F003	Deceleration time 1	0.01 to 99.99 100.0 to 999.9 1000. to 3000.	10.0	Yes	s	1016 M 1017 L	4-6
F203	*2nd deceleration time 1	0.01 to 99.99 100.0 to 999.9 1000. to 3000.	10.0	Yes	s	1503 M 1504 L	4-6
F004	Operator rotation direction selection	00: Forward 01: Reverse	00	No	—	1018	4-7

* 2nd control is displayed when SET(08) is allocated to one of the digital inputs.

Extended function mode

Parameter No.	Function name	Monitor or data range (Digital Operator)	Default setting	Change during Run	Unit	Modbus Address (Hex)	Page	
Basic setting	A001	Frequency reference selection	00: Digital Operator (FREQ adjuster) 01: Terminal	01	No	—	1019	4-8
	A201	*2nd frequency reference selection	02: Digital Operator (F001) 03: ModBus communication 10: Frequency operation result	01	No	—	-	4-8
	A002	RUN command selection	01: Terminal 02: Digital Operator	01	No	—	101A	4-8
	A202	*2nd RUN command selection	03: ModBus communication	01	No	—	-	4-8
	A003	Base frequency	30. to Max. frequency [A004]	50	No	Hz	101B	4-9
	A203	*2nd base frequency	30. to Max. frequency [A204]	50			150C	
	A004	Maximum frequency	30. to 400.	50	No	Hz	101C	4-10
A204	*2nd maximum frequency	50		150D				
Analog input	A005	O/OI selection	02: Switches between O/FREQ adjuster via terminal AT 03: Switches between FI/FREQ adjuster via terminal AT 04: O input only 05: OI input only	02	No	—	101D	4-10
	A011	O start frequency	0.0 to Max. frequency	0.0	No	Hz	1020	4-11
	A012	O end frequency	0.0 to Max. frequency	0.0	No	Hz	1022	4-11
	A013	O start ratio	0. to 100.	0.	No	%	1023	4-11
	A014	O end ratio	0. to 100.	100.	No	%	1024	4-11
	A015	O start selection	00: External start frequency (A011 set value) 01: 0 Hz	01	No	—	1025	4-11
	A016	O, OI sampling	1. to 17.	8.	No	—	1026	4-12

Parameter No.	Function name	Monitor or data range (Digital Operator)	Default setting	Change during Run	Unit	Modbus Address (Hex)	Page	
Multi-step speed, Jogging	A020	Multi-step speed reference 0	0.0/Starting frequency to Max. frequency	6.0	Yes	Hz	1029	4-12
	A220	*2nd multi-step speed reference 0	0.0/Starting frequency to 2nd max. frequency	6.0	Yes	Hz	150F	4-12
	A021	Multi-step speed reference 1	0.0/Starting frequency to Max. frequency	0.0	Yes	Hz	102B	4-12
	A022	Multi-step speed reference 2		0.0			102D	
	A023	Multi-step speed reference 3		0.0			102F	
	A024	Multi-step speed reference 4		0.0			1031	
	A025	Multi-step speed reference 5		0.0			1033	
	A026	Multi-step speed reference 6		0.0			1035	
	A027	Multi-step speed reference 7		0.0			1037	
	A028	Multi-step speed reference 8		0.0			1039	
	A029	Multi-step speed reference 9		0.0			103B	
	A030	Multi-step speed reference 10		0.0			103D	
	A031	Multi-step speed reference 11		0.0			103F	
	A032	Multi-step speed reference 12		0.0			1041	
	A033	Multi-step speed reference 13		0.0			1043	
	A034	Multi-step speed reference 14		0.0			1045	
	A035	Multi-step speed reference 15		0.0			1047	
	A038	Jogging frequency	0.00/Starting frequency to 9.99	6.00	Yes	Hz	1048	4-14
	A039	Jogging stop selection	00: Free-run stop 01: Deceleration stop 02: DC injection braking stop	00	No	—	1049	4-14
	Charact. Torque boost	A041	Torque boost selection	00: Manual torque boost only 01: Automatic (simple) torque boost	00	No	-	104A
A241		*2nd torque boost selection	00					1510
A042		Manual torque boost voltage	0.0 to 20.0	1.8	Yes	%	104B	4-15
A242		*2nd manual torque boost voltage		0.0			1511	

3-6 Parameter List

3

Operation

Parameter No.	Function name	Monitor or data range (Digital Operator)	Default setting	Change during Run	Unit	Modbus Address (Hex)	Page	
Charact. Torque boost	A043	Manual torque boost frequency	0.0 to 50.0	10	Yes	%	104C	4-15
	A243	*2nd manual torque boost frequency						
	A044	V/f characteristics selection	00: Constant torque characteristics (VC) 01: Reduced torque characteristics (VP 1.7th power) 06: Special reduced torque characteristics (Special VP)	00	No	-	104D	4-15
	A244	*2nd V/f characteristics selection						
	A045	Output voltage gain	20. to 100.	100.	Yes	%	104E	4-15
	A245	*2nd output voltage gain						100.
DC injection braking	A051	DC injection braking selection	00: Disabled 01: Enabled 02: Frequency control [A052 set value]	00	No	—	1051	4-17
	A052	DC injection braking frequency	0.0 to 60.0	0.5	No	Hz	1052	4-17
	A053	DC injection braking delay time	0.0 to 5.0	0.0	No	s	1053	4-17
	A054	DC injection braking power	0. to 100.	50	No	%	1054	4-17
	A055	DC injection braking time	0.0 to 60.0	0.5	No	s	1055	4-17
	A056	DC injection braking method selection	00: Edge operation 01: Level operation	01	No	—	1056	4-17
Upper/Lower limit, Jump	A061	Frequency upper limit	0.0/Frequency lower limit to Max. frequency	0.0	No	Hz	105A	4-20
	A261	*2nd frequency upper limit	0.0/Frequency lower limit to 2nd Max. frequency					
	A062	Frequency lower limit	0.0/Starting frequency to Frequency upper limit	0.0	No	Hz	105B	4-20
	A262	*2nd frequency lower limit	0.0/Starting frequency to 2nd frequency upper limit					
	A063	Jump frequency 1	Jump frequency: 0.0 to 400.0 Jump frequency width: 0.0 to 10.0	0.0	No	Hz	105D	4-21
	A064	Jump frequency width 1		0.5				
	A065	Jump frequency 2		0.0				
	A066	Jump frequency width 2		0.5				
A067	Jump frequency 3	0.0						
A068	Jump frequency width 3	0.5						
PID control	A071	PID selection	00: Disabled 01: Enabled	00	No	—	1068	4-22
	A072	PID P gain	0.2 to 5.0	1.0	Yes	—	1069	4-22
	A073	PID I gain	0.0 to 150.0	1.0	Yes	s	106A	4-22
	A074	PID D gain	0.00 to 100.0	0.0	Yes	s	106B	4-22
	A075	PID scale	0.01 to 99.99	1.00	No	Time	106C	4-22
	A076	PID feedback selection	00: OI 01: O 02: RS485 communication 10: Operation function output	00	No	—	106D	4-22

Parameter No.	Function name	Monitor or data range (Digital Operator)	Default setting	Change during Run	Unit	Modbus Address (Hex)	Page	
PID control	A077	Reverse PID function	00: OFF (Deviation = Target value - Feedback value) 01: ON (Deviation = Feedback value - Target value)	00	No	—	106E 4-22	
	A078	PID output limit function	0.0 to 100.0	0.0	No	%	106F 4-22	
AVR	A081	AVR selection	00: Always ON 01: Always OFF 02: OFF during deceleration	02	No	—	1070 4-26	
	A082	AVR voltage selection	200-V class: 200/215/220/230/240 400-V class: 380/400/415/440/460/480	200/400	No	V	1071 4-26	
RUN mode, Acceleration/Deceleration functions	A085	RUN mode selection	00: Normal operation 01: Energy-saving operation	00	No	-	1072 4-26	
	A086	Energy-saving response/accuracy adjustment	0 to 100	50	No	%	1073 4-26	
	A092	Acceleration time 2	0.01 to 99.99 100.0 to 999.9 1000. to 3000.	10.00	Yes	s	1074 M 1075 L	4-27
	A292	*2nd acceleration time 2		10.00			1519 M 151A L	
	A093	Deceleration time 2	0.01 to 99.99 100.0 to 999.9 1000. to 3000.	10.00	Yes	s	1076 M 1077 L	4-27
	A293	*2nd deceleration time 2		10.00			151B M 151C L	
	A094	2-step accel/decel selection	00: Switched via multi-function input 09 (2CH) 01: Switched by setting	00	No	—	1078	4-27
	A294	*2nd 2-step accel/decel selection		00			151D	
	A095	2-step acceleration frequency	0.0 to 400.0	0.0	No	Hz	107A	4-27
	A295	*2nd 2-step acceleration frequency		0.0			151F	
	A096	2-step deceleration frequency	0.0 to 400.0	0.0	No	Hz	107C	4-27
	A296	*2nd 2-step deceleration frequency		0.0			1521	
	A097	Acceleration pattern selection	00: Line 01: S-shape curve	00	No	—	107D 4-28	
	A098	Deceleration pattern selection	00: Line 01: S-shape curve	00	No	—	107E 4-28	
	External frequency adjust	A101	OI start frequency	0.0 to 400.0	0.0	No	Hz	4-11 4-28
		A102	OI end frequency	0.0 to 400.0	0.0	No	Hz	4-11 4-28
A103		OI start ratio	0. to 100.	0.	No	%	4-11 4-28	
A104		OI end ratio	0. to 100.	100.	No	%	4-11 4-28	
A105		OI start selection	00: Use OI start frequency [A101] 01: 0 Hz start	01	No	—	4-11 4-28	

3-6 Parameter List

Parameter No.	Function name	Monitor or data range (Digital Operator)	Default setting	Change during Run	Unit	Modbus Address (Hex)	Page	
Operation frequency	A141	Operation frequency input A setting	00: Digital Operator (F001) 01: Digital Operator (FREQ adjuster) 02: Input O 03: Input OI 04: RS485 communication	01	No	—	108E	4-29
	A142	Operation frequency input B setting		02	No	—	108F	4-29
	A143	Operator selection	00: Addition (A + B) 01: Subtraction (A - B) 02: Multiplication (A × B)	00	No	—	1090	4-29
Frequency addition	A145	Frequency addition amount	0.0 to 400.0	0.0	Yes	Hz	1091	4-29
	A146	Frequency addition direction	00: Adds A145 value to output frequency 01: Subtract A145 value from output frequency	00	No	—	1093	4-29
VR adjustment	A151	VR start frequency	0.0 to 400.0	0.0	No	Hz	1095	4-11
	A152	VR end frequency	0.0 to 400.0	0.0	No	Hz	1097	4-11
	A153	VR start ratio	0. to 100.	0.	No	%	1098	4-11
	A154	VR end ratio	0. to 100.	100.	No	%	1099	4-11
	A155	VR start selection	00: Use VR start frequency [A151] 01: 0 Hz start	01	No	—	109A	4-11
Restart during momentary power interruption	b001	Retry selection	00: Alarm 01: 0 Hz start 02: Frequency matching start 03: Trip after frequency matching deceleration stop	00	No	—	10A5	4-30
	b002	Allowable momentary power interruption time	0.3 to 25.0	1.0	No	s	10A6	4-30
	b003	Retry wait time	0.3 to 100.0	1.0	No	s	10A7	4-30 4-41
	b004	Momentary power interruption/ undervoltage trip during stop selection	00: Disabled 01: Enabled	00	No	—	10A8	4-30
	b005	Momentary power interruption retry time selection	00: 16 times 01: No limit	00	No	—	10A9	4-30
	b011	Starting frequency at Active Frequency Matching restart	00: Frequency at interruption 01: Max. frequency 02: Set frequency	00	No	—	1170	4-30
Electronic thermal	b012	Electronic thermal level	0.2 × Rated current to 1.0 × Rated current	Rated current	No	A	10AD	4-32
	b212	*2nd electronic thermal level		Rated current			1527	

Parameter No.	Function name	Monitor or data range (Digital Operator)	Default setting	Change during Run	Unit	Modbus Address (Hex)	Page
Electronic thermal	b013	Electronic thermal characteristics selection	00: Reduced torque characteristics 1 01: Constant torque characteristics 02: Reduced torque characteristics 2	01	No	—	10AE
	b213	*2nd electronic thermal characteristics selection					
Overload limit	b021	Overload limit selection	00: Disabled 01: Enabled in acceleration/constant speed operation 02: Enabled in constant speed operation	00	No	—	10B5
	b221	*2nd overload limit selection					
	b022	Overload limit level	0.1 × Rated current to 1.5 × Rated current	1.5 × Rated current	No	A	10B6
	b222	*2nd overload limit level					
	b023	Overload limit parameter	0.1 to 3000.0	1.0	No	s	10B7
	b223	*2nd overload limit parameter					
	b028	Overload limit source selection	00: b022, b222 set values 01: Input terminal O	00	No	—	10BB
	b228	*2nd overload limit source selection					
Active Freq Match	b029	Deceleration rate constant at Active Frequency Matching restart	0.1 to 3000.0	0.5	No	s	1171
	b030	Active Frequency Matching restart level	0.2 × Rated current to 2.0 × Rated current	Rated current	No	A	1172
Lock	b031	Soft lock selection	00: Data other than b031 cannot be changed when terminal SFT is ON. 01: Data other than b031 and the specified frequency parameter cannot be changed when terminal SFT is ON. 02: Data other than b031 cannot be changed. 03: Data other than b031 and the specified frequency parameter cannot be changed. 10: Data other than parameters changeable during operation cannot be changed.	01	No	—	10BC
Non-stop at momentary power interruption	b050	Selection of non-stop function at momentary power interruption	00: Disabled 01: Enabled (Stop) 02: Enabled (Restart)	00	No		10C9
	b051	Starting voltage of non-stop function at momentary power interruption	0.0 to 1000.	0.0	No	V	10CA
	b052	Stop deceleration level of non-stop function at momentary power interruption	0.0 to 1000.	0.0	No	V	10CB

3-6 Parameter List

Parameter No.	Function name	Monitor or data range (Digital Operator)	Default setting	Change during Run	Unit	Modbus Address (Hex)	Page	
Non-stop at momentary power interruption	b053	Deceleration time of non-stop function at momentary power interruption	0.01 to 99.99 100.0 to 999.9 1000 to 3000	1.0	No	s	10CC	4-36
	b054	Deceleration starting width of non-stop function at momentary power interruption	0.0 to 10.0	0.0	No	Hz	10CE	4-36
Others	b055	Overvoltage protection proportional gain during deceleration	0.2 to 5.0	0.2	Yes	—	1173	4-37
	b056	Overvoltage protection integral time during deceleration	0.0 to 150.0	0.2	Yes	s	1174	4-37
	b080	AM adjustment	0. to 255. (Shared with C086 for AM offset adjustment)	100.	Yes	—	10CF	4-39 4-62
	b082	Starting frequency	0.5 to 9.9	0.5	No	Hz	10D1	4-39
	b083	Carrier frequency	2.0 to 12.0	3.0	No	kHz	10D2	4-40 4-63
Initialization	b084	Initialization selection	00: Clears the trip monitor 01: Initializes data 02: Clears the trip monitor and initializes data	00	No	—	10D3	4-41
	b085	Initialization parameter selection	01 * Do not change.	01	No	—	10D4	4-41
Others	b086	Frequency conversion coefficient	0.1 to 99.9	1.0	Yes	—	10D5	4-41
	b087	STOP key selection	00: Enabled 01: Disabled	00	No	—	10D6	4-41
	b088	Free-run stop selection	00: 0 Hz start 01: Active Frequency Matching restart	00	No	—	10D7	4-41
	b089	Monitor display selection	01: Output frequency monitor 02: Output current monitor 03: Rotation direction monitor 04: PID feedback value monitor 05: Multi-function input monitor 06: Multi-function output monitor 07: Frequency conversion monitor	01	Yes	—	10D8	4-42
	b091	Stop selection	00: Deceleration → Stop 01: Free-run stop	00	No	—	10DA	4-41
	b092	Cooling fan control	00: Always ON 01: ON during RUN 02: Depends on the fin temperature	01	No	—	10DB	4-43
	b130	Overvoltage LAD stop function	00: Disabled 01: Enabled	00	No	—	10F5	4-38

Parameter No.	Function name	Monitor or data range (Digital Operator)	Default setting	Change during Run	Unit	Modbus Address (Hex)	Page	
Others	b131	Overvoltage LAD stop function level setting	200-V class: 330. to 395. 400-V class: 660. to 790.	380/760	Yes	V	10F6	4-38
	b133	Overvoltage protection function selection during deceleration	00: Disabled 01: Enabled	00	No	—	1176	4-37
	b134	Overvoltage protection level setting during deceleration	200-V class: 330. to 395. 400-V class: 660. to 790.	380/760	No	V	1177	4-37
	b140	Overcurrent suppression function	00: Disabled 01: Enabled	01	No	—	10F7	4-43
	b150	Automatic carrier reduction	00: Disabled 01: Enabled	00	No	—	10F8	4-43
	b151	Ready function selection	00: Disabled 01: Enabled	00	No	—	10F9	4-43
Multi-function input terminals	C001	Multi-function input 1 selection	00: FW (forward) 01: RV (reverse)	00	No	—	1103	4-44
	C201	*2nd multi-function input 1 selection	02: CF1 (multi-step speed setting binary 1) 03: CF2 (multi-step speed setting binary 2) 04: CF3 (multi-step speed setting binary 3) 05: CF4 (multi-step speed setting binary 4) 06: JG (jogging)	00			1532	
	C002	Multi-function input 2 selection	07: DB (external DC injection braking) 08: SET (2nd control) 09: 2CH (2-step acceleration/deceleration)	01			1104	
	C202	*2nd multi-function input 2 selection	11: FRS (free-run stop) 12: EXT (external trip) 13: USP (USP function) 15: SFT (soft lock)	01			1533	
	C003	Multi-function input 3 selection	16: AT (analog input switching) 18: RS (reset) 19: PTC (thermistor input)	18			1105	
	C203	*2nd multi-function input 3 selection	20: STA (3-wire start) 21: STP (3-wire stop) 22: F/R (3-wire forward/reverse) 23: PID (PID enabled/disabled) 24: PIDC (PID integral reset)	18			1534	
	C004	Multi-function input 4 selection	27: UP (UP/DWN function accelerated) 28: DWN (UP/DWN function decelerated) 29: UDC (UP/DWN function data clear)	12			1106	
	C204	*2nd multi-function input 4 selection	31: OPE (forced operator) 50: ADD (frequency addition) 51: F-TM (forced terminal block) 52: RDY (ready function)	12			1535	
	C005	Multi-function input 5 selection	53: SP-SET (special 2nd function) 64: EMR (emergency shutoff *1) 255: No function	02			1107	
	C205	*2nd multi-function input 5 selection	*1. The EMR is set forcibly with switch S8, not with parameters.	02			1536	

3-6 Parameter List

3

Operation

Parameter No.	Function name	Monitor or data range (Digital Operator)	Default setting	Change during Run	Unit	Modbus Address (Hex)	Page	
Multi-function input terminals	C011	Multi-function input 1 operation selection	00	No	—	110B	4-44	
	C012	Multi-function input 2 operation selection	00			110C		
	C013	Multi-function input 3 operation selection	00: NO 01: NC			00		110D
	C014	Multi-function input 4 operation selection	00			110E		
	C015	Multi-function input 5 operation selection	00			110F		
Multi-function output setting	C021	Multi-function output terminal 11 selection	00	No	—	1114	4-55	
	C026	Relay output (AL2, AL1) function selection	05			1119		
	C028	AM selection	00: Output frequency 01: Output current	00	No	—	111B	4-62
	C031	Multi-function output terminal 11 contact selection	00: NO contact at AL2; NC contact at AL1 01: NC contact at AL2; NO contact at AL1	00	No	—	111D	4-61
	C036	Relay output (AL2, AL1) contact selection		01			1122	
	C038	Light load signal output mode	00: Enabled during acceleration/deceleration/ constant speed 01: Enabled only during constant speed	01	No	—	1178	4-60
	C039	Light load detection level	0.0 to 2.0 × Rated current (0.0 setting: Function disable)	Rated current	No	—	1179	4-60
Level output status setting	C041	Overload warning level	0.0: Does not operate 0.1 × Rated current to 2.0 × Rated current	Rated current	No	A	1124	4-33
	C241	*2nd overload warning level		Rated current			153A	
	C042	Arrival frequency during acceleration	0.0 to 400.0	0.0	No	Hz	1126	4-56
	C043	Arrival frequency during deceleration	0.0 to 400.0	0.0	No	Hz	1128	4-56
	C044	PID deviation excessive level	0.0 to 100.0	3.0	No	%	1129	4-22
	C052	PID FB upper limit	0.0 to 100.0	100	No	%	112E	4-22
	C053	PID FB lower limit		0.0			112F	

Parameter No.	Function name	Monitor or data range (Digital Operator)	Default setting	Change during Run	Unit	Modbus Address (Hex)	Page
Communication function adjustment	C070	Operator/ModBus selection	02: Digital Operator 03: ModBus	02	No	—	1137
	C071	Communication speed selection (Baud rate selection)	04: 4800 bps 05: 9600 bps 06: 19200 bps	06	No	—	1138
	C072	Communication station No. selection	1. to 32.	1.	No	—	1139
	C074	Communication parity selection	00: No parity 01: Even 02: Odd	00	No	—	113B
	C075	Communication stop bit selection	1: 1-bit 2: 2-bit	1	No	—	113C
	C076	Communication error selection	00: Trip 01: Trip after deceleration stop 02: Ignore 03: Free run 04: Deceleration stop	02	No	—	113D
	C077	Communication error timeout	0.00 to 99.99	0.00	No	s	113E
	C078	Communication wait time	0. to 1000.	0.	No	ms	113F
Various adjustment	C081	O adjustment	0.0 to 200.0	100.0	Yes	%	1141
	C082	OI adjustment	0.0 to 200.0	100.0	Yes	%	1142
Others	C086	AM offset adjustment	0.0 to 10.0	0.0	Yes	V	1145
	C091	Not used	Use "00". *Do not change.	00	—	—	—
	C101	UP/DWN selection	00: Do not store the frequency data 01: Store the frequency data	00	No	—	1149
	C102	Reset selection	00: Trip reset at rising edge of RS input 01: Trip reset at falling edge of RS input 02: Enabled only during trip (Reset at rising edge of RS input)	00	No	—	114A
	C141	Logic operation function A input	00: RUN (signal during RUN) 01: FA1 (constant speed arrival signal) 02: FA2 (over set frequency arrival signal) 03: OL (overload warning) 04: OD (excessive PID deviation) 05: AL (alarm output)	00	No	—	1150
	C142	Logic operation function B input	06: Dc (disconnection detected) 07: FBV (PID FB status output) 08: NDc (network error) 10: ODC (Do not use.) 43: LOC (light load detection signal)	01	No	—	1151
	C143	Logic operator selection	00: AND 01: OR 02: XOR	00	No	—	1152
	C144	Output terminal 11 ON delay	0.0 to 100.0	0.0	No	s	1153

3-6 Parameter List

Parameter No.	Function name	Monitor or data range (Digital Operator)	Default setting	Change during Run	Unit	Modbus Address (Hex)	Page	
Others	C145	Output terminal 11 OFF delay	0.0 to 100.0	0.0	No	s	1154	4-60
	C148	Relay output ON delay	0.0 to 100.0	0.0	No	s	1157	4-60
	C149	Relay output OFF delay	0.0 to 100.0	0.0	No	s	1158	4-60
Control parameter	H003	Motor capacity selection	200-V class 0.2/0.4/0.75/1.5/2.2/3.7/5.5/7.5 400-V class 0.4/0.75/1.5/2.2/3.7/5.5/7.5	Factory default	No	kW	1165	4-63
	H203	*2nd motor capacity selection		Factory default			1541	
	H004	Motor pole number selection	2 4	4	No	Pole	1166	4-63
	H204	*2nd motor pole number selection	6 8	4			1542	
	H006	Stabilization parameter	0. to 255.	100	Yes	%	1168	4-63
	H206	*2nd stabilization parameter		100	Yes	%	1544	

Chapter 4

Functions

4-1	Monitor Mode.....	4-2
4-2	Function Mode.....	4-6

4-1 Monitor Mode

Output Frequency Monitor [d001]

Displays the output frequency of the Inverter.
The monitor LED indicator "Hz" lights up while d001 is displayed.

(Display)
0.0 to 400.0: Displays in increments of 0.1 Hz.

Output Current Monitor [d002]

Displays the output current value of the Inverter.
The monitor LED indicator "A" lights up while d002 is displayed.

(Display)
0.0 to 999.9: Displays in increments of 0.1 A.

Rotation Direction Monitor [d003]

Displays whether the Inverter output is in forward/reverse/stop status. The RUN LED indicator lights up during forward/reverse rotation.

(Display)
F: Forward
o: Stop
r: Reverse

PID Feedback Value Monitor [d004]

Displays a feedback value converted by [A075] (PID scale) when the PID selection is enabled ([A071] = 01).

"Monitor display" = "PID feedback value (%)" × "PID scale"
[A075]

(Setting)
A071: 01 (PID enabled)
A075: 0.01 to 99.99 (Can be set in increments of 0.01.)

(Display)
0.00 to 99.99 : Displays in increments of 0.01.
100.0 to 999.9 : Displays in increments of 0.1.
1000 to 9999 : Displays in increments of 1.

Multi-function Input Monitor [d005]

Displays the input status of the multi-function input terminals.

C011 to C015 (contact selection) are excluded so only physical status will be displayed disregarding of the normally open or normally close selectiong.

(Example) Multi-function input terminals 4, 2 : ON
Multi-function input terminals 5, 3, 1 : OFF

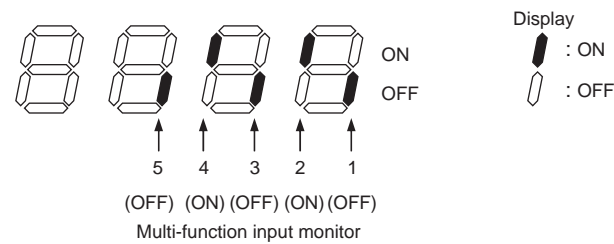

Multi-function Output Monitor [d006]

Displays the output status of the multi-function output terminals and relay output terminals.

C031 and C036 (contact selection) are excluded so this monitor indicates the signal status of the functions (C021 and C026) allocated to each multi-function output terminal disregarding the normaly open or close selection.

(Example) Multi-function output terminal 11 : ON
Relay output terminal AL2 : OFF

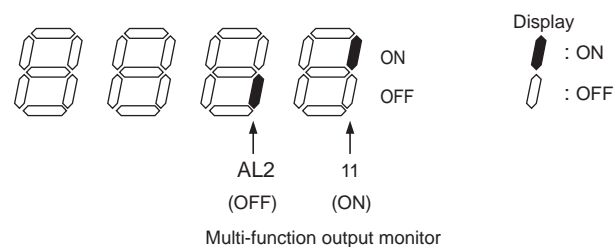

Output Frequency Monitor (After Conversion) [d007]

Displays a conversion value obtained by multiplying the Inverter output frequency by the coefficient set in [b086].

Displayed value = "Output frequency [d001]" × "Frequency conversion coefficient [b086]"

(Display) [d007]

0.00 to 99.99 : Displays in increments of 0.01.

100.0 to 999.9 : Displays in increments of 0.1.

1000. to 9999. : Displays in increments of 1.

1000 to 3996 : Displays in increments of 10.

(Setting range) [b086] 0.1 to 99.9: Can be set in increments of 0.1.

(Example)

When the output frequency [d001] = 50.0 Hz, and the frequency conversion coefficient [b086] = 1.1, the monitor [d007] displays "55.0" through $50.0 \times 1.1 = 55.0$.

Output Voltage Monitor [d013]

Displays the output voltage value (Vac) of the Inverter.
The monitor LED indicator "V" lights up.

(Display)
0. to 600.: Displays in increments of 1 V.

Total RUN Time [d016]

Displays the Inverter RUN time.

(Display)
0. to 9999. : Displays in increments of 1 hour.
1000 to 9999 : Displays in increments of 10 hours.
┌100 to ┌999 : Displays in increments of 1000 hours.

Power ON Time Monitor [d017]

Displays the total power supply time of the Inverter.

(Display)
0. to 9999. : Displays in increments of 1 hour.
1000 to 9999 : Displays in increments of 10 hours.
┌100 to ┌999 : Displays in increments of 1000 hours.

Fin Temperature Monitor [d018]

Displays the fin temperature.

(Display)
0. to 200. : Displays in increments of 1 °C.

Fault Frequency Monitor [d080]

Displays the number of times the Inverter has tripped.

(Display)
0. to 9999. : Displays in increments of 1 time.
1000 to 6553 : Displays in increments of 10 times.

Fault Monitors 1[d081], 2[d082], 3[d083]

Displays the details of the last three trips.
The most recent trip is displayed on trip monitor 1.

(Display)

- Factor (E01 to E60)*¹
- Output frequency at the time of tripping (Hz)
- Output current at the time of tripping (A)
- Internal DC voltage at the time of tripping (V)
- Total RUN time before the trip (hr)
- Total power supply time before the trip (hr)

*1. Refer to "Error Code List" (page 5-2) and "Trip Monitor Display" (page 5-5).

(Trip Monitor Display Sequence)

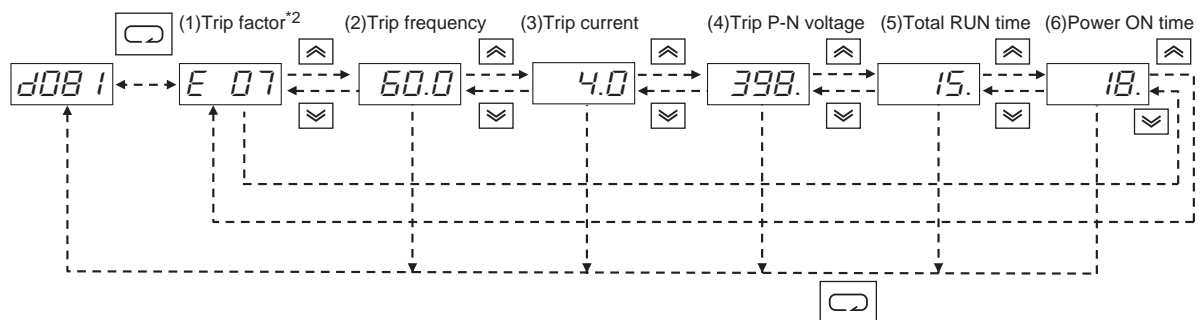

*2. Displays if there has been no trip.

DC Voltage Monitor [d102]

Displays the main circuit DC voltage of the Inverter.

(Display)

0.0 to 999.9 : Displays in increments of 0.1 V.

Electronic Thermal Monitor [d104]

Displays the count integration value of the electronic thermal. An overload trip occurs if it reaches 100% (E05).

(Display)

0.0 to 100.0 : Displays in increments of 0.1%.

4-2 Function Mode

<Group F: Basic Function Parameter>

Output Frequency Setting/Monitor

- Set the Inverter output frequency.
- With the frequency reference set to the Digital Operator ([A001] = 02), you can set the output frequency in F001. For other methods, refer to the [A001] section in "Frequency Reference Selection" (page 4-8).
- If a frequency is set in [F001], the same value is automatically set in multi-step speed reference 0 [A020]. To set the 2nd speed reference, use [A220], or use [F001] with the SET terminal turned on. To set by using the SET terminal, allocate 08 (SET) to the desired multi-function input.

Parameter No.	Function name	Data	Default setting	Unit
F001	Output frequency setting/monitor	0.0/Starting frequency to Max. frequency	6.0	Hz
A020	Multi-step speed reference 0			
* A220	2nd multi-step speed reference 0			
Related parameters		A001, A201, C001 to C005		

* To switch to the 2nd multi-step speed, allocate 08 (SET) to the multi-function input terminal and then turn it on.

Acceleration/Deceleration Time

Set an acceleration/deceleration time for the motor. For a slow transition, set a large value, and for a fast transition, set a small one.

Parameter No.	Function name	Data	Default setting	Unit
F002	Acceleration time 1	0.01 to 3000	10.0	s
* F202	2nd acceleration time 1			
F003	Deceleration time 1			
* F203	2nd deceleration time 1			
Related parameters		A004, A204, C001 to C005		

* To switch to 2nd acceleration/deceleration time 1, allocate 08 (SET) to the multi-function input terminal and then turn it on.

- The set time here indicates the acceleration/deceleration time between 0 Hz and the maximum frequency.

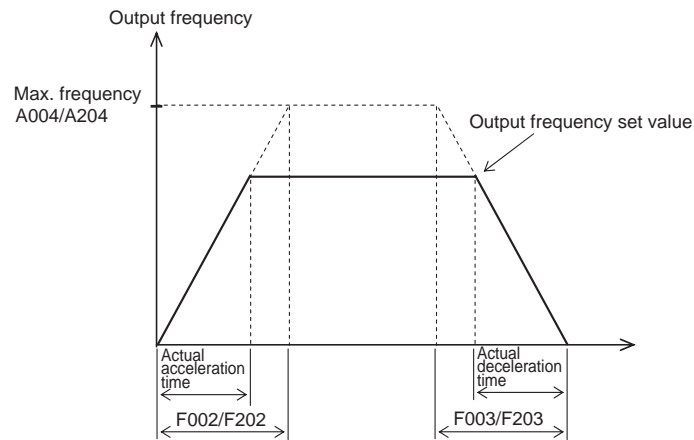

Even if a short acceleration/deceleration time is set, the actual time cannot be shorter than the minimum acceleration/deceleration time that is determined by the mechanical inertia moment and the motor torque. If you set a time shorter than the minimum time, an overcurrent/overvoltage trip may occur.

Acceleration Time T_S

$$T_S = \frac{(J_L + J_M) \times N_M}{9.55 \times (T_S - T_L)}$$

J_L :Inertia moment of the load converted to the motor shaft [kg·m²]

J_M :Inertia moment of the motor [kg·m²]

N_M :Motor rotation speed [r/min]

T_S :Max. acceleration torque with the Inverter driving [N·m]

T_B :Max. deceleration torque with the Inverter driving [N·m]

T_L :Required driving torque [N·m]

Deceleration Time T_B

$$T_B = \frac{(J_L + J_M) \times N_M}{9.55 \times (T_B + T_L)}$$

Digital Operator Rotation Direction Selection

Select the direction of motor rotation applied to the RUN command via the Digital Operator. This is disabled at terminals.

Parameter No.	Function name	Data	Default setting	Unit
F004	Operator rotation direction selection	00: Forward 01: Reverse	00	—

<Group A: Standard Function Parameter>

Frequency Reference Selection

Select the method of the frequency reference.

Parameter No.	Function name	Data	Default setting	Unit
A001	Frequency reference selection	00: Digital Operator (FREQ adjuster) 01: Terminal 02: Digital Operator (F001) 03: ModBus communication 10: Frequency operation result	01	—
* A201	2nd frequency reference selection			
Related parameters		A005, A141 to A143, A145, A146		

* To switch to the 2nd frequency reference, allocate 08 (SET) to the multi-function input terminal and then turn it on.

Data	Frequency reference source
00	FREQ adjuster
01	Voltage or current setpoint reference from the terminal.
02	F001 value set via the Digital Operator.
03	ModBus communication
10	Result of the frequency operation function

RUN Command Selection

Select the method of the RUN/STOP command.

Parameter No.	Function name	Data	Default setting	Unit
A002	RUN command selection	01: Terminal 02: Digital Operator 03: ModBus communication	01	—
* A202	2nd RUN command selection			
Related parameters		F004, A005, C001 to C005		

* To switch to the 2nd RUN command, allocate 08 (SET) to the multi-function input terminal and then turn it on.

Data	RUN command source
01	Turn ON/OFF by FW and RV allocated to the terminal. The STOP command is activated if both Forward/Reverse commands are input simultaneously.
02	Use the RUN and STOP/RESET keys on the Digital Operator.
03	Use the ModBus communication.

Base Frequency

■ Base Frequency and Motor Voltage

Match the Inverter output (frequency/voltage) to the motor rating. Be careful, especially if you set a base frequency at below 50 Hz. Otherwise, the motor may burn out.

Parameter No.	Function name	Data	Default setting	Unit
A003	Base frequency	30 to max. frequency [A004]	50.0	Hz
* A203	2nd base frequency	30 to max. frequency [A204]		
Related parameters		A004, A204, A081, A082		

* To switch to the 2nd base frequency, allocate 08 (SET) to the multi-function input terminal and then turn it on.

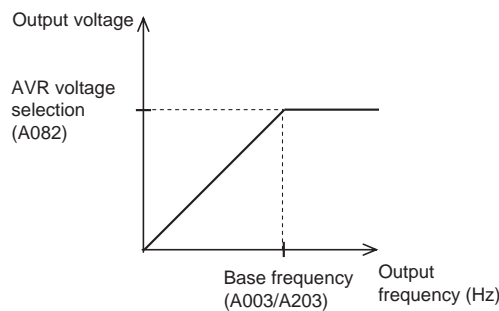

- Select the motor voltage according to the motor specifications. If the voltage exceeds the specified level, the motor may burn out.
- The Inverter cannot output voltage beyond that of the incoming voltage.

Maximum Frequency

Set the maximum value of the output frequency.

- The value set here will be the maximum value (e.g., 10 V in the range from 0 to 10 V) of the external analog input (frequency reference).
- The maximum Inverter output voltage from base to maximum frequencies is the voltage set at AVR voltage selection A082.
- The Inverter cannot output voltage beyond that of the incoming voltage.

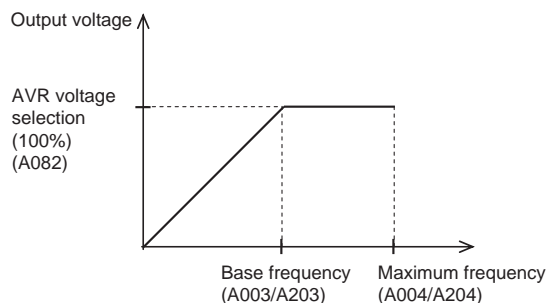

4-2 Function Mode

Parameter No.	Function name	Data	Default setting	Unit
A004	Maximum frequency	30 to 400	50.0	Hz
* A204	2nd maximum frequency			
Related parameters		A003, A203, A081, A082		

* To switch to the 2nd max. frequency, allocate 08 (SET) to the multi-function input terminal and then turn it on.

Analog Input (O, OI, VR)

Two types of external analog inputs are available for frequency reference plus the built-in VR. For voltage input, you can set a frequency from 0 to maximum by applying a voltage from 0 to 10 V between inputs O and L. For current input, apply 4 to 20 mA between inputs OI and L. Note that voltage and current cannot be input simultaneously. Also, do not connect the signal lines for inputs O and OI simultaneously.

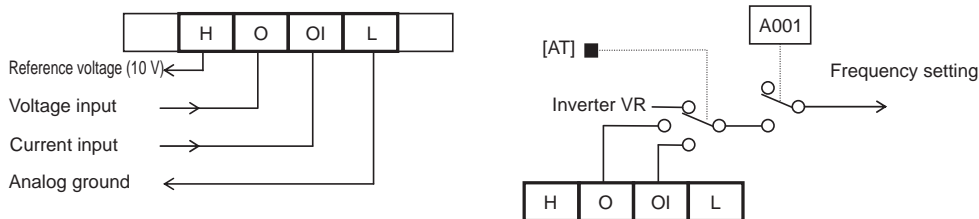

Switching between the inputs could be done by a digital input setting parameter A005.

Parameter No.	Function name	Data	Default setting	Unit
A005	O/OI selection	00: Switches between O/OI via terminal AT 02: Switches between O/FREQ adjuster via terminal AT 03: Switches between OI/FREQ adjuster via terminal AT 04: O input only 05: OI input only	02	—
Related parameters		A011 to A016, A101 to A105, A151 to A155, C001 to C005, C081, C082		
Required settings		A001 = 01		

Allocate AT (16) to any of the multi-function inputs with the frequency reference set to the terminal block (A001 or A201 = 01).

Data	Symbol	Function name	Status	Description
16	AT	Analog input switching	ON	Depends on the combination with the A005 setting (see the table below).
			OFF	Same as above.
Related parameters		C001 to C005		

The settings are as follows. (VR: FREQ adjuster)

If AT is not allocated to any of the multi-function input, this means the AT input = OFF in the above table..

A005 set value	00		02		03		04		05	
AT terminal input status	OFF	ON	OFF	ON	OFF	ON	OFF	ON	OFF	ON
Analog input enabled	O-L	OI-L	O-L	VR	OI-L	VR	O-L		OI-L	

External Frequency (Voltage/Current) Adjustment

External Analog Input (Frequency Reference)

O-L terminal: 0 to 10 V (voltage input)

OI-L terminal: 4 to 20 mA (current input)

Also set an output frequency for the FREQ adjuster on the Digital Operator.

Parameter No.	Function name	Data	Default setting	Unit
A011 A101 A151	O/OI/VR start frequency	0.00 to 400.0 (Set start/end frequency.)	0.0	Hz
A012 A102 A152	O/OI/VR end frequency			
A013 A103 A153	O/OI/VR start ratio	0. to 100. (Set a start/end ratio relative to an external frequency reference of between 0 to 10 V and 4 to 20 mA.)	0.	%
A014 A104 A154	O/OI/VR end ratio		100.	
A015 A105 A155	O/OI/VR start selection	00: Start frequency (A011 set value) 01: 0 Hz	01	—
Related parameters		A005, A016, AT input		

•To input voltage ranging from 0 to 5 V on the O-L terminal, set A014 to 50%.

(Example 1) A015/A105 = 00

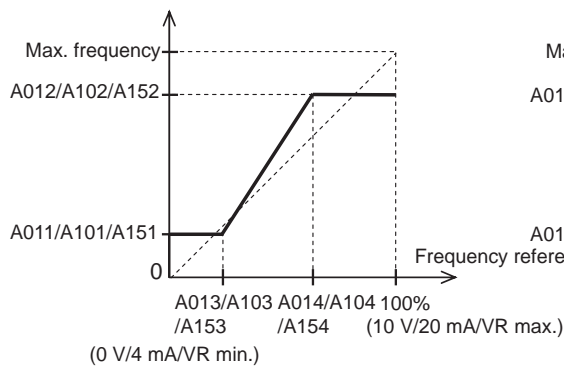

(Example 2) A015/A105 = 01

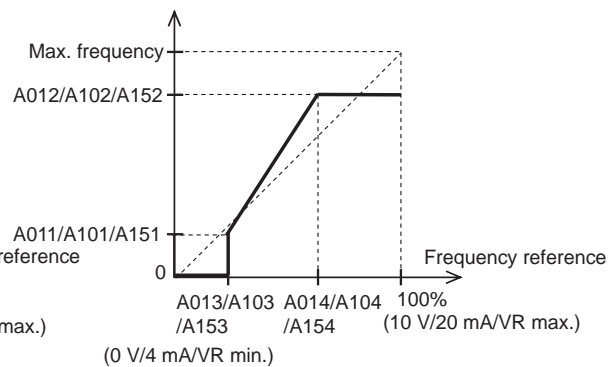

O/OI Adjustment

Parameter No.	Function name	Data	Default setting	Unit
C081	O adjustment	0.0 to 200.0	100	%
C082	OI adjustment	0.0 to 200.0	100	%

- You can adjust the O/OI frequency input.
- Use this to change the full scale of input.
- The set frequency becomes 0 Hz with 0.0% set.

- This returns to the factory default value after initialization.

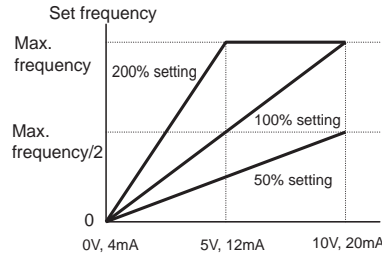

O, OI Sampling

Set the built-in filter applied to frequency setting signals via external voltage/current input.

Parameter No.	Function name	Data	Default setting	Unit
A016	O, OI sampling	1. to 17.	8.	-
Related parameters		A011 to A016, C001 to C005		

- Helps remove noise in the frequency setting circuit.
- Set a larger data value if stable operation cannot be secured because of noise.
Note that the larger the data value is, the slower the response time.
- In case of setting "17", it indicates the setting of 16 moving average calculation disregarding the voltage fluctuation equivalent to 0.1 Hz. Though the frequency becomes less likely to fluctuate, the resolution for analog input decreases. This setting is not suitable for equipment that requires rapid response.

Multi-step Speed Operation Function

Set different RUN speeds by using codes and switch the set speed via the terminal.

Parameter No.	Function name	Data	Default setting	Unit
A020	Multi-step speed reference 0	0.0/Starting frequency to Max. frequency [A004]	6.0	Hz
A220	*2nd multi-step speed reference 0			
A021	Multi-step speed reference 1		0.0	
A022	Multi-step speed reference 2			
A023	Multi-step speed reference 3			
A024	Multi-step speed reference 4			
A025	Multi-step speed reference 5			
A026	Multi-step speed reference 6			
A027	Multi-step speed reference 7			
A028 to A035	Multi-step speed references 8 to 15			
Related parameters		F001, C001 to C005, CF1 to CF4 inputs		
Required settings		F001, A001 = 02		

* To switch to the 2nd multi-step speed reference 0, allocate 08 (SET) to the multi-function input terminal and then turn it on.

Speed selection could be done setting this values into digital inputs parameters C001 to C005

Data	Symbol	Function name	Status	Description
02	CF1	Multi-step speed setting binary 1	ON	Binary operation 1: ON
			OFF	Binary operation 1: OFF
03	CF2	Multi-step speed setting binary 2	ON	Binary operation 2: ON
			OFF	Binary operation 2: OFF
04	CF3	Multi-step speed setting binary 3	ON	Binary operation 3: ON
			OFF	Binary operation 3: OFF
05	CF4	Multi-step speed setting binary 4	ON	Binary operation 4: ON
			OFF	Binary operation 4: OFF

- By allocating 02 to 05 (CF1 to CF4) to any of the multi-function inputs, you can select the multi-step speed from 0 to 15. Note that multi-step speed terminals not allocated to any multi-function input are regarded as "OFF". (e.g., if 02 (CF1) and 03 (CF2) are allocated to multi-function input, the available multi-step speeds should be 0 to 3.)
- For speed 0, you can change the frequency reference with the frequency reference selection (A001). (e.g., if the frequency reference is set to the control terminal block (terminal, A001: 01), you can change it via input terminals O and OI.)
- For speed 0, use A020/A220 if the frequency reference is set to the Digital Operator (A001: 02).
- You can also select a multi-step speed by turning on/off the multi-step speed terminals (CF1 to CF4) and set the multi-step speed frequency with F001.

Multi-step speed	Multi-step speed terminals				Reflected speed	
	CF4	CF3	CF2	CF1		
0th	0	0	0	0	Reference source according to the A001 setting	
1st				1		
2nd			1	0		A022
3rd				1		A023
4th		1	0	0		A024
5th				1		A025
6th			1	0		A026
7th				1		A027
8th	1	0	0	0	A028	
9th				1	A029	
10th			1	0	A030	
11th				1	A031	
12th		1	0	0	A032	
13th				1	A033	
14th			1	0	A034	
15th				1	A035	

Jogging Operation Function

The motor rotates while the input is turned ON..

Parameter No.	Function name	Data	Default setting	Unit
A038	Jogging frequency	0.00/Starting frequency to 9.99	6.00	Hz
A039	Jogging stop selection	00: Free-run stop 01: Deceleration stop 02: DC injection braking stop	00	
Related parameters		C001 to C005, JG input		
Required settings		A002 = 01, A038 > b082, A038 > 0, A039		

- The Inverter runs at the speed set in A038 while the JG terminal allocated to one of the multi-function input terminals is turned on. Stop selection is also available in A039. Jog can be assigned to any of the multifunction inputs setting this value into C001 to C005.

Data	Symbol	Function name	Status	Description
06	JG	Jogging operation	ON	Operates at the set jogging frequency.
			OFF	Stop
Related parameters		C001 to C005		

- If the frequency is set to a higher value, the jogging operation may easily lead to a trip. Adjust A038 so that the Inverter does not trip.

(When A039 = 01)

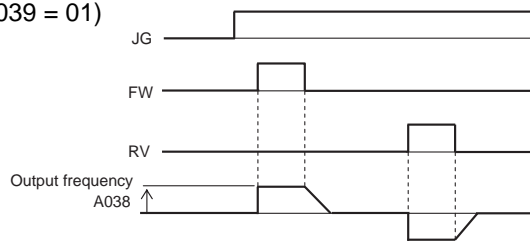

- Note 1: To perform the jogging operation, turn on the JG terminal before the FW or RV terminal. (Do the same if the RUN command source is set to the Digital Operator.)

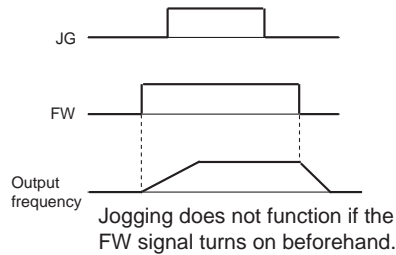

- Note 2: If A039 is set to 02, set the DC injection braking.

Relation Between Torque Boost and V/f Characteristics

Determine the relation of output voltage against output frequency.

Parameter No.	Function name	Data	Default setting	Unit
A041	Torque boost selection	00: Manual torque boost	00	—
* A241	2nd torque boost selection	01: Automatic (simple) torque boost		
A042	Manual torque boost voltage	0.0 to 20.0	1.8	%
* A242	2nd manual torque boost voltage	(Ratio to the value of AVR voltage selection A082)	0.0	
A043	Manual torque boost frequency	0.0 to 50.0	10	%
* A243	2nd manual torque boost frequency	(Ratio to base frequency)	0.0	
A044	V/f characteristics selection	00: Constant torque characteristics (VC)	00	—
* A244	2nd V/f characteristics selection	01: Reduced torque characteristics (VP 1.7th power) 06: Special reduced torque characteristics (Special VP)		
A045	Output voltage gain	20. to 100.	100.	%
A245	2nd output voltage gain			
Related parameters		A082, H003/H203, H004/H204		

* To switch to the 2nd control, allocate 08 (SET) to the multi-function input terminal and then turn it on.

■ Control Method (V/f Characteristics)

Constant Torque Characteristics (VC)

- Output voltage is proportional to output frequency. While proportional from 0 Hz to base frequency, the output voltage is constant from base to maximum frequencies regardless of the frequency.

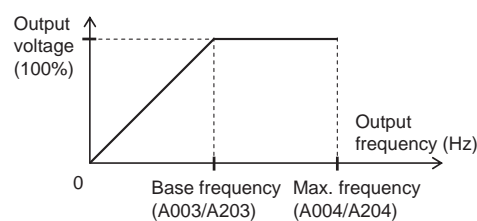

Reduced Torque Characteristics (VP 1.7th power)

- Suitable for a fan or pump that does not require large torque in a low speed range. These provide high efficiency, reduced noise and vibration, owing to reduced output voltage in a low speed range.

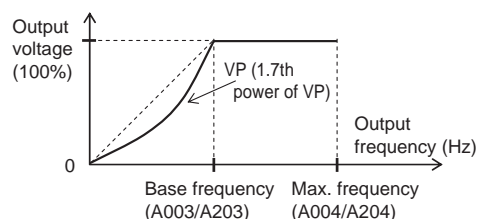

Special Reduced Torque Characteristics (Special VP)

- Suitable for a fan or pump that requires torque in a low speed range using VC characteristics at this area..

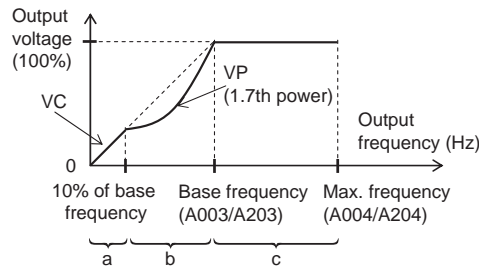

- Period a Provides constant torque characteristics (VC) within a range from 0 Hz to 10% of base frequency. (Example) If the base frequency is 50 Hz, the Inverter provides constant torque characteristics within a range from 0 to 5 Hz.
- Period b Provides reduced torque characteristics within a range from 10% to 100% of the base frequency. The Inverter outputs voltage based on a curve of the 1.7th power of the frequency.
- Period c Provides constant voltage within a range from the base frequency to the maximum frequency.

■ Torque Boost

This function helps to compensate insufficient motor torque in a low speed range.

- Compensates the voltage drop caused by the primary resistance of the motor or wiring increasing the torque in low speed range.
- To select the simple torque boost in the torque boost selection (A041/A241), set the motor capacity selection (H003/H203) and motor pole number selection (H004/H204) according to your motor.

Manual Torque Boost [A042/A242, A043/A243]

- Adds the voltage set in A042/A242 and A043/A243 to the V/f characteristics, and outputs the resulting voltage. The addition value is set in percentage terms based on the AVR voltage selection (A082) as 100%.
- The manual torque boost frequency (A043/A243) is set in percentage terms based on the base frequency as 100%.

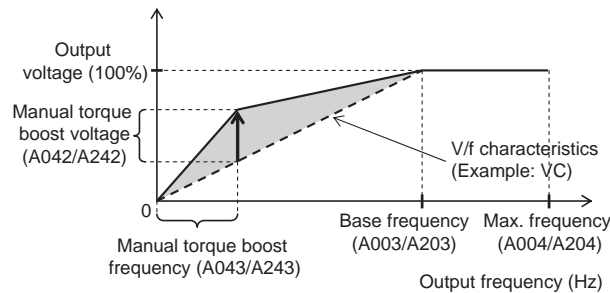

- If you raise the set value of the manual torque boost (A042/A242) be careful about motor overexcitation. Otherwise the motor may burn out.

Simple Torque Boost [A041/A241]

- If simple torque boost is selected in the torque boost selection (A041/A241: 01), it operates to adjust the output voltage depending on the load level.
- To select simple torque boost in the torque boost selection (A041/A241), set the motor capacity selection (H003/H203) and motor pole number selection (H004/H204) according to your motor.
- You may avoid a possible overcurrent trip during deceleration by always setting the AVR selection to ON (A081: 00).
- Sufficient characteristics may not be obtained if you select two or more lower rank motor size than specified.

■ Output Voltage Gain

- Changes the Inverter output voltage in percentage terms based on the AVR voltage selection [A082] as 100%.
- The Inverter cannot output voltage beyond that of the incoming voltage.

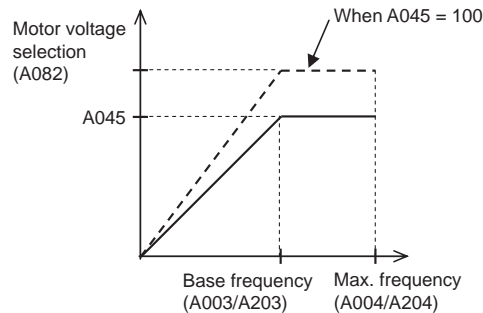

DC Injection Braking (DB)

This function securely stops the motor rotation during deceleration.

Parameter No.	Function name	Data	Default setting	Unit
A051	DC injection braking selection	00: Disabled 01: Enabled 02: DB when output frequency < A052	00	—
A052	DC injection braking frequency	0.0 to 60.0	0.5	Hz
A053	DC injection braking delay time	0.0 to 5.0	0.0	s
A054	DC injection braking power	0. to 100.	50	%
A055	DC injection braking time	0.0 to 60.0	0.5	s
A056	DC injection braking method selection	00: Edge operation 01: Level operation	01	—
Related parameters		C001 to C005		

- Two methods are available for DC injection braking: One is the external method via the multi-function input (external DC injection braking); the other is the internal method performed automatically to stop the motor (internal DC injection braking).
 - Below are operation types:
 - Edge operation: DB operates during the specified time period from the DB signal input.
 - Level operation: DB operates while a signal is being input.
 - Frequency control mode: DB operates when the frequency reaches the specified level during operation.
 - If DC injection braking operates at a high motor speed, an overcurrent trip (E01 to E04) or overload trip (E05) may occur. For internal DC injection braking, the following adjustment may help you avoid such a situation:
 - Lower the DC injection braking frequency (A052).
 - Increase the DC injection braking delay time (A053)
- For external DC injection braking via the multi-function input, use the external DC injection braking terminal (along with deceleration stop).

External DC Injection Braking (A051 = 00)

- Allocate 07 (DB) to the desired multi-function input. DC injection braking can be applied by turning on/off the DB terminal, regardless of the DC injection braking selection (A051).

Data	Symbol	Function name	Status	Description
07	DB	External DC injection braking	ON	DC injection braking is performed during deceleration.
			OFF	DC injection braking is not performed during deceleration.
Related parameters		C001 to C005		

- Set the DC injection braking power in A054.
- If the DC injection braking delay time (A053) is set, the Inverter output will be shut off during the specified time period and the motor goes into free-run status. After the set time elapses, DC injection braking starts.
- Set the DC injection braking time (A055) or the DB setting while taking into account motor heat generation. Long continuous use of DB may cause the motor to burn out.
- Perform each setting according to your system after selecting the level or edge operation in A056

4
Functions

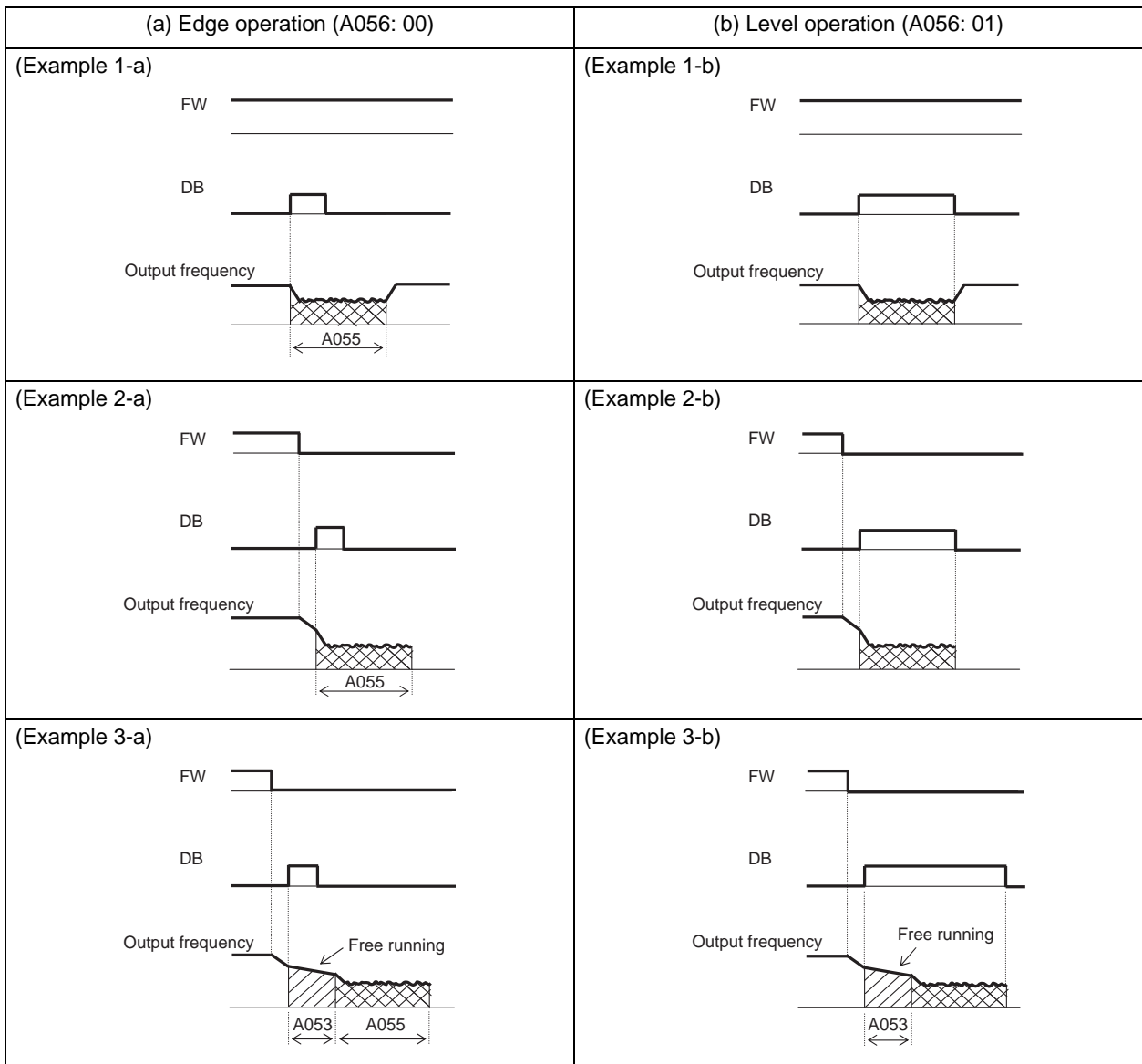

Internal DC Injection Braking (A051 = 01)

- Performs DC injection braking to stop the motor without any terminal operation.
To use this function, set the DC injection braking selection (A051) to 01.
- Set the DC injection braking power in A054.
- Set the frequency for starting DC injection braking in A052.
- If the DC injection braking delay time (A053) is set, the output is shut off when the frequency reaches the level set in A052 during deceleration, and free-run status arises for the specified period. DC injection braking starts after the set time elapses.
- Below are edge/level operations in internal DC injection braking.

Edge operation: Giving priority to the DC injection braking time (A055), performs DC injection braking for the specified period.

DC injection braking is activated for the set time in A055 when the output frequency reaches the set value in A052 after RUN command (FW) is turned off. Even if the RUN command is turned on during DC injection braking, the latter is effective during the set time in A055.

(Example 4-a), (Example 5-a)

Level operation: Giving priority to the RUN command, shifts to normal operation, ignoring the DC injection braking time (A055).

If the RUN command is turned on during DC injection braking, returns to normal operation, ignoring the set time in A055.

(Example 4-b), (Example 5-b)

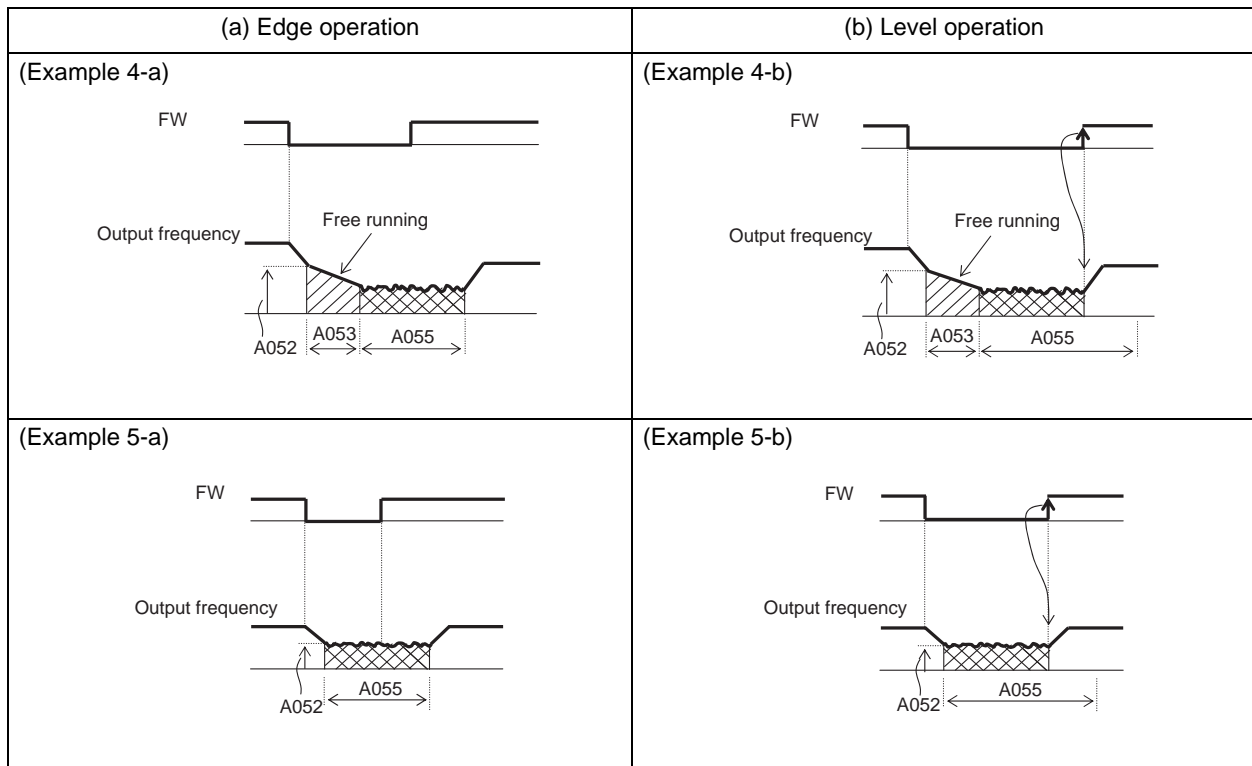

Internal DC Injection Braking (Operates Only at the Set Frequency: A051 = 02)

DC injection braking is enabled when the output frequency becomes lower than the DC injection braking frequency (A052) during operation.

- Neither external (A051 = 00) nor internal (A051 = 01) DC injection braking is available while this function is selected.
- Operates only when the RUN command is on.
- DC injection braking starts when both the reference and current frequencies become lower than A052. (Example 6-a)

- When the reference frequency reaches 2 Hz or higher than the set value in A052, DC injection braking is released and the output returns to normal. (Example 6-a)
- If the reference frequency is "0" when the operation starts with analog input, the initial operation is DC injection braking because both the reference and current frequencies are "0". (Example 6-b)
- If the RUN command is turned on with the frequency reference established (or a value larger than the A052 setting is input), the initial operation is normal output.

(Example 6-a)

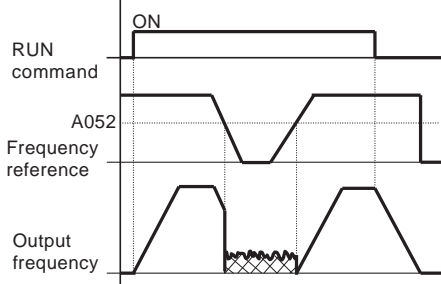

(Example 6-b)

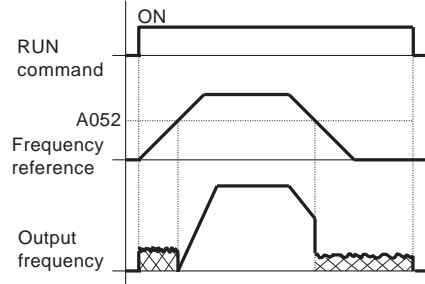

- The operation to return to normal varies depending on the setting of the DC injection braking method selection (A056).

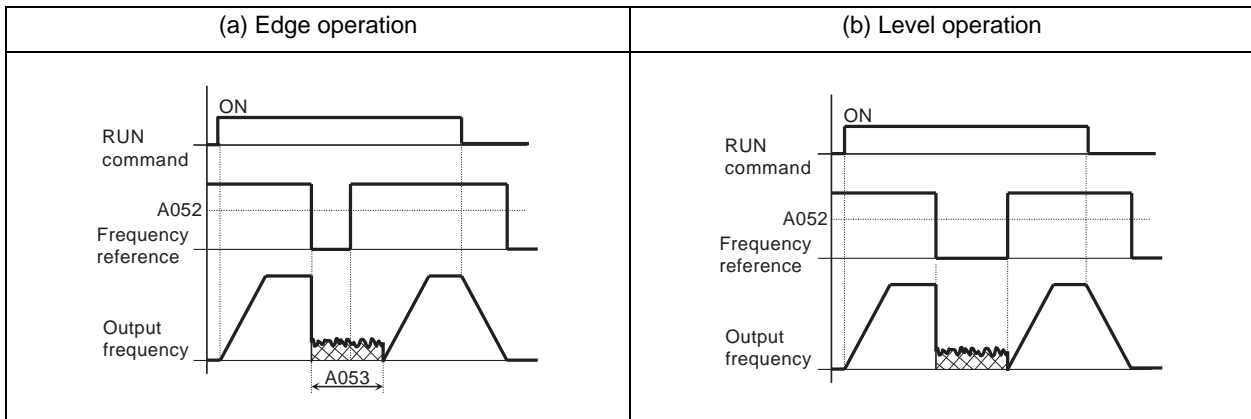

.Frequency Limit

This function limits the Inverter output frequency.

Parameter No.	Function name	Data	Default setting	Unit
A061	Frequency upper limit	0.0/Frequency lower limit [A062] to Max. frequency [A004]	0.0	Hz
* A261	2nd frequency upper limit	0.0/Frequency lower limit [A262] to Max. frequency [A204]	0.0	
A062	Frequency lower limit	0.0/Starting frequency to Frequency upper limit [A061]	0.0	
* A262	2nd frequency lower limit	0.0/Starting frequency to Frequency upper limit [A261]	0.0	
Related parameters		C001 to C005		

* To switch to the 2nd control, allocate 08 (SET) to the multi-function input terminal and then turn it on.

- You can set both upper/lower limits to the set frequency. This function does not accept any frequency reference beyond the set limits.
- Set the upper limit first.
Make sure the upper limit (A061/A261) is higher than the lower limit (A062/A262).
- Neither limit would work if set to 0 Hz.

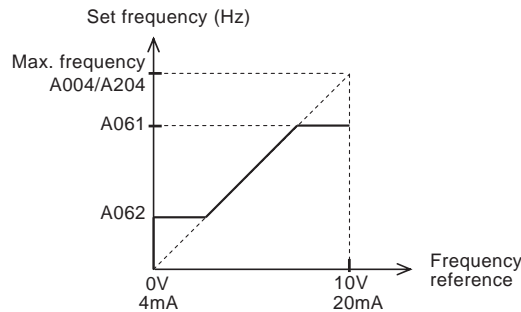

If the lower limit is set, the set value is prioritized even if 0 V (4 mA) is input for frequency reference.

Frequency Jump Function

This function helps avoid resonant points of loaded machines.

Parameter No.	Function name	Data	Default setting	Unit
A063 A065 A067	Jump frequency 1 Jump frequency 2 Jump frequency 3	0.0 to 400.0	0.0	Hz
A064 A066 A068	Jump frequency width 1 Jump frequency width 2 Jump frequency width 3	0.0 to 10.0	0.5	
Related parameters		C001 to C005		

- The output frequency cannot be set within the frequency range set in the frequency jump function.
- The output frequency only pass through the jump frequency during acceleration and deceleration process, but if the frequency reference is set inside this area the output will move automatically out of this jump area setting a higher or lower frequency depending if inverter is accelerating or decelerating.

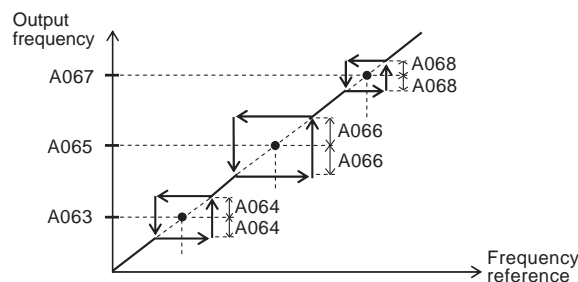

PID Function

This function enables process control of such elements as flow rate, air volume, and pressure.

Parameter No.	Function name	Data	Default setting	Unit
A071	PID selection	00: Disabled 01: Enabled	00	—
A072	PID P gain	0.2 to 5.0	1.0	—
A073	PID I gain	0.0 to 150.0	1.0	s
A074	PID D gain	0.00 to 100.0	0.0	s
A075	PID scale	0.01 to 99.99	1.00	Time
A076	PID feedback selection	00: OI 01: O 02: RS485 communication 03: Operation function output	00	—
A077	Reverse PID function	00: Deviation = Target value - Feedback value 01: Deviation = Feedback value - Target value	00	—
A078	PID output limit function	0.00 to 100.0	0.0	%
C044	PID deviation excessive level	0. to 100.	3.0	%
C052	PID FB upper limit	0.0 to 100.0	100	%
C053	PID FB lower limit		0.0	%
Related parameters		d004, A001, A005, C001 to C005, C021, C026		

- To use this function, set A071 to 01.
- To switch between enable/disable via the terminal block (external signal), allocate 23 (PID enable/disable) to the desired multi-function input. Select OFF for enable and ON for disable.

Basic Structure of PID Control (Example)

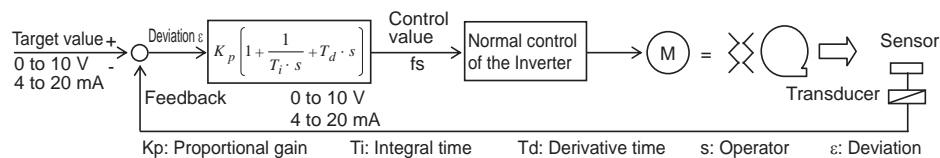

PID Enable/Disable

The PID enable/disable function disables the PID function temporarily through terminal input. This overrides the A071 setting to control the motor frequency.

Data	Symbol	Function name	Status	Description
23	PID	PID enabled/disabled	ON	Disables the PID function.
			OFF	Does not affect the PID function.
Related parameters		C001 to C005		

Target Value Selection

- The target value depends on the terminal selected in frequency reference A001 other than that in A076.
- You cannot set analog inputs O and OI to both target and feedback values simultaneously. Do not connect the signal lines for inputs O and OI simultaneously.

Feedback Selection

- Select a terminal for feedback signals in A076.
- The setting of O/OI terminal selection A005 is disabled when the control terminal block (terminal) 01 is set in A001.

PID Feedback Value Monitor

- You can monitor the PID feedback value in d004.
- The monitor value is displayed as the multiplied value of the PID scale (A075).
Monitor display = Feedback value (%) × A075 setting

Excessive Deviation/Output

- You can set the PID deviation excessive level (C044) during PID control. If the PID deviation reaches the PID deviation excessive level (C044), the multi-function output terminal is turned on.

Parameter No.	Function name	Data	Default setting	Unit
C044	PID deviation excessive level	0.0 to 100.0	3.0	%

- Allocate 04 (OD) to any of the multi-function output terminal 11 selection (C021) or relay output (AL2, AL1) function selection (C026)..

Data	Symbol	Function name	Status	Description
04	OD	Excessive PID Deviation	ON	The PID deviation has exceeded the C044 set value.
			OFF	The PID deviation has not reached the C044 set value.
Available output terminals		11-CM2, AL2-AL0 (or AL1-AL0)		
Required settings		C021, C026, C044		

- C044 can be set from 0 to 100. Setting corresponds to the range of 0 to the maximum target value.

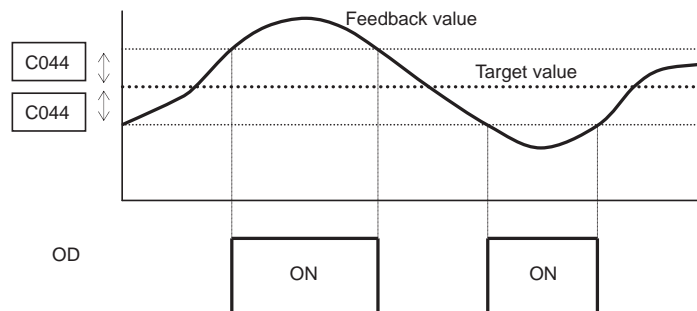

■PID Feedback (FB) Upper/Lower Limit

If the feedback value exceeds the upper limit set in C052, FBV, which is allocated to the multi-function output terminal, turns on. If the value falls below the lower limit set in C053, FBV turns off. This is effective as a RUN command in operating multiple pumps.

Data	Symbol	Function name	Status	Description
07	FBV	PID FB status output	ON	See the figure below. Shifts output when exceeding the upper limit or falling below the lower limit.
			OFF	
Available output terminals		11-CM2, AL2-AL0 (or AL1-AL0)		
Required settings		C021, C026, C052, C053		

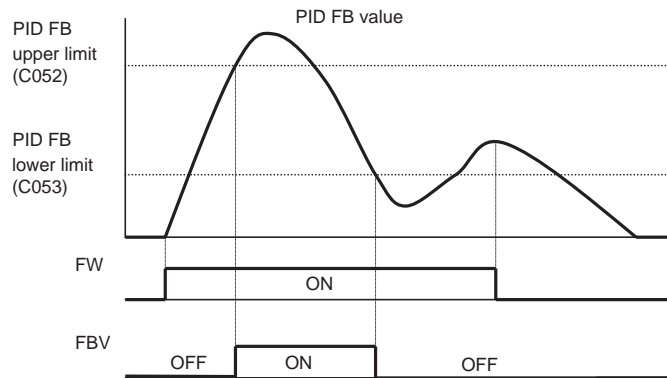

■PID Operation P Operation

•Operation where the control volume is proportional to the target value

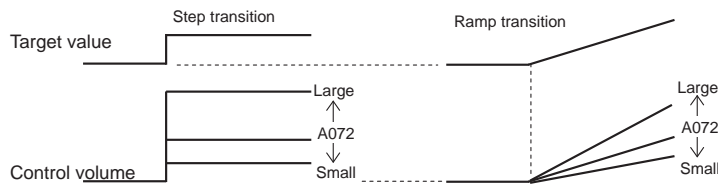

I Operation

•Operation where the control volume increases linearly according to time

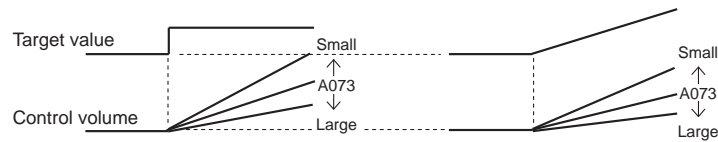

D Operation

•Operation where the control volume is proportional to the variation ratio of the target value

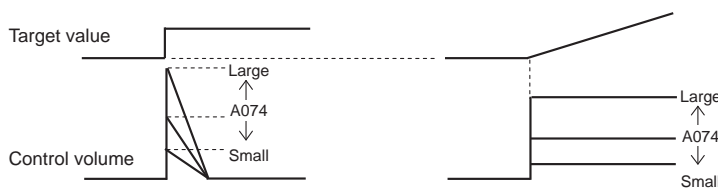

•PI operation is the combination of the above P and I operations; PD is P and D operations; PID is P, I and D operations.

4

Functions

■PID Gain Adjustment

- If a stable response cannot be obtained in PID function operation, adjust each gain as follows according to the situation.

Feedback value variation is slow when the target value is changed.	→ Raise P gain.
The feedback value changes fast but isn't stable.	→ Lower P gain.
The target and feedback values wouldn't match smoothly.	→ Lower I gain.
The feedback value fluctuates unstably.	→ Raise I gain.
Response is slow even with P gain raised.	→ Raise D gain.
With P gain raised, the feedback value fluctuates and isn't stable.	→ Lower D gain.

■PID Integral Reset

- Clears the integral value of PID operation.
- Allocate 24 (PIDC) to the desired multi-function input..

Data	Symbol	Function name	Status	Description
24	PIDC	PID integral reset	ON	Forcibly sets the PID integral value to zero.
			OFF	Does not affect the PID function
Related parameters		C001 to C005		

- Clears the integral value every time the PIDC terminal is turned on.
Do not turn on the PIDC terminal during PID operation to avoid an overcurrent trip.
Turn on the PIDC terminal after turning off PID operation, this will help to stop the motor.
The integral value is cleared during free running or retry.l

■PID Comparison Function

- This function outputs a signal when detecting that the PID feedback value exceeds the set range.
- Allocate 07 (FBV) to any of multi-function output terminal 11 (C021) or relay output terminals AL2 and AL1 (C026).
- Set the upper limit in C052, and the lower limit in C053. When the PID feedback value falls below the lower limit, the terminal is turned on. The ON state will remain until the value exceeds the upper limit.
- The output signal is turned off while output is shut off (during stop or FRS, etc.).
- Helps control the number of fans and pumps.

AVR Function

- This function outputs voltage to the motor correctly even if the incoming voltage to the Inverter fluctuates. With this function, output voltage to the motor is based on that set in the AVR voltage selection.

Parameter No.	Function name	Data	Default setting	Unit
A081	AVR selection	00: Always ON 01: Always OFF 02: OFF during deceleration	02	—
A082	AVR voltage selection	200-V class: 200/215/220/230/240 400-V class: 380/400/415/440/460/480	200/400	—
Related parameters		d004, A001, A005		

- With A081 (AVR selection), set whether to enable or disable this function.
- Note that the Inverter cannot output voltage beyond that of the incoming voltage.
- To avoid a possible overcurrent trip during deceleration, set the AVR selection to "Always ON" (A081: 00).

Parameter No.	Data	Description	Note
A081	00	Always ON	Enabled during acceleration, constant speed operation, and deceleration.
	01	Always OFF	Disabled during acceleration, constant speed operation, and deceleration.
	02	OFF during deceleration	Disabled only during deceleration in order to reduce the energy regenerated to the Inverter by increasing the motor loss. This will avoid a possible trip due to regeneration during deceleration.

Automatic Energy-saving Operation Function

This function automatically adjusts the Inverter output power to a minimum during constant speed operation. This is suitable for the load of reduced torque characteristics, such as a fan and pump.

Parameter No.	Function name	Data	Default setting	Unit
A085	RUN mode selection	00: Normal operation 01: Energy-saving operation	00	—
A086	Energy-saving response/accuracy adjustment	0 to 100%	50	%

- To operate with this function, set the RUN mode selection (A085) to 01. You can adjust the response and accuracy in the energy-saving response/accuracy adjustment (A086).
- Controls the output power at a comparatively slow rate. If rapid load fluctuation like impact load occur the motor may stall resulting in an overcurrent trip.

Parameter No.	Data	Response	Accuracy	Energy-saving effect
A086	0	Slow	High	Small
	100	Fast	Low	Large

2-step Acceleration/Deceleration Function

This function changes the acceleration/deceleration time during such operations.

Parameter No.	Function name	Data	Default setting	Unit
A092	Acceleration time 2	0.01 to 99.99 100.0 to 999.9	10.0	s
* A292	2nd acceleration time 2	1000. to 3000.	10.0	s
A093	Deceleration time 2	0.01 to 99.99 100.0 to 999.9	10.0	s
* A293	2nd deceleration time 2	1000. to 3000.	10.0	s
A094	2-step acceleration/ deceleration selection	00: Switched via multi-function input 09 (2CH) 01: Switched by setting	00	—
* A294	2nd 2-step acceleration/ deceleration selection	00: Switched via multi-function input 09 (2CH) 01: Switched by setting	00	—
A095	2-step acceleration frequency	0.0 to 400	0.0	Hz
* A295	2nd 2-step acceleration frequency	0.0 to 400	0.0	Hz
A096	2-step deceleration frequency	0.0 to 400	0.0	Hz
* A296	*2nd 2-step deceleration frequency	0.0 to 400	0.0	Hz
Related parameters		F002, F003, F202, F203, C001 to C005		

- * To switch to the 2nd control, allocate 08 (SET) to the multi-function input terminal and then turn it on.
- The acceleration/deceleration time can be switched via the multi-function input terminal or automatically with an arbitrary frequency.
 - To switch via the multi-function input terminal, allocate 09 (2CH) to it.

Data	Symbol	Function name	Status	Description
09	2CH	2-step acceleration/deceleration	ON	Enables the 2-step acceleration/ deceleration time.
			OFF	Disables the 2-step acceleration/ deceleration time.
Related parameters		C001 to C005		
Required settings		A094 = 00		

(Example 1) When A094/A294 is set to 00

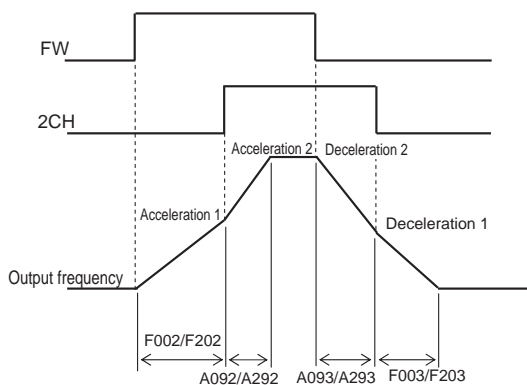

(Example 2) When A094/A294 is set to 01

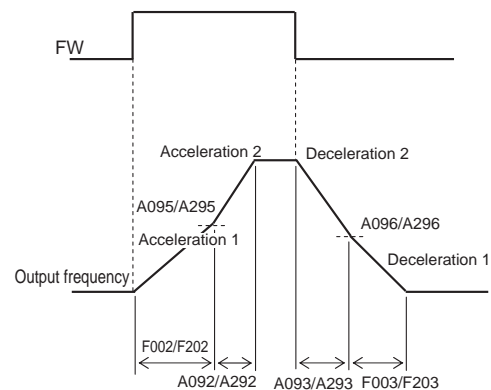

Acceleration/Deceleration Pattern

This function is used when smooth acceleration/deceleration is needed.

Parameter No.	Function name	Data	Default setting	Unit
A097	Acceleration pattern selection	00: Line 01: S-shape curve	00	—
A098	Deceleration pattern selection	00: Line 01: S-shape curve	00	—

•Acceleration/deceleration pattern can be set according to each system.

4

Functions

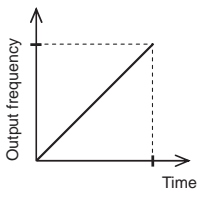
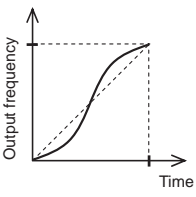
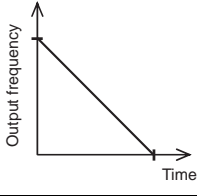
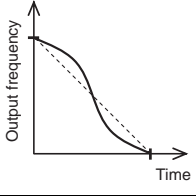
Parameter No.	Set value	
	00	01
	Line	S-shape curve
A097 (Acceleration)		
A098 (Deceleration)		
Description	Accelerates/Decelerates linearly before reaching the set output frequency value.	Helps prevent the collapse of cargo on the elevating machine or conveyor.

External Frequency Adjustment Function (OI)

Parameter No.	Function name	Data	Default setting	Unit
A101	OI start frequency	0.00 to 400.0	0.0	Hz
A102	OI end frequency	0.00 to 400.0	0.0	Hz
A103	OI start ratio	0. to 100.	0.	%
A104	OI end ratio	0. to 100.	100.	%
A105	OI start selection	00: External start selection 01: 0 Hz	01	—
Related parameters		A005, A011 to A015, A016, A151 to A155, AT input		

For each item, refer to "External Frequency (Voltage/Current) Adjustment" (page 4-11).

Operation Frequency Function

This function makes calculations for two inputs and reflects the result as the output frequency.

Parameter No.	Function name	Data	Default setting	Unit
A141	Operation frequency input A setting	00: Digital Operator (F001) 01: Digital Operator (FREQ adjuster) 02: Input O 03: Input OI 04: RS485 communication	01	—
A142	Operation frequency input B setting		02	—
A143	Operator selection	00: Addition (A + B) 01: Subtraction (A - B) 02: Multiplication (A × B)	00	—
Related parameters		A001 = 10		

- Inputs O and OI cannot be set simultaneously. Do not connect the signal lines for inputs O and OI simultaneously.

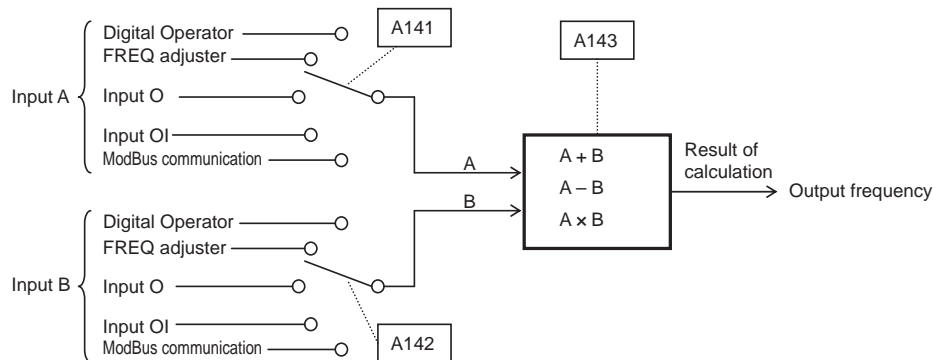

Frequency Addition Function

This function adds or subtracts the constant frequency set in A145 to/from the output frequency. Select addition or subtraction in A146.

Parameter No.	Function name	Data	Default setting	Unit
A145	Frequency addition amount	0.0 to 400.0	0.0	Hz
A146	Frequency addition direction	00: Adds the A145 value to the output frequency 01: Subtracts the A145 value from the output frequency	00	—

TAllocate 50 to multi-function input terminal on parameter C001 to C005 to use this functions.

Data	Symbol	Function name	Status	Description
50	ADD	Frequency addition	ON	Calculates the set value in A145 against the set frequency in A001 according to the formula specified in A146, in order to provide a new frequency reference.
			OFF	Normal control
Related parameters		C001 to C005		
Related codes		A001, A002		

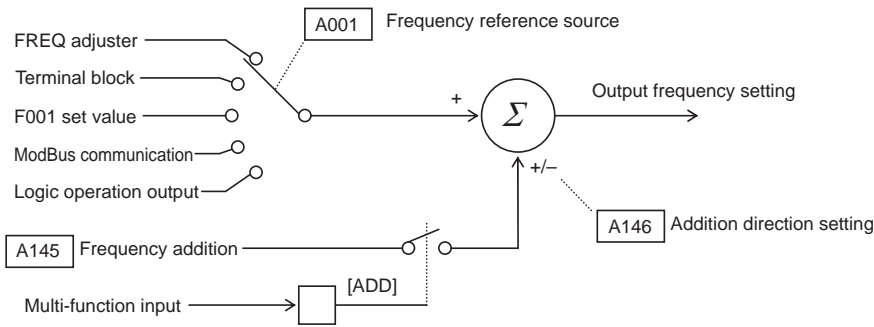

<Group B: Detailed Function Parameter>

Momentary Power Interruption/Trip Retry (Restart)

This function allows you to determine the operation performed when a trip occurs due to momentary power interruption, undervoltage, overcurrent, or overvoltage. Set the retry condition according to your system.

Parameter No.	Function name	Data	Default setting	Unit
b001	Retry selection	00: Outputs an alarm after a trip. 01: Restarts from 0 Hz at retry. 02: Matches the frequency at retry and starts. 03: Starts the Active Frequency Matching retry and trips after deceleration stop.	00	—
b002	Allowable momentary power interruption time	0.3 to 25.0 Trips if the momentary power interruption is within the set time. If not, it restarts.	1.0	s
b003	Retry wait time	0.3 to 100.0 Time from recovery to restart	1.0	s
b004	Momentary power interruption/undervoltage trip during stop selection	00: Disabled 01: Enabled	00	—
b005	Momentary power interruption retry time selection	00: 16 times 01: No limit	00	—
b011	Starting frequency at Active Frequency Matching restart	00: Frequency at interruption 01: Max. frequency 02: Set frequency	00	—
b029	Deceleration rate constant at frequency Active Frequency Matching restart	0.1 to 3000.0	0.5	s
b030	Frequency Active Frequency Matching restart level	0.2 × Rated current to 2.0 × Rated current	Rated current	A
Related parameters		C021, C026		

■ Trip Retry Function

- Select the retry function during operation in [b001] (01 or 02). If [b005] is 00 (default), the following operations are to be performed.

At the time of momentary power interruption and undervoltage:

Restarts 16 times and trips on the 17th time.

At the time of overcurrent and overvoltage:

Restarts 3 times respectively and trips on the 4th time.

Retry times are counted separately for momentary power interruption, undervoltage, overcurrent, and overvoltage. For example, an overvoltage trip occurs only after 3-time overcurrent trips and then 4-time overvoltage trips. For momentary power interruption and undervoltage, if [b005] is set to 01, the retry operation continues until the status is cleared.

- You can select the operation for momentary power interruption and undervoltage during stop in b004.

(Supplemental Information)

Frequency matching start: Restarts the motor without stopping it after matching the motor rotation speed. (If the RUN command is set on the Digital Operator (A002 = 2), the Inverter stops.)

- Below is the timing chart where the retry function (b001: 02) is selected.

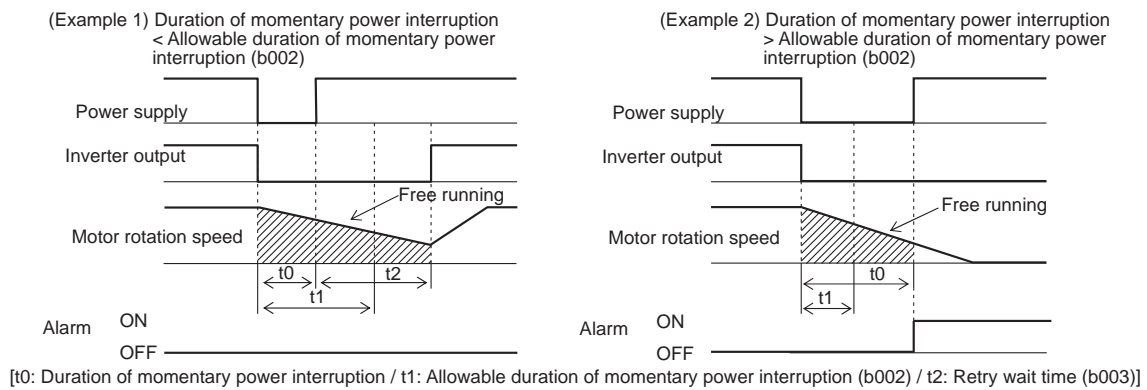

■ Alarm Selection for Momentary Power Interruption/Undervoltage During Stop

- Use b004 to select whether to enable an alarm output in case of momentary power interruption or undervoltage.
 - An alarm output continues while Inverter control power supply remains.
- Alarm output for momentary power interruption and undervoltage during stop (Examples 3 and 4)

(Example 3) b004: 00

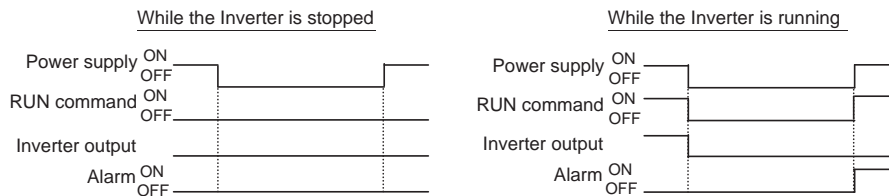

(Example 4) b004: 01

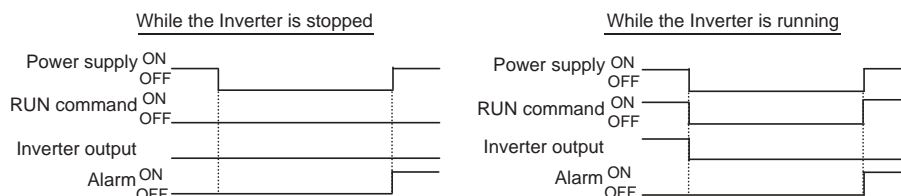

Electronic Thermal Function

This function electronically protects the motor from overheating.

- Causes an overload trip (E05) to protect the motor from overheating by setting according to the motor rated current.
- Provides the most appropriate protection characteristics, taking into account the decline of a standard motor cooling capability at a low speed.
- To set a value over the rated current of the motor, be careful of any temperature rise of the motor.

Parameter No.	Function name	Data	Default setting	Unit
b012	Electronic thermal level	0.2 × Rated current to 1.0 × Rated current	Rated current	A
* b212	2nd electronic thermal level		Rated current	A
b013	Electronic thermal characteristics selection	00: Reduced torque characteristics 1 01: Constant torque characteristics 02: Reduced torque characteristics 2	01	—
* b213	2nd electronic thermal characteristics selection		01	—
Related parameters		C021, C024		

* To switch to the 2nd control, allocate 08 (SET) to the multi-function input terminal and then turn it on.

Electronic Thermal Level (Motor Protection Level)

(Example) 3G3JX-AB007
 Rated current: 4.0 A
 Setting range: 0.8 to 4.0A

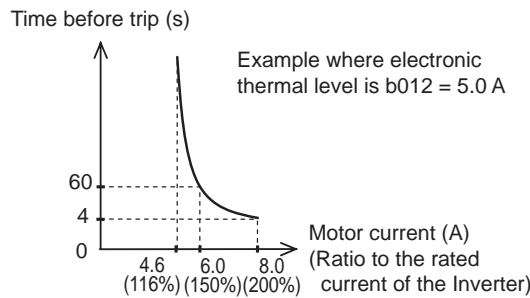

Electronic Thermal Characteristics

- Frequency characteristics are multiplied by the b012/212 set value above.
- The lower the output frequency is, the lower the cooling capability of the standard motor's self-cooling fan.

Reduced Torque Characteristics 1

- Multiplied by the time limit characteristics set in b012/212 for each frequency.

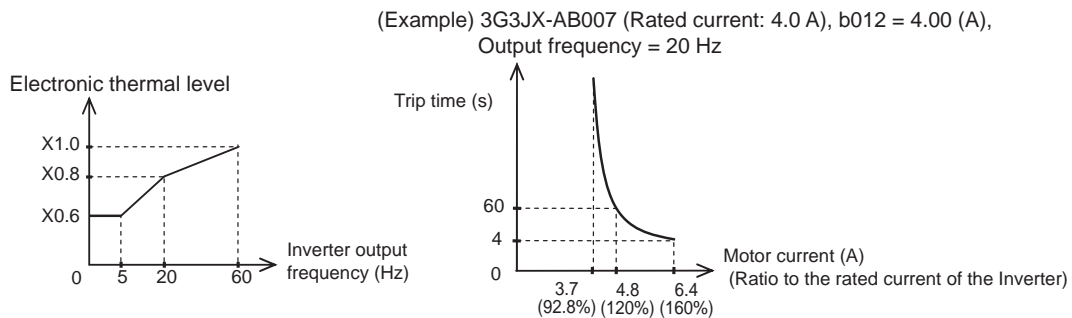

Constant Torque Characteristics

- Do not skip this setting when using a constant torque motor.
- Multiplied by the time limit characteristics set in b012/212 for each frequency.

(Example) 3G3JX-AB007 (Rated current: 4.0 A), b012 = 4.00 (A), Output frequency = 2.5 Hz

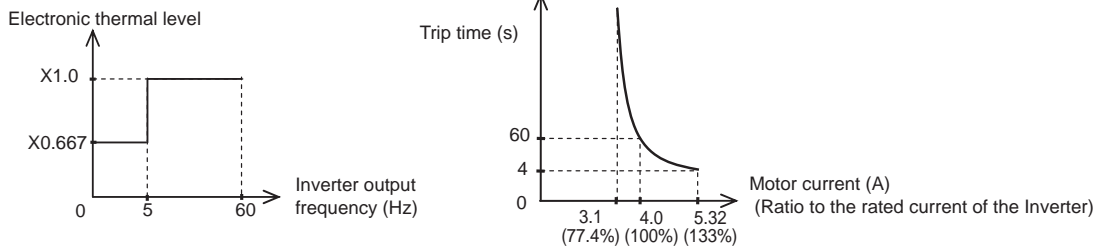

Reduced Torque Characteristics 2

- Multiplied by the time limit characteristics set in b012/212 for each frequency.

(Example) 3G3JX-AB007 (Rated current: 4.0 A), b012 = 4.00 (A), Output frequency = 40 Hz

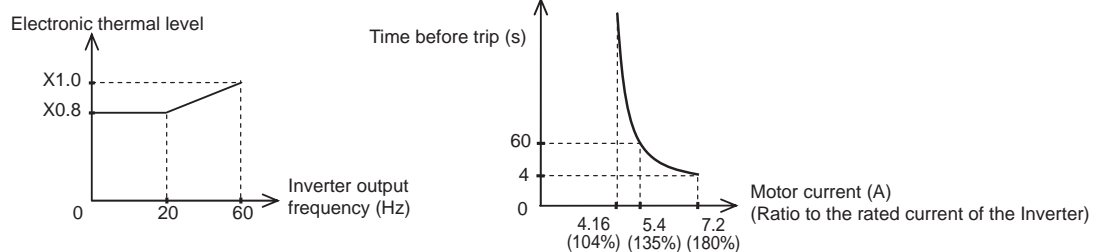

Overload Limit/Overload Warning

This function helps prevent an overcurrent trip due to rapid load fluctuation in acceleration or constant speed operation.

Parameter No.	Function name	Data	Default setting	Unit
b021	Overload limit selection	00: Disabled 01: Enable in acceleration/constant speed operation	00	—
* b221	2nd overload limit selection	02: Enabled in constant speed operation	00	—
b022	Overload limit level	0.1 × Rated current to 1.5 × Rated current	1.5 × Rated current	A
* b222	2nd overload limit level		1.5 × Rated current	A
b023	Overload limit parameter	0.1 to 3000.0 (Deceleration time while this function is in operation)	1.0	s
* b223	2nd overload limit parameter		1.0	s
b028	Overload limit source selection	00: b022, b222 set values	00	—
* b228	2nd overload limit source selection	01: Input terminal O	00	—
C041	Overload warning level	0.0: Does not operate. 0.1 × Rated current to 2.0 × Rated current (Outputs OL signal when the overload warning level is reached.)	Rated current	A
* C241	2nd overload warning level		Rated current	
Related parameters		C021, C026		

* To switch to the 2nd control, allocate 08 (SET) to the multi-function input terminal and then turn it on.

- The Inverter monitors the motor current during acceleration or constant speed operation. If it reaches the overload limit level, the output frequency is lowered automatically according to the overload limit parameter.
- The overload limit level sets a current value for this function to work.
- When this function operates, the acceleration time becomes longer than the set time.
- With the overload limit parameter set too low, an overvoltage trip may occur due to regenerative energy from the motor. This is because of automatic deceleration from this function even during acceleration.
- Make the following adjustments if this function operates during acceleration and the frequency doesn't reach the target level.
 - Increase the acceleration time.
 - Increase the torque boost.
 - Increase the overload limit level.
 - Use a higher rank Inverter.

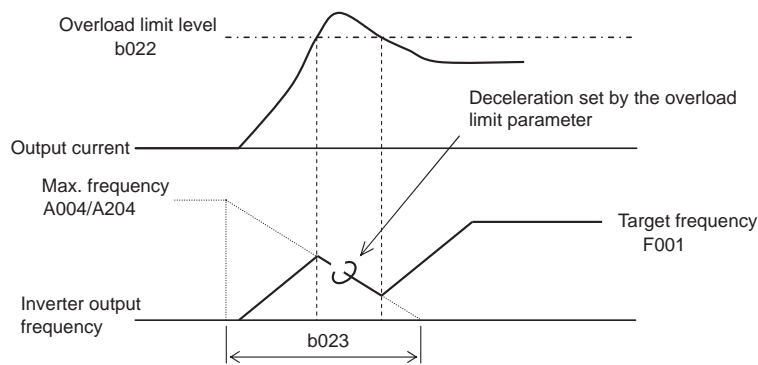

- You can change the level setting in the overload limit source selection. With 00 selected, the set values of b022 and b222 are applied to the overload limit level. With 01 selected, the analog voltage input between O and L is enabled, and 10 V here corresponds to 150% of the rated current. Note that 01 can be set only if PID is disabled and the AT terminal is not set.

Overload Warning

- If the load is too large, this function outputs an overload warning signal, allowing you to readjust the overload level. This helps prevent mechanical damage due to an overload in the conveyors, or an operation line stop due to an overload trip of the Inverter.
- Allocate 03 (OL) to any of multi-function output terminal 11 or relay output terminals..

Data	Symbol	Function name	Status	Description
03	OL	Overload warning	ON	The Inverter output current has exceeded the C041 set value.
			OFF	The Inverter output current has not reached the C041 set value.
Available output terminals		11-CM2, AL2-AL0 (or AL1-AL0)		
Required settings		C021, C026, C041		

Parameter No.	Function name	Data	Default setting	Unit
C041	Overload warning level	0.0: Does not operate. 0.1 to Rated current × 200%: Outputs OL signal when reaching the overload warning level.	Rated current	A

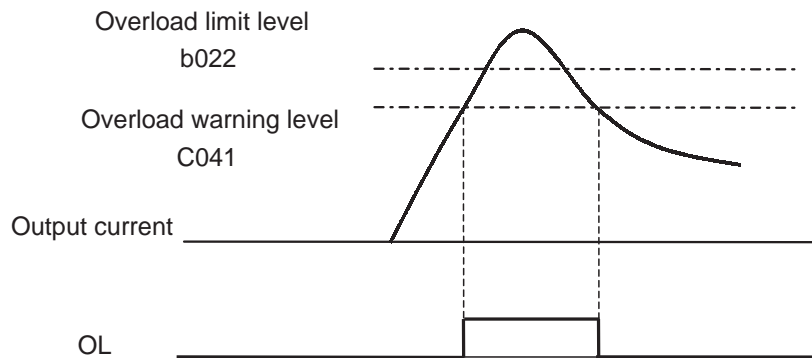

Soft Lock Function

Use this function to prohibit writing of each parameter. This helps prevent data rewrite due to erroneous operation.

For the soft lock selection through the signal input from the terminal (b031 = 00 or 01), refer to the Soft Lock Function of the Multi-function Input section in "Reset" (page 4-50).

Parameter No.	Function name	Data	Default setting	Unit
b031	Soft lock selection	00: Data other than b031 cannot be changed when terminal SFT is ON. 01: Data other than b031 and specified frequency parameters cannot be changed when terminal SFT is ON. 02: Data other than b031 cannot be changed. 03: Data other than b031 and the specified frequency parameter cannot be changed. 10: Data other than parameters changeable during operation cannot be changed.	01	—
Related parameters		SFT input		

Allocate 15 (SFT) to the desired multi-function input.

Data	Symbol	Function name	Status	Description
15	SFT	Soft lock	ON	Rewriting is unacceptable except for specified parameters.
			OFF	Depends on the b031 setting.
Related parameters		C001 to C005		
Required settings		b031 (soft lock excluded)		

Momentary Power Interruption Non-stop Function

This function decelerates the Inverter by a controlled stop to avoid a trip or free running in case of power supply disconnection or momentary power interruption during operation.

Parameter No.	Function name	Data	Default setting	Unit
b050	Selection of non-stop function at momentary power interruption	00: Disabled 01: Enabled (Stop) 02: Enabled (Restart)	00	—
b051	Starting voltage of non-stop function at momentary power interruption	0.0 to 1000.	1.0	V
b052	Stop deceleration level of non-stop function at momentary power interruption	0.0 to 1000.	0.0	V
b053	Deceleration time of non-stop function at momentary power interruption	0.01 to 99.99 100.0 to 999.9 1000. to 3000.	1.00	s
b054	Deceleration starting width of non-stop function at momentary power interruption	0.00 to 10.00	0.00	Hz

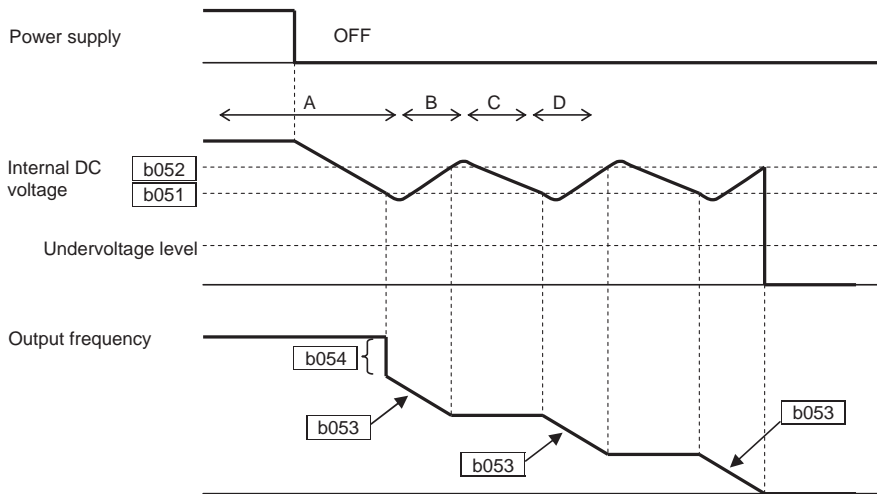

■ Operation Description

- A If the power is disconnected during operation with the momentary power interruption non-stop function enabled (b050 = 01) and the voltage falls below the momentary power interruption non-stop function starting voltage (b051), the output frequency is decelerated with one stroke in accordance with the momentary power interruption non-stop deceleration starting width (b054) (Internal DC voltage rises due to the regenerative energy generated at this time.)
- B While deceleration continues in accordance with the momentary power interruption non-stop deceleration time (b053), internal DC voltage increases, and once the voltage reaches the stop deceleration level of non-stop function (b052), deceleration ceases.
- C Internal DC voltage decreases because there is no power supply during this constant speed operation.
- D Deceleration starts again according to b053 after the internal DC voltage decreases to b051. Then, after a recurrence from B, the operation eventually stops without a trip.

If the internal DC voltage has dropped below the undervoltage level during this function, output is shut off after an undervoltage trip to enter free-run status.

(Caution)

- When the momentary power interruption non-stop deceleration level (b052) is below the momentary power interruption non-stop function starting voltage (b051), the Inverter performs this function by increasing b052 to b051 without an automatic setting change.
- This function is not reset before completion. To run the Inverter after power recovery during this function, input the RUN command after entering the STOP command when stopped.

Overvoltage Control Function During Deceleration

This function helps avoid an overvoltage trip during deceleration. Note that the actual deceleration time may be longer than the set value. This function automatically keeps DC voltage at the set level during deceleration. The aim of this function is the same as the overvoltage LAD stop function, described in b130 and b131. However, these functions have different deceleration characteristics and you can select either function according to your system

Parameter No.	Function name	Data	Default setting	Unit
b055	Overvoltage protection proportional gain during deceleration	0.2 to 5.0	0.2	—
b056	Overvoltage protection integral time during deceleration	0.0 to 150.0	0.2	s
b133	Overvoltage protection function selection during deceleration	00: Disabled 01: Enabled	00	—
b134	Overvoltage protection level setting during deceleration	200-V class: 330 to 395 400-V class: 660 to 790	380/ 760	V

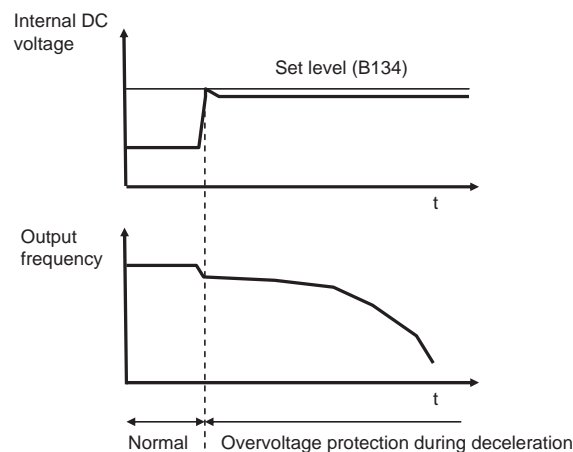

With this function activated, PI control works to keep the internal DC voltage constant.

- Though quicker response is expected with a larger proportional gain, control tends to be divergent and may easily lead to a trip.
- Response also becomes quicker with a shorter integral time, but if too short, it may lead to a trip as well.

Overvoltage LAD Stop Function

This function helps avoid an overvoltage trip due to regenerative energy from the motor during deceleration. Note that the actual deceleration time may be longer than the set value. If DC voltage exceeds the set level, the Inverter stops deceleration. The aim of this function is the same as the overvoltage control function during deceleration, described in b055 and b056. However, these functions have different deceleration characteristics and you can select either function according to your system.

Parameter No.	Function name	Data	Default setting	Unit
b130	Overvoltage LAD stop function	00: Disabled 01: Enabled	00	—
b131	Overvoltage LAD stop function level setting	200-V class: 330. to 395. 400-V class: 660. to 790.	380/760	V

- Select to enable or disable the overvoltage LAD stop function in b130.
- Adjust the overvoltage LAD stop function level in b131.
- The main circuit DC voltage rises because of regenerative energy from the motor once deceleration starts. With the overvoltage LAD stop function enabled (b130: 01), the Inverter stops deceleration temporarily once the main circuit DC voltage has reached the overvoltage LAD stop function level, which is lower than the overvoltage level. Deceleration then resumes if the voltage level falls below the overvoltage LAD stop function level.
- With the overvoltage LAD stop function enabled (b130: 01), the actual deceleration time may become longer than the set value (F003/F203).
- This function does not aim to keep the main circuit DC voltage level constant. Therefore, an overvoltage trip may occur if the main circuit DC voltage rises rapidly because of rapid deceleration.

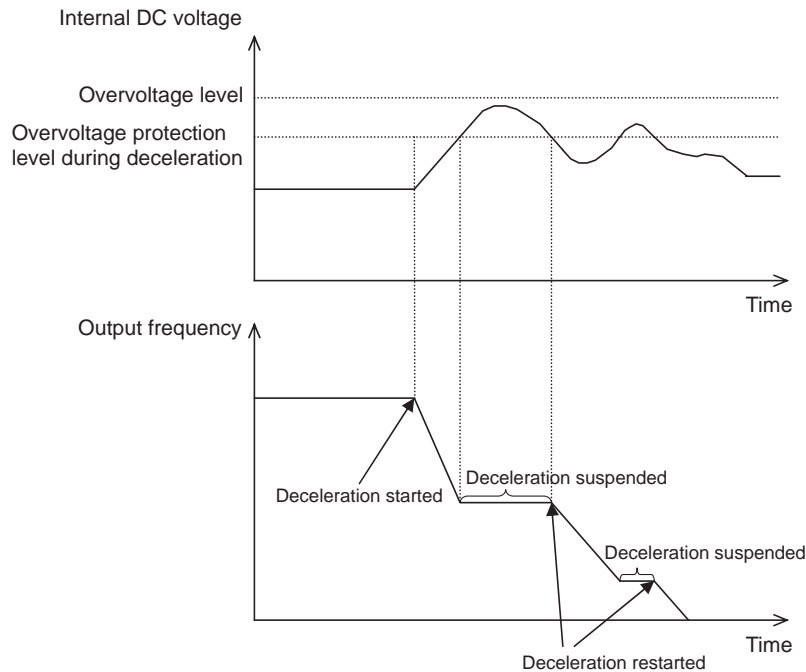

- The fluctuation of the internal DC voltage of this function is larger compared to the overvoltage control function during deceleration, described in b055, b056, b133, and b134. These functions aim to avoid overvoltage during deceleration, and you can select either function according to your system.

Starting Frequency

Set the frequency to start Inverter output with the RUN signal turned on.

Parameter No.	Function name	Data	Default setting	Unit
b082	Starting frequency	0.5 to 9.9	0.5	Hz

- Use mainly to adjust the starting torque.
- With the starting frequency set high, the starting current increases. Therefore, the current may exceed the overload limit and cause an overcurrent trip

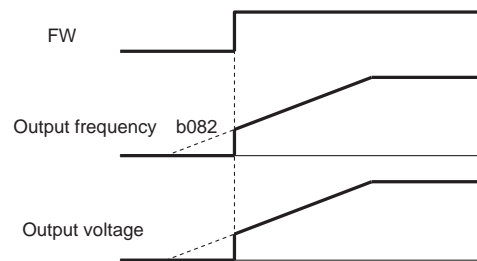

Carrier Frequency

You can change the PWM waveform carrier frequency output from the Inverter.

Parameter No.	Function name	Data	Default setting	Unit
b083	Carrier frequency	2.0 to 12.0	3.0	kHz

- With the carrier frequency set high, you can reduce metallic noise from the motor. However, this may increase electrical noise or leakage current from the Inverter.
- Carrier frequency adjustment also helps avoid mechanical or motor resonance.
- To raise the carrier frequency, reduce the output current (or derate the rated current) as shown in the graph below.

(1) Ambient temperature 40°C

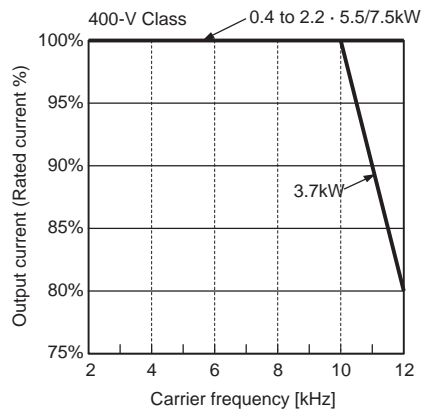
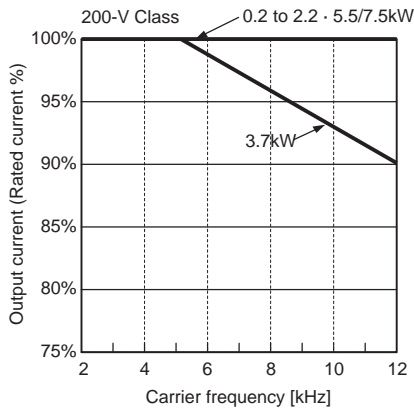

(2) Ambient temperature 50°C

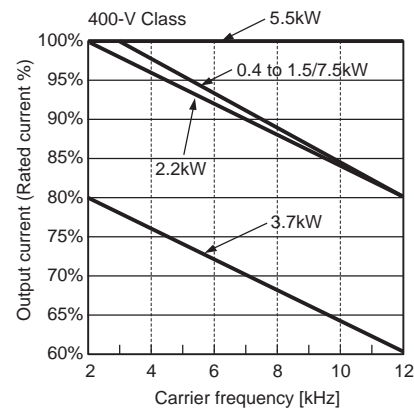
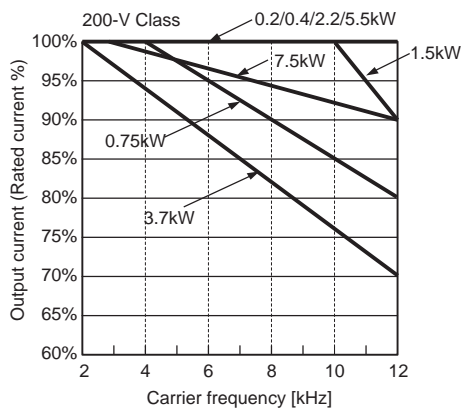

(3) Side-By-Side installation (ambient temperature:40°C)

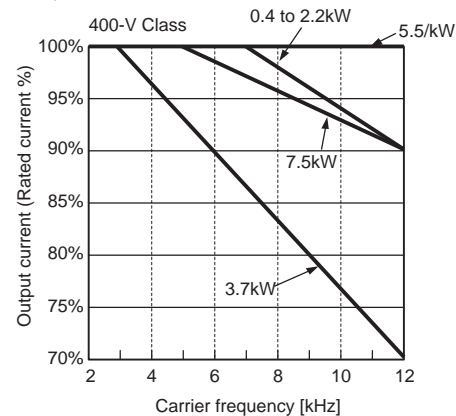
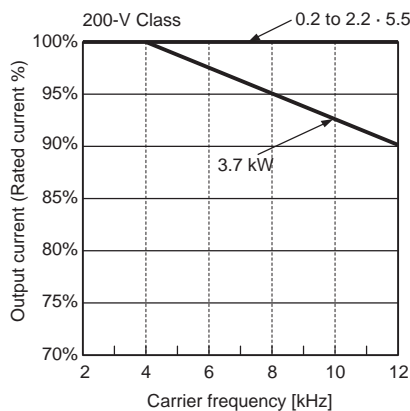

Parameter Initialization

You can initialize the rewritten set values and reset to the factory default, or clear trip records. Note that this is not available for RUN and power ON times.

Parameter No.	Function name	Data	Default setting	Unit
b084	Initialization selection	00: Clears the trip monitor 01: Initializes data 02: Clears the trip monitor and initializes data	00	—
b085	Initialization parameter selection	01: Do not change.	01	—

The multi-function input/output terminals are also initialized with this function. To avoid unexpected operation, be sure to re-examine the wiring.

Refer to page 3-5 for more details about the initialization process.

Frequency Conversion Coefficient

This function displays a conversion value obtained by multiplying the Inverter output frequency by the coefficient set in [b086]. This helps display the actual physical value on the monitor.

Parameter No.	Function name	Data	Default setting	Unit
b086	Frequency conversion coefficient	0.1 to 99.9	1.0	—
Related parameters		d007		

Displayed value [d007] = "Output frequency [d001]" x "Frequency conversion coefficient [b086]"

Refer to page 4-3 for more details

STOP Key Selection

You can select whether to enable the STOP key on the Digital Operator, even if the RUN command is set to the control terminal block (terminal).

Parameter No.	Function name	Data	Default setting	Unit
b087	STOP key selection	00: Enabled 01: Disabled	00	—

•The trip reset function via the STOP/RESET key works according to this setting.

Free-run Stop

This function sets the motor to free running status by shutting off the Inverter output. Also You can select the operation to be performed when the free-run stop input is reset, and select the stop method, deceleration stop or free-run stop.

Parameter No.	Function name	Data	Default setting	Unit
b088	Free-run stop selection	00: 0 Hz start 01: Active Frequency Matching restart	00	—
b091	Stop selection	00: Deceleration → Stop 01: Free-run stop	00	—
b003	Retry wait time	0.3 to 100.	1.0	s
Related parameters		C001 to C005, b003		

Allocate 11 (FRS) to the desired multi-function input.

Data	Symbol	Function name	Status	Description
11	FRS	Free-run stop	ON	Sets the motor to free-run status by shutting off output.
			OFF	The motor is in normal operation.
Related parameters		C001 to C005		

- This function is effective when you stop the motor using the mechanical brake such as an electromagnetic one. Note that an overcurrent trip may occur if the mechanical brake forces the motor to stop during Inverter output.
- Performs a free-run stop (FRS) while the FRS terminal is turned on.
- When the FRS terminal is turned off, the motor restarts after retry wait time b003 elapses. With RUN command selection A002 set to 01 (control terminal), the motor restarts only if the FW terminal is turned on, even in free running.
- You can select the Inverter output mode for restart at free-run stop selection b088 (0 Hz start or Active Frequency Matching restart). (Examples 1, 2)
- The setting of this function is also applied to stop selection b091.

(Example 1) 0 Hz start

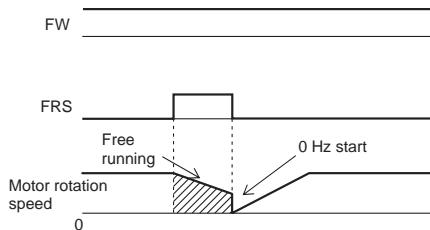

- Starts at 0 Hz regardless of motor rotation speed. The retry wait time is ignored.
- An overcurrent trip may occur with this start at a high motor speed.

(Example 2) Active Frequency Matching restart

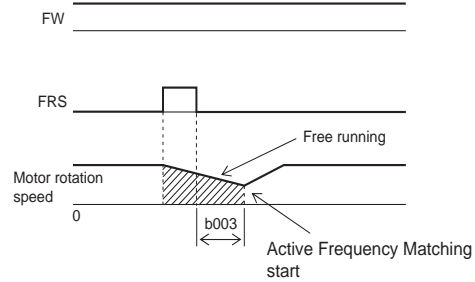

- After the FRS terminal is turned off, the motor frequency is matched and a Active Frequency Matching restart is performed without stopping the motor. If an overcurrent trip occurs, extend the retry wait time.

Main Unit Monitor Display Selection

You can select what items to display on the monitor when the ModBus communication or the Digital Operator is connected with the communications connector on the Inverter.

Parameter No.	Function name	Data	Default setting	Unit
b089	Monitor display selection	01: Output frequency monitor 02: Output current monitor 03: Rotation direction monitor 04: PID feedback value monitor 05: Multi-function input monitor 06: Multi-function output monitor 07: Frequency conversion monitor	01	—

- Enabled when the power is turned on, if:
C070 is set to "02" (Digital Operator), mode selector S7 to "OPE" (Digital Operator), and 3G3AX-OP01 is connected;
C070 is set to "03" (ModBus), mode selector S7 to "485" (RS485 ModBus), and ModBus communication is available.
- With this function enabled, keys other than the STOP/RESET key, and the FREQ adjuster on the Digital Operator are disabled.
- In case of a trip, any trip code from "E01" to "E60" is displayed.
Also refer to "Output Frequency Monitor (After Conversion) [d007]" (page 4-3).

Cooling Fan Control

- Used to operate the built-in cooling fan of the Inverter all the time, only while the Inverter is in operation or when Fin temperature is to high.

This function applies to the Inverter models with a built-in cooling fan.

Parameter No.	Function name	Data	Default setting	Unit
b092	Cooling fan control	00: Always ON 01: ON during RUN 02: Depends on the fin temperature	01	—

- Note that the cooling fan keeps operating for 5 minutes right after the power is turned on and after the operation stops.

Overcurrent Suppression Function

- This function suppresses overcurrent caused by a steep current rise in rapid acceleration.
- Select to enable or disable the overcurrent suppression function in b140.
- This function does not operate during deceleration.

Parameter No.	Function name	Data	Default setting	Unit
b140	Overcurrent suppression function	00: Disabled 01: Enabled	01	—

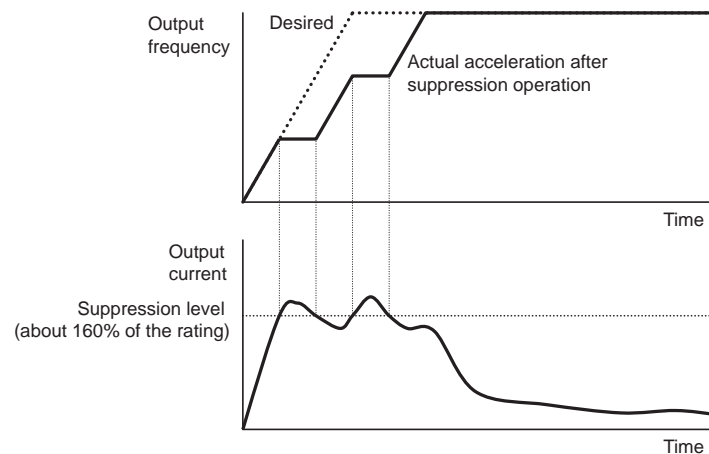

Automatic Carrier Frequency Reduction Function

This function automatically lowers the set carrier frequency when the temperature of the semiconductor inside the Inverter becomes high.

Parameter No.	Function name	Data	Default setting	Unit
b150	Automatic carrier reduction	00: Disabled 01: Enabled	00	—

- While this function is activated, the noise from the motor may be heard differently because of automatic change in carrier frequency.

RDY (Ready) Function

This function prepares for Inverter output to rotate the motor immediately after a RUN command is input. When this function is enabled and the RDY signal is sent to the multi-function input terminal, high voltage is applied to terminals U, V, and W on the main circuit terminal block. This happens even if the motor is stopped with the RUN command turned off. Do not touch the main circuit terminal block.

Parameter No.	Function name	Data	Default setting	Unit
b151	Ready function selection	00: Disabled 01: Enabled	00	—

Allocate 52 (RDY) to the desired multi-function input

Data	Symbol	Function name	Status	Description
52	RDY	Ready function	ON	The Inverter is ready.
			OFF	Normal stop status
Related parameters		C001 to C005		

- Inputting this signal shortens the time between the RUN command input and the start of actual operation. In normal status, this is approx. 20 ms. Shortened time through this function varies depending on timing.

<Group C: Multi-function Terminal Function>

The 3G3JX has five input terminals [1], [2], [3], [4] and [5]; one open collector output terminal [11]; two relay output terminals [AL2] and [AL1] (SPDT contact); and one analog output terminal [AM].

Multi-function Input Selection

The five input terminals [1], [2], [3], [4] and [5] act as multi-function input terminals, whose functions can be changed through reallocation. 31 functions are available for allocation.

You can switch the input logic between Sink and Source, and the contact specifications between NO and NC. (NO [normally open] is allocated by factory default.)

- The terminal with reset allocated is fixed to NO.
- Multi-function input terminal 3 is also used for emergency shutoff input. With DIP switch S8 on the control PCB turned on, emergency shutoff input works. If a signal is input to terminal 3, the output is shut off and an error occurs, not through software but only through hardware. The same two functions cannot be allocated to the multi-function input terminals. If you attempt to allocate the same two functions to the terminals by mistake, the terminal where you allocated the function last takes precedence. The previous data is set to "255", and the terminal function is disabled.
- PTC can be allocated only to input terminal [5].
- Parameter No. C001 to C005 correspond to input terminals [1] to [5] respectively.

This table presents all the multi-function inputs functions available

Data	Description	Reference item	Page
00	FW	Forward command	-
01	RV	Reverse command	-
02	CF1	Multi-step speed setting binary 1	4-12
03	CF2	Multi-step speed setting binary 2	
04	CF3	Multi-step speed setting binary 3	
05	CF4	Multi-step speed setting binary 4	
06	JG	Jogging	4-14
07	DB	External DC injection braking	4-17
08	SET	2nd control selection	4-47
09	2CH	2-step acceleration/deceleration	4-27
11	FRS	Free-run stop	4-41
12	EXT	External trip	4-49
13	USP	Power recovery restart prevention	4-50
15	SFT	Soft lock	4-35
16	AT	analog input switching	4-10
18	RS	Reset	4-50
19	PTC	Thermistor input	4-51
20	STA	3-wire start	4-52

Data	Description	Reference item	Page
21	STP	3-wire stop	4-52
22	F/R	3-wire forward/reverser	
23	PID	PID enabled/disabled	4-22
24	PIDC	PID integral reset	
27	UP	UP/DWN function accelerated	4-53
28	DWN	UP/DWN function decelerated	
29	UDC	UP/DWN function data clear	
31	OPE	Forced operator	4-54
50	ADD	Frequency addition	4-29
51	F-TM	Forced terminal block	4-54
52	RDY	Ready function	4-43
53	SP-SET	Special 2nd function selection	4-47
64	EMR	Emergency shutoff	4-46
255	No function	Digital input not used	-

Parameter No.	Function name	Data	Default setting	Unit	
C001	Multi-function input 1 selection	Refer to upper table for available settings	00	—	
C201	*2nd multi-function input 1 selection				
C002	Multi-function input 2 selection		01	—	
C202	*2nd multi-function input 2 selection				
C003	Multi-function input 3 selection		18	—	
C203	*2nd multi-function input 3 selection				
C004	Multi-function input 4 selection		12	—	
C204	*2nd multi-function input 4 selection				
C005	Multi-function input 5 selection		02	—	
C205	*2nd multi-function input 5 selection				
C011	Multi-function input 1 operation selection		00: NO	00	—
C012	Multi-function input 2 operation selection		01: NC	00	—
C013	Multi-function input 3 operation selection		• NO contact: "ON" with the contact closed, "OFF" with the contact open.	00	—
C014	Multi-function input 4 operation selection		• NC contact: "ON" with the contact open. "OFF" with the contact closed.	00	—
C015	Multi-function input 5 operation selection		• For the RS terminal, only NO contact is available.	00	—

* To switch to the 2nd control, allocate 08 (SET) to the multi-function input terminal and then turn it on.

Note 1: The terminal with "18" (RS) allocated will automatically have an NO contact specifications.

Note 2: "19" (PTC) can only be allocated to multi-function input 5 (C005).

Note 3: "64" (EMR) is set forcibly with switch S8, not with parameters.

Emergency Shutoff Input Function

Emergency Shutoff Mode Selection

To select Emergency Shutoff mode in the 3G3JX, turn on switch S8 on the right side behind the front cover.

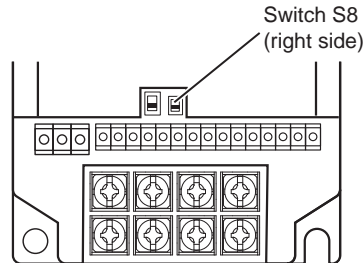

[Notes]

Use caution when turning on/off the DIP switch S8 on the control PCB. That will change the function allocation on the control terminal block automatically.

Note 1: This function does not insulate the motor electrically. Use a breaker such as a contactor in the motor wire if necessary.

Note 2: This function does not prevent erroneous operation of drive process control and the application function.

Note 3: The digital outputs (relay and open collector outputs) of the Inverter are not regarded as the safety signals mentioned here. When you set a safety control circuit as described here, use the output signal of an externally set safety relay.

Wiring Example

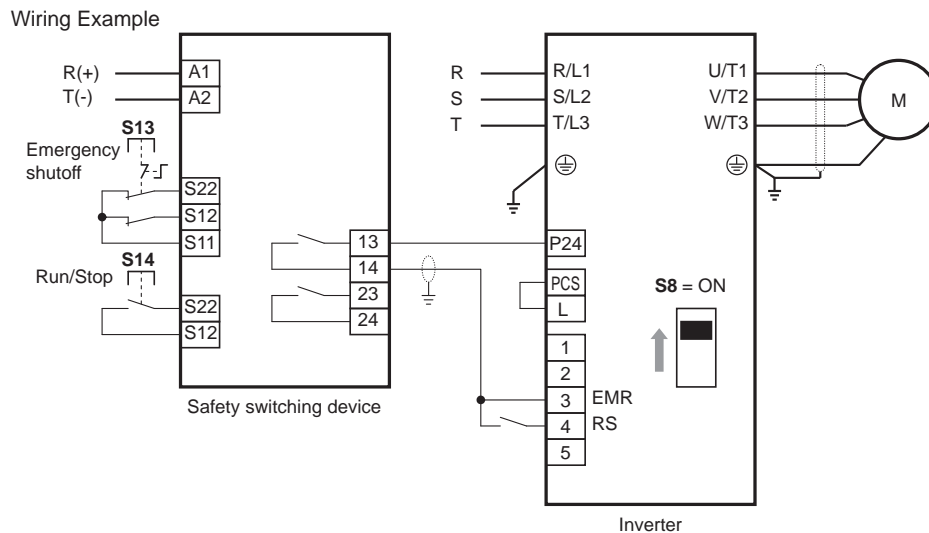

S13: The emergency stop button lets the Inverter go into "Emergency Shutoff" status (or free-run status).

S14: Run/Stop button

- The emergency shutoff circuit is monitored with an externally set safety relay.
- One safety relay can be used for multiple Inverters.

Inputting EMR to the digital input lets the motor go into "Emergency Shutoff" status (or free-run status).

This status continues while EMR is turned on or until a reset signal is input.

To use the Inverter to control the mechanical brake (used for cranes, etc.), you need to connect the safety output of the external safety relay to the brake control circuit in series.

Note 1: For the signal lines for the safety relay and emergency shutoff input, use shielded coaxial cables with 2.8 mm or less in diameter and 2 m or less in length. The shield must be grounded.

Note 2: All inductor parts such as the relay and contactor must have overvoltage protection circuits.

With DIP switch S8 turned on, multi-function input 3 is automatically allocated to the emergency shutoff signal EMR input terminal, and 4 to the reset signal input terminal. In this case, EMR is allocated to function code C003, and reset (RS) to C004 automatically, and you cannot change these parameters manually. The following table shows the status of DIP switch S8 and the allocation of the multi-function input.

Multi-function input terminal No.	Emergency shutoff selector S8		
	S8 = OFF (Default)	S8 = OFF → ON	S8 = ON → OFF
Status	1	2	3
1	FW	FW	FW
2	RV	RV	RV
3	CF1	EMR * (only for emergency shutoff)	No function allocated
4	CF2	RS * (only for emergency shutoff reset)	RS (normal reset)
5 (also used for PTC)	RS	No function allocated	No function allocated

In short, when DIP switch S8 is turned on, input terminal 5 automatically switches to "No function allocated" status. To allocate a function to terminal 5 in this status, use the function mode.

If DIP switch S8 is turned off later, input terminal 3 switches to "No function allocated" status. To allocate a function, again use the function mode.

You can reset Emergency Shutoff status only via the dedicated input terminal (terminal 4 in the above table). The STOP/RESET button on the Digital Operator cannot be used for resetting Emergency Shutoff status.

* When DIP switch S8 is ON, the EMR function is forcibly set to NC contact, and the RS function to NO contact. (Parameters C013 and C014 are ignored)

2nd Control Function and Special 2nd Function

This function is used to operate by switching two different types of motors or additional parameter sets

Data	Symbol	Function name	Status	Description
08	SET	2nd control	ON	Enables the parameter for the 2nd motor.
			OFF	Disables the parameter for the 2nd motor.
53	SP-SET	Special 2nd function	ON	Enables the parameter for the special 2nd motor.
			OFF	Disables the parameter for the special 2nd motor.
Related parameters		C001 to C005		

4-2 Function Mode

- By allocating 08 (SET) or 53 (SP-SET) to the desired multi-function input and then turning on/off the SET or SP-SET terminal, you can switch and control two different motors.
- Switch to the 2nd control function at the SET terminal after turning off the RUN command and the Inverter output.
- You can switch to the 2nd control function at the SP-SET terminal while in operation..

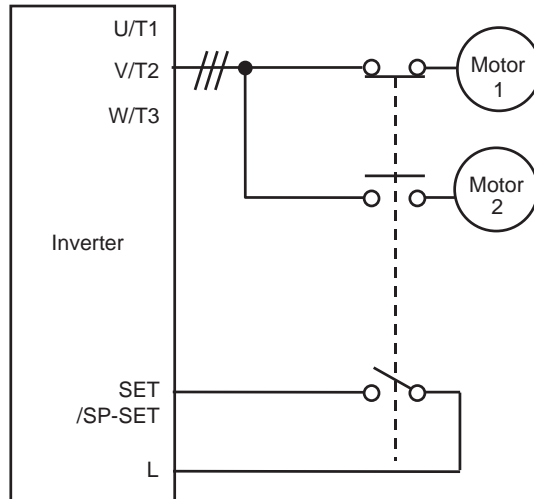

- To display and set each parameter for the 2nd control (parameter No.200s), allocate SET and SP-SET.
- Parameters changeable while in operation are as follows:

Parameter No.	Function name	Selection	
		SET	SP-SET
F002/F202	Acceleration time 1	Yes	Yes
F003/F203	Deceleration time 1	Yes	Yes
A001/A201	Frequency reference selection	No	Yes
A002/A202	RUN command selection	No	Yes
A003/A203	Base frequency	No	Yes
A004/A204	Maximum frequency	No	Yes
A020/A220	Multi-step speed reference 0	Yes	Yes
A041/A241	Torque boost selection	No	Yes
A042/A242	Manual torque boost voltage	Yes	Yes
A043/A243	Manual torque boost frequency	Yes	Yes
A044/A244	V/f characteristics selection	No	Yes
A045/A245	Output voltage gain	No	Yes
A061/A261	Frequency upper limit	Yes	Yes
A062/A262	Frequency lower limit	Yes	Yes
A092/A292	Acceleration time 2	Yes	Yes
A093/A293	Deceleration time 2	Yes	Yes
A094/A294	2-step acceleration/deceleration selection	Yes	Yes
A095/A295	2-step acceleration frequency	Yes	Yes
A096/A296	2-step deceleration frequency	Yes	Yes

Parameter No.	Function name	Selection	
		SET	SP-SET
b012/b212	Electronic thermal level	No	Yes
b013/b213	Electronic thermal characteristics selection	No	Yes
b021/b221	Overload limit selection	No	Yes
b022/b222	Overload limit level	No	Yes
b023/b223	Overload limit parameter	No	Yes
b028/b228	Overload limit source selection	No	Yes
C001 to C005/ C201 to C205	Multi-function inputs 1 to 5 selection	No	Yes
C041/C241	Overload warning level	No	Yes
H003/H203	Motor capacity selection	No	Yes
H004/H204	Motor pole number selection	No	Yes
H006/H206	Stabilization parameter	No	Yes

- There's no indication of 2nd control functions on the display. You'll see which one is enabled by checking whether the terminal is turned on/off.
- Switching the 2nd control using SET during operation does not work until the Inverter stops.

External Trip

Use this function to trip the Inverter according to the peripheral system conditions.

Data	Symbol	Function name	Status	Description
12	EXT	External trip	ON	Sets the motor to free-run status by shutting off output.
			OFF	The motor is in normal operation.
Related parameters		C001 to C005		

- When the EXT terminal is turned on, E12 is displayed and the Inverter trips to stop output.
- Allocate 12 (EXT) to the desired multi-function input.

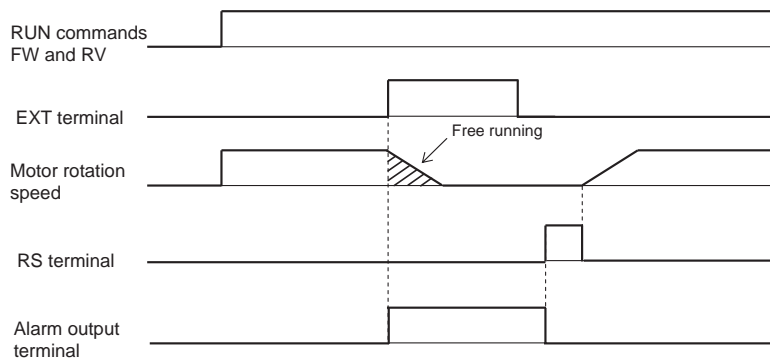

Power Recovery Restart Prevention Function

For safety reasons, this function causes a USP trip (E13) while the RUN command (FW/RV) from the control terminal (terminal) is turned on, in either of the following conditions:

- When the power is turned on
- After an undervoltage trip is reset

Data	Symbol	Function name	Status	Description
13	USP	USP function	ON	Does not start the Inverter with the power turned on while the RUN command is input.
			OFF	Starts the Inverter with the power turned on while the RUN command is input.
Related parameters		C001 to C005		

- You can reset a USP trip by turning off the RUN command (example 1) or resetting the Inverter. The Inverter starts running immediately after a trip reset if the RUN command is still turned on. (Example 2)
- To return from a USP trip to normal operation, shut off the power, turn off the RUN command, turn on the power again, and then turn on the RUN command. (Example 3)
- Allocate 13 (USP) to the desired multi-function input.
- The following shows how this function works.

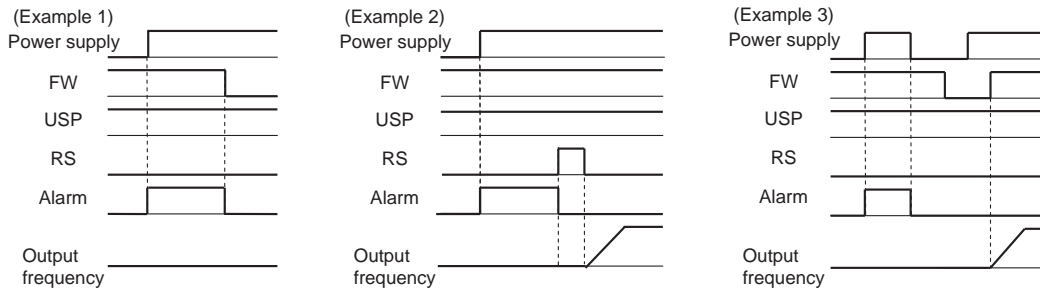

Reset

This function resets an Inverter trip.

Data	Symbol	Function name	Status	Description
18	RS	Reset	ON	Shuts off the power if the Inverter is running. Cleared at trip. (The same process as when the power is turned on)
			OFF	normal operation.
Related parameters		C001 to C005		
Required settings		C102		

- You can also reset an Inverter trip by pressing the STOP/RESET key on the Digital Operator.
- In reset selection C102, you can select alarm reset timing and either enable/disable in normal operation.

•For the RS terminal, only NO contact is available.

Parameter No.	Function name	Data	Default setting	Unit
C102	Reset selection	00: Trip reset at rising edge (example 1) Enabled during normal operation (shuts off output)	00	—
		01: Trip reset at falling edge (example 2) Enabled during normal operation (shuts off output)		
		02: Trip reset at rising edge (example 1) Disabled during normal operation (trip reset only)		

(Example 1)

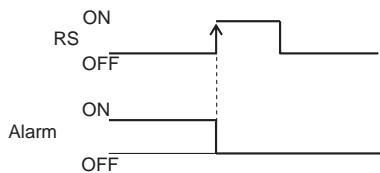

(Example 2)

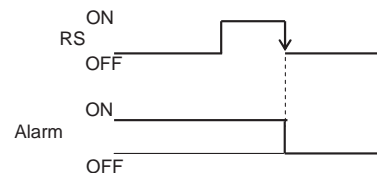

Thermistor Trip Function

This function protects the motor by tripping with the built-in thermistor detecting a temperature rise.

Data	Symbol	Function name	Status	Description
19	PTC	Thermistor input	Connected	When the thermistor is connected between terminals 5 and L, the Inverter can detect motor temperature and, if the temperature exceeds the specified level, trips to shut off the output (E35). The level is fixed.
			Open	If the thermistor is not connected, the Inverter trips (E35) to shut off the output
Related parameters		C005 only		

- Allocate 19 (PTC) to multi-function input 5 (C005). This cannot be used with other multi-function terminals. (Use a thermistor with the PTC characteristics.)
- Trip level is fixed at 3 kΩ ±10% max.

3-wire Input Function

This function is effective in using auto recovery contacts such as a press button switch for operation and stop.

Data	Symbol	Function name	Status	Description
20	STA	3-wire start	ON	Starts with auto recovery contacts.
			OFF	Irrelevant to the motor operation.
21	STP	3-wire stop	ON	Stops with auto recovery contacts.
			OFF	Irrelevant to the motor operation.
22	F/R	3-wire forward/reverse	ON	Reverse
			OFF	Forward
Related parameters		C001 to C005		
Required settings		A002 = 01		

- Set RUN command selection A002 to 01 (control terminal).
- The following operations become possible with 20 (STA), 21 (STP), and 22 (F/R) allocated to the multi-function inputs. With the STA and STP terminals allocated, the FW and RV terminals are disabled.

(1) When using STA, STP, and F/R

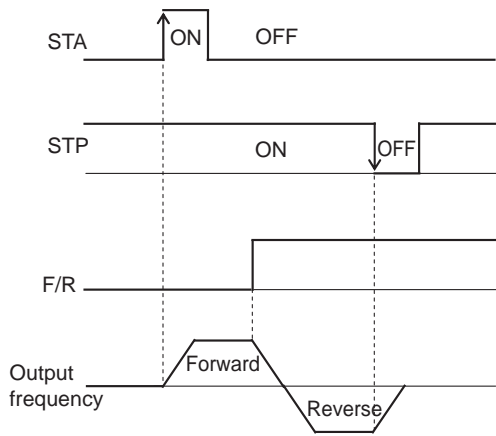

(2) When using STA and STP

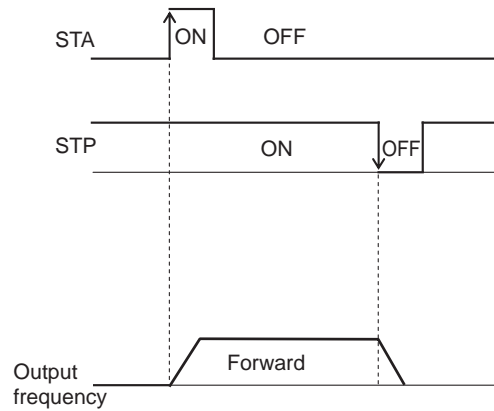

UP/DOWN Function

This function changes the Inverter output frequency using UP and DWN terminals of the multi-function inputs.

Data	Symbol	Function name	Status	Description
27	UP	UP/DWN function accelerated	ON	Increases the current speed during the signal input period.
			OFF	Keeps the current speed.
28	DWN	UP/DWN function decelerated	ON	Decreases the current speed during the signal input period.
			OFF	Keeps the current speed.
29	UDC	UP/DWN function data clear	ON	Clears the stored UP/DWN speed.
			OFF	Keeps the stored UP/DWN speed.
Related parameters		C001 to C005		
Required settings		A001 = 02, C101		

- While the UP/DWN terminal is turned on, the acceleration/deceleration time depends on F002, F003/F202, and F203.
- You can store a frequency set value after UP/DWN adjustment. Choose whether to store the value with C101.

Also, you can clear the stored frequency set value by allocating 29 (UDC) to the desired multi-function input and turning on/off the UDC terminal.

[UP/DOWN Function Enabled/Disabled]

Frequency reference selection (A001)	Multi-step speed	Jogging	Enabled/Disabled
—	—	ON	Disabled
—	ON	OFF	Enabled
00	OFF	OFF	Disabled
01			
02	OFF	OFF	Enabled
03	OFF	OFF	Disabled

- The UP/DOWN function is disabled when the JG operation is enabled.
- The UP/DOWN function is enabled when the frequency reference selection (A001) is set to the Digital Operator (02).
- The UP/DOWN function is enabled when the multi-step speed reference is enabled.

Parameter No.	Function name	Data	Description
C101	UP/DWN selection	00	Does not store the frequency reference adjusted using UP/DWN. After restoring the power, returns the set value to that before UP/DWN.
		01	Stores the frequency reference adjusted using UP/DWN. After restoring the power, maintains the set value after UP/DWN adjustment.

Note: You can store only two codes: multi-step speed reference 0 (A020) and 2nd multi-step speed reference 0 (A220). Even with C101 set to 01, you cannot store the multi-step speeds 1 to 7 adjusted with the UP/DWN function. To store them, press the Enter key as well.

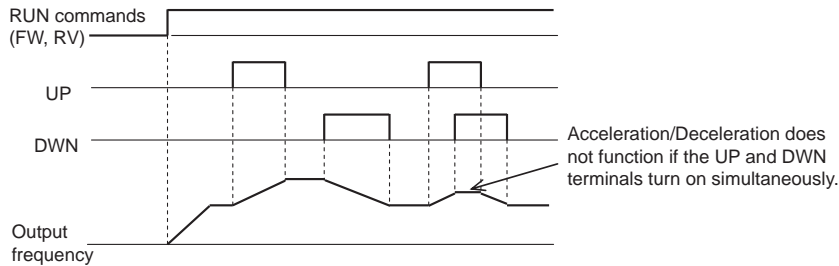

Forced Operator Function

This function forcibly switches to operation via the Digital Operator by turning on/off the multi-function terminal if the frequency reference/RUN command sources are not set to the Digital Operator.

Data	Symbol	Function name	Status	Description
31	OPE	Forced operator	ON	Prioritizes the command from the Digital Operator (A020, A220 set values) over the A001 and A002 settings.
			OFF	Operates according to the A001 and A002 settings.
Related parameters		C001 to C005		
Related codes		A001, A002		

- If you switch on/off this function during operation, the RUN command is reset to stop the Inverter. Before resuming operation, stop the RUN command from each command source to avoid possible danger and then input it again.

Forced Terminal Block Function

This function forcibly switches to operation via the terminal block by turning on/off the multi-function terminal if the frequency reference/RUN command sources are not set to the terminal block.

Data	Symbol	Function name	Status	Description
51	F-TM	Forced terminal block	ON	Forcibly sets A001 = 01 and A002 = 01.
			OFF	Operates according to the A001 and A002 settings.
Related parameters		C001 to C005		
Required settings		A001, A002		

- When the input of this signal is reset, A001 and A002 return to the command status prior to the input.
- If you switch on/off this function during operation, the RUN command is reset to stop the Inverter. Before resuming operation, stop the RUN command from each command source to avoid possible danger and then input it again.

Multi-function Output Terminal Selection

Parameter No.	Function name	Data	Default setting	Unit
C021	Multi-function output terminal 11 selection	00: RUN (signal during RUN) 01: FA1 (constant speed arrival signal) 02: FA2 (over set frequency arrival signal) 03: OL (overload warning) 04: OD (excessive PID deviation) 05: AL (alarm output) 06: Dc (disconnection detection)	00	—
C026	Relay output (AL2, AL1) function selection	07: FBV (PID FB status output) 08: NDc (network error) 09: LOG (logic operation output) 10: ODc (Do not use.) 43: LOC (light load detection signal)	05	—

- You can allocate the following functions to multi-function output terminal 11 and the relay output terminals.
- While the multi-function output terminal 11 selection is for open collector output (allocated in C021), the relay output (AL2, AL1) function selection is for SPDT-contact relay output (allocated in C026).
- You can select NO- or NC-contact output for each output terminal with C031 or C036.

Data	Description	Reference item	Page
00	RUN: Signal during RUN	Signal during RUN	4-55
01	FA1: Constant speed arrival signal	Frequency arrival signal	4-56
02	FA2: Over set frequency arrival signal		
03	OL: Overload warning	Overload warning signal	4-33
04	OD: Excessive PID deviation	Excessive PID deviation output	4-22
05	AL: Alarm output	Alarm output	4-57
06	Dc: Disconnection detection	External analog input disconnection detection	4-58
07	FBV: PID FB status output	PID FB status output	4-22
08	NDc: Network error	Network error	4-58
09	LOG: Logic operation output	Logic operation result output	4-59
10	ODc: Not used.	—	—
43	LOC: Light load detection signal	Light load detection signal	4-60

Signal During RUN

This function outputs a signal while the Inverter is running.

Data	Symbol	Function name	Status	Description
00	RUN	Signal during RUN	ON	The Inverter is in RUN mode.
			OFF	The Inverter is in STOP mode.
Available output terminals		11-CM2, AL2-AL0 (or AL1-AL0)		
Required settings		C021, C026		

•Also outputs a signal during DC injection braking. Below is the time chart.

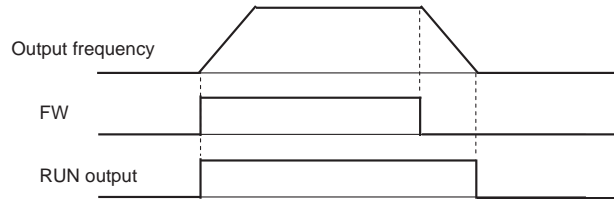

Frequency Arrival Signal

This function outputs a signal when the output frequency has reached the set value.

Data	Symbol	Function name	Status	Description
01	FA1	Constant speed arrival signal	ON	The Inverter output frequency has reached the F001 set value.
			OFF	The Inverter output frequency has fallen below the F001 set value.
02	FA2	Over set frequency arrival signal	ON	The Inverter output frequency has exceeded the C042 set value during acceleration.
			OFF	The Inverter output frequency has fallen below the C042 set value during acceleration.
Available output terminals		11-CM2, AL2-AL0 (or AL1-AL0)		
Required settings		C021, C026, C042, C043		

- For elevating machines, use the FA2 signal for applying the brake.
- Below is the hysteresis of the frequency arrival signal:
 ON: (Set frequency - 1% of the maximum frequency) (Hz)
 OFF: (Set frequency - 2% of the maximum frequency) (Hz)

Parameter No.	Function name	Data	Default setting	Unit
C042	Arrival frequency during acceleration	0.0: Does not output arrival signal during acceleration 0.1 to 400.0: Outputs arrival signal during acceleration	0.0	Hz
C043	Arrival frequency during deceleration	0.0: Does not output arrival signal during deceleration 0.1 to 400.0: Outputs arrival signal during deceleration	0.0	Hz

Constant Speed Arrival Output (01: FA1)

- Outputs a signal when the output frequency has reached the level set in the frequency setting (F001, A020, and A220) or multi-step speed reference (A021 to A035).

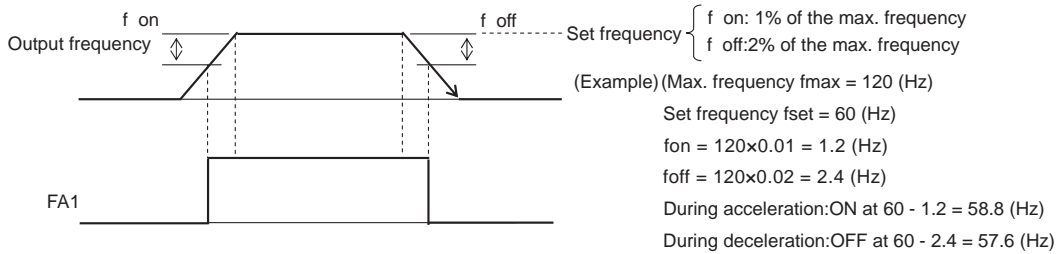

Output Over Set Frequency (02: FA2)

- Outputs a signal when the output frequency has exceeded the arrival frequencies during acceleration/deceleration set in [C042, C043 (FA2)].

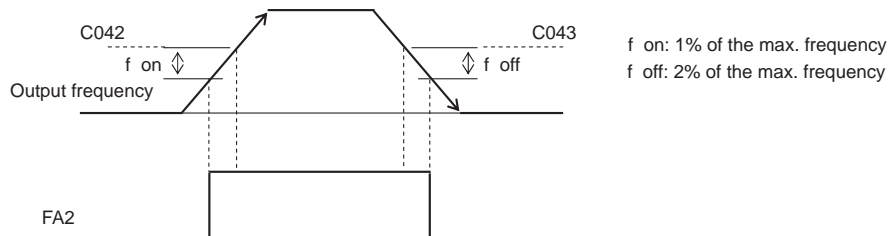

Alarm Output

This is output when the Inverter trips. If you use the relay for alarm outputs, set and check operation,, as the SPDT contact is used for the terminals. For details, refer to the description of the relay output, "Multi-function Output Terminal ON Delay/OFF Delay" (page 4-60).

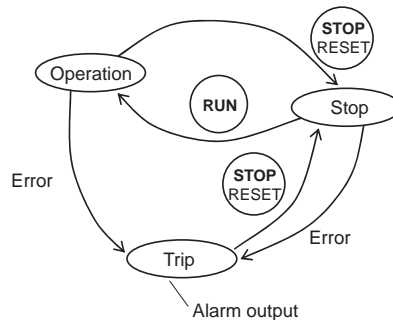

Data	Symbol	Function name	Status	Description
05	AL	Alarm output	ON	The Inverter is in trip status.
			OFF	The Inverter is normal.
Available output terminals		11-CM2, AL2-AL0 (or AL1-AL0)		
Required settings		C021, C026		

External Analog Input Disconnection Detection

•Outputs a signal if an error is detected in the external analog inputs (O, OI).

Data	Symbol	Function name	Status	Description
06	Dc	Disconnection detection	ON	The Inverter is in trip status.
			OFF	The Inverter is normal.
Available output terminals		11-CM2, AL2-AL0 (or AL1-AL0)		
Required settings		C021, C026, A001, A005		

- The disconnection detection signal is output if the frequency reference of the external analog input remains below the starting frequency for 500 ms.
- The signal stops 500 ms after the frequency reference has exceeded the starting frequency.
- Helps detect disconnection when a frequency reference is issued from the external analog inputs (O, OI) with the frequency reference selection set to the terminal (A001 = 01).
- Enabled only when the external analog inputs (O, OI) are selected.

Example 1: Disabled in multi-step speed operation even when the frequency reference is set to the external analog input (A001 = 01).

Example 2: Disabled even when the AT terminal selection is set to the O/volume selection (A005 = 02) or OI/volume selection (A005 = 03) since the frequency reference is set on the Digital Operator (volume) with the AT terminal turned on.

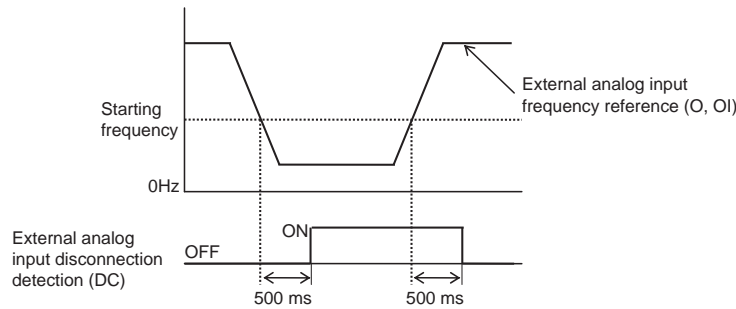

Network Error

This function detects and outputs a network error during RS485 ModBus communication.

- The error is output during RS485 ModBus communication if the next signal does not come even after the specified time period in C077.

Data	Symbol	Function name	Status	Description
08	NDc	Network error	ON	The communication watchdog timer times out.
			OFF	Normal
Available output terminals		11-CM2, AL2-AL0 (or AL1-AL0)		
Required settings		C021, C026, C077		

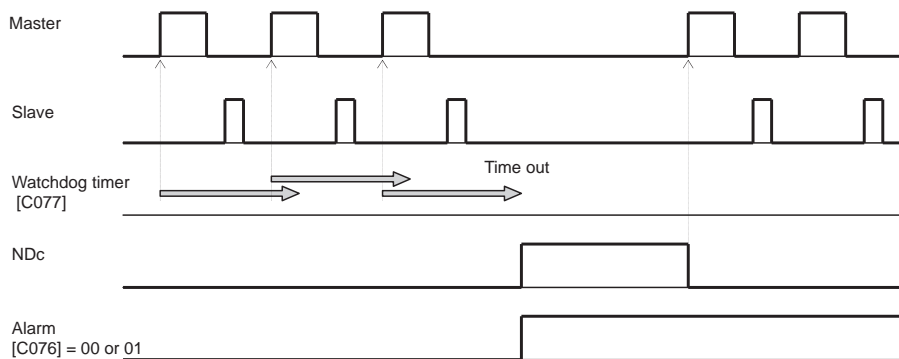

Logic Operation Result Output

This function outputs a logic operation result of combination of two functions.

Data	Symbol	Function name	Status	Description
09	LOG	Logic operation output	ON	See the figure below.
			OFF	
Available output terminals		11-CM2, AL2-AL0 (or AL1-AL0)		
Required settings		C021, C026, C141, C142, C143		

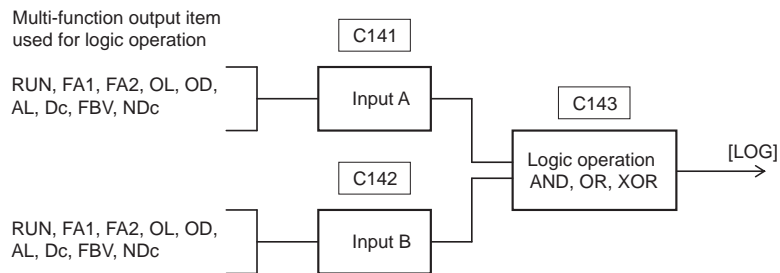

Input signal		[LOG] output		
Input A (C141)	Input B (C142)	AND (C143 = 00)	OR (C143 = 01)	XOR (C143 = 02)
0	0	0	0	0
0	1	0	1	1
1	0	0	1	1
1	1	1	1	0

[Related Function Codes]

Parameter No.	Function name	Data	Default setting	Unit
C141	Logic operation function A input	00: RUN 01: FA1 02: FA2 03: OL 04: OD 05: AL	00	—
C142	Logic operation function B input	06: Dc 07: FBV 08: NDc 10: ODc (Do not use.) 43: LOC	01	—
C143	Logic operator selection	00: AND 01: OR 02: XOR	00	—

Light Load Detection Signal

This function outputs a signal when the Inverter output current has fallen below the C039 set value.

Data	Symbol	Function name	Status	Description
43	LOC	Light load detection signal	ON	Output current is lower than the C039 set value.
			OFF	Output current is higher than the C039 set value.
Available output terminals		11-CM2, AL2-AL0 (or AL1-AL0)		
Required settings		C021, C026, C038, C039		

The signal is output if the load current has fallen below the C039 set value with the light load signal output mode set to 00 or 01 in C038, and LOC (43) allocated to the multi-function output terminal. This function helps avoid a trip resulting from a falling motor current.

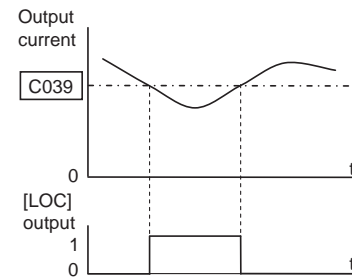

Parameter No.	Function name	Data	Default setting	Unit
C038	Light load signal output mode	00: Enabled during acceleration, constant speed, and deceleration 01: Enabled only during constant speed	01	—
C039	Light load detection level	0.0 to 2.0 × Rated current 0.0: Does not operate	Rated current	A

Multi-function Output Terminal ON Delay/OFF Delay

This function allows you to set ON/OFF delay times respectively from 0.1 to 100 seconds at the signal output of the multi-function output terminals (11 and relay). The following figure shows the output status.

Parameter No.	Function name	Data	Default setting	Unit
C144	Output terminal 11 ON delay	0.0 to 100.0	0.0	s
C145	Output terminal 11 OFF delay	0.0 to 100.0	0.0	s
C148	Relay output ON delay	0.0 to 100.0	0.0	s
C149	Relay output OFF delay	0.0 to 100.0	0.0	s

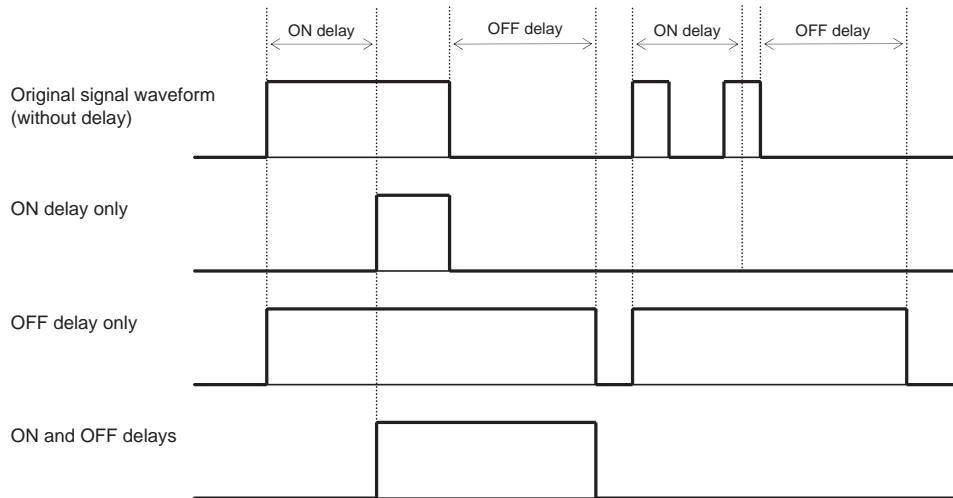

Multi-function Output Terminal Contact Selection

This function allows you to set either contact for the two multi-function output terminals respectively.

Parameter No.	Function name	Data	Default setting	Unit
C031	Multi-function output terminal 11 contact selection	00: NO contact 01: NC contact	00	—
C036	Relay output (AL2, AL1) contact selection	00: NO contact between AL2 and AL0 01: NC contact between AL2 and AL0	01	—

Analog Output AM Terminal

This function allows you to monitor the output frequency and current from the AM terminal on the control terminal block (terminal).

- Analog voltage output from 0 to 10 V.

■AM Selection

- Select a signal to output from the following table.

Parameter No.	Function name	Data	Default setting	Unit
C028	AM selection	00: Output frequency 0 to 10 V (0 to Max. frequency (Hz)) 01: Output current 0 to 10 V (0% to 200% of the rated current)	00	—

Output Frequency

Outputs the voltage according to the output frequency, with the maximum frequency being full scale. This is intended for display indication and cannot be used as a line speed signal. Though the accuracy is $\pm 5\%$, this could be exceeded depending on your meter.

Outputs a frequency obtained by multiplying the output frequency by the conversion coefficient [b086], with the maximum frequency being full scale.

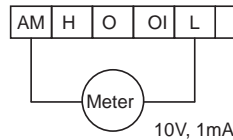

Output Current

Outputs a current value with 200% of the Inverter rated voltage being full scale.

The output method is the same as the output frequency. Monitor accuracy is $\pm 10\%$ at the halfway point of base frequency.

■AM Adjustment

- You can adjust the calibration of the analog voltage (0 to 10 V DC) from the AM terminal on the control terminal block by using the Inverter setting.

Parameter No.	Function name	Data	Default setting	Unit
b080	AM adjustment	0. to 255. (Adjust to the scale)	100.	—
C086	AM offset adjustment	0.0 to 10.0 (See the figure below)	0.0	V
Related parameters		A011, A101, A012, A102, A013, A103, A014, A104, A015, A105		

Note: If the offset (C086) is changed, the point to reach 10 V changes accordingly because of parallel movement. To avoid this, adjust the offset (C086) before the gain (b080).

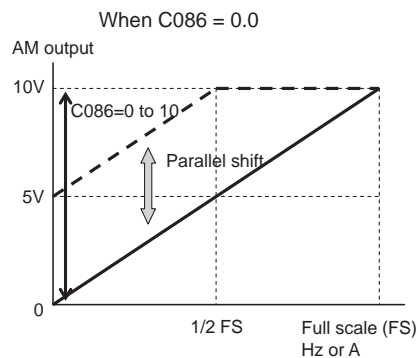
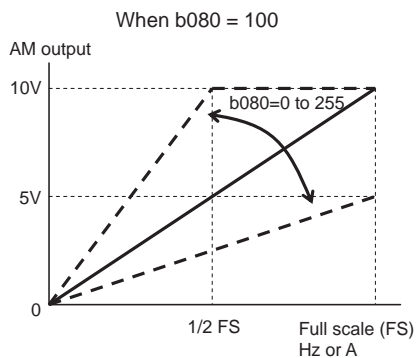

<Group H: Motor Control Parameters>

Motor Capacity and Pole Number

Set the capacity and number of poles of the motor connected to the Inverter.

•With incorrect parameters set, appropriate operation cannot be ensured.

Parameter No.	Function name	Data	Default setting	Unit
H003	Motor capacity selection	200-V class 0.2/0.4/0.75/1.5/2.2/3.7/ 5.5/7.5	Inverter capacity	kW
* H203	2nd motor capacity selection	400-V class 0.4/0.75/1.5/2.2/3.7/5.5/7.5		
H004	Motor pole number selection	2/4/6/8	4	Pole
* H204	2nd motor pole number selection			
Related parameters		A041 to A045, A241 to A244		

* To switch to the 2nd control, allocate 08 (SET) to the multi-function input terminal and then turn it on.

Stabilization Parameter

This function helps to reduce motor hunting.

Parameter No.	Function name	Data	Default setting	Unit
H006	Stabilization parameter	0. to 255.	100	—
* H206	2nd stabilization parameter		100	—
Related parameters		A045, b083		

* To switch to the 2nd control, allocate 08 (SET) to the multi-function input terminal and then turn it on.

- In case of motor hunting, check whether the motor capacity selection (H003/H203) and motor pole number selection (H004/H204) match your motor. If they do not, match them.
- For adjustment, raise the stabilization parameter (H006) by degrees. If this increases motor hunting, lower it by degrees.
- When using the automatic torque boost (A041/A241 = 01), if motor hunting occurs in a low speed range, lower the manual torque boost voltage (A042/A242) and manual torque boost frequency (A043/A243).
- Other than this function, the following methods are suggested to reduce hunting:

Lower the carrier frequency (b083)
Lower the output voltage gain (A045)

Parameter No.	Function name	Data	Description
A045	Output voltage gain	20. to 100.	Unit: % (Lower this in motor hunting.)
b083	Carrier frequency	2.0 to 12.0	Unit: kHz (Lower this in motor hunting.)
H006/H206	Stabilization parameter	0. to 255.	Adjust this in motor hunting.

Communication Function

- Communication with external network control devices can be carried out from the communication connector of the 3G3JX, through the RS-485 complying ModBus-RTU protocol.

■Communication Specifications

Item	Description	Note
Transfer speed	4800/9600/19200 bps	Select using the Digital Operator.
Synch method	Asynchronous method	—
Transfer code	Binary	—
Transmission mode	LSB first	—
Complying interface	RS-485	—
Data bit length	8 bits (ModBus-RTU mode)	(ASCII mode not available)
Parity	No parity/Even/Odd	Select using the Digital Operator.
Stop bit length	1 or 2 bits	Select using the Digital Operator.
Startup method	One-way startup via command from the host side	—
Wait time	Silent interval +0 to 1000[ms]	Set using the Digital Operator.
Connection	1:N (N = Max. 32)	Set using the Digital Operator.
Connector	RJ45 modular jack	—
Error check	Overrun/Framing/CRC-16/Horizontal parity	—

■RS-485 Port Specifications and Connection

Details of each communication connector pin are shown below.

Pin No.:	Symbol	Description
1	—	Not used. Do not connect.
2	—	Not used. Do not connect.
3	—	Not used. Do not connect.
4	—	Not used. Do not connect.
5	SP	Sent and received data: Positive side
6	SN	Sent and received data: Negative side
7	—	Not used. Do not connect.
8	—	Not used. Do not connect.

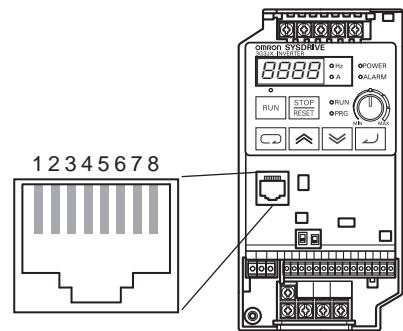

To connect the ModBus, connect each Inverter in parallel as below. Connect a termination resistor separately to avoid signal reflection, since this 3G3JX does not incorporate it. Choose a termination resistor according to the impedance characteristics of the cable to be used.

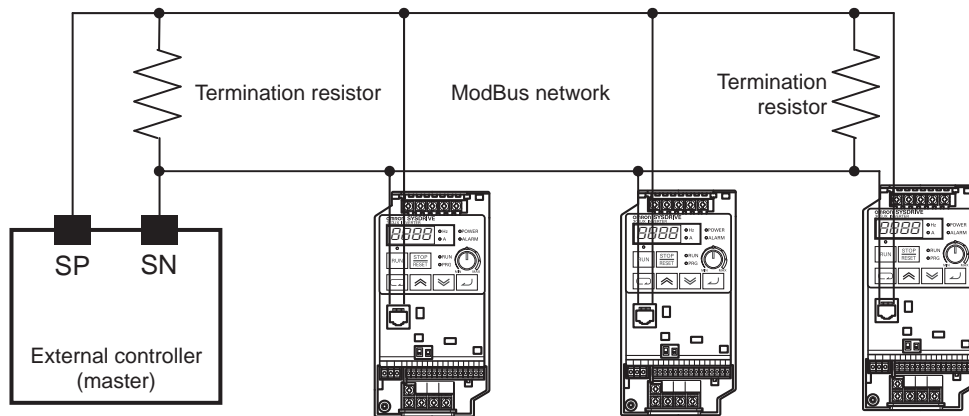

■ ModBus Setting

Switching from the External OPE to ModuBus

1. Set the parameters using the Digital Operator in accordance with your communication environment.
2. Shut off the power.
3. Open the connector cover.
4. Insert the communication cable connected to the ModBus bus line.
5. Set S7 the 485/OPE communications selector to "485".
6. Turn on the power and start ModBus communications.

Switching from ModuBus to the External OPE

1. Remove the ModBus communication line from the RJ45 connector of the Inverter while the Inverter is stopped. Wait 30 seconds to operate the Digital Operator.
2. Set parameter C070 to "02" (OPE) using the Digital Operator and save it.
3. Shut off the power.
4. Set the 485/OPE selector S7 to "OPE" and connect the external OPE to the RJ45 connector.
5. Turn on the power and start external OPE communications.

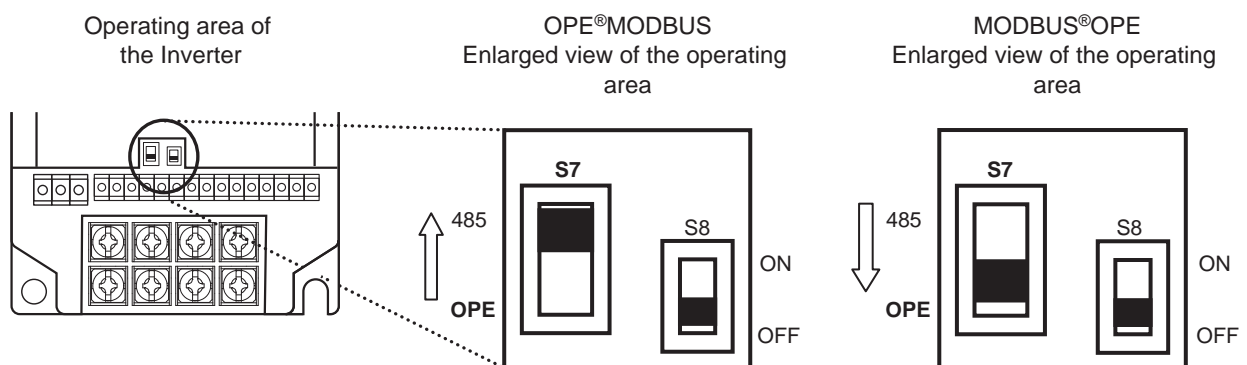

Note: Be sure to set parameter C070 in advance. Communication protocol will not be changed merely by switching S7.

ModBus-Related Parameter Settings

ModBus communication requires the following settings. Be sure to set the parameters shown below. In case the parameter settings are changed, ModBus communication will not start until the Inverter is turned ON again, even if "485" is selected with the 485/OPE selector.

The parameters of C070s cannot be changed or set through ModBus communication. Set with the Digital Operator.

ModBus Communication-Related Parameter List

Parameter No.	Function name	Data	Default setting	Unit
A001	Frequency reference selection	00: Digital Operator (volume) 01: Terminal 02: Digital Operator (F001) 03: ModBus communication 10: Frequency operation result	01	—
A002	RUN command selection	01: Terminal 02: Digital Operator 03: ModBus communication	01	—
b089	Monitor display selection	01: Output frequency monitor 02: Output current monitor 03: Rotation direction monitor 04: PID feedback value monitor 05: Multi-function input monitor 06: Multi-function output monitor 07: Frequency conversion monitor	01	—
C070	Operator/ModBus selection	02: Digital Operator 03: ModBus	02	—
C071	Communication speed selection (Baud rate selection)	04: 4800 bps 05: 9600 bps 06: 19200 bps	06	—
C072	Communication station No. selection	1 to 32	1.	—
C074	Communication parity selection	00: No parity 01: Even 02: Odd	00	—
C075	Communication stop bit selection	1: 1 bit 2: 2 bits	1	—
C076	Communication error selection	00: Trip 01: Trip after deceleration stop 02: Ignore 03: Free run 04: Deceleration stop	02	—
C077	Communication error timeout	0.00 to 99.99	0.00	s
C078	Communication wait time	0 to 1000	0.	ms

ModBus Communication Protocol

Follow the procedures below in regard to communication between the external controller and the Inverter.

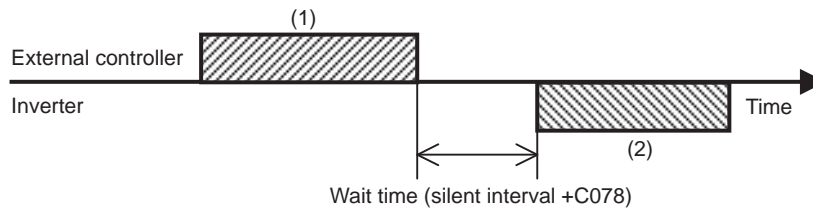

(1): Frame to be sent from the external controller to the Inverter (Query)

(2): Frame to be returned from the Inverter to the external controller (Response)

The Inverter returns a response (Frame (2)) only after receiving a query (Frame (1)) and does not output a response positively.

Each frame format (command) is shown below.

Message configuration: Query

Header (Silent interval)
Slave address
Function code
Data
Error check
Trailer (Silent interval)

<Slave Address>

- Pre-set numbers ranging from 1 to 32 in each Inverter (slave). (Only the Inverter having the same slave address as the query takes in the query.)
- Broadcasting can be performed by setting the slave address to "0".
- Data call or loopback cannot be performed while broadcasting.

<Data>

- Sends the function command.
- The 3G3JX corresponds with the following data formats used in the ModBus.

Data name	Description
Coil	Binary data (1-bit long) that can be referred to or changed
Holding register	16-bit long data that can be referred to or changed

<Function Code>

- Specifies a function for the Inverter to perform.
- The function codes available to the 3G3JX are shown on the next page.

4-2 Function Mode

Function code

Function code	Function	Maximum number of data bytes in 1 message	Maximum data number in 1 message
01h	Coil status reading	4	32 coils (in bits)
03h	Holding register content reading	8	4 registers (in bytes)
05h	Writing into the coil	2	1 coil (in bits)
06h	Writing into holding register	2	1 registers (in bytes)
08h	Loopback test	—	—
0Fh	Writing into multiple coils	4	32 coils (in bits)
10h	Writing into multiple registers	8	4 registers (in bytes)

4

<Error Check>

- CRC (Cyclic Redundancy Check) is used for the ModBus-RTU error check.
- The CRC code is 16-bit data generated for the block of random length data in the 8-bit unit.
- To generate the CRC code, the generation polynomial CRC-16 ($X^{16}+X^{15}+X^2+1$) is used.

CRC-16 Calculation Example

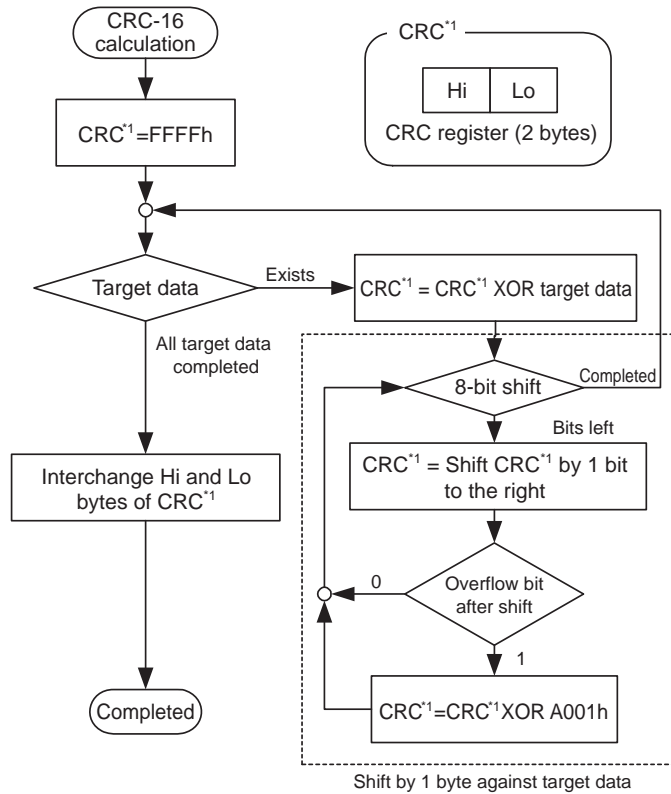

<Header, Trailer (Silent interval)>

- Wait time between receiving the query from the master and the response by the Inverter.
- Be sure to provide the 3.5-character length for wait time. If the length does not reach 3.5 characters, the Inverter does not respond.
- The actual communication wait time is the total of the silent interval (3.5-character length) and C078 (communication wait time) setting.

Message configuration: Response

<Total Communication Time>

- The time between receiving query and the response by the Inverter is the total of the silent interval (3.5-character length) and C078 (communication wait time) setting.
- When sending another query to the Inverter after receiving the response from the Inverter, be sure to provide the silent interval length (3.5-character length or more) at the minimum.

<Normal Response>

- If the query is the loopback function code (08h), the Inverter sends back a response of the same content as the query.
- If the query contains a function code of writing into the holding register or coil (05h, 06h, 0Fh, 10h), the Inverter sends back the query as it is in response.
- If the query contains a function code of reading the holding register or coil (01h, 03h), the Inverter makes the slave address and function code the same as the query and attaches the read data to the query.

<Abnormal Response>

Field Configuration

Slave address
Function code
Exception code
CRC-16

- If an error (aside from a communication error) is found in the query content, the Inverter returns an exception response without performing any operation.
- To determine the cause of an error, check the function code of the response. The function code of the exception response is the value of the query function code with 80h added.
- Check the details of the error with the exception code.

Exception code

Code	Description
01h	Specified an unsupported function.
02h	Specified address does not exist.
03h	Specified data has an unacceptable format.
21h	Data is out of the Inverter's range for writing into the holding register.
22h	The Inverter does not allow this function. <ul style="list-style-type: none"> •Attempted to change the register that cannot be changed during operation. •Has issued the enter command during operation (UV). •Has written into the register during trip (UV). •Has written into the register used exclusively for reading.
23h	Has written into the register (coil) used exclusively for reading.

<No Response>

The Inverter ignores a query and does not respond when:

- The broadcast is received.
- A communication error is detected in receiving a query.
- The query slave address does not correspond with the slave address set for the Inverter.
- The time interval between 2 pieces of data constituting the message is less than a 3.5-character length.
- Query data length is inappropriate.
- The reception interval in a frame exceeds the 1.5-character length.

Note: Provide a timer in the master to monitor the response, and if no response is returned within the set time period, send the same query again.

■ Explanation of Each Function Code

<Coil status reading [01h]>

Reads out the coil status (ON/OFF).

(Example)

When reading multi-function input terminals from 1 to 5 of the Inverter with the slave address "8" Refer to the following table for multi-function input terminal statuses. (Coils from 12 to 14 are OFF.)

Class	Data				
Multi-function input terminals	1	2	3	4	5
Coil No.	7	8	9	10	11
Terminal status	ON	OFF	ON	OFF	OFF

No.	Field name	Example (HEX)
1	Slave address *1	08
2	Function code	01
3	Coil start number (MSB)	00
4	Coil start number (LSB)	06
5	Number of coils (MSB)*2	00
6	Number of coils (LSB)*2	05
7	CRC-16 (MSB)	1C
8	CRC-16 (LSB)	91

No.	Field name	Example (HEX)
1	Slave address	08
2	Function code	01
3	Number of data bytes	01
4	Coil data *3	05
5	CRC-16 (MSB)	92
6	CRC-16 (LSB)	17

*1. Broadcasting cannot be performed.

*2. When specifying the value for 0 or over 31 of the reading coils, the error code "03h" is sent.

*3. Data is transferred by the number of data bytes.

The data received as the response shows the statuses of coils 7 to 14. The data received here, "05h = 00000101b", should be read with setting coil 7 as LSB as follows:

Item	Data							
Coil No.	14	13	12	11	10	9	8	7
Coil status	OFF	OFF	OFF	OFF	OFF	ON	OFF	ON

If the reading coil exceeds the defined coil range in the final coil data, such coil data is regarded as "0" and returned.

Refer to "<Exception Response>" (4-75) if the coil status reading command has not been performed normally.

<Reading the Holding Register Content [03h]>

Reads the specified number of consecutive holding register contents from the specified holding register addresses.

(Example)

- Reads the latest trip information (frequency, current, voltage at trip) from the Inverter with the slave address "1".
- Refer to the trip status as follows:

3G3JX command	D081 (Factor)	D081 (Frequency)	D081 (Output current)	D081 (DC bus V DC)
Register No.	0012h	0014h	0016h	0017h
Trip status	Overcurrent (E03)	9.9 Hz	3.0 A	284 V

Query		
No.	Field name	Example (Hex)
1	Slave address*1	01
2	Function code	03
3	Register start address *3(MSB)	00
4	Register start address *3(LSB)	11
5	Number of holding registers (MSB)	00
6	Number of holding registers (LSB)	06
7	CRC-16 (MSB)	95
8	CRC-16 (LSB)	CD

Response		
No.	Field name	Example (Hex)
1	Slave address	01
2	Function code	03
3	Number of data bytes*2	0C
4	Register data 1 (MSB)	00
5	Register data 1 (LSB)	03
6	Register data 2 (MSB)	00
7	Register data 2 (LSB)	00
8	Register data 3 (MSB)	00
9	Register data 3 (LSB)	63
10	Register data 4 (MSB)	00
11	Register data 4 (LSB)	00
12	Register data 5 (MSB)	00
13	Register data 5 (LSB)	1E
14	Register data 6 (MSB)	01
15	Register data 6 (LSB)	1C
16	CRC-16 (MSB)	AF
17	CRC-16 (LSB)	6D

*1. Broadcasting cannot be performed.

*2. Data is transferred by the number of data bytes. In this example, 12 ("0Ch") bytes are used since 6 pieces of holding register data are returned.

*3. Note that the holding register start address is "0011h", which is smaller by 1 than the register number "0012h".

4-2 Function Mode

Read the data received in the response, as follows:

Response buffer	4-5		6-7		8-9	
Holding register start number	12+0 (MSB)	12+0 (LSB)	12+1 (MSB)	12+1 (LSB)	12+2 (MSB)	12+2 (LSB)
Response data	0003h		00h	00h	0063h	
Trip data	Trip factor (03)		Not used		Frequency (9.9 Hz)	
Response buffer	10-11		12-13		14-15	
Holding register start number	12+3 (MSB)	12+3 (LSB)	12+4 (MSB)	12+4 (LSB)	12+5 (MSB)	12+5 (LSB)
Response data	00h	00h	001Eh		001Ch	
Trip data	Not used		Output current (3.0 A)		DC bus V DC (284V)	

Refer to "<Exception Response>" (4-75) if the holding register content reading command has not been performed normally.

<Writing Into the Coil [05h]>

Writes into one coil.

The coil status change is shown in the following table.

Data	Coil status	
	OFF → ON	ON → OFF
Change data (MSB)	FFh	00h
Change data (LSB)	00h	00h

(Example)

- Issues the RUN command to the Inverter with the slave address "8". For running, "03" must be set to "A002".
- The coil number of the RUN command is "1".

Query			Response		
No.	Field name	Example (Hex)	No.	Field name	Example (Hex)
1	Slave address ^{*1}	08	1	Slave address	08
2	Function code	05	2	Function code	05
3	Coil address ^{*2} (MSB)	00	3	Coil address ^{*2} (MSB)	00
4	Coil address ^{*2} (LSB)	00	4	Coil address ^{*2} (LSB)	00
5	Change data (MSB)	FF	5	Change data (MSB)	FF
6	Change data (LSB)	00	6	Change data (LSB)	00
7	CRC-16 (MSB)	8C	7	CRC-16 (MSB)	8C
8	CRC-16 (LSB)	A3	8	CRC-16 (LSB)	A3

*1. There is no response for broadcasting.

*2. Note that the coil start address is "0", which is smaller by 1 than the coil number "1". The coil addresses for coil numbers from "1 to 31" are "0 to 30".

Refer to "<Exception Response>" (4-75) if writing into the coil cannot be performed normally.

<Writing into the holding register [06h]>

Writes data into the specified holding register.

(Example)

Write "50 Hz" into the Inverter with slave address "8" as multi-step speed reference 0 (A020).

The data resolution of the holding register "1029h" of multi-step speed reference 0 (A020) is 0.1 Hz.

To set 50 Hz, set the change data to "500 (01F4h)".

Query			Response		
No.	Field name	Example (Hex)	No.	Field name	Example (Hex)
1	Slave address ^{*1}	08	1	Slave address	08
2	Function code	06	2	Function code	06
3	Register address ^{*2} (MSB)	10	3	Register address ^{*2} (MSB)	10
4	Register address ^{*2} (LSB)	28	4	Register address ^{*2} (LSB)	28
5	Change data (MSB)	01	5	Change data (MSB)	01
6	Change data (LSB)	F4	6	Change data (LSB)	F4
7	CRC-16 (MSB)	0D	7	CRC-16 (MSB)	0D
8	CRC-16 (LSB)	8C	8	CRC-16 (LSB)	8C

*1. There is no response for broadcasting.

*2. Note that the holding register start address is "1028h", which is smaller by 1 than the register number "1029h".

Refer to "<Exception Response>" (4-75) if writing into the holding register cannot be performed normally.

<Loopback Test [08h]>

Used to check the communications between master and slave. A random value can be used for test data.

(Example)

Loopback test to the Inverter with the slave address "1"

Query			Response		
No.	Field name	Example (HEX)	No.	Field name	Example (HEX)
1	Slave address *	01	1	Slave address	01
2	Function code	08	2	Function code	08
3	Test sub code (MSB)	00	3	Test sub code (MSB)	00
4	Test sub code (LSB)	00	4	Test sub code (LSB)	00
5	Data (MSB)	Random	5	Data	Random
6	Data (LSB)	Random	6	Data	Random
7	CRC-16 (MSB)	CRC	7	CRC-16 (MSB)	CRC
8	CRC-16 (LSB)	CRC	8	CRC-16 (LSB)	CRC

* Broadcasting cannot be performed.

The test sub code corresponds only with the query data echo (00h, 00h), not any other command.

<Writing Into Multiple Coils [0Fh]>

Rewrites consecutive multiple coils.

(Example)

Change the status of multi-function input terminals [1] to [5] of the Inverter with the slave address "8".

Refer to the following table for the status of multi-function input terminals [1] to [5].

Multi-function input terminals	[1]	[2]	[3]	[4]	[5]
Coil No.	7	8	9	10	11
Terminal status	ON	ON	ON	OFF	ON

Query			Response		
No.	Field name	Example (HEX)	No.	Field name	Example (HEX)
1	Slave address *1	08	1	Slave address	08
2	Function code	0F	2	Function code	0F
3	Coil start address (MSB) *3	00	3	Coil start address (MSB) *3	00
4	Coil start address (LSB) *3	06	4	Coil start address (LSB) *3	06
5	Number of coils (MSB)	00	5	Number of coils (MSB)	00
6	Number of coils (LSB)	05	6	Number of coils (LSB)	05
7	Number of bytes *2	02	7	CRC-16 (MSB)	75
8	Change data (MSB)	17	8	CRC-16 (LSB)	50
9	Change data (LSB)	00			
10	CRC-16 (MSB)	83			
11	CRC-16 (LSB)	EA			

*1. There is no response for broadcasting.

*2. Since the change data comprises both MSB and LSB as a set, make the byte to be an even number by adding 1, even if the byte which actually needs to be changed is an odd number.

*3. Note that the coil start address is "6", which is smaller by 1 than the coil number "7". The coil addresses for coil numbers from "1 to 31" are "0 to 30".

Refer to "<Exception Response>" (4-75) if writing into multiple coils cannot be performed normally.

<Writing into multiple holding registers [10h]>

Writes into consecutive multiple holding registers.

(Example)

Set "3000 seconds" to acceleration time 1 (F002) for the Inverter with the slave address "8".

The data resolution of the holding register "1024h, 1015h" of acceleration time 1 (F002) is 0.01 seconds. To set 3000 seconds, set change data to "300000 (000493E0h)".

Query			Response		
No.	Field name	Example (HEX)	No.	Field name	Example (HEX)
1	Slave address *1	08	1	Slave address	08
2	Function code	10	2	Function code	10
3	Start address (MSB)*3	10	3	Start address (MSB)	10
4	Start address (LSB)*3	13	4	Start address (LSB)	13
5	Number of holding registers (MSB)	00	5	Number of holding registers (MSB)	00
6	Number of holding registers (LSB)	02	6	Number of holding registers (LSB)	02
7	Number of bytes *2	04	7	CRC-16 (MSB)	B4
8	Change data 1 (MSB)	00	8	CRC-16 (LSB)	54
9	Change data 1 (LSB)	04			
10	Change data 2 (MSB)	93			
11	Change data 2 (LSB)	E0			
12	CRC-16 (MSB)	7D			
13	CRC-16 (LSB)	53			

*1. There is no response for broadcasting.

*2. Specify the number of bytes to be changed, not the number of holding registers.

*3. Note that the holding register start address is "1013h", which is smaller by 1 than the register number "1014h".

Refer to "<Exception Response>" below if writing into the multiple holding registers cannot be performed normally.

<Exception Response>

The master requires a response for a query except for broadcasting. Though the Inverter should return a response corresponding with the query, it returns an exception response if the query has an error.

The exception response has a field configuration shown in the following table.

Field Configuration
Slave address
Function code
Exception code
CRC-16

The detailed field configuration is shown on the next page. The function code of the exception response is the value of the query function code with 80h added. The exception code shows the cause of exception response.

Function code	
Query	Exception response
01h	81h
03h	83h
05h	85h
06h	86h
0Fh	8Fh
10h	90h

Exception code	
Code	Description
01h	Specified an unsupported function.
02h	Specified address does not exist.
03h	Specified data has an unacceptable format.
21h	Data is out of the Inverter's range for writing into the holding register.
22h	The Inverter does not allow this function. <ul style="list-style-type: none"> • Attempted to change the register which cannot be changed during operation. • Has issued the enter command during operation (UV). • Has written into the register during trip (UV). • Has written into the register used exclusively for reading.
23h	Has written into the register (coil) used exclusively for reading.

■ To Save the Change to the Holding Register (enter command)

Even if using the command to write into the holding register (06h) or into the consecutive holding registers (10h), no change can be saved in the EEPROM memory element of the Inverter. If the Inverter power shuts off without saving any changes, the holding register returns to the status before the changes were made. To save the holding register changes in the Inverter's EEPROM memory element, the "enter command" must be issued according to the following procedure.

To issue the enter command

Write into all memory write (holding register number 0900h) using the writing command into the holding register (06h). In this case, a random value can be written into the holding register (0900h).

Notes:

- The enter command needs considerable time. Monitor the data writing signal (coil number 001Ah) to check whether the data is being written.
- Since the Inverter's EEPROM memory element has a limit on the number of rewrites (approx. 100,000 times), the Inverter life may be shortened if enter commands are frequently used.

■ Register Number List

R/W in the list shows whether the coil or holding register accepts reading and/or writing.

R: Read only R/W: Read and write enabled

Coil Number List

Coil No.	Item	R/W	Description
0000h	Not used	—	
0001h	RUN commands	R/W	1: RUN 0: Stop (Enabled when A002 = 03)
0002h	Rotation direction command	R/W	1: Reverse 0: Forward (Enabled when A002 = 03)
0003h	External Trip (EXT)	R/W	1: Trip
0004h	Trip reset (RS)	R/W	1: Reset
0005h	Not used	—	
0006h	Not used	—	
0007h	Multi-function input 1	R/W	1: ON 0: OFF *1
0008h	Multi-function input 2	R/W	1: ON 0: OFF *1
0009h	Multi-function input 3	R/W	1: ON 0: OFF *1
000Ah	Multi-function input 4	R/W	1: ON 0: OFF *1
000Bh	Multi-function input 5	R/W	1: ON 0: OFF *1
000Dh	Not used		
000Eh	Operation status	R	1: RUN 0: Stop (Interlocked with d003)
000Fh	Rotation direction	R	1: Reverse 0: Forward (Interlocked with d003)
0010h	Inverter ready	R	1: Ready 0: Not ready
0011h	Not used	—	
0012h	Not used	—	
0013h	Not used	—	
0014h	Alarm signal	R	1: During trip 0: Normal
0015h	Excessive PID deviation signal	R	1: ON
0016h	Overload warning signal	R	0: OFF

*1. When either the control circuit terminal block or the coil is turned ON, these settings are ON.

The control circuit terminal block has the priority for the multi-function input.

If the master cannot reset the coil ON status due to communication disconnection, turn the control circuit terminal block from ON to OFF in order to turn OFF the coil

*2. The content of a communications error is retained until a fault reset is input. (Available to reset during operation)

4-2 Function Mode

Coil No.	Item	R/W	Description
0017h	Frequency arrival signal (Over set frequency)	R	1: ON 0: OFF
0018h	Frequency arrival signal (At a constant speed)	R	
0019h	Signal during RUN	R	
001Ah	Data writing	R	1: Writing 0: Normal
001Bh	CRC error	R	1: Error 0: No error *2
001Ch	Overflow error	R	
001Dh	Framing error	R	
001Eh	Parity error	R	
001Fh	Check sum error	R	

*1. When either the control circuit terminal block or the coil is turned ON, these settings are ON.

The control circuit terminal block has the priority for the multi-function input.

If the master cannot reset the coil ON status due to communication disconnection, turn the control circuit terminal block from ON to OFF in order to turn OFF the coil

*2. The content of a communications error is retained until a fault reset is input. (Available to reset during operation)

Holding Register Number List

Register No.	Function name	Parameter No.	R/W Function	Monitor or data range	Resolution
0002h	Frequency reference (Enable when A001 = 03)	—	R/W	0 to 4000	0.1 [Hz]
0003h	Inverter status	—	R	00: Default 01: (Reserved) 02: Stop 03: Run 04: Free-run stop (FRS) 05: Jogging 06: DC injection braking 07: Retry 08: Trip 09: Undervoltage	—
0005h	PID feedback (Enable when A076 = 02)	—	R/W	0 to 1000	0.1 [%]
1002h	Output frequency monitor	d001	R	0 to 4000	0.1 [Hz]
1003h	Output current monitor	d002	R	0 to 2000	0.1 [%]
1004h	Rotation direction monitor	d003	R	00: Stop 01: Forward 02: Reverse	
1005h	PID feedback value monitor (A075 PID scale)	d004 (MSB)	R	0 to 999900	0.01 [%]
1006h		d004 (LSB)			
1007h	Multi-function input monitor	d005	R	0 to 63 Multi-function input status, Bit 0 = [1] to Bit 4 = [5]	—

Register No.	Function name	Parameter No.	R/W Function	Monitor or data range	Resolution		
1008h	Multi-function output monitor	d006	R	0 to 7 Multi-function output status, Bit 0 = [11] Bit 1 = Not used. Bit 2 = [AL2]	—		
1009h	Output frequency monitor (after conversion)	d007 (MSB)	R	0 to 3996000	0.01		
100Ah		d007 (LSB)					
100Ch	Output voltage monitor	d013	R	0 to 20000	0.01 [%]		
100Eh	Total RUN time	d016 (MSB)	R	0 to 999999	1 [h]		
100Fh		d016 (LSB)					
1010h	Power ON time monitor	d017 (MSB)	R	0 to 999999	1 [h]		
1011h		d017 (LSB)					
116Ah	Fin temperature monitor	d018	R	0 to 2000	0.1 [°C]		
0011h	Fault frequency monitor	d080	R	0 to 65535	—		
0012h	Fault monitor 1	d081	R	Trip monitor 1: Factor code	—		
0014h			R	Trip monitor 1: Frequency	0.1 [Hz]		
0016h			R	Trip monitor 1: Current	0.1 [A]		
0017h			R	Trip monitor 1: Voltage	1. [V]		
0018h			R	Trip monitor 1: Run time (MSB)	1. [h]		
0019h			R	Trip monitor 1: Run time (LSB)			
001Ah			R	Trip monitor 1: ON time (MSB)	1. [h]		
001Bh			R	Trip monitor 1: ON time (LSB)			
001Ch			Fault monitor 2	d082	R	Trip monitor 2: Factor code	—
001Eh					R	Trip monitor 2: Frequency	0.1 [Hz]
0020h	R	Trip monitor 2: Current			0.1 [A]		
0021h	R	Trip monitor 2: Voltage			1. [V]		
0022h	R	Trip monitor 2: Run time (MSB)			1. [h]		
0023h	R	Trip monitor 2: Run time (LSB)					
0024h	R	Trip monitor 2: ON time (MSB)			1. [h]		
0025h	R	Trip monitor 2: ON time (LSB)					
0026h	Fault monitor 3	d083	R	Trip monitor 3: Factor code	—		
0028h				Trip monitor 3: Frequency	0.1 [Hz]		
002Ah				Trip monitor 3: Current	0.1 [A]		
002Bh				Trip monitor 3: Voltage	1. [V]		
002Ch	Fault monitor 3	d083	R	Trip monitor 3: Run time (MSB)	1. [h]		
002Dh				Trip monitor 3: Run time (LSB)			
002Eh				Trip monitor 3: ON time (MSB)	1. [h]		
002Fh				Trip monitor 3: ON time (LSB)			
116Ch	DC voltage monitor	d102	R	0 to 9999	0.1 [V]		
116Dh	Electronic thermal monitor	d104	R	0 to 1000	0.1 [%]		
1014h	Acceleration time 1	F002 (MSB)	R/W	1 to 300000 The second decimal place is ignored when the value is over 10000 (100.0 seconds).	0.01 [s]		
1015h		F002 (LSB)	R/W				

4-2 Function Mode

Register No.	Function name	Parameter No.	R/W Function	Monitor or data range	Resolution
1501h	2nd acceleration time 1	F202 (MSB)	R/W	1 to 300000 The second decimal place is ignored when the value is over 10000 (100.0 seconds).	0.01 [s]
1502h		F202 (LSB)	R/W		
1016h	Deceleration time 1	F003 (MSB)	R/W	1 to 300000 The second decimal place is ignored when the value is over 10000 (100.0 seconds).	0.01 [s]
1017h		F003 (LSB)	R/W		
1503h	2nd deceleration time 1	F203 (MSB)	R/W	1 to 300000 The second decimal place is ignored when the value is over 10000 (100.0 seconds).	0.01 [s]
1504h		F203 (LSB)	R/W		
1018h	Operator rotation direction selection	F004	R/W	0: Forward 1: Reverse	—
1019h	Frequency reference selection	A001	R/W	00: Digital Operator (volume) 01: Terminal 02: Digital Operator (F001) 03: ModBus communication 10: Frequency operation result	—
101Ah	RUN command selection	A002	R/W	01: Terminal 02: Digital Operator 03: ModBus communication	
101Bh	Base frequency	A003	R/W	30. to maximum frequency A004	1. [Hz]
150Ch	2nd base frequency	A203	R/W	30. to maximum frequency A204	1. [Hz]
101Ch	Maximum frequency	A004	R/W	30 to 400	1. [Hz]
150Dh	2nd maximum frequency	A204	R/W	30 to 400	1. [Hz]
101Dh	O/OI selection	A005	R/W	02: Switches between O/VR via terminal AT 03: Switches between OI/VR via terminal AT 04: Terminal O 05: Terminal OI	—
1020h	O start frequency	A011	R/W	0 to 4000	0.1 [Hz]
1022h	O end frequency	A012	R/W	0 to 4000	0.1 [Hz]
1023h	O start ratio	A013	R/W	0 to 100	1 [%]
1024h	O end ratio	A014	R/W	0 to 100	1 [%]
1025h	O start selection	A015	R/W	00: Start frequency A011 01: 0 Hz	—
1026h	O, OI sampling	A016	R/W	1 to 17	—
1029h	Multi-step speed reference 0	A020	R/W	0.0/Starting frequency to 4000	0.1 [Hz]
150Fh	2nd multi-step speed reference 0	A220	R/W	0.0/Starting frequency to 4000	0.1 [Hz]
102Bh	Multi-step speed reference 1	A021	R/W	0.0/Starting frequency to 4000	0.1 [Hz]
102Dh	Multi-step speed reference 2	A022	R/W		
102Fh	Multi-step speed reference 3	A023	R/W		
1031h	Multi-step speed reference 4	A024	R/W		
1033h	Multi-step speed reference 5	A025	R/W		
1035h	Multi-step speed reference 6	A026	R/W		
1037h	Multi-step speed reference 7	A027	R/W		
1039h	Multi-step speed reference 8	A028	R/W		
103Bh	Multi-step speed reference 9	A029	R/W		

Register No.	Function name	Parameter No.	R/W Function	Monitor or data range	Resolution
103Dh	Multi-step speed reference 10	A030	R/W	0.0/Starting frequency to 4000	0.1 [Hz]
103Fh	Multi-step speed reference 11	A031	R/W		
1041h	Multi-step speed reference 12	A032	R/W		
1043h	Multi-step speed reference 13	A033	R/W		
1045h	Multi-step speed reference 14	A034	R/W		
1047h	Multi-step speed reference 15	A035	R/W		
1048h	Jogging frequency	A038	R/W	0 to 999	0.01 [Hz]
1049h	Jogging stop selection	A039	R/W	00: Free-run stop 01: Deceleration stop 02: DC injection braking stop	—
104Ah	Torque boost selection	A041	R/W	00: Manual torque boost only 01: Simple torque boost	—
1510h	2nd torque boost selection	A241	R/W		
104Bh	Manual torque boost voltage	A042	R/W	0 to 200	0.1 [%]
1511h	2nd manual torque boost voltage	A242	R/W		
104Ch	Manual torque boost frequency	A043	R/W	0 to 500	0.1 [%]
1512h	2nd manual torque boost frequency	A243	R/W		
104Dh	V/f characteristics selection	A044	R/W	00: VC 01: 1.7th power of VP 06: Special VP	—
1513h	2nd V/f characteristics selection	A244	R/W		
104Eh	Output voltage gain	A045	R/W	20 to 100	1. [%]
1514h	2nd output voltage gain	A245	R/W		
1051h	DC injection braking selection	A051	R/W	00: Disabled 01: Enabled during stop 02: Output frequency<A052 DB	—
1052h	DC injection braking frequency	A052	R/W	0 to 600	0.1 [Hz]
1053h	DC injection braking delay time	A053	R/W	0 to 50	0.1 [s]
1054h	DC injection braking power	A054	R/W	0 to 100	1. [%]
1055h	DC injection braking time	A055	R/W	0 to 600	0.1 [s]
1056h	DC injection braking method selection	A056	R/W	00: Edge operation 01: Level operation	—
105Ah	Frequency upper limit	A061	R/W	0.0/Frequency lower limit : A062 x 10 to Maximum frequency : A004 x 10	0.1 [Hz]
1517h	2nd frequency upper limit	A261	R/W	0.0/2nd frequency lower limit : A262 x 10 to 2nd max. frequency : A204 x 10	0.1 [Hz]
105Bh	Frequency lower limit	A062	R/W	0.0/Starting frequency : b082 x 10 to Frequency upper limit : A061 x 10	0.1 [Hz]
1518h	2nd frequency lower limit	A262	R/W	0.0/Starting frequency : b082 x 10 to 2nd frequency upper limit : A261x10	0.1 [Hz]

4-2 Function Mode

Register No.	Function name	Parameter No.	R/W Function	Monitor or data range	Resolution
105Dh 1060h 1063h	Jump frequency 1 Jump frequency 2 Jump frequency 3	A063, A065, A067	R/W	0 to 4000	0.1 [Hz]
105Eh 1061h 1064h	Jump frequency width 1 Jump frequency width 2 Jump frequency width 3	A064, A066, A068	R/W	0 to 100	0.1 [Hz]
1068h	PID selection	A071	R/W	00: Disabled 01: Enabled	—
1069h	PID P gain	A072	R/W	2 to 50	0.1
106Ah	PID I gain	A073	R/W	0 to 1500	0.1 [s]
106Bh	PID D gain	A074	R/W	0 to 1000	0.1 [s]
106Ch	PID scale	A075	R/W	1 to 9999	0.01
106Dh	PID feedback selection	A076	R/W	00: Feedback (OI) 01: Feedback (O) 02: External communication 10: Operation function output	—
106Eh	Reverse PID function	A077	R/W	00: OFF (Deviation = Target value - Feedback value) 01: ON (Deviation = Feedback value - Target value)	—
106Fh	PID output limit function	A078	R/W	0 to 1000	0.1 [%]
1070h	AVR selection	A081	R/W	00: Always ON 01: Always OFF 02: OFF during deceleration	—
1071h	AVR voltage selection	A082	R/W	200-V class 0: 200 1: 215 2: 220 3: 230 4: 240 400-V class 0: 380 1: 400 2: 415 3: 440 4: 460 5: 480	—
1072h	RUN mode selection	A085	R/W	00: Normal operation 01: Energy-saving operation	—
1073h	Energy-saving response/ accuracy adjustment	A086	R/W	0 to 1000	0.1 [%]
1074h	Acceleration time 2	A092 (MSB)	R/W	1 to 300000 The second decimal place is ignored when the value is over 10000 (100.0 seconds).	0.01 [s]
1075h		A092 (LSB)	R/W		
1519h	2nd acceleration time 2	A292 (MSB)	R/W	1 to 300000 The second decimal place is ignored when the value is over 10000 (100.0 seconds).	0.01 [s]
151Ah		A292 (LSB)	R/W		

Register No.	Function name	Parameter No.	R/W Function	Monitor or data range	Resolution
1076h	Deceleration time 2	A093 (MSB)	R/W	1 to 300000 The second decimal place is ignored when the value is over 10000 (100.0 seconds).	0.01 [s]
1077h		A093 (LSB)	R/W		
151Bh	2nd deceleration time 2	A293 (MSB)	R/W	1 to 300000 The second decimal place is ignored when the value is over 10000 (100.0 seconds).	0.01 [s]
151Ch		A293 (LSB)	R/W		
1078h	2-step acceleration/ deceleration selection	A094	R/W	00: Switched via terminal 2CH 01: Switched by setting	—
151Dh	2nd 2-step acceleration/ deceleration selection	A294	R/W		
107Ah	2-step acceleration frequency	A095	R/W	0 to 4000	0.1 [Hz]
151Fh	2nd 2-step acceleration frequency	A295	R/W		
107Ch	2-step deceleration frequency	A096	R/W	0 to 4000	0.1 [Hz]
1521h	*2nd 2-step deceleration frequency	A296	R/W		
107Dh	Acceleration pattern selection	A097	R/W	00: Line 01: S-shape curve	—
107Eh	Deceleration pattern selection	A098	R/W	00: Line 01: S-shape curve	—
1080h	OI start frequency	A101	R/W	0 to 4000	0.1 [Hz]
1082h	OI end frequency	A102	R/W	0 to 4000	0.1 [Hz]
1083h	OI start ratio	A103	R/W	0 to 100	1. [%]
1084h	OI end ratio	A104	R/W	0 to 100	1. [%]
1085h	OI start selection	A105	R/W	00: Start frequency A101 01: 0 Hz	—
108Eh	Operation frequency input A setting	A141	R/W	00: Digital Operator (F001) 01: Digital Operator (volume) 02: Input O 03: Input OI 04: RS485 communications	—
108Fh	Operation frequency input B setting	A142	R/W		
1090h	Operator selection	A143	R/W	00: Addition (A + B) 01: Subtraction (A - B) 02: Multiplication (A × B)	—
1091h	Frequency addition amount	A145	R/W	0 to 4000	0.1 [Hz]
1093h	Frequency addition direction	A146	R/W	00: Adds the A145 value to the output frequency 01: Subtract A145 value from output frequency	—
1095h	VR start frequency	A151	R/W	0 to 4000	0.1 [Hz]
1097h	VR end frequency	A152	R/W	0 to 4000	0.1 [Hz]
1098h	VR start ratio	A153	R/W	0 to 100	1. [%]
1099h	VR end ratio	A154	R/W	0 to 100	1. [%]
109Ah	VR start selection	A155	R/W	0, 1	-

4-2 Function Mode

Register No.	Function name	Parameter No.	R/W Function	Monitor or data range	Resolution
10A5h	Retry selection	b001	R/W	00: Alarm 01: 0 Hz start 02: Frequency matching restart 03: Trip after frequency matching deceleration stop	—
10A6h	Allowable momentary power interruption time	b002	R/W	3 to 250	0.1 [s]
10A7h	Retry wait time	b003	R/W	3 to 1000	0.1 [s]
10A8h	Momentary power interruption/undervoltage trip during stop selection	b004	R/W	00: Disabled 01: Enabled	—
10A9h	Momentary power interruption retry time selection	b005	R/W	00: 16 times 01: No limit	—
1170h	Starting frequency at Active Frequency Matching restart	b011	R/W	00: Frequency at interruption 01: Max. frequency 02: Set frequency	—
10ADh	Electronic thermal level	b012	R/W	2000 to 10000	0.01 [%]
1527h	2nd electronic thermal level	b212	R/W	Set the rated current to 10000	
10AEh	Electronic thermal characteristics selection	b013	R/W	00: Reduced torque characteristics 1 01: Constant torque characteristics	—
1528h	2nd electronic thermal characteristics selection	b213	R/W	02: Reduced torque characteristics 2	—
10B5h	Overload limit selection	b021	R/W	00: Disabled 01: Enabled in acceleration/constant speed operation	—
1529h	2nd overload limit selection	b221	R/W	02: Enabled in constant speed operation	—
10B6h	Overload limit level	b022	R/W	2000 to 15000	0.01 [%]
152Ah	2nd overload limit level	b222	R/W	Set the rated current to 10000	
10B7h	Overload limit parameter	b023	R/W	1 to 300	0.1 [s]
152Bh	2nd overload limit parameter	b223	R/W		
10BBh	Overload limit source selection	b028	R/W	00: Set values in b022 01: Input O terminal	—
152Ch	2nd overload limit source selection	b228	R/W	00: Set values in b222 01: Input O terminal	—
1171h	Deceleration rate constant at Active Frequency Matching restart	b029	R/W	1 to 30000	0.1 [s]
1172h	Active Frequency Matching restart level	b030	R/W	200 to 20000	0.01 [%]
10BCh	Soft lock selection	b031	R/W	00: Data other than b031 cannot be changed when terminal SFT is ON. 01: Data other than b031 and the specified frequency parameter cannot be changed when terminal SFT is ON. 02: Data other than b031 cannot be changed. 03: Data other than b031 and the specified frequency parameter cannot be changed. 10: Data other than parameters changeable during operation cannot be changed.	—

Register No.	Function name	Parameter No.	R/W Function	Monitor or data range	Resolution
10C9h	Selection of non-stop function at momentary power interruption	b050	R/W	00: Disabled 01: Enabled (Stop) 02: Enabled (Restart)	—
10CAh	Starting voltage of non-stop function at momentary power interruption	b051	R/W	0 to 10000	0.1 [V]
10CBh	Stop deceleration level of non-stop function at momentary power interruption	b052	R/W	0 to 10000	0.1 [V]
10CCh	Deceleration time of non-stop function at momentary power interruption	b053	R/W	1 to 30000	0.1 [s]
10CEh	Deceleration starting width of non-stop function at momentary power interruption	b054	R/W	0 to 100	0.1 [Hz]
1173h	Overvoltage protection proportional gain during deceleration	b055	R/W	2 to 50	0.1
1174h	Overvoltage protection integral time during deceleration	b056	R/W	0 to 1500	0.1 [s]
10CFh	AM adjustment	b080	R/W	0 to 255	—
10D1h	Starting frequency	b082	R/W	5 to 99	0.1 [Hz]
10D2h	Carrier frequency	b083	R/W	20 to 120	0.1 [kHz]
10D3h	Initialization selection	b084	R/W	00: Clears the trip monitor 01: Initializes data 02: Clears the trip monitor and initializes data	—
10D4h	Initialization parameter selection	b085	R/W	01: Fixed *Do not change.	—
10D5h	Frequency conversion coefficient	b086	R/W	1 to 999	0.1
10D6h	STOP key selection	b087	R/W	00: Enabled 01: Disabled	—
10D7h	Free-run stop selection	b088	R/W	00: 0 Hz start 01: Active Frequency Matching restart	—
10D8h	Monitor display selection	b089	R/W	01: Output frequency monitor 02: Output current monitor 03: Rotation direction monitor 04: PID feedback value monitor 05: Multi-function input monitor 06: Multi-function output monitor 07: Frequency conversion monitor	—
10DAh	Stop selection	b091	R/W	00: Deceleration→Stop 01: Free-run stop	—
10DBh	Cooling fan control	b092	R/W	00: Always ON 01: ON during RUN 02: Depends on the fin temperature	—
10F5h	Overvoltage LAD stop function	b130	R/W	00: Disabled 01: Enabled	—
10F6h	Overvoltage LAD stop function level setting	b131	R/W	200-V class: 330 to 395, 400-V class: 660 to 790	1. [V]

4-2 Function Mode

Register No.	Function name	Parameter No.	R/W Function	Monitor or data range	Resolution
1176h	Overvoltage protection function selection during deceleration	b133	R/W	00: Disabled 01: Enabled	—
1177h	Overvoltage protection level setting during deceleration	b134	R/W	200-V class: 330. to 395. 400-V class: 660. to 790.	1. [V]
10F7h	Overcurrent suppression function	b140	R/W	00: Disabled 01: Enabled	—
10F8h	Automatic carrier reduction	b150	R/W	00: Disabled 01: Enabled	—
10F9h	Ready function selection	b151	R/W	00: RDY disabled 01: RDY enabled	—
1103h	Multi-function input 1 selection	C001	R/W	00: FW/01: RV/02: CF1/03: CF2/04: CF3/05: CF4/06: JG/07: DB/08: SET/09: 2CH/11: FRS/12: EXT/13: USP/15: SFT/16: AT/18: RS/19: PTC terminal 5 only/20: STA/21: STP/22: F/R/23: PID/24: PIDC/27: UP/28: DWN/29: UDC/31: OPE/50: ADD/51: F-TM/52: RDY/53: SP-SET/64: EMR(automatically allocated to terminal 3 if enabled)/255: NO	—
1532h	2nd multi-function input 1 selection	C201	R/W		
1104h	Multi-function input 2 selection	C002	R/W		
1533h	2nd multi-function input 2 selection	C202	R/W		
1105h	Multi-function input 3 selection	C003	R/W		
1534h	2nd multi-function input 3 selection	C203	R/W		
1106h	Multi-function input 4 selection	C004	R/W		
1535h	2nd multi-function input 4 selection	C204	R/W		
1107h	Multi-function input 5 selection	C005	R/W		
1536h	2nd multi-function input 5 selection	C205	R/W		
110Bh	Multi-function input 1 operation selection	C011	R/W	00: NO 01: NC	—
110Ch	Multi-function input 2 operation selection	C012	R/W		
110Dh	Multi-function input 3 operation selection	C013	R/W		
110Eh	Multi-function input 4 operation selection	C014	R/W		
110Fh	Multi-function input 5 operation selection	C015	R/W		
1114h	Multi-function output terminal 11 selection	C021	R/W	00: RUN/01: FA1/02: FA2/03: OL/04: OD/05: AL/06: Dc/07: FBV/08: NDc/09: LOG/10: ODc(Do not use.)/43: LOC	—
1119h	Relay output (AL2, AL1) function selection	C026	R/W		
111Bh	AM selection	C028	R/W	00: F (Output frequency) 01: A (Output current)	—
111Dh	Multi-function output terminal 11 contact selection	C031	R/W	00: NO 01: NC	—
1122h	Relay output (AL2, AL1) contact selection	C036	R/W	00: NO 01: NC	—

Register No.	Function name	Parameter No.	R/W Function	Monitor or data range	Resolution
1178h	Light load signal output mode	C038	R/W	00: Enabled during acceleration/ deceleration/constant speed 01: Enabled only during constant speed	—
1179h	Light load detection level	C039	R/W	0 to 20000 Set to 10000 at rated current	0.01 [%]
1124h	Overload warning level	C041	R/W	0 to 20000	0.01 [%]
153Ah	2nd overload warning level	C241	R/W	Set to 10000 at rated current	
1126h	Arrival frequency during acceleration	C042	R/W	0 to 4000	0.1 [Hz]
1128h	Arrival frequency during deceleration	C043	R/W	0 to 4000	0.1 [Hz]
1129h	PID deviation excessive level	C044	R/W	0 to 1000	0.1 [%]
112Eh	PID FB upper limit	C052	R/W	0 to 1000	0.1 [%]
112Fh	PID FB lower limit	C053	R/W	0 to 1000	0.1 [%]
1137h	Operator/ModBus selection	C070	—	Do not change through ModBus communication. For setting, refer to "ModBus Setting" (4-65).	—
1138h	Communication speed selection (Baud rate selection)	C071	—		
1139h	Communication station No. selection	C072	—		
113Bh	Communication parity selection	C074	—		
113Ch	Communication stop bit selection	C075	—		
113Dh	Communication error selection	C076	—		
113Eh	Communication error timeout	C077	—		
113Fh	Communication wait time	C078	—		
1141h	O adjustment	C081	R/W	0 to 2000	0.1 [%]
1142h	OI adjustment	C082	R/W	0 to 2000	0.1 [%]
1145h	AM offset adjustment	C086	R/W	0 to 100	0.1 [V]
—	Not used	C091	—	Do not change.	—
1149h	UP/DWN selection	C101	R/W	00: OFF/01: ON	—
114Ah	Reset selection	C102	R/W	00: Trip reset at power-on 01: Trip reset when the power is OFF 02: Enabled only during trip (Reset when the power is ON.)	—
1150h	Logic operation function A input	C141	R/W	00: RUN/01: FA1/02: FA2/03: OL/04: OD/05: AL/06: Dc/07: FBV/08: NDC/10: ODc(Do not use.)/43: LOC	—
1151h	Logic operation function B input	C142	R/W		
1152h	Logic operator selection	C143	R/W	00: AND/01: OR/02: XOR	—
1153h	Output terminal 11 ON delay	C144	R/W	0 to 1000	0.1 [s]
1154h	Output terminal 11 OFF delay	C145	R/W	0 to 1000	
1157h	Relay output ON delay	C148	R/W	0 to 1000	
1158h	Relay output OFF delay	C149	R/W	0 to 1000	

4-2 Function Mode

Register No.	Function name	Parameter No.	R/W Function	Monitor or data range	Resolution
1165h	Motor capacity selection	H003	R/W	00: 0.2/02: 0.4/04: 0.75/ 06: 1.5/07: 2.2/09: 3.7/ 11: 5.5/12: 7.5	—
1541h	2nd motor capacity selection	H203	R/W	00: 0.2/02: 0.4/04: 0.75/ 06: 1.5/07: 2.2/09: 3.7/ 11: 5.5/12: 7.5	—
1166h	Motor pole number selection	H004	R/W	2/4/6/8	1 [pole]
1542h	2nd motor pole number selection	H204	R/W	2/4/6/8	1 [pole]
1168h	Stabilization parameter	H006	R/W	0. to 255.	1. [%]
1544h	2nd stabilization parameter	H206	R/W	0. to 255.	1. [%]
0900h	Enter command	—	W	Indefinite value	—

Chapter 5

Maintenance Operations

5-1	Special Display List (Error Codes)	5-2
5-2	Troubleshooting.....	5-6

5-1 Special Display List (Error Codes)





Error Code List

Name	Description	Display on Digital Operator
Overcurrent trip	If the motor is restrained, or rapidly accelerated or decelerated, a large current flows through the Inverter, which may result in breakdown. To avoid this, an overcurrent protection circuit works to shut off the Inverter output.	Constant speed
		Deceleration
		Acceleration
		Others
Overload trip	If an Inverter output current is detected and the motor is overloaded, an electronic thermal inside the Inverter operates to shut off the Inverter output. •After a trip occurs, normal operation is restored in 10 seconds by resetting the Inverter.	
Overvoltage trip	If the incoming voltage and regenerative energy from the motor are too high, a protection circuit works to shut off the Inverter output when the voltage on the converter exceeds the specified level.	
EEPROM error	Shuts off the output if an error occurs in the EEPROM built into the Inverter due to external noise and abnormal temperature rise. •Check the set data again if the E 08 error occurs. •If the power is shut off during data initialization, an EEPROM error E 08 may occur when the power is next turned on. Shut off the power after completing data initialization.	
Undervoltage trip	Shuts off the output if the incoming voltage drops below the specified level, causing the control circuit not to work properly during a momentary power interruption.	
CPU error	Shuts off the output if the internal CPU has malfunctioned. •If the multi-function output terminal (relay terminal) is set to 05 (alarm), the signal may not be output during the CPU error E 11 . In this case, no data is stored in the trip monitor. •The same thing could happen if AL (05) is allocated to the relay output terminal. Again, no data is stored.	
External trip	If an error occurs in the external equipment or devices, the Inverter receives the signal, and the output is shut off. (Available with the external trip function selected)	
USP trip	Appears if the Inverter is turned on with the RUN command being input. (Available with the USP function selected) •If an undervoltage trip E 09 occurs with the USP terminal turned ON, a USP trip E 13 occurs after a trip reset. Reset again to release the trip.	

5-1 Special Display List (Error Codes)

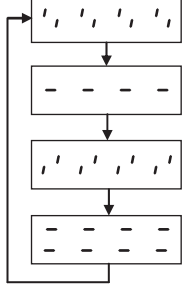
Name	Description	Display on Digital Operator
Ground fault trip	Shuts off the output if a ground fault between the Inverter output unit and the motor is detected when turning on the power. •The ground fault trip E 14 cannot be released with the reset input. Shut off the power and check the wiring.	E 14
Incoming overvoltage trip	Appears if the incoming voltage has remained high for 100 seconds while the Inverter output is stopped.	E 15
Temperature error	Shuts off the output if the temperature has risen in the main circuit due to malfunction of the cooling fan or other reasons.	E 21
Driver error	Shuts off the output if overcurrent is detected in the main circuit.	E 30
Thermistor error	While the thermistor input function is used, this detects the resistance of the external thermistor and shuts off the Inverter output.	E 35
Emergency shutoff	With the emergency shutoff selected (DIP switch on the control board SW8 = ON), this error appears when an emergency shutoff signal is input from multi-function input terminal 3.	E 37
Communications error	Occurs when the communication watchdog timer times out.	E 60

Other Displays

Name	Description	Display on Digital Operator
Reset	Appears with the [RS] terminal turned ON or during initialization.	
Undervoltage standby	Appears when the Inverter is in the undervoltage standby condition or with the power shut off.	
Restart during momentary power interruption Restart during trip	The restart function is in operation.	
Setting initialization	Appears while the set values are being initialized.	
Trip monitor initialization	Appears while the trip monitor is being initialized.	
No data (Trip monitor)	Appears if no data exists. (Trip monitor)	
Communications error	Appears if an error occurs between the Digital Operator and the Inverter.	

5 Maintenance Operations

Trip Monitor Display

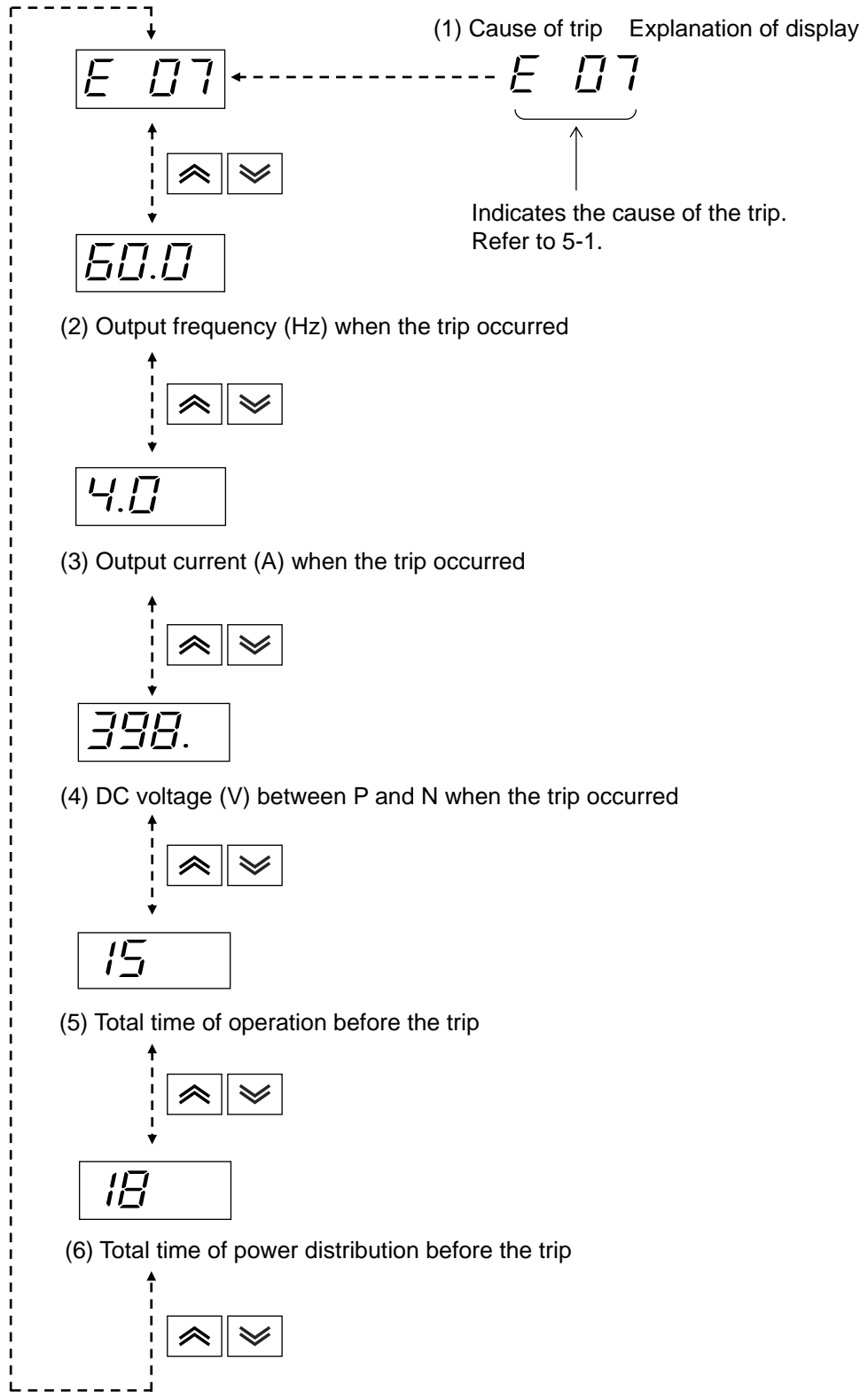

5-2 Troubleshooting

Situation		Possible cause	Remedy
The motor doesn't work.	No voltage observed for Inverter outputs U/T1, V/T2, and W/T3.	<ul style="list-style-type: none"> Is the A001 setting (frequency reference selection) correct? Is the A002 setting (RUN command selection) correct? Is power supplied to terminals R/L1, S/L2, and T/L3? If so, the POWER LED indicator should light up. Does the display show "E ***"? Is the allocation of the multi-function input correct? Is the RUN key (RUN command) turned on? Are FW (or RV) input and terminal L or PCS connected? Is the frequency set with F001 selected? Is the potentiometer connected to terminals H/O/L? Are RS and FRS inputs still turned on? 	<ul style="list-style-type: none"> Check the A001 setting. Check the A002 setting. Check the connections of terminals R/L1, S/L2, T/L3 and U/T1, V/T2, W/T3. Turn on the power. Press the Mode key to confirm the status, and then reset. Check the allocation of the multi-function inputs: C001 to C005 Turn on the RUN key (RUN command). Connect FW (or RV) input to terminal L or PCS. Press the key to set the frequency. If terminal mode is selected, set the potentiometer to H/O/L. Turn off these inputs.
	Voltage observed for Inverter outputs U/T1, V/T2, and W/T3.	<ul style="list-style-type: none"> Is the motor restrained? Or is it overloaded? 	<ul style="list-style-type: none"> Release the restraint and reduce the load. Operate the motor separately.
Motor rotation is in reverse.		<ul style="list-style-type: none"> Are output terminals U/T1, V/T2, and W/T3 correct? Is the phase sequence of the motor U/T1, V/T2, W/T3, and is the rotation in forward or reverse? Is the control circuit terminal correct? Is F004 set correctly in the motor rotation direction selection via the Digital Operator? 	<ul style="list-style-type: none"> Connect according to the motor phase sequence. (Generally, the sequence is U/T1, V/T2, and W/T3 in forward.) Select FW for forward and RV for reverse.
		<ul style="list-style-type: none"> Does not rise even after the frequency setting unit is turned on with correct wiring. Is the motor overloaded? 	<ul style="list-style-type: none"> Replace the frequency setting unit. Reduce the load. Motor rpm becomes lower than the set value due to the limit function if overloaded.
Motor rotation speed does not rise.		<ul style="list-style-type: none"> Does not rise even after the frequency setting unit is turned on with correct wiring. Is the motor overloaded? 	<ul style="list-style-type: none"> Replace the frequency setting unit. Reduce the load. Motor rpm becomes lower than the set value due to the limit function if overloaded.

Situation		Possible cause	Remedy
Rotation is unstable.		<ul style="list-style-type: none"> • Is the load too variable? • Is the power voltage variable? • Is this situation observed at a specific frequency? 	<ul style="list-style-type: none"> • Increase the capacity of both the motor and Inverter. • Reduce the variation. • Finely adjust the output frequency.
Motor rotation doesn't match.		<ul style="list-style-type: none"> • Is the maximum frequency setting correct? 	<ul style="list-style-type: none"> • Check the V/F pattern according to the motor specifications. • Check the transmission gear ratio.
Data value is abnormal.	Does not change with data set.	<ul style="list-style-type: none"> • After changing the data using the Increment/Decrement key, the Enter key was not pressed before the power was turned off. 	<ul style="list-style-type: none"> • Input data again and press the Enter key.
		<ul style="list-style-type: none"> • Was the power turned off within 6 seconds of changing the data and pressing the Enter key? 	<ul style="list-style-type: none"> • Wait 6 seconds or more after changing data and pressing the Enter key before power off
Data would not change.	<ul style="list-style-type: none"> • Frequency would not change. • Can neither operate nor stop. 	<ul style="list-style-type: none"> • Is the selection between operator and terminal modes correct? 	<ul style="list-style-type: none"> • Check the selections of the setting modes of A001 and A002.
	Cannot change data.	<ul style="list-style-type: none"> • Is the soft lock activated? • Is the soft lock (data: 02 and 03) set in soft lock selection b031? • Is it tripped? 	<ul style="list-style-type: none"> • Reset the SFT terminal. • Set b031 to 00 or 01. • Turn off the switch. • Reset the trip.

Notes on Data Setting:

Wait 6 seconds or more after changing data and pressing the Enter key to store it.



The data may not be set correctly if you operate any key, perform the reset, or disconnect the power supply within 6 seconds.



Chapter 6

Inspection and Maintenance

6-1	Inspection and Maintenance	6-2
6-2	Storage.....	6-8

6-1 Inspection and Maintenance

 WARNING	
	Do not remove the front cover during the power supply and 5 minutes after the power shutoff. Doing so may result in a serious injury due to an electric shock.
	Do not change wiring, mode change switches (S7, S8), optional devices or replace cooling fans while the input power is being supplied. Doing so may result in a serious injury due to an electric shock.

 CAUTION	
	Do not touch the Inverter fins, braking resistors and the motor, which become too hot during the power supply and for some time after the power shutoff. Doing so may result in a burn.
	Do not dismantle, repair or modify the product. Doing so may result in an injury.

Safety Information

■ Maintenance and Inspection

- Be sure to confirm safety before conducting maintenance, inspection or parts replacement.

Precautions for Use

■ Operation Stop Command

- Provide a separate emergency stop switch because the STOP key on the Digital Operator is valid only when function settings are performed.
- When checking a signal during the power supply and the voltage is erroneously applied to the control input terminals, the motor may start abruptly. Be sure to confirm safety before checking a signal.

■ Product Disposal

- Comply with the local ordinance and regulations when disposing of the product.

General Precautions

- Always keep the Inverter and area clean to prevent dust from entering.
- Take utmost care not to have the wires disconnected or connected wrongly. Tightly fix the terminals and connectors.
- Do not expose the electronic device to humidity, oil, dust and/or iron powder or shavings. Doing so may damage the insulation and result in an accident.
- Do not pull on the cables in connecting/disconnecting the connectors (cooling fan and control PCB cables). Doing so may result in fire or injury due to cable damage.

Inspection Item

- Daily inspection
- Periodic inspection (about every year)
- Insulation resistance test (about every two years)

- Megger test

Short-circuit the terminals as below to conduct the test.

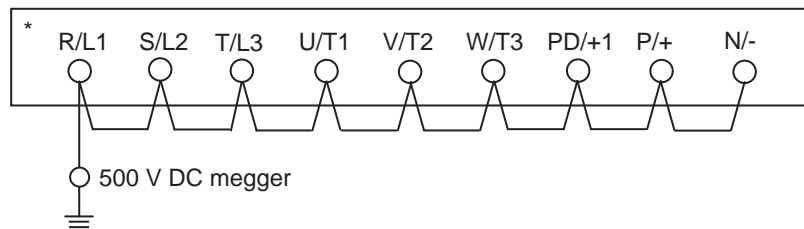

* For 3G3JX-AB□□□'s terminal symbols, R/L1 corresponds to L1, S/L2 to L2, and T/L3 to N/L3.

- Make sure that the resistance between the main circuit terminal and ground is 5 MΩ or more at 500 VDC megger.
- Do not conduct a withstand voltage test on any part of the Inverter. Doing so may result in the deterioration of parts.

*To shorten non-operation time, we recommend always keeping a spare Inverter ready.

■Daily Inspection and Periodic Inspection

Inspection part	Inspection item	Inspection point	Inspection period		Inspection method	Criteria	Standard replacement period	Meter
			Daily	Periodic				
General	Ambient environment	Check ambient temperature, as well as checking for humidity, dust, hazardous gases, oil mist, etc.	✓		Monitoring, visual inspection	Ambient temperature -10°C to +40°C With no freezing Ambient humidity 20% to 90% With no condensation		Thermometer Hygrometer
	Entire device	Check that there are no abnormal vibrations or sounds.	✓		Visual or acoustic inspection		—	
	Power supply voltage	Check that the main circuit voltage is normal.	✓		Voltage measurement between terminals R/L1, S/L2 and T/L3 on the Inverter terminal block.	The following conditions must be satisfied: (200-V class) 200 to 240 V 50/60 Hz (400-V class) 380 to 480 V 50/60 Hz		Tester
Main circuit	General	Insulation resistance test (between main circuit terminal and ground terminal)		✓	Megger check (Refer to 6-3.)	5 M Ω min.		500 V DC megger
		Check that the screws are not loose.		✓	Tighten securely	Tightening torque (excluding terminal block) • M 3.5: 0.8 N•m • M 4 : 1.2 N•m • M 5 : 3.0 N•m	—	
		Check that no part has indications of overheating.		✓	Visual inspection			
	Terminal block	Check that there is no damage.		✓	Visual inspection	No faults		
	Smoothing capacitor	Check that there is no liquid leakage. Check that the safety valve has not come out. Check that there are no bulges.	✓ ✓ ✓		Visual inspection	No faults	*1	

*1. The life of the capacitor depends on ambient temperatures. Refer to the product life curve in Appendix-2. When the capacitor stops operating at the end of the product's life, the Inverter must be replaced.

*2. Clean the Inverter periodically. Accumulated dust in or on the cooling fan or heat sink can cause the Inverter to overheat.

Inspection part	Inspection item	Inspection point	Inspection period		Inspection method	Criteria	Standard replacement period	Meter
			Daily	Periodic				
Main circuit	Relay terminal block	Check that there is no abnormal sound during operation.		✓	Acoustic inspection	No faults	—	
	Resistor	Check that there are no large fissures or discoloration in the resistance insulation.		✓	Visual inspection	No faults	—	Tester
	Cooling fan	Check that there are no abnormal vibrations or sounds. Check that there is no dirt or dust.*2 Check that the fan is mounted correctly.	✓		Rotate manually when the power is off.	Smooth rotation	2 to 3 years	
✓				Visual inspection				
✓				Visual inspection				
Control circuit	Operation check	Check the balance of output voltage levels between phases in single Inverter run. Check that there are no errors in trip detection and the display circuit throughout the operation of sequence protection.		✓	Measure the phase-to-phase voltage between Inverter output terminals U/T1, V/T2, and W/T3.	Voltage difference between phases 2% max.		Digital multimeter Rectifier Voltmeter
				✓	Simulate the Inverter trip circuit output Ex) Use an external trip etc.	Operates with no faults	—	
	Parts check (including PCB)	General	Check that there are no abnormal odors or discoloration. Check that there is no significant rusting.		✓	Visual inspection	No faults	—
Capacitor		✓		Visual inspection	*1			

*1. The life of the capacitor depends on ambient temperatures. Refer to the product life curve in Appendix-2. When the capacitor stops operating at the end of the product's life, the Inverter must be replaced.

*2. Clean the Inverter periodically. Accumulated dust in or on the cooling fan or heat sink can cause the Inverter to overheat.

6-1 Inspection and Maintenance

Inspection part	Inspection item	Inspection point	Inspection period		Inspection method	Criteria	Standard replacement period	Meter
			Daily	Periodic				
Display	Digital Operator	Check that the display is clear. Check that there are no missing parts. Check that the LED indicators are lit properly.	✓		Visual inspection	Normal operation Display can be read	—	—



- *1. The life of the capacitor depends on ambient temperatures. Refer to the product life curve in Appendix-2. When the capacitor stops operating at the end of the product's life, the Inverter must be replaced.
- *2. Clean the Inverter periodically. Accumulated dust in or on the cooling fan or heat sink can cause the Inverter to overheat.

Measurement Methods of I/O Voltage, Current, and Electric Power

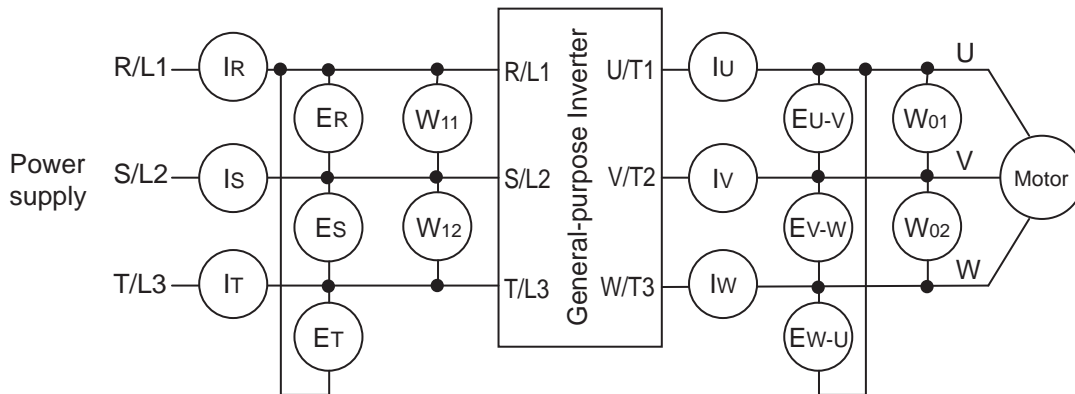
Below are general measurement devices for I/O voltage, current, and electric power. Measure effective values of fundamental wave for voltage, and all effective values for electric power.



Measurement item	Measurement point	Measurement device	Note	Measurement value reference
Power supply voltage E_i	Phase-to-phase voltage between R-S, S-T, and T-R (ER) (ES) (ET)	Moving-iron voltmeter or Rectifier voltmeter	Effective value of fundamental wave	Commercial current (200-V class) 200 to 240 V, 50/60 Hz (400-V class) 380 to 480 V, 50/60 Hz
Power supply current I_i	Current R, S, T (IR) (IS) (IT)	Moving iron ammeter	All effective values	
Input electric power W_i	Between R-S, S-T (W11) + (W12)	Electrodynamic wattmeter	All effective values	Two-wattmeter method

Measurement item	Measurement point	Measurement device	Note	Measurement value reference
Input power factor Pf_i	Calculated from the measured values of power supply voltage E_i , power supply current I_i , and input electric power W_i . $Pf_i = \frac{W_i}{\sqrt{3} \cdot E_i \cdot I_i} \times 100 (\%)$			
Output voltage E_o	Between U-V, V-W, W-U (EU) (EV) (EW)	 Rectifier voltmeter	All effective values	
Output current I_o	Current U, V, W (IU) (IV) (IW)	 Moving-iron voltmeter	All effective values	
Output electric power W_o	Between U-V, V-W (W01) + (W02)	 Electrodynamic wattmeter	All effective values	Two-wattmeter method
Output power factor Pf_o	Calculated from the measured values of output voltage E_o , output current I_o , and output electric power W_o . $Pf_o = \frac{W_o}{\sqrt{3} \cdot E_o \cdot I_o} \times 100 (\%)$			

Note 1: For voltage, use a measurement device that displays effective values of fundamental wave. For current and electric power, use a measurement device that displays all effective values.

Note 2: The Inverter output waveform, under PWM control, may have a margin of error, especially at a low frequency.

Use the above measurement devices and methods to ensure accuracy.

Note 3: General-purpose testers are not applicable for measurement in many cases.

6-2 Storage

Ensure the following conditions when storing the Inverter temporarily or for a long term after purchase.

- Ensure the following conditions when storing the Inverter temporarily for transportation.
 - Storage temperature : -20°C to 60°C
 - Humidity : 20% to 90% RH
 - (Without condensation or freezing due to rapid temperature change)
- Do not store this unit in a place with dust, direct sunshine, corrosive gas, or combustible gas.
- The Inverter's smoothing capacitor characteristics will deteriorate if left unused for a long time, even with no power distribution, which will shorten its life.

Chapter 7

Specifications

7-1	Standard Specification List.....	7-2
7-2	Measurement Method of Output Voltage	7-6
7-3	Dimensional Drawing.....	7-7
7-4	Options.....	7-13

7-1 Standard Specification List

■3-phase 200-V Class

Item		3-phase 200-V class							
Model name (3G3JX-)		A2002	A2004	A2007	A2015	A2022	A2037	A2055	A2075
Applicable motor capacity ^{*1}	kW	0.2	0.4	0.75	1.5	2.2	3.7	5.5	7.5
	HP	1/4	1/2	1	2	3	5	7.5	10
Rated output capacity (kVA)	200V	0.4	0.9	1.3	2.4	3.4	5.5	8.3	11.0
	240 V	0.5	1.0	1.6	2.9	4.1	6.6	9.9	13.3
Rated input voltage		3-phase (3-wire) 200 V -15% to 240 V +10%, 50/60 Hz ±5%							
Built-in filter		-							
Rated input current (A)		1.8	3.4	5.2	9.3	13.0	20.0	30.0	40.0
Rated output voltage ^{*2}		3-phase: 200 to 240 V (Proportional to input voltage)							
Rated output current (A)		1.4	2.6	4.0	7.1	10.0	15.9	24.0	32.0
Weight [kg]		0.8	0.9	1.1	2.2	2.4	2.4	4.2	4.2
Cooling method		Self-cooling			Forced-air-cooling				
Braking torque	At short-time deceleration ^{*3} At capacitor feedback	Approx. 50%			Approx. 20% to 40%		Approx. 20%		
	DC injection braking	Injection braking frequency/time, braking force variable, frequency control available							

■3-phase 400-V Class

Item		3-phase 400-V class							
Model name (3G3JX-)		A4004	A4007	A4015	A4022	A4040	A4055	A4075	
Applicable motor capacity ^{*1}	kW	0.4	0.75	1.5	2.2	4.0	5.5	7.5	
	HP	1/2	1	2	3	5	7.5	10	
Rated output capacity (kVA)	380 V	0.9	1.6	2.5	3.6	5.6	8.5	10.5	
	480 V	1.2	2.0	3.1	4.5	7.1	10.8	13.3	
Rated input voltage		3-phase (3-wire) 380 V -15% to 480 V +10%, 50/60 Hz ±5%							
Built-in filter		EMC filter (EN61800-3 category C3)							
Rated input current (A)		2.0	3.3	5.0	7.0	11.0	16.5	20.0	
Rated output voltage ^{*2}		3-phase: 380 to 480 V (Proportional to input voltage)							
Rated output current (A)		1.5	2.5	3.8	5.5	8.6	13.0	16.0	
Weight [kg]		1.5	2.3	2.4	2.4	2.4	4.2	4.2	
Cooling method		Self-cooling			Forced-air-cooling				
Braking torque	At short-time deceleration ^{*3} At capacitor feedback	Approx. 50%			Approx. 20% to 40%		Approx. 20%		
	DC injection braking	Injection braking frequency/time, braking force variable, frequency control available							

■1-phase 200-V Class

Item		1-phase 200-V class				
Model name (3G3JX-)		AB002	AB004	AB007	AB015	AB022
Applicable motor capacity ^{*1}	kW	0.2	0.4	0.75	1.5	2.2
	HP	1/4	1/2	1	2	3
Rated output capacity (kVA)	200 V	0.4	0.9	1.3	2.4	3.4
	240 V	0.5	1.0	1.6	2.9	4.1
Rated input voltage		1-phase 200 V -15% to 240 V +10% 50/60 Hz ±5%				
Built-in filter		EMC FILTER (EN61800-3 category C1) Model without Built-in EMC filter is also available				
Rated input current (A)		1.8	3.4	5.2	9.3	13.0
Rated output voltage ^{*2}		3-phase: 200 to 240 V (Proportional to input voltage)				
Rated output current (A)		1.4	2.6	4.0	7.1	10.0
Weight [kg]		0.8	0.9	1.5	2.3	2.4
Cooling method		Self-cooling			Forced-air-cooling	
Braking torque	At short-time deceleration ^{*3} At capacitor feedback	Approx. 50%			Approx. 20% to 40%	
	DC injection braking	Injection braking frequency/time, braking force variable, frequency control available				

*1. The applicable motor is a 3-phase standard motor. For using any other type, be sure that the rated current does not exceed that of the Inverter.

*2. Output voltage decreases according to the level of the power supply voltage.

*3. The braking torque at the time of capacitor feedback is an average deceleration torque at the shortest deceleration (when it stops from 50 Hz), not a continuous regenerative torque. Also, the average deceleration torque varies depending on the motor loss. The value is reduced in operation at over 50 Hz. Note that no regenerative braking circuit is built into the Inverter. If you need a larger regenerative torque, use the optionally available regenerative braking unit and resistor. The regenerative braking unit should be used only for short-time regeneration.

Common Specifications

Item		Specifications	
Enclosure rating		Semi-closed (IP20)	
Control	Control method	Phase-to-phase sinusoidal modulation PWM	
	Output frequency range *1	0.5 to 400 Hz	
	Frequency precision *2	Digital command: ±0.01% of the max. frequency Analog command: ±0.4% of the max. frequency (25°C ± 10°C)	
	Frequency setting resolution	Digital setting: 0.1 Hz Analog setting: Max. frequency/1000	
	Voltage/Frequency characteristics	V/f characteristics (constant/reduced torque)	
	Overload current rating	150% for 1 min	
	Acceleration/Deceleration time	0.01 to 3000 s (line/curve selection), 2nd acceleration/deceleration setting available	
	Carrier frequency modification range	2 to 12 kHz	
	DC injection braking	Starts at a frequency lower than that in deceleration via the STOP command, at a value set lower than that during operation, or via an external input. (Level and time settable.)	
Protective functions		Overcurrent, overvoltage, undervoltage, electronic thermal, temperature error, ground-fault overcurrent at power-on state, overload limit, incoming overvoltage, external trip, memory error, CPU error, USP trip, communication error, overvoltage protection during deceleration, momentary power interruption protection, emergency shutoff	
Input signal	Digital Operator signal	Frequency settings	Setting with the FREQ adjuster and the Increment/Decrement keys on the Digital Operator, variable resistance from 1 to 2 kΩ (2 W), 0 to 10 V DC (input impedance 10 kΩ), 4 to 20 mA (input impedance 250 Ω), communication through an RS-485 port (ModBus communication). (Simultaneous inputs of O/OI are not acceptable. Also, do not connect the signal lines for inputs O and OI simultaneously.)
		Forward/Reverse Run/Stop	Forward/Stop via the RUN and STOP/RESET keys (parameter selection for Forward or Reverse), Reverse/Stop available at the time of multi-function input allocation (selectable from 1NO or 1NC), Run/Stop through external communication.
	Multi-function input		FW (forward), RV (reverse), CF1 to CF4 (multi-step speed setting), JG (jogging), DB (external DC injection braking), SET (2nd function), 2CH (2-step acceleration/deceleration), FRS (free run), EXT (external trip), USP (USP function), SFT (soft lock), AT (analog current input function selection), RS (reset), PTC (thermistor input), STA (3-wire startup), STP (3-wire stop), F/R (3-wire forward/reverse), PID (PID selection), PIDC (PID integral reset), UP (UP of UP/DWN function), DWN (DWN of UP/DWN function), UDC (data clear of UP/DWN function), OPE (forced OPE mode), ADD (frequency addition), F-TM (forced terminal block), RDY (operation ready), SP-SET (special setting), EMR (emergency shutoff)

Item		Specifications
Output signal	Multi-function output	RUN (signal during operation), FA1 (frequency arrival signal), FA2 (over set frequency arrival signal), OL (overload warning signal), OD (PID excess deviation signal), AL (alarm output), DC (analog input disconnection detection signal), FBV (PID FB status output), NDc (network error), LOG (logical operation result), ODc (Do not use.), LOC (light load detection signal)
	Frequency monitor	Analog output (0 to 10 V DC, 1 mA max.), Frequency/Current signals are selectable via the AM output terminal.
	Relay output	The relay (SPDT contact) outputs signals corresponding to the multi-function output.
Other functions	AVR function, V/f characteristic selection, upper/lower limit, 16-step speeds, starting frequency adjustment, jogging operation, carrier frequency adjustment, PID control, frequency jump, analog gain/bias adjustment, S-shape acceleration/deceleration, electronic thermal characteristics/level adjustment, retry function, simplified torque boost, trip monitor, soft lock function, frequency conversion display, USP function, 2nd control function, motor rotation speed UP/DWN, overcurrent suppression function	
General specifications	Ambient temperature	-10°C to 50°C (Both the carrier frequency and output current need to be reduced at over 40°C.)
	Ambient storage temperature	-20°C to 65°C (short-time temperature during transport)
	Humidity	20% to 90% RH
	Vibration	5.9 m/s ² (0.6G), 10 to 55 Hz (Complies with the test method specified in JIS C0040 (1999).)
	Location	At a maximum altitude of 1,000 m; indoors (without corrosive gases or dust)
	Applicable standard	Complies with UL, cUL, CE standards. (Insulation distance)
Options	Noise filter, AC/DC reactors, regenerative braking unit and resistor, etc.	

- *1. To operate the motor at over 50/60 Hz, contact the motor manufacturer to find out the maximum allowable number of revolutions.
- *2. For the stable control of the motor, the output frequency may exceed the maximum frequency set in A004 (A204) by 2 Hz max.

7-2 Measurement Method of Output Voltage

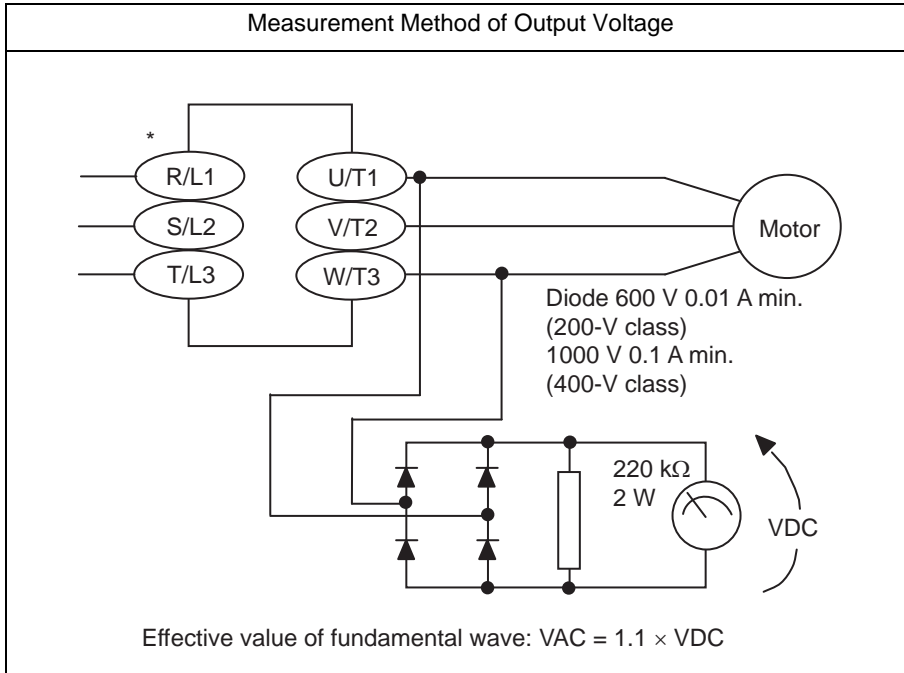

* For 3G3JX-AB□□□'s terminal symbols, use L1 and N.

7

Specifications

7-3 Dimensional Drawing

■3G3JX -A2002
AB002

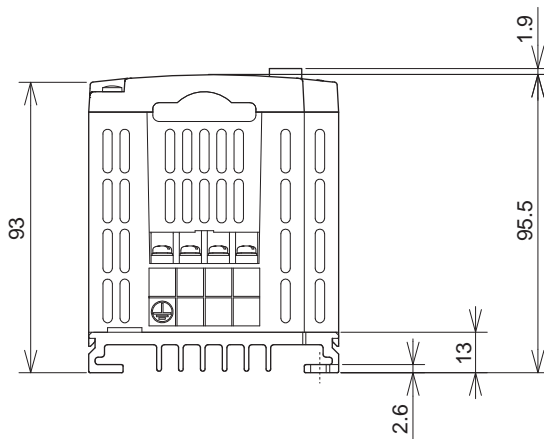
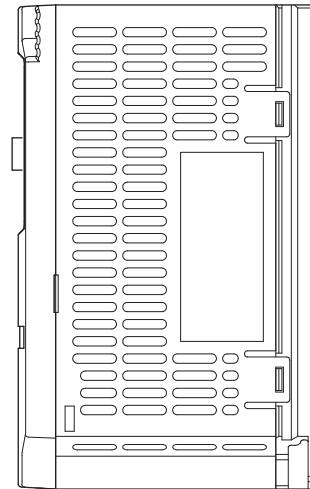
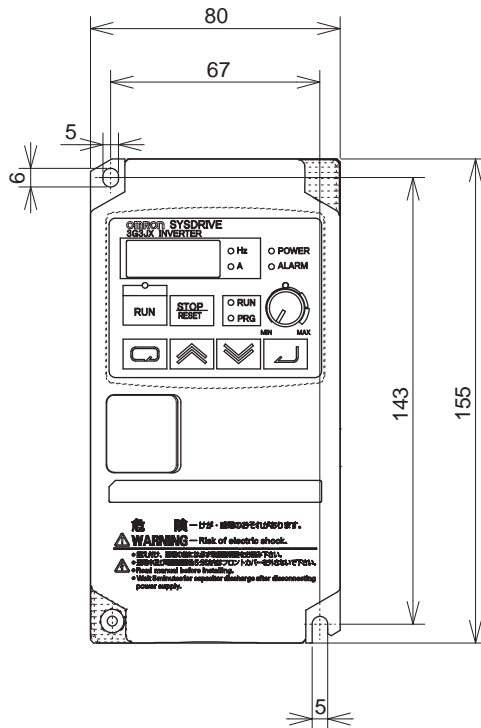

■3G3JX -A2004
AB004

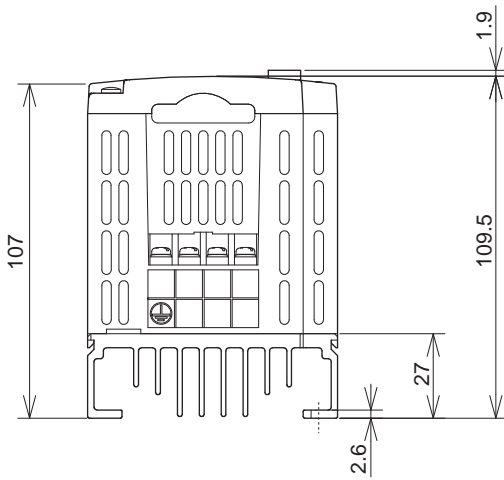
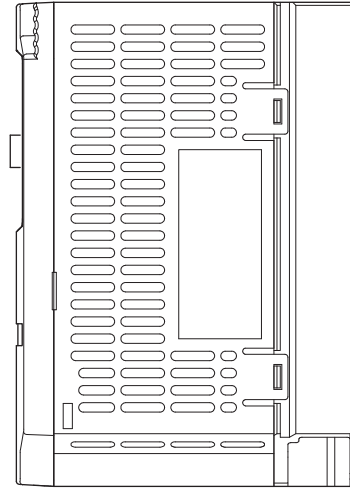
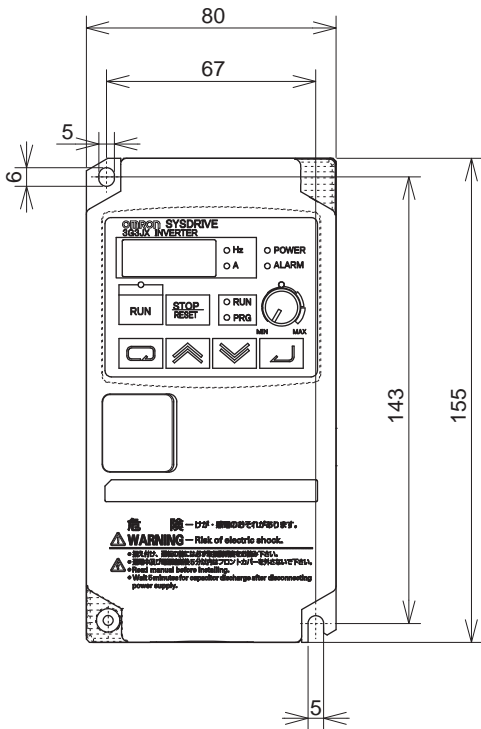

7

Specifications

■3G3JX -A2007

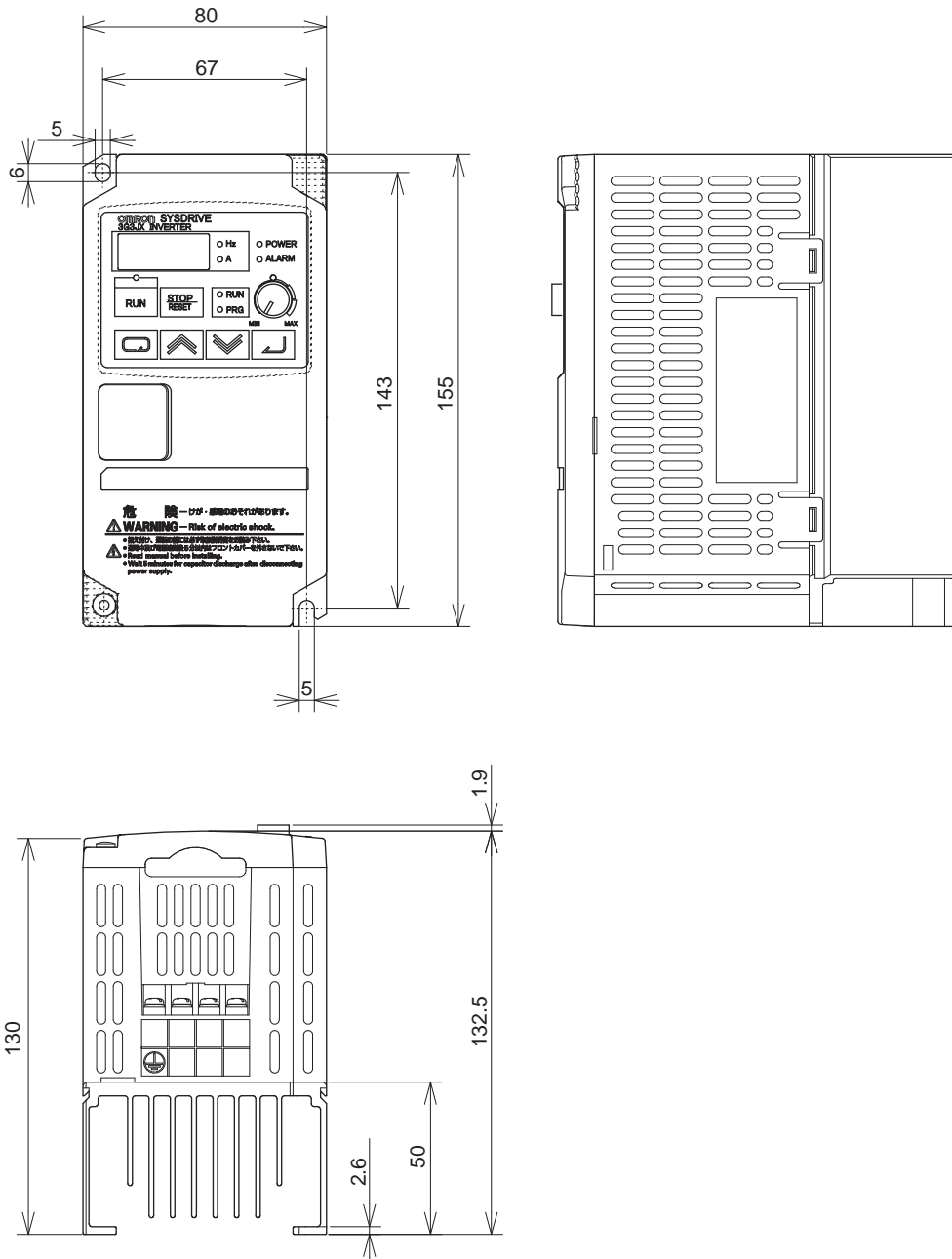

7-3 Dimensional Drawing

■ 3G3JX -A4004 -AB007

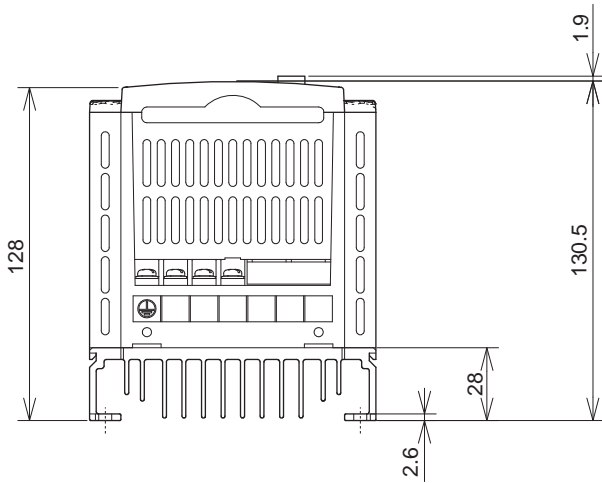
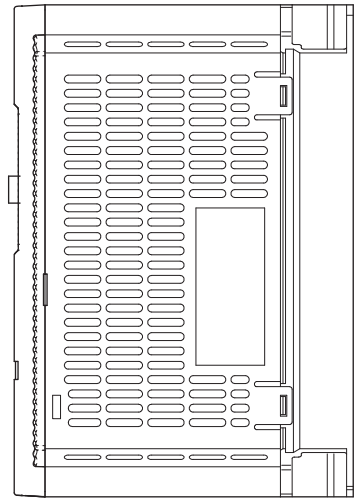
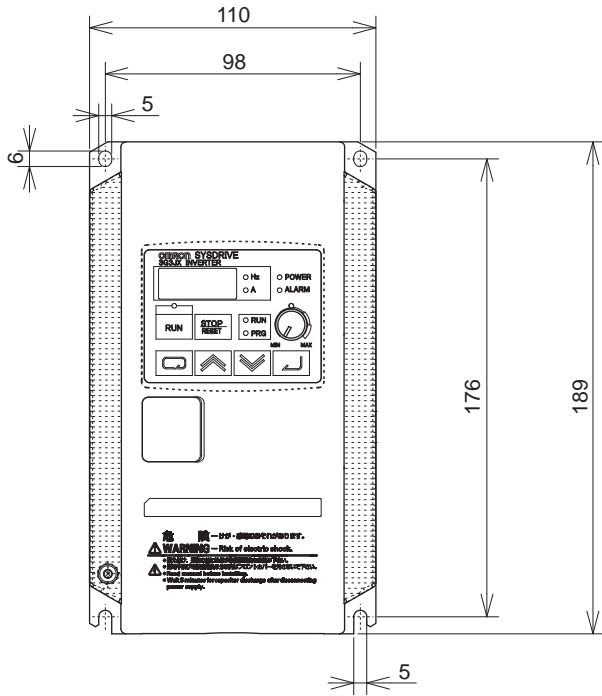

Specifications

7

■3G3JX -A2015/A2022/A2037
-A4007/A4015/A4022/A4040
-AB015/AB022

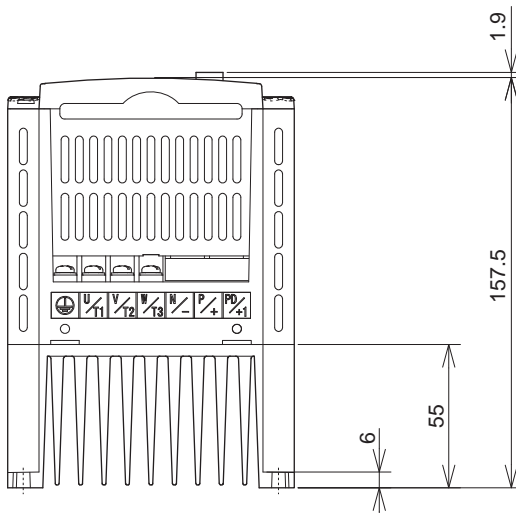
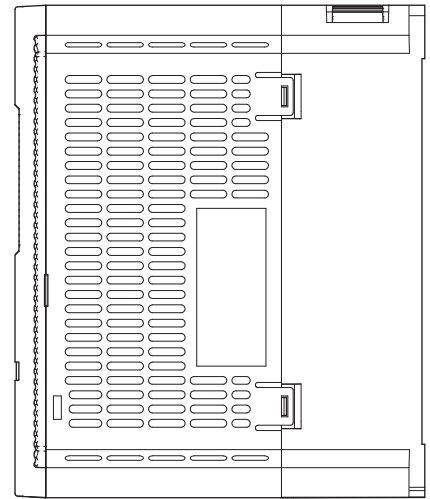
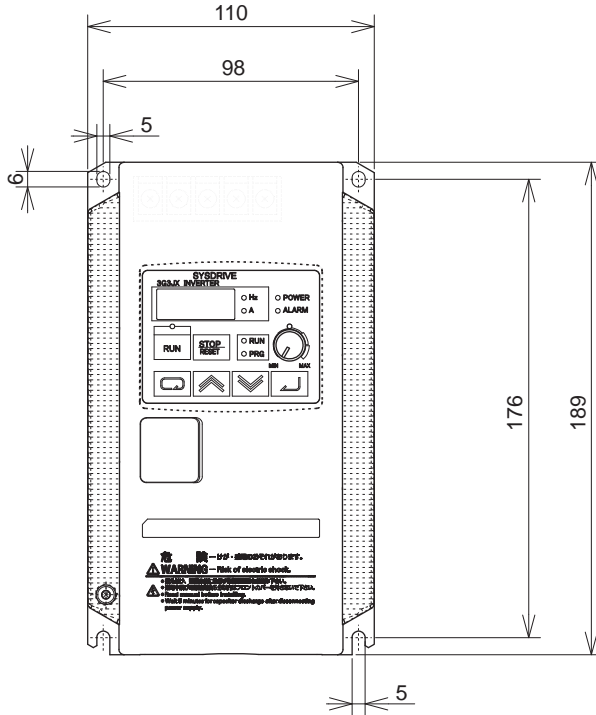

■ 3G3JX -A2055/A2075
-A4055/A4075

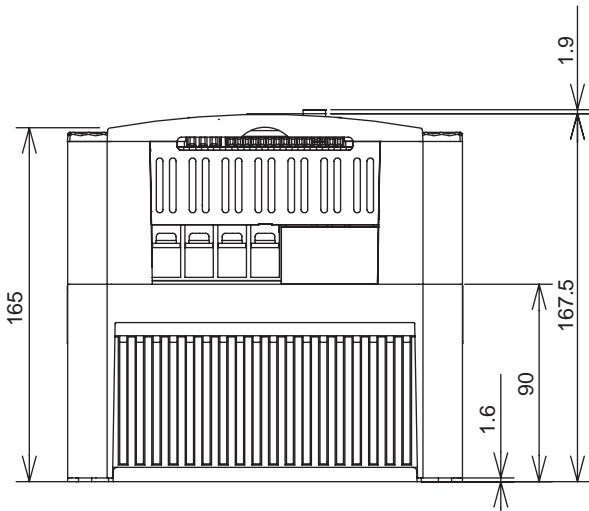
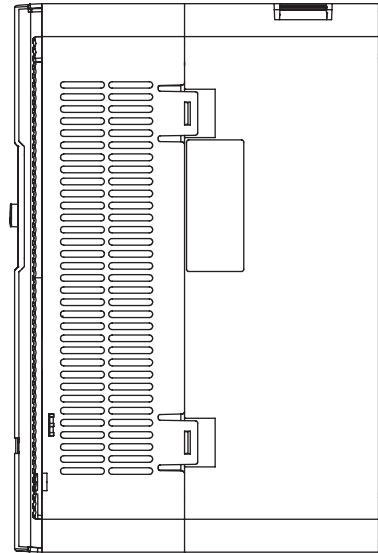
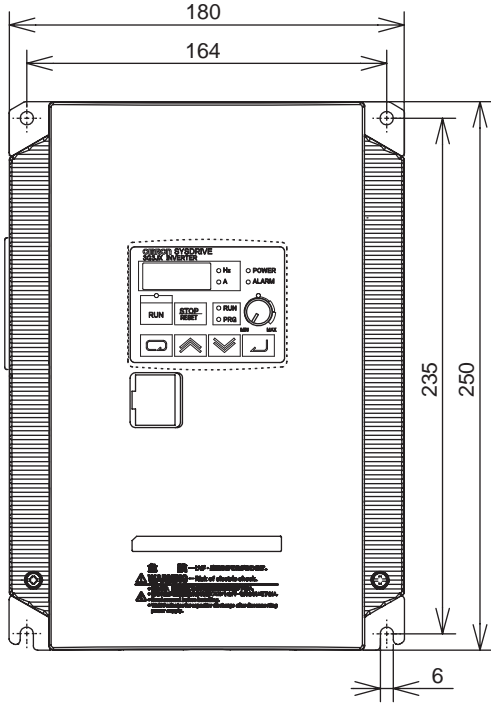

7

Specifications

7-4 Options

EMC-compatible Noise Filter (AX-FIJ□□□□-RE)

■Dimensional Drawing

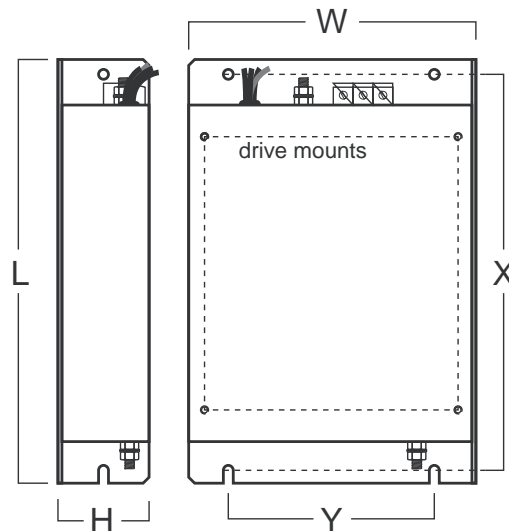

■Specifications

Power supply	Applied inverter	Filter reference	Rated current	Max. Rated Volt	Leakage current Nom/Max	External dimensions L x W x H (mm)	Mount dimensions X x Y (mm)	Fixing	W (Kg)
3-phase 200VAC	3G3JX-A2002	AX-FIJ2006-RE	6	250V	-	193 x 81 x 50	183 x 57	M4	1
	3G3JX-A2004								
	3G3JX-A2007								
	3G3JX-A2015	AX-FIJ2020-RE	20	250V	-	226 x 112 x 47	216 x 88	M4	1.3
	3G3JX-A2022								
	3G3JX-A2037								
	3G3JX-A2055	AX-FIJ2040-RE	40	250V	-	289 x 182 x 55	279 x 150	M5	2.3
3G3JX-A2075									
3-phase 400VAC	3G3JX-A4004	AX-FIJ3005-RE	5A	480V	0.3/40mA	226 x 112 x 45	216 x 88	M4	0.9
	3G3JX-A4007								
	3G3JX-A4015								
	3G3JX-A4022	AX-FIJ3011-RE	11A	480V	0.3/40mA	226 x 112 x 45	216 x 88	M4	1.1
	3G3JX-A4040								
	3G3JX-A4055	AX-FIJ3020-RE	20A	480V	0.3/40mA	289 x 182 x 50	279 x 150	M5	1.7
	3G3JX-A4075								

■ Input AC Reactor (AX-RAI□□□□□□□□)

■ Dimensional Drawing

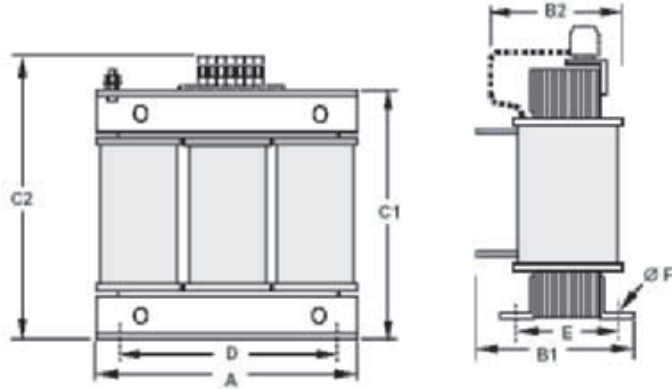

■ Specifications

Applicable Inverter 3G3JX-	Reference	Dimensions						Weight Kg	Characteristics	
		A	B2	C2	D	E	F		Inductance (mH)	Current value (A)
A2002 to A2015	AX-RAI02800080-DE	120	70	120	80	52	5.5	1.78	2.8	8.0
A2022 to A2037	AX-RAI00880175-DE	120	80	120	80	62	5.5	2.35	0.88	17.5
A2055 to A2075	AX-RAI00350335-DE	180	85	190	140	55	6	5.5	0.35	33.5
A4004 to A4015	AX-RAI07700042-DE	120	70	120	80	52	5.5	1.78	7.7	4.2
A4022 to A4040	AX-RAI03500090-DE	120	80	120	80	62	5.5	2.35	3.5	9.0
A4055 to A4075	AX-RAI01300170-DE	120	80	120	80	62	5.5	2.50	1.3	17.0

DC Reactor (AX-RC□□□□□□□□)

■ Dimensional Drawing

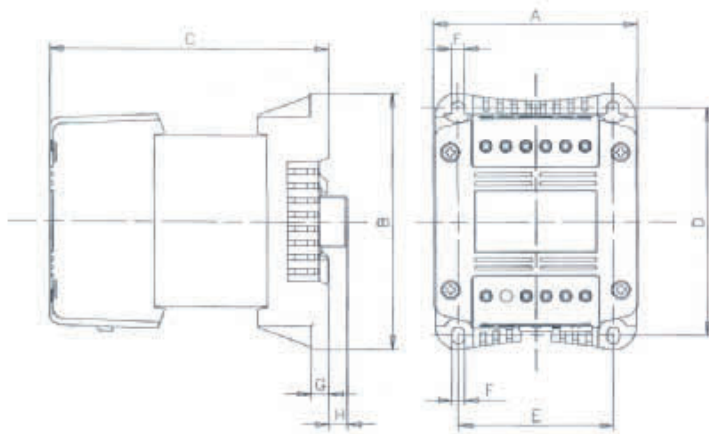

■ Specifications

Voltage	Max. applicable motor output kW	Reference	Dimensions								Characteristics		Weight kg
			A	B	C	D	E	F	G	H	Inductance (mH)	Current (A)	
200 V	0.2	AX-RC21400016-DE	84	113	96	101	66	5	7.5	2	21.4	1.6	1.22
	0.4	AX-RC10700032-DE			107						10.7	3.2	
	0.7	AX-RC06750061-DE			105						6.75	6.1	
	1.5	AX-RC03510093-DE	108	135	105	120	82	6.5	9.5	9.5	3.51	9.3	1.60
	2.2	AX-RC02510138-DE			116						2.51	13.8	
	3.7	AX-RC01600223-DE	120	152	136	135	94	7	9.5	-	1.60	22.3	3.20
	5.5	AX-RC01110309-DE	146	1.11	30.9						5.20		
7.5	AX-RC00840437-DE	146	0.84	43.7	6.00								
400 V	0.4	AX-RC43000020-DE	84	113	96	101	66	5	7.5	2	43.0	2.0	1.22
	0.7	AX-RC27000030-DE			107						27.0	3.0	
	1.5	AX-RC14000047-DE			105						14.0	4.7	1.60
	2.2	AX-RC10100069-DE	116	10.1	6.9	1.95							
	4.0	AX-RC06400116-DE	108	135	133	120	82	6.5	9.5	9.5	6.40	11.6	3.70
	5.5	AX-RC04410167-DE	146	4.41	16.7						5.20		
	7.5	AX-RC03350219-DE	146	3.35	21.9						6.00		

Output AC Reactor (AX-RAO□□□□□□□□)

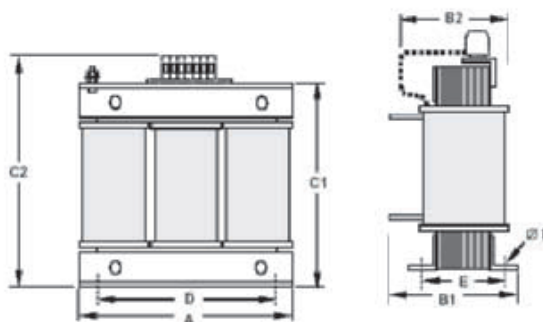

Applicable Inverter 3G3JX-	Reference	Dimensions						Weight Kg	Characteristics	
		A	B2	C2	D	E	F		Inductance (mH)	Current (A)
A2/B002 to A2/B004	AX-RAO11500026-DE	120	70	120	80	52	5.5	1.78	11.50	2.6
A2/B007	AX-RAO07600042-DE	120	70	120	80	52	5.5	1.78	7.60	4.2
A2/B015	AX-RAO04100075-DE	120	80	120	80	62	5.5	2.35	4.10	7.5
A2/B022	AX-RAO03000105-DE	120	80	120	80	62	5.5	2.35	3.00	10.5
A2037	AX-RAO01830180-DE	180	85	190	140	55	6	5.5	1.83	16.0
A2055	AX-RAO01150220-DE	180	85	190	140	55	6	5.5	1.15	22.0
A2075	AX-RAO00950320-DE	180	85	205	140	55	6	6.5	0.95	32.0
A4004 to A4015	AX-RAO16300038-DE	120	70	120	80	52	5.5	1.78	16.30	3.8
A4022	AX-RAO11800053-DE	120	80	120	80	52	5.5	2.35	11.80	5.3
A4040	AX-RAO07300080-DE	120	80	120	80	62	5.5	2.35	7.30	8.0
A4055	AX-RAO04600110-DE	180	85	190	140	55	6	5.5	4.60	11.0
A4075	AX-RAO03600160-DE	180	85	205	140	55	6	6.5	3.60	16.0

Output choke (AX-FEM□□□□-RE)

Dimensional Drawing

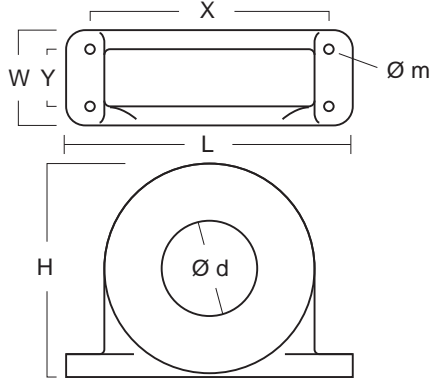

Specifications

Reference	D diameter	Motor KW	Dimensions						Weight Kg
			L	W	H	X	Y	m	
AX-FEM2102-RE	21	< 2.2	85	22	46	70	-	5	0.1
AX-FEM2515-RE	25	< 15	105	25	62	90	-	5	0.2

7

Digital Operator (3G3AX-OP01)

Specifications

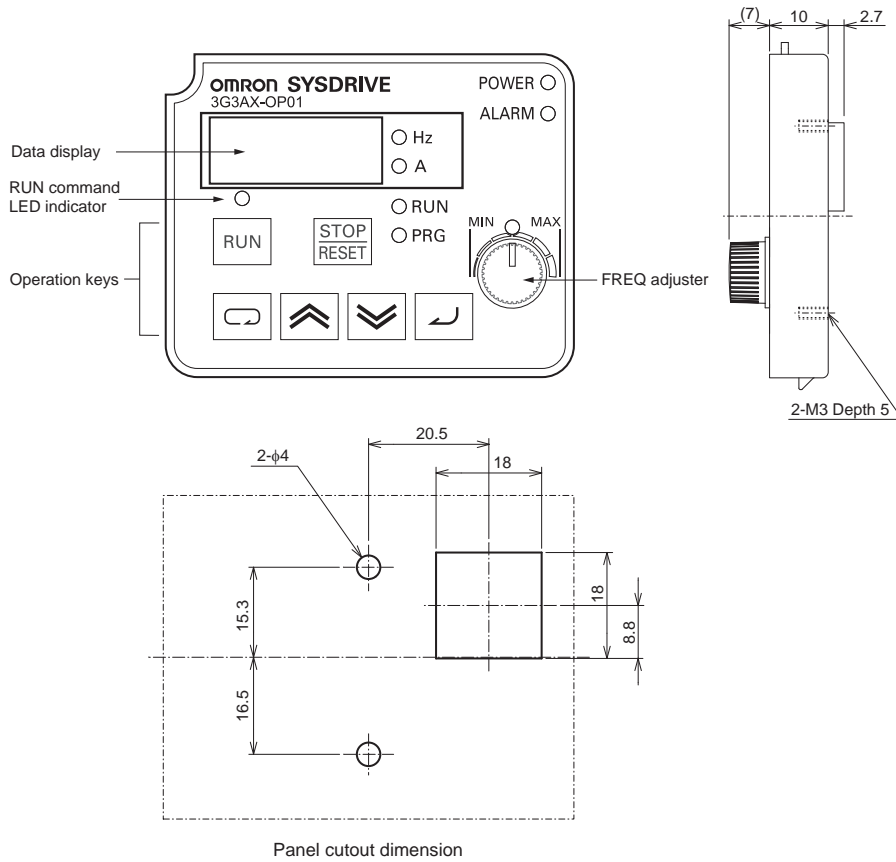

External dimensions	Height (55 mm) × Width (70 mm) × Depth (10 mm)
---------------------	--

Appendix

Appendix-1	Parameter List.....	App-2
Appendix-2	Product Life Curve.....	App-18

Appendix-1 Parameter List

Monitor Mode (d□□□) / Basic Function Mode (F□□□)

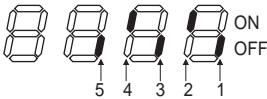
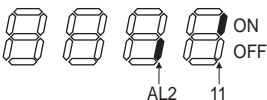
Parameter No.	Name	Monitor or data range (Digital Operator)	Default setting	Changes during operation	Unit	Set value
d001	Output frequency monitor	0.0 to 400.0	—	—	Hz	
d002	Output current monitor	0.0 to 999.9	—	—	A	
d003	Rotation direction monitor	F: Forward o: Stop r: Reverse	—	—	—	
d004	PID feedback value monitor	0.00 to 99.99 100.0 to 999.9 1000. to 9999. (Enabled when the PID function is selected)	—	—	—	
d005	Multi-function input monitor	 <p>Example: Terminal 4, 2: ON Terminal 5, 3, 1: OFF</p>	—	—	—	
d006	Multi-function output monitor	 <p>Example: Terminal 11: ON Terminal AL2: OFF</p>	—	—	—	
d007	Output frequency monitor (after conversion)	0.00 to 99.99 100.0 to 999.9 1000. to 9999. 1000 to 3996 (10000 to 39960) (Output frequency × Conversion factor of b086)	—	—	—	
d013	Output voltage monitor	0. to 600.	—	—	V	
d016	Total RUN Time	0. to 9999. 1000 to 9999 ┌100 to ┌999[h]	—	—	h	
d017	Power ON time monitor	0. to 9999. 1000 to 9999 ┌100 to ┌999[h]	—	—	h	
d018	Fin temperature monitor	0.0 to 200.0	—	—	°C	
d080	Fault frequency monitor	0. to 9999.	—	—	—	
d081	Fault monitor 1 (Latest)	Error code (condition of occurrence) → Output frequency [Hz] → Output current [A] → Internal DC voltage [V] → RUN time [h] → ON time [h]	—	—	—	
d082	Fault monitor 2					
d083	Fault monitor 3					

Parameter No.	Name	Monitor or data range (Digital Operator)	Default setting	Changes during operation	Unit	Set value
d102	DC voltage monitor	0.0 to 999.9	—	—	V	
d104	Electronic thermal monitor	0.0 to 100.0	—	—	%	
F001	Output frequency setting/monitor	Starting frequency to 1st or 2nd max. frequency	—	Yes	Hz	
F002	Acceleration time 1	0.01 to 99.99 100.0 to 999.9 1000. to 3000.	10.0	Yes	s	
F202	*2nd acceleration time 1	0.01 to 99.99 100.0 to 999.9 1000. to 3000.	10.0	Yes	s	
F003	Deceleration time 1	0.01 to 99.99 100.0 to 999.9 1000. to 3000.	10.0	Yes	s	
F203	*2nd deceleration time 1	0.01 to 99.99 100.0 to 999.9 1000. to 3000.	10.0	Yes	s	
F004	Operator rotation direction selection	00: Forward 01: Reverse	00	No	—	

* 2nd function is displayed when SET(08) is allocated to one of from C001 to C005.

Extended function mode

Parameter No.	Function name	Monitor or data range (Digital Operator)	Default setting	Changes during operation	Unit	Set value
Basic setting	A001	Frequency reference selection	00: Digital Operator (FREQ adjuster) 01: Terminal 02: Digital Operator (F001)	01	No	—
	A201	*2nd frequency reference selection	03: ModBus communication 10: Frequency operation result	01	No	—
	A002	RUN command selection	01: Terminal 02: Digital Operator	01	No	—
	A202	*2nd RUN command selection	03: ModBus communication	01	No	—
	A003	Base frequency	30. to Max. frequency [A004]	50.	No	Hz
	A203	*2nd base frequency	30. to Max. frequency [A204]	50.		
	A004	Maximum frequency	30. to 400.	50.	No	Hz
	A204	*2nd maximum frequency		50.		

* 2nd control is displayed when SET (08) is allocated to one of from C001 to C005.

Appendix-1 Parameter List

Parameter No.	Function name	Monitor or data range (Digital Operator)	Default setting	Changes during operation	Unit	Set value
Analog input	A005	O/OI selection	02: Switches between O/FREQ adjuster via terminal AT 03: Switches between OI/FREQ adjuster via terminal AT 04: O input only 05: OI input only	02	No	—
	A011	O start frequency	0.0 to Max. frequency	0.0	No	Hz
	A012	O end frequency	0.0 to Max. frequency	0.0	No	Hz
	A013	O start ratio	0. to 100.	0.	No	%
	A014	O end ratio	0. to 100.	100.	No	%
	A015	O start selection	00: External start frequency (A011 set value) 01: 0 Hz	01	No	—
	A016	O, OI sampling	1. to 17.	8.	No	—
Multi-step speed, Jogging	A020	Multi-step speed reference 0	0.0/Starting frequency to Max. frequency	6.0	Yes	Hz
	A220	*2nd multi-step speed reference 0	0.0/Starting frequency to 2nd max. frequency	6.0	Yes	Hz

* 2nd control is displayed when SET (08) is allocated to one of from C001 to C005.

Appendix-1 Parameter List

Parameter No.	Function name	Monitor or data range (Digital Operator)	Default setting	Changes during operation	Unit	Set value	
Multi-step speed, Jogging	A021	Multi-step speed reference 1	0.0	Yes	Hz		
	A022	Multi-step speed reference 2	0.0				
	A023	Multi-step speed reference 3	0.0				
	A024	Multi-step speed reference 4	0.0				
	A025	Multi-step speed reference 5	0.0				
	A026	Multi-step speed reference 6	0.0				
	A027	Multi-step speed reference 7	0.0				
	A028	Multi-step speed reference 8	0.0/Starting frequency to Max. frequency				0.0
	A029	Multi-step speed reference 9	0.0				
	A030	Multi-step speed reference 10	0.0				
	A031	Multi-step speed reference 11	0.0				
	A032	Multi-step speed reference 12	0.0				
	A033	Multi-step speed reference 13	0.0				
	A034	Multi-step speed reference 14	0.0				
	A035	Multi-step speed reference 15	0.0				
	A038	Jogging frequency	0.00/Starting frequency to 9.99				6.00
A039	Jogging stop selection	00: Free-run stop 01: Deceleration stop 02: DC injection braking stop	00	No	—		

* 2nd control is displayed when SET (08) is allocated to one of from C001 to C005.

Appendix-1 Parameter List

Parameter No.	Function name	Monitor or data range (Digital Operator)	Default setting	Changes during operation	Unit	Set value
Characteristics, Torque boost	A041	Torque boost selection	00: Manual torque boost only 01: Automatic (simple) torque boost	00	No	-
	A241	*2nd torque boost selection		00		
	A042	Manual torque boost voltage	0.0 to 20.0	1.8	Yes	%
	A242	*2nd manual torque boost voltage		0.0		
	A043	Manual torque boost frequency	0.0 to 50.0	10	Yes	%
	A243	*2nd manual torque boost frequency		0.0		
	A044	V/f characteristics selection	00: Constant torque characteristics (VC) 01: Reduced torque characteristics (VP 1.7th power) 06: Special reduced torque characteristics (Special VP)	00	No	-
	A244	*2nd V/f characteristics selection		00		
	A045	Output voltage gain	20. to 100.	100.	Yes	%
	A245	*2nd output voltage gain		100.		
DC injection braking	A051	DC injection braking selection	00: Disabled 01: Enabled 02: Frequency control [A052 set value]	00	No	—
	A052	DC injection braking frequency	0.0 to 60.0	0.5	No	Hz
	A053	DC injection braking delay time	0.0 to 5.0	0.0	No	s
	A054	DC injection braking power	0. to 100.	50	No	%
	A055	DC injection braking time	0.0 to 60.0	0.5	No	s
	A056	DC injection braking method selection	00: Edge operation 01: Level operation	01	No	—

* 2nd control is displayed when SET (08) is allocated to one of from C001 to C005.

Appendix-1 Parameter List

Parameter No.	Function name	Monitor or data range (Digital Operator)	Default setting	Changes during operation	Unit	Set value
Upper/Lower limit, Jump	A061	Frequency upper limit	0.0/Frequency lower limit to Max. frequency	0.0	No	Hz
	A261	*2nd frequency upper limit	0.0/Frequency lower limit to 2nd Max. frequency	0.0		
	A062	Frequency lower limit	0.0/Starting frequency to Frequency upper limit	0.0	No	Hz
	A262	*2nd frequency lower limit	0.0/Starting frequency to 2nd frequency upper limit	0.0		
	A063	Jump frequency 1	Jump frequency: 0.0 to 400.0 Jump frequency width: 0.0 to 10.0	0.0	No	Hz
	A064	Jump frequency width 1		0.5		
	A065	Jump frequency 2		0.0		
	A066	Jump frequency width 2		0.5		
	A067	Jump frequency 3		0.0		
A068	Jump frequency width 3	0.5				
PID control	A071	PID selection	00: Disabled 01: Enabled	00	No	—
	A072	PID P gain	0.2 to 5.0	1.0	Yes	—
	A073	PID I gain	0.0 to 150.0	1.0	Yes	s
	A074	PID D gain	0.00 to 100.0	0.0	Yes	s
	A075	PID scale	0.01 to 99.99	1.00	No	Time
	A076	PID feedback selection	00: OI 01: O 02: RS485 communication 10: Operation function output	00	No	—
	A077	Reverse PID function	00: OFF (Deviation = Target value - Feedback value) 01: ON (Deviation = Feedback value - Target value)	00	No	—
	A078	PID output limit function	0.00 to 100.0	0.0	No	%
AVR	A081	AVR selection	00: Always ON 01: Always OFF 02: OFF during deceleration	02	No	—
	A082	AVR voltage selection	200-V class: 200/215/220/230/240 400-V class: 380/400/415/440/460/480	200/400	No	V

* 2nd control is displayed when SET (08) is allocated to one of from C001 to C005.

Appendix-1 Parameter List

Parameter No.	Function name	Monitor or data range (Digital Operator)	Default setting	Changes during operation	Unit	Set value	
RUN mode, Acceleration/Deceleration functions	A085	RUN mode selection	00: Normal operation 01: Energy-saving operation	00	No	-	
	A086	Energy-saving response/accuracy adjustment	0 to 100	50	No	%	
	A092	Acceleration time 2	0.01 to 99.99 100.0 to 999.9 1000. to 3000.	10.00	Yes	s	
	A292	*2nd acceleration time 2		10.00			
	A093	Deceleration time 2	0.01 to 99.99 100.0 to 999.9 1000. to 3000.	10.00	Yes	s	
	A293	*2nd deceleration time 2		10.00			
	A094	2-step acceleration/deceleration selection	00: Switched via multi-function input 09 (2CH) 01: Switched by setting	00	No	—	
	A294	*2nd 2-step acceleration/deceleration selection		00			
	A095	2-step acceleration frequency	0.0 to 400.0	0.0	No	Hz	
	A295	*2nd 2-step acceleration frequency		0.0			
	A096	2-step deceleration frequency	0.0 to 400.0	0.0	No	Hz	
	A296	*2nd 2-step deceleration frequency		0.0			
	A097	Acceleration pattern selection	00: Line 01: S-shape curve	00	No	—	
	A098	Deceleration pattern selection	00: Line 01: S-shape curve	00	No	—	

* 2nd control is displayed when SET (08) is allocated to one of from C001 to C005.

Appendix-1 Parameter List

Parameter No.	Function name	Monitor or data range (Digital Operator)	Default setting	Changes during operation	Unit	Set value
External frequency adjustment	A101	OI start frequency	0.0 to 400.0	0.0	No	Hz
	A102	OI end frequency	0.0 to 400.0	0.0	No	Hz
	A103	OI start ratio	0. to 100.	0.	No	%
	A104	OI end ratio	0. to 100.	100.	No	%
	A105	OI start selection	00: Use OI start frequency [A101] 01: 0 Hz start	01	No	—
Operation frequency	A141	Operation frequency input A setting	00: Digital Operator (F001) 01: Digital Operator (FREQ adjuster) 02: Input O	01	No	—
	A142	Operation frequency input B setting	03: Input OI 04: RS485 communication	02	No	—
	A143	Operator selection	00: Addition (A + B) 01: Subtraction (A - B) 02: Multiplication (A × B)	00	No	—
Frequency addition	A145	Frequency addition amount	0.0 to 400.0	0.0	Yes	Hz
	A146	Frequency addition direction	00: Adds A145 value to output frequency 01: Subtract A145 value from output frequency	00	No	—
VR adjustment	A151	VR start frequency	0.0 to 400.0	0.0	No	Hz
	A152	VR end frequency	0.0 to 400.0	0.0	No	Hz
	A153	VR start ratio	0. to 100.	0.	No	%
	A154	VR end ratio	0. to 100.	100.	No	%
	A155	VR start selection	00: Use VR start frequency [A151] 01: 0 Hz start	01	No	—

* 2nd control is displayed when SET (08) is allocated to one of from C001 to C005.

Appendix-1 Parameter List

Parameter No.	Function name	Monitor or data range (Digital Operator)	Default setting	Changes during operation	Unit	Set value
Restart during momentary power interruption	b001	Retry selection	00: Alarm 01: 0 Hz start 02: Frequency Matching start 03: Trip after Frequency Matching deceleration stop	00	No	—
	b002	Allowable momentary power interruption time	0.3 to 25.0	1.0	No	s
	b003	Retry wait time	0.3 to 100.0	1.0	No	s
	b004	Momentary power interruption/ undervoltage trip during stop selection	00: Disabled 01: Enabled	00	No	—
	b005	Momentary power interruption retry time selection	00: 16 times 01: No limit	00	No	—
	b011	Starting frequency at Active Frequency Matching restart	00: Frequency at interruption 01: Max. frequency 02: Set frequency	00	No	—
Electronic thermal	b012	Electronic thermal level	0.2 × Rated current to 1.0 × Rated current	Rated current	No	A
	b212	*2nd electronic thermal level		Rated current		
	b013	Electronic thermal characteristics selection	00: Reduced torque characteristics 1 01: Constant torque characteristics 02: Reduced torque characteristics 2	01	No	—
	b213	*2nd electronic thermal characteristics selection		01		

* 2nd control is displayed when SET (08) is allocated to one of from C001 to C005.

Appendix-1 Parameter List

Parameter No.	Function name	Monitor or data range (Digital Operator)	Default setting	Changes during operation	Unit	Set value
Overload limit	b021	Overload limit selection	00: Disabled 01: Enabled in acceleration/constant speed operation	00	No	—
	b221	*2nd overload limit selection	02: Enabled in constant speed operation	00		
	b022	Overload limit level	0.1 × Rated current to 1.5 × Rated current	1.5 × Rated current	No	A
	b222	*2nd overload limit level		1.5 × Rated current		
	b023	Overload limit parameter	0.1 to 3000.0	1.0	No	s
	b223	*2nd overload limit parameter		1.0		
	b028	Overload limit source selection	00: b022, b222 set values 01: Input terminal O	00	No	—
	b228	*2nd overload limit source selection		00		
Active Frequency Matching	b029	Deceleration rate constant at Active Frequency Matching restart	0.1 to 3000.0	0.5	No	s
	b030	Active Frequency Matching restart level	0.2 × Rated current to 2.0 × Rated current	Rated current	No	A
Lock	b031	Soft lock selection	00: Data other than b031 cannot be changed when terminal SFT is ON. 01: Data other than b031 and the specified frequency parameter cannot be changed when terminal SFT is ON. 02: Data other than b031 cannot be changed. 03: Data other than b031 and the specified frequency parameter cannot be changed. 10: Data other than parameters changeable during operation cannot be changed.	01	No	—

* 2nd control is displayed when SET (08) is allocated to one of from C001 to C005.

Appendix-1 Parameter List

Parameter No.	Function name	Monitor or data range (Digital Operator)	Default setting	Changes during operation	Unit	Set value	
Non-stop function at momentary power interruption	b050	Selection of non-stop function at momentary power interruption 00: Disabled 01: Enabled (Stop) 02: Enabled (Restart)	00	No			
	b051	Starting voltage of non-stop function at momentary power interruption	0.0 to 1000.	No	V		
	b052	Stop deceleration level of non-stop function at momentary power interruption	0.0 to 1000.	0.0	No	V	
	b053	Deceleration time of non-stop function at momentary power interruption	0.01 to 99.99 100.0 to 999.9 1000 to 3000	1.0	No	s	
	b054	Deceleration starting width of non-stop function at momentary power interruption	0.0 to 10.0	0.0	No	Hz	
Others	b055	Overvoltage protection proportional gain during deceleration	0.2 to 5.0	0.2	Yes	—	
	b056	Overvoltage protection integral time during deceleration	0.0 to 150.0	0.2	Yes	s	
	b080	AM adjustment	0. to 255. (Shared with C086 for AM offset adjustment)	100.	Yes	—	
	b082	Starting frequency	0.5 to 9.9	0.5	No	Hz	
	b083	Carrier frequency	2.0 to 12.0	3.0	No	kHz	
Initialization	b084	Initialization selection 00: Clears the trip monitor 01: Initializes data 02: Clears the trip monitor and initializes data	00	No	—		
	b085	Initialization parameter selection 01 * Do not change.	01	No	—		

* 2nd control is displayed when SET (08) is allocated to one of from C001 to C005.

Parameter No.	Function name	Monitor or data range (Digital Operator)	Default setting	Changes during operation	Unit	Set value
Others	b086	Frequency conversion coefficient	0.1 to 99.9	1.0	Yes	—
	b087	STOP key selection	00: Enabled 01: Disabled	00	No	—
	b088	Free-run stop selection	00: 0 Hz start 01: Active Frequency Matching restart	00	No	—
	b089	Monitor display selection	01: Output frequency monitor 02: Output current monitor 03: Rotation direction monitor 04: PID feedback value monitor 05: Multi-function input monitor 06: Multi-function output monitor 07: Frequency conversion monitor	01	Yes	—
	b091	Stop selection	00: Deceleration → Stop 01: Free-run stop	00	No	—
	b092	Cooling fan control	00: Always ON 01: ON during RUN 02: Depends on the fin temperature	01	No	—
	b130	Overvoltage LAD stop function	00: Disabled 01: Enabled	00	No	—
	b131	Overvoltage LAD stop function level setting	200-V class: 330. to 395. 400-V class: 660. to 790.	380/ 760	Yes	V
	b133	Overvoltage protection function selection during deceleration	00: Disabled 01: Enabled	00	No	—
	b134	Overvoltage protection level setting during deceleration	200-V class: 330. to 395. 400-V class: 660. to 790.	380/ 760	No	V
	b140	Overcurrent suppression function	00: Disabled 01: Enabled	01	No	—
	b150	Automatic carrier reduction	00: Disabled 01: Enabled	00	No	—
	b151	Ready function selection	00: Disabled 01: Enabled	00	No	—

* 2nd control is displayed when SET (08) is allocated to one of from C001 to C005.

Appendix-1 Parameter List

Parameter No.	Function name	Monitor or data range (Digital Operator)	Default setting	Changes during operation	Unit	Set value	
Multi-function input terminals	C001	Multi-function input 1 selection	00: FW (forward) 01: RV (reverse)	No	—		
	C201	*2nd multi-function input 1 selection	02: CF1 (multi-step speed setting binary 1) 03: CF2 (multi-step speed setting binary 2) 04: CF3 (multi-step speed setting binary 3) 05: CF4 (multi-step speed setting binary 4) 06: JG (jogging)				00
	C002	Multi-function input 2 selection	07: DB (external DC injection braking) 08: SET (2nd control) 09: 2CH (2-step acceleration/deceleration)				01
	C202	*2nd multi-function input 2 selection	11: FRS (free-run stop) 12: EXT (external trip) 13: USP (USP function) 15: SFT (soft lock)				01
	C003	Multi-function input 3 selection	16: AT (analog input switching) 18: RS (reset) 19: PTC (thermistor input)				18
	C203	*2nd multi-function input 3 selection	20: STA (3-wire start) 21: STP (3-wire stop) 22: F/R (3-wire forward/reverse) 23: PID (PID enabled/disabled) 24: PIDC (PID integral reset)				18
	C004	Multi-function input 4 selection	27: UP (UP/DWN function accelerated) 28: DWN (UP/DWN function decelerated) 29: UDC (UP/DWN function data clear)				12
	C204	*2nd multi-function input 4 selection	31: OPE (forced operator) 50: ADD (frequency addition) 51: F-TM (forced terminal block)				12
	C005	Multi-function input 5 selection	52: RDY (ready function) 53: SP-SET (special 2nd function) 64: EMR (emergency shutoff *1) 255: No function				02
	C205	*2nd multi-function input 5 selection	*1. The EMR is set forcibly with switch S8, not with parameters.				02
Multi-function operation terminals	C011	Multi-function input 1 operation selection	00: NO 01: NC	No	—		
	C012	Multi-function input 2 operation selection					00
	C013	Multi-function input 3 operation selection					00
	C014	Multi-function input 4 operation selection					00
	C015	Multi-function input 5 operation selection					00

* 2nd control is displayed when SET (08) is allocated to one of from C001 to C005.

Appendix-1 Parameter List

Parameter No.	Function name	Monitor or data range (Digital Operator)	Default setting	Changes during operation	Unit	Set value	
Multi-function output setting	C021	Multi-function output terminal 11 selection	00	No	—		
	C026	Relay output (AL2, AL1) function selection					
	C028	AM selection	00	No	—		
	C031	Multi-function output terminal 11 contact selection	00	No	—		
	C036	Relay output (AL2, AL1) contact selection					
	C038	Light load signal output mode	01	No	—		
	C039	Light load detection level	0.0 to 2.0 × Rated current (0.0 setting: Function disable)	Rated current	No	—	
Level output status setting	C041	Overload warning level	Rated current	No	A		
	C241	*2nd overload warning level	Rated current				
	C042	Arrival frequency during acceleration	0.0 to 400.0	0.0	No	Hz	
	C043	Arrival frequency during deceleration	0.0 to 400.0	0.0	No	Hz	
	C044	PID deviation excessive level	0.0 to 100.0	3.0	No	%	
	C052	PID FB upper limit	0.0 to 100.0	100	No	%	
	C053	PID FB lower limit		0.0			

* 2nd control is displayed when SET (08) is allocated to one of from C001 to C005.

Appendix-1 Parameter List

Parameter No.	Function name	Monitor or data range (Digital Operator)	Default setting	Changes during operation	Unit	Set value
Communication function adjustment	C070	Operator/ModBus selection	02: Digital Operator 03: ModBus	02	No	—
	C071	Communication speed selection (Baud rate selection)	04: 4800 bps 05: 9600 bps 06: 19200 bps	06	No	—
	C072	Communication station No. selection	1. to 32.	1.	No	—
	C074	Communication parity selection	00: No parity 01: Even 02: Odd	00	No	—
	C075	Communication stop bit selection	1: 1-bit 2: 2-bit	1	No	—
	C076	Communication error selection	00: Trip 01: Trip after deceleration stop 02: Ignore 03: Free run 04: Deceleration stop	02	No	—
	C077	Communication error timeout	0.00 to 99.99	0.00	No	s
	C078	Communication wait time	0. to 1000.	0.	No	ms
Various adjustment	C081	O adjustment	0.0 to 200.0	100.0	Yes	%
	C082	OI adjustment	0.0 to 200.0	100.0	Yes	%

* 2nd control is displayed when SET (08) is allocated to one of from C001 to C005.

Appendix-1 Parameter List

Parameter No.	Function name	Monitor or data range (Digital Operator)	Default setting	Changes during operation	Unit	Set value
Others	C086	AM offset adjustment	0.0 to 10.0	0.0	Yes	V
	C091	Not used	Use "00". *Do not change.	00	—	—
	C101	UP/DWN selection	00: Do not store the frequency data 01: Store the frequency data	00	No	—
	C102	Reset selection	00: Trip reset at power-on 01: Trip reset when the power is OFF 02: Enabled only during trip (Reset when the power is ON.)	00	No	—
	C141	Logic operation function A input	00: RUN (signal during RUN) 01: FA1 (constant speed arrival signal) 02: FA2 (over set frequency arrival signal) 03: OL (overload warning) 04: OD (excessive PID deviation) 05: AL (alarm output)	00	No	—
	C142	Logic operation function B input	06: Dc (disconnection detected) 07: FBV (PID FB status output) 08: NDc (network error) 10: ODc (Do not use.) 43: LOC (light load detection signal)	01	No	—
	C143	Logic operator selection	00: AND 01: OR 02: XOR	00	No	—
	C144	Output terminal 11 ON delay	0.0 to 100.0	0.0	No	s
	C145	Output terminal 11 OFF delay	0.0 to 100.0	0.0	No	s
	C148	Relay output ON delay	0.0 to 100.0	0.0	No	s
	C149	Relay output OFF delay	0.0 to 100.0	0.0	No	s
Control parameter	H003	Motor capacity selection	200-V class 0.2/0.4/0.75/1.5/2.2/3.7/5.5/7.5	Factory default	No	kW
	H203	*2nd motor capacity selection	400-V class 0.4/0.75/1.5/2.2/3.7/5.5/7.5	Factory default		
	H004	Motor pole number selection	2 4 6 8	4	No	Pole
	H204	*2nd motor pole number selection	4			
	H006	Stabilization parameter	0. to 255.	100	Yes	%
	H206	*2nd stabilization parameter		100	Yes	%

* 2nd control is displayed when SET (08) is allocated to one of from C001 to C005.

Appendix-2 Product Life Curve

Life of the Inverter smoothing capacitor

Ambient temperature refers to the surrounding temperature of the Inverter. The following diagram shows the product life curve.

The smoothing capacitor, which will deteriorate due to the chemical reaction caused by parts temperatures, should normally be replaced once every 5 years. However, if the ambient temperature is high, or the Inverter is used with a current exceeding the rated current, for example, under overload conditions, its life will be significantly shortened.

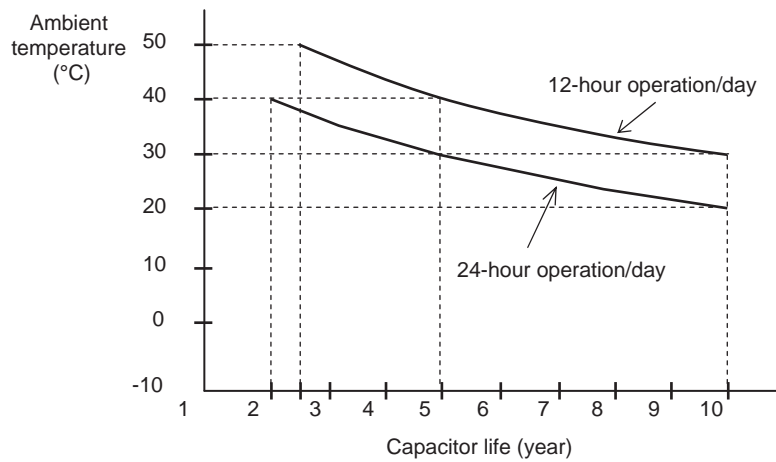

Note: Ambient temperature refers to the surrounding (atmospheric) temperature of the Inverter, or the temperature inside if the Inverter is encased or installed in an enclosure.

INDEX

Index

Numerics

2CH (2-step acceleration/deceleration)	4-27, 4-49
2nd control function and special 2nd function	4-47
2-step acceleration/deceleration.	4-27, 4-49
3-wire input.	4-52

A

acceleration time	4-6
acceleration time 2	4-27
acceleration/deceleration pattern	4-28
ADD	4-29
AL	4-57
alarm output	4-57
allowable momentary power interruption time	4-30
AM	4-62
analog input	4-10
analog input disconnection detection	4-58
analog output	4-62
automatic carrier frequency reduction	4-43
automatic energy-saving operation	4-26
AVR	4-26
AVR voltage selection	4-26

B

base frequency.	4-9
-------------------------	-----

C

carrier frequency.	4-40
CF1 to CF4.	4-47
communication function (ModBus)	4-65
constant torque characteristics (VC)	4-15
control method	4-15
cooling fan control	4-43

D

DB.	4-18, 4-47
Dc.	4-58
DC injection braking	
external DC injection braking	4-18
internal DC injection braking	4-19
set frequency operation	4-19
deceleration time	4-6
deceleration time 2	4-27
DWN.	4-53

E

electronic thermal.	4-32
emergency shutoff input function	4-46

end frequency	4-11
EXT	4-49
external trip	4-49

F

F/R.	4-52
FA1	4-57
FA2	4-57
fault frequency monitor	4-4
fault monitor.	4-5
FBV	4-24
fin temperature monitor	4-4
forced operator	4-54
forced terminal block	4-54
frequency addition (ADD)	4-54
frequency arrival	4-56
frequency arrival signal	4-56
frequency conversion coefficient	4-41
frequency conversion monitor	4-42
frequency jump	4-21
frequency limit	
lower limit	4-20
upper limit	4-20
frequency pull-in	4-30
frequency reference selection	4-8
FRS	4-42
F-TM	4-54
FV/FI	4-62

I

initialization	4-41
input terminal NC/NO	4-44

J

JG	4-14
jogging operation.	4-14, 4-47

L

light load detection.	4-60
LOC	4-60
LOG	4-59
logic operation output (LOG)	4-59

M

main unit monitor display selection	4-42
maximum frequency	4-9
momentary power interruption non-stop function	4-36
momentary power interruption retry.	4-30
momentary power interruption/undervoltage trip during	

stop selection 4-30
multi-function input 4-44
multi-function input monitor 4-3
multi-function output 4-61
multi-function output monitor 4-3
multi-function output selection 4-55
multi-step speed operation function 4-47

N

NDc 4-58

O

OD 4-23
OL 4-34
OPE 4-54
output current monitor 4-2
output frequency monitor 4-2
output frequency setting 4-6
output terminal NC/NO selection 4-61
output voltage gain 4-17
output voltage monitor 4-4
overcurrent suppression 4-43
overload limit/overload warning 4-33
overload warning 4-34
overvoltage LAD stop function 4-43

P

PID 4-22
PID feedback value monitor 4-2
PIDC 4-25
power ON time 4-4
power recovery restart prevention 4-50
PTC 4-51

R

RDY 4-43, 4-44
RDY (ready) function 4-43
reduced torque characteristics (VP) 4-15
relay output contact selection 4-61
reset 4-50
retry selection 4-30
rotation (digital operator) direction selection 4-7
rotation (RUN) direction monitor 4-2
RS 4-50
RUN 4-55
RUN command selection 4-8

S

SET 4-47

SFT 4-35
signal during RUN 4-55
sink/source logic 2-12
soft lock 4-35, 4-50
SP-SET 4-47
STA 4-52
stabilization parameter 4-63
start frequency 4-11
starting frequency 4-39
STOP key selection 4-41
stop selection 4-41
STP 4-52

T

thermistor trip function 4-51
torque boost 4-15
total RUN time 4-4

U

UDC 4-53
UP 4-53
UP/DOWN 4-53
USP 4-50

OMRON EUROPE B.V. Wegalaan 67-69, NL-2132 JD, Hoofddorp, The Netherlands.
Tel: +31 (0) 23 568 13 00 Fax: +31 (0) 23 568 13 88 industrial.omron.eu

Austria

Tel: +43 (0) 2236 377 800
industrial.omron.at

Belgium

Tel: +32 (0) 2 466 24 80
industrial.omron.be

Czech Republic

Tel: +420 234 602 602
industrial.omron.cz

Denmark

Tel: +45 43 44 00 11
industrial.omron.dk

Finland

Tel: +358 (0) 207 464 200
industrial.omron.fi

France

Tel: +33 (0) 1 56 63 70 00
industrial.omron.fr

Germany

Tel: +49 (0) 2173 6800 0
industrial.omron.de

Hungary

Tel: +36 (0) 1 399 30 50
industrial.omron.hu

Italy

Tel: +39 02 32 681
industrial.omron.it

South Africa

Tel: +27 (0) 11 579 2600
industrial.omron.eu

Netherlands

Tel: +31 (0) 23 568 11 00
industrial.omron.nl

Norway

Tel: +47 (0) 22 65 75 00
industrial.omron.no

Poland

Tel: +48 22 458 66 66
industrial.omron.pl

Portugal

Tel: +351 21 942 94 00
industrial.omron.pt

Russia

Tel: +7 495 648 94 50
industrial.omron.ru

Spain

Tel: +34 902 100 221
industrial.omron.es

Sweden

Tel: +46 (0) 8 632 35 00
industrial.omron.se

Switzerland

Tel: +41 (0) 41 748 13 13
industrial.omron.ch

Turkey

Tel: +90 212 467 30 00
industrial.omron.com.tr

United Kingdom

Tel: +44 (0) 870 752 08 61
industrial.omron.co.uk

Note: Specifications subject to change without notice.
Cat. No. I558-E2-03A

OMRON