

Data sheet | Item number: 2060-1451/998-404

THR PCB terminal block; push-button; 0.75 mm²; Pin spacing 4 mm; 1-pole;
Push-in CAGE CLAMP®; in tape-and-reel packaging; 0,75 mm²; white



www.wago.com/2060-1451/998-404



Color: ■

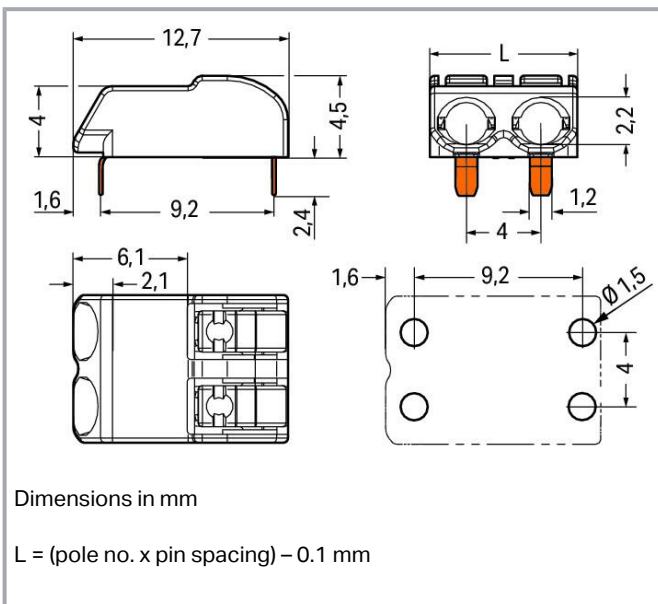
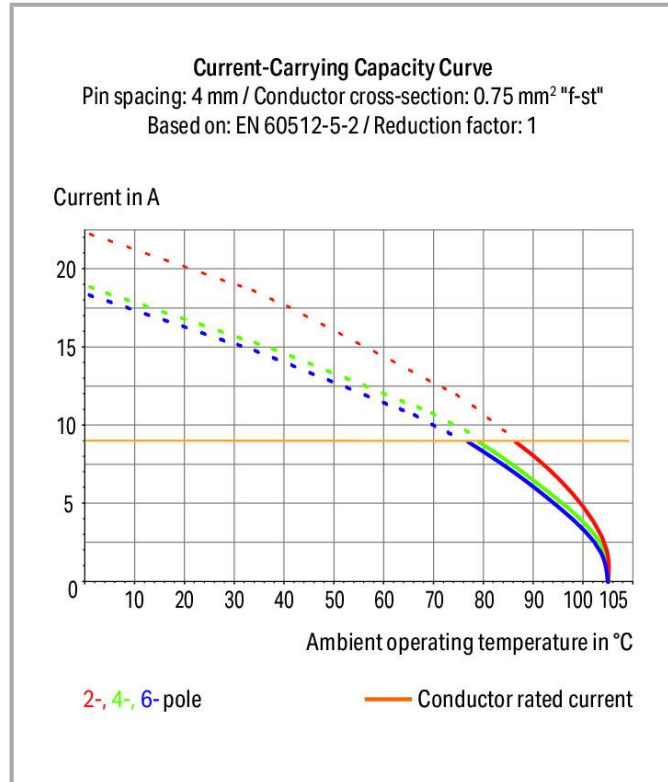

Subject to changes. Please also observe the further product documentation!

WAGO GmbH & Co. KG
Hansastr. 27
32423 Minden
Phone: +49571 887-0 | Fax: +49571 887-169
Email: info.de@wago.com | Web: www.wago.com

Do you have any questions about our products?
We are always happy to take your call at +49 (571) 887-44222.

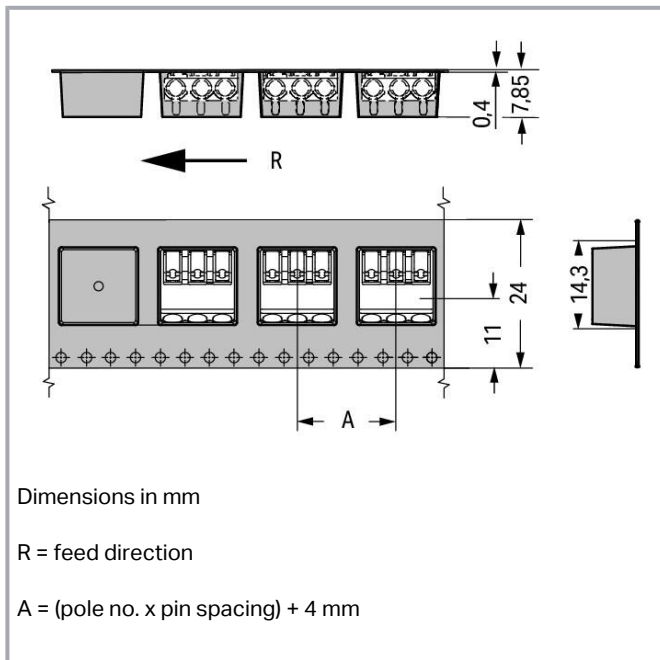

Item description

- THR PCB terminal blocks with Push-in CAGE CLAMP® connection technology and push-buttons
- Push-in termination of solid and ferruled conductors
- Convenient termination/removal of fine-stranded conductors via push-buttons
- Just 4.5 mm tall
- Available in tape-and-reel packaging for automated assembly
- Also suitable for wave soldering

Data

Notes

Note

Application notes:

Suitable for lead-free, reflow-soldering profiles per DIN EN 61760-1 and IEC 60068-2-58 up to max. 260°C peak temperature. Due to application-specific variables (component configuration and orientation, type of soldering machine, solder paste), trial runs are recommended to ensure product and process compatibility under actual manufacturing conditions.

Note

Subject to changes. Please also observe the further product documentation!



Depending on reflow soldering temperatures and times, color deviations may occur. These deviations will have no impact on functionality.

Recommendation

Recommendation for stencil:

150 µm material thickness

Stencil hole diameter identical to metal-plated PCB hole outer diameter

Electrical data

Ratings per IEC/EN

Ratings per	IEC/EN 60664-1
Nominal voltage (III/3)	63 V
Rated impulse voltage (III/3)	2.5 kV
Rated voltage (III/2)	160 V
Rated impulse voltage (III/2)	2.5 kV
Nominal voltage (II/2)	320 V
Rated surge voltage (II/2)	2.5 kV
Rated current	9 A
Legend (ratings)	(III / 2) ≙ Overvoltage category III / Pollution degree 2

Ratings per UL 1977

Rated voltage (UL 1977)	600 V
Rated current UL 1977	9 A

Connection data

Connection points	1
Total number of potentials	1
Number of connection types	1
Number of levels	1

Connection 1

Connection technology

Push-in CAGE CLAMP®

Subject to changes. Please also observe the further product documentation!

WAGO GmbH & Co. KG

Hansastr. 27

32423 Minden

Phone: +49571 887-0 | Fax: +49571 887-169

Email: info.de@wago.com | Web: www.wago.com

Do you have any questions about our products?

We are always happy to take your call at +49 (571) 887-44222.



Actuation type	Push-button
Solid conductor	0.2 ... 0.75 mm ² / 24 ... 18 AWG
Fine-stranded conductor	0.2 ... 0.75 mm ² / 24 ... 18 AWG
Fine-stranded conductor; with insulated ferrule	0.25 ... 0.34 mm ²
Fine-stranded conductor; with uninsulated ferrule	0.25 ... 0.34 mm ²
Strip length	6 ... 7 mm / 0.24 ... 0.28 inches
Conductor connection direction to PCB	0°
Pole number	1

Physical data

Pin spacing	4 mm / 0.157 inches
Width	3.9 mm / 0.154 inches
Height	6.9 mm / 0.272 inches
Height from the surface	4.5 mm / 0.177 inches
Depth	12.7 mm / 0.5 inches
Solder pin length	2.4 mm
Solder pin dimensions	1.2 x 0.75 mm
Plated through-hole diameter (THR)	1.5 ^(+0.1) mm
Reel diameter of tape-and-reel packaging	330 mm
Tape width	24 mm

Plug-in connection

Plugging without loss of pin spacing	Yes
--------------------------------------	-----

PCB contact

PCB contact	THR
Solder pin arrangement	Over the entire terminal strip (in-line)
Number of solder pins per potential	2

Material Data

Note (material data)	Information on material specifications can be found here
Color	white
Material group	I
Insulation material	Polyphthalamide (PPA GF)
Flammability class per UL94	V0

Subject to changes. Please also observe the further product documentation!



Clamping spring material	Copper alloy
Contact material	Copper alloy
Contact plating	Tin
Fire load	0.003 MJ
Weight	0.2 g
MSL gemäß J-STD 020D	1

Environmental requirements

Limit temperature range	-60 ... +105 °C
-------------------------	-----------------

Commercial data



eCl@ss 10.0	27-14-11-06
eCl@ss 9.0	27-14-11-06
ETIM 8.0	EC001284
ETIM 7.0	EC001284
PU (SPU)	10800 (1200) pcs
Packaging type	box
Country of origin	CN
GTIN	4055143331227
Customs tariff number	85369010000

Environmental Product Compliance

RoHS Compliance Status	Compliant, No Exemption
------------------------	-------------------------



Approvals / Certificates

General approvals



Logo	Approval	Additional Approval Text	Certificate name
	CCA DEKRA Certification B.V.	EN 60947	NTR NL-7724
	CCA DEKRA Certification B.V.	EN 60838	NTR NL-2168246
	CCA DEKRA Certification B.V.	EN 60947-7-4	NTR NL-7843

Subject to changes. Please also observe the further product documentation!

CCA

	cURus Underwriters Laboratories Inc.	UL 1977	E45171
	KEMA/KEUR DEKRA Certification B.V.	EN 60838	2168246.01
	KEMA/KEUR DEKRA Certification B.V.	EN 60947	71-108183
	KEMA/KEUR DEKRA Certification B.V.	EN 60998	71-109040
	KEMA/KEUR DEKRA Certification B.V.	EN 60947-7-4	71-114208

Declarations of conformity and manufacturer's declarations

Logo	Approval	Additional Approval Text	Certificate name
	EU-Declaration of Conformity WAGO GmbH & Co. KG	-	-
	UK-Declaration of Conformity WAGO GmbH & Co. KG	-	-

Optional accessories

Tool
Operating tool

Subject to changes. Please also observe the further product documentation!



Item no.: 206-860
Operating tool; for 2060 Series; multicoloured

www.wago.com/206-860







Item no.: 2060-189
Operating tool; made of insulating material; for 2060 Series; white

www.wago.com/2060-189

Ferrule

Ferrule

	Item no.: 216-132 Ferrule; Sleeve for 0.34 mm ² / AWG 24; uninsulated; electro-tin plated	www.wago.com/216-132
	Item no.: 216-131 Ferrule; Sleeve for 0.25 mm ² / AWG 24; uninsulated; electro-tin plated; silver-colored	www.wago.com/216-131
	Item no.: 216-301 Ferrule; Sleeve for 0.25 mm ² / AWG 24; insulated; electro-tin plated; yellow	www.wago.com/216-301
	Item no.: 216-302 Ferrule; Sleeve for 0.34 mm ² / 22 AWG; insulated; electro-tin plated; light turquoise	www.wago.com/216-302

Downloads

Documentation

Additional Information

Technical Section	2019 Apr 3	pdf	Download
Technical explanations		2.0 MB	
THR Soldering Process		pdf	Download
		548.2 kB	

CAD/CAE-Data

CAD data

2D/3D Models 2060-1451/998-404	URL	Download
--------------------------------	-----	----------

CAE data

ZUKEN Portal 2060-1451/998-404	URL	Download
--------------------------------	-----	----------

Environmental Product Compliance

Compliance Search

Environmental Product Compliance 2060-1451/998-404

Subject to changes. Please also observe the further product documentation!

WAGO GmbH & Co. KG
Hansastr. 27
32423 Minden
Phone: +49571 887-0 | Fax: +49571 887-169
Email: info.de@wago.com | Web: www.wago.com

Do you have any questions about our products?
We are always happy to take your call at +49 (571) 887-44222.

THR PCB terminal block; push-button; 0.75 mm²; Pin spacing 4 mm; 1-pole; Push-in CAGE CLAMP®; in tape-and-reel packaging; 0,75 mm²; white

Installation Notes

Conductor termination



Insert solid conductors via push-in termination.

Conductor termination

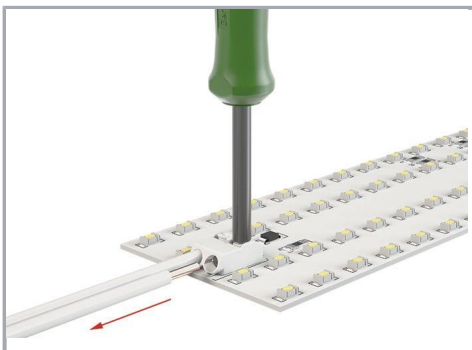

Insert/remove fine-stranded conductors by lightly pressing on push-button, e.g., via optional operating tool (206-860).

Subject to changes. Please also observe the further product documentation!